

CHAPTER 8

Digital Data Bus Acquisition Formatting Standard

8.1	General.....	8-1
8.2	Word Structure	8-1
8.2.1	Field Definition.....	8-1
8.2.2	Most Significant Bit.....	8-2
8.2.3	Bus/Group Identification Label	8-2
8.2.4	Content Identification Label	8-2
8.2.5	Information Content Field.....	8-2
8.2.6	Fill Words	8-3
8.2.7	Content Identification Label	8-3
8.2.8	Cyclic Redundancy Check.....	8-3
8.3	Time Words	8-3
8.4	Composite Output.....	8-3
8.5	Single Bus Track Spread Recording Format	8-4
8.6	MIL-STD-1553	8-4
8.6.1	Definitions.....	8-5
8.6.2	Source Signal	8-5
8.6.3	Word Structure.....	8-6
8.6.4	Time Words	8-7
8.7	ARINC 429	8-8
8.7.1	Definitions.....	8-8
8.7.2	Source Signal	8-8
8.7.3	Word Structure.....	8-8
8.7.4	Time Words	8-10

List of Figures

Figure 8-1.	Composite Frame Structure	8-4
Figure 8-2.	System Block Diagram	8-5
Figure A-1.	Multiple Tape Track Spread Format (4-Track Spread Example)	A-2

List of Tables

Table 8-1.	Word Construction.....	8-1
Table 8-2.	MIL-STD-1553 Formatted Word Construction.....	8-6
Table 8-3.	ARINC 429 Formatted Word Construction	8-9
Table 8-4.	ARINC Bit to Formatted Word Bit Mapping	8-10

This page intentionally left blank.

Acronyms

ARINC	Aeronautical Radio, Incorporated
CRC	cyclic redundancy check
FCS	frame check sequence
MIL-STD	Military Standard
msb	most significant bit
PCM	pulse code modulation
RNRZ-1	randomized non-return-to-zero-level

This page intentionally left blank.

CHAPTER 8

Digital Data Bus Acquisition Formatting Standard

8.1 General

This standard describes output data formats for the acquisition of all the traffic flowing on various digital data buses. The formats permit the capture of data from multiple data buses within a single system. Other constraints, such as radio frequency bandwidth and recording parameters, will dictate the actual number of buses processed by a single system. Subsection [8.4.g](#) provides a standard for composite telemetry pulse code modulation (PCM) format.

Although specifically designed to satisfy the requirements of 100% Military Standard (MIL-STD) 1553 bus and Aeronautical Radio, Incorporated (ARINC) 429 channel acquisition, the formatting provisions of this standard may be used in other applications when the data source and content are similar enough to permit easy adaptation. Users should contact the appropriate range to ensure any adaptations are compatible with that range.

In addition to the total data capture technique and format presented in this chapter, “Selected Measurement” methods are available to acquire less than 100% of bus data. Selected Measurement methods result in PCM formats conforming to [Chapter 4](#) and fall outside the scope of this chapter.

This chapter presents the general requirements for data formatting followed by individual sections addressing specifics pertaining to MIL-STD-1553 and ARINC 429 respectively.

8.2 Word Structure

This section describes the general word structure to be used for the formatted output. Specific word structures and definitions are provided as part of each bus/channel subsection.

8.2.1 Field Definition

The formatted data shall be a 24-bit word constructed as shown in [Table 8-1](#).

Table 8-1. Word Construction																																														
Bit Position																																														
1	2	3	4	5	6	7	8	9	10	11	12	•	•	•	21	22	23	24																												
P	A	R	I	T	Y	<table style="width: 100%; border-collapse: collapse;"> <tr> <td style="border-right: 1px solid black; padding: 5px;">Bus / Group Ident Label</td> <td style="padding: 5px;">Content Ident Label</td> <td style="padding: 5px;">I N F O R M A T I O N Content</td> </tr> <tr> <td colspan="3" style="padding: 5px;">Or</td> </tr> <tr> <td style="border-right: 1px solid black; padding: 5px;">Bus Ident Label</td> <td colspan="2" style="padding: 5px;">A. Field Definition</td> </tr> </table>														Bus / Group Ident Label	Content Ident Label	I N F O R M A T I O N Content	Or			Bus Ident Label	A. Field Definition																			
Bus / Group Ident Label	Content Ident Label	I N F O R M A T I O N Content																																												
Or																																														
Bus Ident Label	A. Field Definition																																													

Bit				Bit				
1	2	3	4	1	2	3	4	
0	0	0	0	1	0	0	0	Bus /Group 9
0	0	0	1	1	0	0	1	Bus /Group 10
0	0	1	0	1	0	1	0	Bus /Group 11
0	0	1	1	1	0	1	1	Bus /Group 12
0	1	0	0	1	1	0	0	Bus /Group 13
0	1	0	1	1	1	0	1	Bus /Group 14
0	1	1	0	1	1	1	0	Bus /Group 15
0	1	1	1	1	1	1	1	Bus /Group 16
B. Bus/Group Identification Label Definition; Bits (1) 2, 3, & 4								
Bit				Bit				
5	6	7	8	5	6	7	8	
1	1	1	1	0	1	1	1	Time - High Order
1	1	1	0	0	1	1	0	Time - Low Order
1	1	0	1	0	1	0	1	Time - Microsecond
1	1	0	0	0	1	0	0	Application Specific
1	0	1	1	0	0	1	1	User Defined
1	0	1	0	0	0	1	0	User Defined
1	0	0	1	0	0	0	1	Fill Word
1	0	0	0	0	0	0	0	Buffer Overflow
C. Content Identification Label Definition; Bits 5, 6, 7, & 8								

8.2.2 Most Significant Bit

The most significant bit (msb) (bit 1) of each formatted word may optionally be an odd parity bit generated for the resulting formatted word or an additional bit appended to the bus/group identification label as described in Subsection [8.2.3](#).

8.2.3 Bus/Group Identification Label

Each word shall also carry a bus or group identification label as shown in [Table 8-1](#). For this application, a bus refers to a MIL-STD-1553 bus (or dual redundant bus pair) and a group refers to a collection of up to four ARINC 429 channels. The bus/group identification label may optionally be three or four bits in length dependent on the exercise of the option to use or not use a parity bit. If not used, the parity bit, or bit 1, is appended to the bus/group identification label to increase the bus count from a maximum of eight (3 bits) to a maximum of 16 (4 bits).

8.2.4 Content Identification Label

Each incoming bus word, auxiliary/user input, or time word shall be appropriately labeled with a 4-bit content identification label (see [Table 8-1](#)). Content identification labels are specific to each bus type and are detailed in later sections.

8.2.5 Information Content Field

Data extracted from the data bus shall maintain bit order integrity and be inserted into the information content field as specified for each bus type. Transposing or reordering of the bits is not permitted.

8.2.6 Fill Words

Fill words, required to maintain continuous PCM output, shall have the following sequence as the information content pattern:

1010 1010 1010 1010 (AAAA hexadecimal)

8.2.7 Content Identification Label

The content identification label indicating buffer overflow (0000) and appropriate bus/group identification label tag shall be appended to the first word placed into the buffer after the buffer becomes available for data storage. This word should be an extra word, not the next available piece of data. Bits 9 through 24 are available for system-level diagnostics and are not specified here. Tagging in this manner marks the point of data discontinuity and preserves the integrity of the next piece of data.

8.2.8 Cyclic Redundancy Check

Cyclic redundancy check (CRC) is a very powerful technique for obtaining data quality. An optional CRC word may be appended as the last positional word of each PCM frame (see [Figure 8-1](#)). The CRC word shall be composed of parity and/or bus/group identification label, content identification label, and 16 bits of a frame check sequence (FCS). The FCS shall fill the information content field (bits 9 - 24). The following CRC-16 polynomial shall be used to generate the FCS. None of the 24 bits making up the entire CRC word shall be used in the calculation of the 16-bit FCS.

CRC-16 polynomial: $X^{16} + X^{15} + X^2 + 1$

 <p>NOTE</p>	<p>Exercise care when assigning bus identification and content identification label codes to the CRC word. Although a positional word in the frame, legacy-processing algorithms may falsely identify the information if one of the bus data labels (1111 - 1000) is used as the content identification label.</p>
--	--

8.3 Time Words

The following describes the structure and use of time words within the formatted output.

The time words dedicated to providing timing information are defined in [Chapter 4](#). These time words are designated as high-order time, low-order time, and microsecond time. The MIL-STD-1553 bus data acquisition applications use an optional fourth time word, designated as response time. The response time word has the same structure as the microsecond time word. Time word structure shall follow the 16-bit per-word format shown in [Chapter 4](#), Figure 4-4, and be placed into the information content field (bits 9 through 24) in bit order.

8.4 Composite Output

This section describes the characteristics for a singular composite output signal.

- The composite, continuous output shall conform to the requirements for Class 2 PCM as stated in [Chapter 4](#).
- The data shall be transmitted msb (bit 1) first.
- The bit rate is dependent on several factors, including bus loading and auxiliary inputs, and shall be set to a fixed rate sufficient to preclude any loss of data.

- d. The order of bus words must remain unaltered except in the case of a buffer overflow.
- e. The frame length shall be fixed and shall be > 128 words and < 512 words including the frame synchronization word.

 <p>NOTE</p>	<p>Recording or other output systems that require constant bit rate inputs due to lack of buffering may require a larger frame than is necessary to contain the data. In this case, additional fill words may be used to increase the frame size to match the desired bit rate.</p>
--	---

- f. The frame synchronization word shall be fixed and 24 consecutive bits in length. The pattern, also shown in [Chapter 4](#) Appendix 4-A, Table A-1, is:

1111 1010 1111 0011 0010 0000 (FAF320 hexadecimal).

- g. A frame structure employing frame time is recommended but optional. If frame time is used, the frame structure shall consist of the frame synchronization word, followed by the high-order time word, followed by the low-order time word, followed by the microsecond time word, followed by the data words from all sources making up the composite signal up to the frame length specified in item [e](#) above (also see [Figure 8-1](#)). If frame time is not used, the frame synchronization word shall be followed immediately by the data words. If a CRC word is not used, the last word in the frame is data word N.

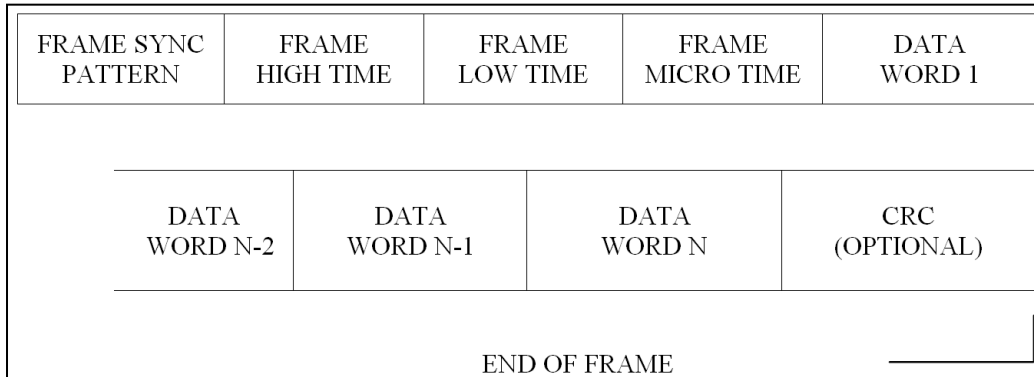
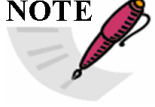

Figure 8-1. Composite Frame Structure

 <p>NOTE</p>	<p>Exercise additional care in data processing and reduction if the last word in a composite stream is a MIL-STD-1553 command word. The associated message time tag will not appear until <u>after</u> the synchronization and time words in the next frame.</p>
--	--

8.5 Single Bus Track Spread Recording Format

This information has been moved to [Appendix 8-A](#) for historical preservation and is no longer recommended for new applications.

8.6 MIL-STD-1553

This section describes specific formatting requirements for the 100% acquisition of MIL-STD-1553 bus information.

8.6.1 Definitions

- a. Bus Monitor. The terminal assigned the task of receiving bus traffic and extracting all information to be used at a later time.
- b. Data Bus. All hardware including twisted shielded pair cables, isolation resistors, and transformers required to provide a single data path between the bus controller and all associated remote terminals.
- c. Dual Redundant Data Bus. The use of two data buses to provide multiple paths between the subsystems.
- d. Bus Loading. The percentage of time the data bus is active.
- e. Maximum Burst Length. The maximum length of a continuous burst of messages with minimum length message gaps.
- f. Bus Error. A condition that violates the definition of MIL-STD-1553 word structure. Conditions such as synchronization, Manchester, parity, non-contiguous data word, and bit count/word errors are all considered word type errors. System protocol errors such as incorrect word count/message and illegal mode codes are not considered bus errors.

8.6.2 Source Signal

The source of data is a signal conforming to MIL-STD-1553. Format provisions are made for a dual redundant data bus system. The interface device performing the data acquisition shall be configured as a bus monitor. [Figure 8-2](#) depicts in block diagram form the concept of 100% MIL-STD-1553 bus data acquisition.

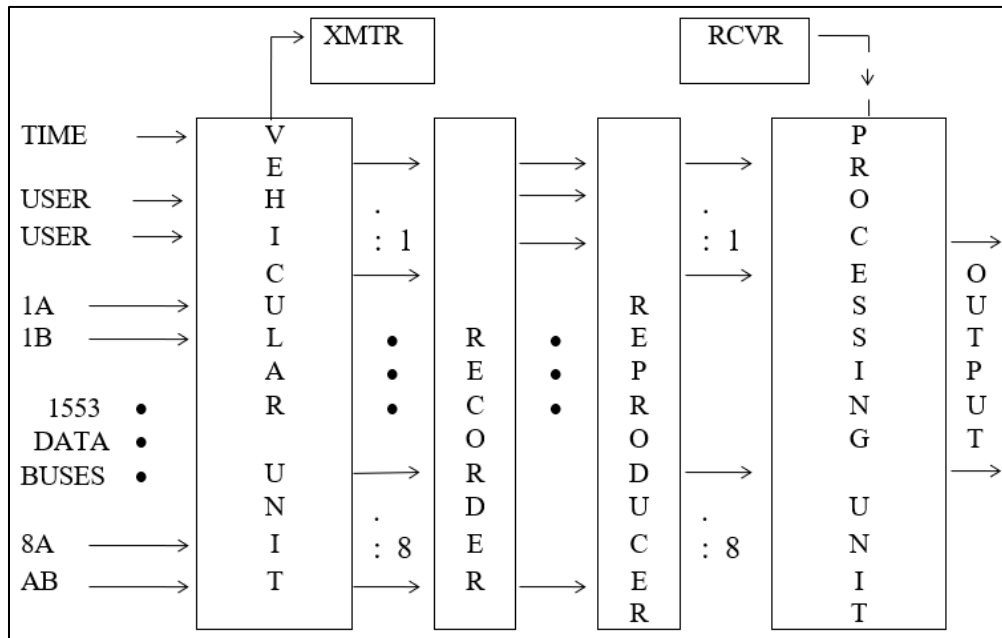
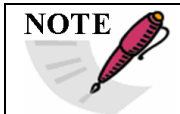

Figure 8-2. System Block Diagram



NOTE In the design of the interface to the MIL-STD-1553 bus, it may be necessary to include buffers to prevent loss of data and to conserve bandwidth. The

	buffer size is influenced by bus loading, maximum burst length, output bit rate, recording parameters, time tagging, and auxiliary inputs.
--	--

8.6.3 Word Structure

This section describes the specific word structure provisions to be used for MIL-STD-1553 bus formatted output.

- a. The formatted data shall be a 24-bit word constructed as shown in [Table 8-1](#) and [Table 8-2](#).
- b. The information extracted from the MIL-STD-1553 bus shall have the synchronization pattern and parity bit removed.
- c. Each incoming MIL-STD-1553 word (Command, Status, or Data), auxiliary input, or time word shall be appropriately labeled with a 4-bit Content Identification Label as described in [Table 8-1](#) and [Table 8-2](#).
- d. Data extracted from the MIL-STD-1553 bus shall maintain bit order integrity in the information field for a command, status, data, and error word. Bit position 4 in the MIL-STD-1553 bus word shall be placed into bit position 9 in the formatted data word. The remaining bits of the MIL-STD-1553 bus word shall be placed in successive bit positions in the formatted data word. Transposing or reordering of the bits is not permitted.
- e. For bus errors as defined in item [f](#) of Subsection [8.6.1](#) (Error A - 1100 or Error B - 1000), the synchronization pattern and the parity bit are removed as stated in item [b](#) above. The Information Content bits, 9 - 24, of the formatted word shall contain the resulting 16-bit pattern extracted from the bus.

Table 8-2. MIL-STD-1553 Formatted Word Construction																											
BIT POSITION																											
1	2	3	4	5	6	7	8	9	10	11	12	•	•	•	21	22	23	24									
P A R I T Y	BUS IDENT LABEL							CONTENT IDENT LABEL													I N F O R M A T I O N C O N T E N T						
OR		BUS IDENT LABEL																									
a. Field Definition																											

BIT				BIT					
1	2	3	4	1	2	3	4		
0	0	0	0	BUS 1	1	0	0	0	BUS 9
0	0	0	1	BUS 2	1	0	0	1	BUS 10
0	0	1	0	BUS 3	1	0	1	0	BUS 11
0	0	1	1	BUS 4	1	0	1	1	BUS 12
0	1	0	0	BUS 5	1	1	0	0	BUS 13
0	1	0	1	BUS 6	1	1	0	1	BUS 14
0	1	1	0	BUS 7	1	1	1	0	BUS 15
0	1	1	1	BUS 8	1	1	1	1	BUS 16

b. MIL-STD-1553 Bus/Group Identification Label Definition; Bits (1) 2, 3, & 4

BIT				BIT					
5	6	7	8	5	6	7	8		
1	1	1	1	COMMAND A	0	1	1	1	TIME - HIGH ORDER
1	1	1	0	STATUS A	0	1	1	0	TIME - LOW ORDER
1	1	0	1	DATA A	0	1	0	1	TIME - MICROSECOND
1	1	0	0	ERROR A	0	1	0	0	TIME - RESPONSE
1	0	1	1	COMMAND B	0	0	1	1	USER DEFINED
1	0	1	0	STATUS B	0	0	1	0	USER DEFINED
1	0	0	1	DATA B	0	0	0	1	FILL WORD
1	0	0	0	ERROR B	0	0	0	0	BUFFER OVERFLOW

NOTE:
A = primary channel of the dual redundant bus; B = secondary channel

c. MIL-STD-1553 Content Identification Label Definition; Bits 5, 6, 7, & 8

8.6.4 Time Words

8.6.4.1 Time Tagging

If time tagging of the occurrence of MIL-STD-1553 messages is necessary to satisfy user requirements, the first command word of the message shall be time tagged. The time words shall immediately follow the first command word in the following order: high-order time, low-order time, and microsecond time.

8.6.4.2 Response Time Word

The optional response time word shall have one-microsecond resolution and shall indicate the response time of the data bus. The response time word shall immediately precede the status word associated with it.

	<p>NOTE</p> <p>If the response time function is not used, Content Identification Label 0100 may be assigned to user-defined inputs.</p>
---	--

8.7 ARINC 429

This section describes specific formatting requirements for the 100% acquisition of ARINC 429 channel information.

8.7.1 Definitions

- a. Monitor. The receiver or sink assigned the task of receiving bus traffic and extracting all information to be used at a later time.
- b. Data Bus. All hardware including twisted shielded pair cables, required to provide a single data path between the transmitter or source and the associated receivers or sinks.
- c. Channel Error. Conditions detected that violate the definition of ARINC 429 word structure as specified in ARINC specifications 429P1,¹ 429P2,² and 429P3.³ Conditions such as parity and bit count/word errors are all considered among word type errors. System protocol errors are not considered bus errors.

8.7.2 Source Signal

The source of data is a signal conforming to ARINC 429. Format provisions are made for up to 64 channels. The interface device performing the data acquisition shall be configured as a monitor. In principle, [Figure 8-2](#) depicts in block diagram form the concept of 100% bus data acquisition.

8.7.3 Word Structure

The following descriptions contain specific word structure provisions to be used for the ARINC 429 formatted output.

- a. The formatted data shall be a 24-bit word constructed as shown in [Table 8-1](#) and [Table 8-3](#).
- b. Each incoming ARINC 429 word, auxiliary input, or time word shall be appropriately labeled with a 4-bit Content Identification Label as described in [Table 8-1](#) and [Table 8-3](#).
- c. The format provides for addressing of up to 64 channels. Each Bus/Group Identification Label (designated GROUP X) may be associated with up to 4 independent ARINC 429 channels through the use of a High and Low Syllable technique described in item [d](#) below and shown in [Table 8-4](#).
- d. Data extracted from the ARINC 429 channel shall maintain bit order integrity in the Information Content field. Each ARINC 429 word is 32 bits in length. To accommodate this word length within the described format, each ARINC word is divided into two segments, each 16 bits in length. These segments will be referred to as ARINC High Syllable and ARINC Low Syllable. [Table 8-4](#) describes the mapping of the 32-bit

¹ ARINC. *Digital Information Transfer System (DITS), Part 1, Functional...* 429P1-19. 21 January 2019. Retrieved 17 July 2024. Available for purchase at <https://aviation-ia.sae-itc.com/product-categories/arinc-standards/400-series>.

² ARINC. *Digital Information Transfer System (DITS), Part 2, Discrete...* 429P2-17. 31 July 2019. Retrieved 17 July 2024. Available for purchase at <https://aviation-ia.sae-itc.com/product-categories/arinc-standards/400-series>.

³ ARINC. *Mark 33 Digital Information Transfer System (DITS) – Part 3 – File Data...* 24 June 2009. Retrieved 17 July 2024. Available at <https://aviation-ia.sae-itc.com/product-categories/arinc-standards/400-series>.

ARINC 429 word into the Information Content bits (9 - 24) of the ARINC High and Low Syllable words. Transposing or reordering of the bits is not permitted.

- e. For channel errors defined in item [c](#) of Subsection [8.7.1](#), the following procedure shall be followed. An error word shall be generated using the appropriate bus/group identification label and 0100 as the content identification label. Bits 9-12 shall contain the content identification label code associated with the appropriate ARINC high syllable channel, bits 13 - 16 shall contain the content identification label for the ARINC low syllable associated with that channel, and bits 17 - 24 are available for system-level diagnostics and are not specified here. The next occurrence of that bus/group identification label coupled with those ARINC high and low syllable content identification labels shall contain the respective data extracted from the channel that was deemed to be in error. The information content bits, 9 - 24, of the formatted word shall contain the resulting 16-bit pattern syllables as extracted from the channel.

Table 8-3. ARINC 429 Formatted Word Construction

BIT POSITION																			
1	2	3	4	5	6	7	8	9	10	11	12	•	•	•	21	22	23	24	
P A R I T Y	GROUP IDENT LABEL			CONTENT IDENT LABEL				INFORMATION CONTENT											
	OR																		
	GROUP IDENT LABEL																		
a. Field Definition																			
BIT								BIT											
1	2	3	4					1	2	3	4								
0	0	0	0	GROUP 1				1	0	0	0	GROUP 9							
0	0	0	1	GROUP 2				1	0	0	1	GROUP 10							
0	0	1	0	GROUP 3				1	0	1	0	GROUP 11							
0	0	1	1	GROUP 4				1	0	1	1	GROUP 12							
0	1	0	0	GROUP 5				1	1	0	0	GROUP 13							
0	1	0	1	GROUP 6				1	1	0	1	GROUP 14							
0	1	1	0	GROUP 7				1	1	1	0	GROUP 15							
0	1	1	1	GROUP 8				1	1	1	1	GROUP 16							
b. ARINC 429 Bus/Group Identification Label Definition; Bits (1) 2, 3, & 4																			

BIT		BIT	
5	6 7 8	5 6 7 8	
1 1 1 1	High Syllable #4	0 1 1 1	TIME - HIGH ORDER
1 1 1 0	Low Syllable #4	0 1 1 0	TIME - LOW ORDER
1 1 0 1	High Syllable #3	0 1 0 1	TIME - MICROSECOND
1 1 0 0	Low Syllable #3	0 1 0 0	ERROR
1 0 1 1	High Syllable #2	0 0 1 1	USER DEFINED
1 0 1 0	Low Syllable #2	0 0 1 0	USER DEFINED
1 0 0 1	High Syllable #1	0 0 0 1	FILL WORD
1 0 0 0	Low Syllable #1	0 0 0 0	BUFFER OVERFLOW

c. ARINC 429 Content Identification Label Definition; Bits 5, 6, 7, & 8

Table 8-4. ARINC Bit to Formatted Word Bit Mapping															
9	10	11	12	13	14	15	16	17	18	19	20	21	22	23	24
a. Information Content field bits															
32	31	30	29	28	27	26	25	24	23	22	21	20	19	18	17
b. ARINC High Syllable bit mapping															
16	15	14	13	12	11	10	9	8	7	6	5	4	3	2	1
c. ARINC Low Syllable bit mapping															

8.7.4 Time Words

If time tagging of the occurrence of ARINC 429 messages is necessary to satisfy user requirements, the time words shall immediately follow the ARINC Low Syllable word in the following order:

- a. High-order time;
- b. Low-order time;
- c. Microsecond time.

APPENDIX 8-A

Single Bus Track Spread Recording Format

The information included in this appendix is not intended to be used in new designs or applications. This section of the original standard was included to provide a means of recording the formatted data on longitudinal tape recorders. This appendix is included in the standard for historical purposes only.

A.1. Single Bus Track Spread Recording Format

This section describes the characteristics of a single bus recording technique using a multiple tape track spread output format.

- a. The target tape recorder/reproducer for a track spread format is a longitudinal fixed-head machine described in [Annex A-2](#) and not one employing parallel high-density digital recording or rotary head recording characteristics.
- b. The code generated for longitudinal tape recording shall be randomized non-return-to-zero-level (RNRZ-L) or bi-phase-level as described in [Chapter 12](#).

	Bit rates less than 200,000 bits per second are not recommended when using RNRZ-L.
---	--

- c. To extend recording time while still acquiring 100% of bus data, a multiple track spread recording technique is presented as follows.
 - (1) When necessary to use more than one tape recording track (to extend record time), separate PCM streams shall be created and delayed by $24/TK$ bits with respect to each other, where TK represents the number of tape tracks used for a given bus.
 - (2) When multiple track-spread recording is required, the track spread shall be on a bus basis such as bus number 1 spread over four tracks, and bus number 2 spread over two tracks. The maximum number of tracks per bus shall be limited to four.

	Consideration should be given to spread track assignment. All tracks associated with a given bus should be recorded on the same head stack.
---	---

- (3) Each stream shall have a frame synchronization pattern 24 bits in length, conforming to item [f](#) of Subsection [8.4](#).
- (4) The word structure shall be identical to that described in Section [8.2](#).
- (5) The frame length shall be fixed and shall be the same for each track used for a given bus. The frame length shall conform to the requirements of item [e](#) in Subsection [8.4](#).
- (6) The data shall be formatted such that it is transmitted (recorded) msb (bit 1) first.

- (7) The use of a CRC word as described in Subsection 8.2.8 is optional. If used in the track spread application, a CRC word must be generated and appended to each of the PCM frames for that bus.
- (8) A structure employing frame time is recommended but optional. The following describes a four-track spread example using frame time.
 - TK1. The PCM stream designated TK1 shall be constructed as the frame synchronization word, followed by the high-order frame time word, followed by data words (see Figure A-1).

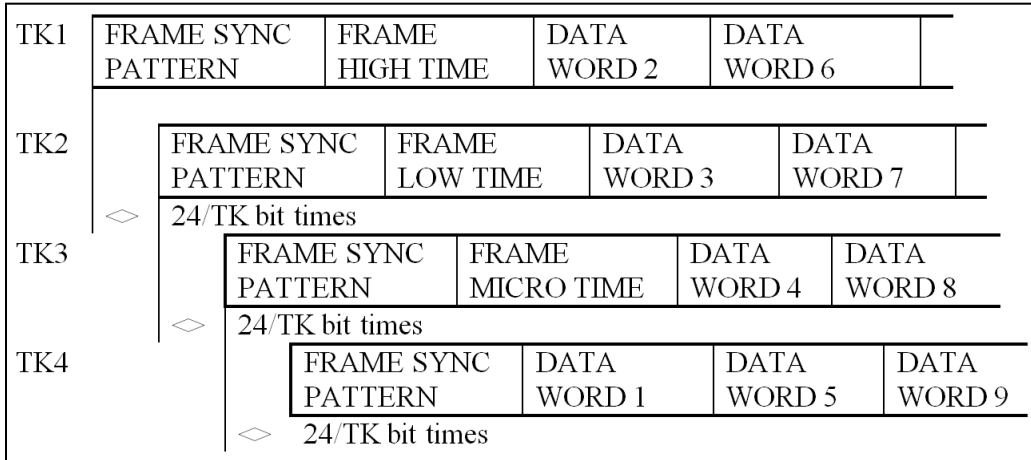
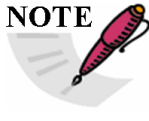
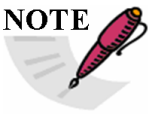

Figure A-1. Multiple Tape Track Spread Format (4-Track Spread Example)

- TK2. The PCM stream designated TK2 shall be constructed as the frame synchronization word, followed by the low-order frame time word, followed by data words.
- TK3. The PCM stream designated TK3 shall be constructed as the frame synchronization word, followed by the microsecond frame time word, followed by data words.
- TK4. The PCM stream designated TK4 shall be constructed as the frame synchronization word, followed by the first data word, followed by other data words.

 <p>NOTE</p>	<p>Schemes using one, two, or three tracks for a given bus shall follow like construction; that is, sequencing through the data track by track. If frame time is not used, data words shall immediately follow the frame synchronization patterns.</p>
--	--

 <p>NOTE</p>	<p>Additional care must be exercised in data processing and reduction if the last word in the final track spread stream is a MIL-STD-1553 command word. The associated message time tag will not appear until after the synchronization and time words in the next frame.</p>
--	---

APPENDIX 8-B

Citations

- ARINC. *Digital Information Transfer System (DITS), Part 1, Functional...* 429P1-19. 21 January 2019. Retrieved 17 July 2024. Available for purchase at <https://aviation-ia.sae-itc.com/product-categories/arinc-standards/400-series>.
- . *Digital Information Transfer System (DITS), Part 2, Discrete...* 429P2-17. 31 July 2019. Retrieved 17 July 2024. Available for purchase at <https://aviation-ia.sae-itc.com/product-categories/arinc-standards/400-series>.
- . *Mark 33 Digital Information Transfer System (DITS) – Part 3 – File Data...* 24 June 2009. Retrieved 17 July 2024. Available at <https://aviation-ia.sae-itc.com/product-categories/arinc-standards/400-series>.

*** * * END OF CHAPTER 8 * * ***