

CHAPTER 11

Recorder Data Packet Format Standard

Changes to This Edition of Chapter 11	11-v
Acronyms	11-vii
Chapter 11. Packet Format Standard	11-1
11.1 General	11-1
11.2 Data Format Definitions	11-1
11.2.1 Common Packet Elements	11-1
11.2.2 PCM Data Packets	11-12
11.2.3 Time Data Packets	11-22
11.2.4 MIL-STD-1553 Packets.....	11-26
11.2.5 Analog Data Packets	11-36
11.2.6 Discrete Data Packets	11-43
11.2.7 Computer-Generated Data Packets	11-45
11.2.8 ARINC-429 Data Packets	11-60
11.2.9 Message Data Packets.....	11-62
11.2.10 Video Packets.....	11-64
11.2.11 Image Packets	11-81
11.2.12 UART Data Packets	11-90
11.2.13 IEEE 1394 Data Packets	11-92
11.2.14 Parallel Data Packet	11-97
11.2.15 Ethernet Data Packets	11-99
11.2.16 Time Space Position Information and Combat Training Systems Data Packets	11-105
11.2.17 Controller Area Network Bus Packets	11-112
11.2.18 Fibre Channel Packets.....	11-115
Appendix 11-A. Definitions	A-1
Appendix 11-B. Citations	B-1

Table of Figures

Figure 11-1. Overall Packet Structure	11-2
Figure 11-2. Packet Trailer for 32-Bit Data Checksum.....	11-4
Figure 11-3. Packet Trailer for 8-Bit Data Checksum.....	11-4
Figure 11-4. Secondary Header Chapter 4 Time	11-10
Figure 11-5. Secondary Header IEEE 1588 Time	11-10
Figure 11-6. Secondary Header ERTC Time	11-10
Figure 11-7. Pulse Code Modulation Packet Channel-Specific Data Format	11-13
Figure 11-8. 32-Bit Alignment Mode Example, 16-Bit Data Words (32-Bit Word Addressing).....	11-19

Figure 11-9.	32-Bit Alignment Mode Example, 16-Bit Data Words (16-Bit Word Addressing).....	11-19
Figure 11-10.	Pulse Code Modulation Intra-Packet Header.....	11-19
Figure 11-11.	DQE PCM Channel-Specific Data, Format 2.....	11-21
Figure 11-12.	Time Packet Channel-Specific Data Format.....	11-22
Figure 11-13.	Time Data-Packet Format, Day Format.....	11-24
Figure 11-14.	Time Data-Packet Format, Day, Month, and Year Format.....	11-24
Figure 11-15.	Format 2 Network Time Packet Channel-Specific Data Format.....	11-26
Figure 11-16.	Format 2 Network Time Packet NTP Time Data.....	11-26
Figure 11-17.	Format 2 Network Time Packet PTP Time Data.....	11-26
Figure 11-18.	MIL-STD-1553 Packet Channel-Specific Data Format.....	11-27
Figure 11-19.	MIL-STD-1553 Intra-Packet Data Header.....	11-28
Figure 11-20.	Block Status Word.....	11-28
Figure 11-21.	Gap Times Word.....	11-30
Figure 11-22.	16PP194 Message Transaction.....	11-31
Figure 11-23.	Military Standard 1553 16PP194 Packet Channel-Specific Data Format.....	11-32
Figure 11-24.	Military Standard 1553 16PP194 Intra-Packet Data Header Format.....	11-33
Figure 11-25.	Military Standard 1553 26-Bit 16PP194 Word.....	11-34
Figure 11-26.	16PP194 Word Format.....	11-36
Figure 11-27.	Analog Packet Channel-Specific Data Word.....	11-37
Figure 11-28.	Discrete Packet Channel Data Word.....	11-43
Figure 11-29.	Discrete Data Format.....	11-44
Figure 11-30.	Discrete Event Intra-Packet Header.....	11-44
Figure 11-31.	Computer-Generated Format 0 Channel-Specific Data Word.....	11-46
Figure 11-32.	Computer-Generated Format 1 Channel-Specific Data Word.....	11-46
Figure 11-33.	Computer-Generated Format 2 Channel-Specific Data Word.....	11-48
Figure 11-34.	Events Recording Period.....	11-49
Figure 11-35.	Recording Event Intra-Packet Header.....	11-51
Figure 11-36.	Recording Event Entry Layout.....	11-52
Figure 11-37.	Format Showing Root Index Packet.....	11-54
Figure 11-38.	Computer-Generated Format 3 Channel-Specific Data Word.....	11-54
Figure 11-39.	Recording Index Intra-Packet Header.....	11-55
Figure 11-40.	Recording Node Index Entry Layout.....	11-57
Figure 11-41.	Computer-Generated Format 4 Channel-Specific Data Word.....	11-58
Figure 11-42.	ARINC-429 Packet Channel-Specific Data Word.....	11-61
Figure 11-43.	Intra-Packet Data Header Format.....	11-61
Figure 11-44.	Complete Message Channel-Specific Data Word.....	11-62
Figure 11-45.	Segmented Message Channel-Specific Data Word.....	11-63
Figure 11-46.	Message Data Intra-Packet Header.....	11-63
Figure 11-47.	Intra-Packet Data Header Format.....	11-64
Figure 11-48.	Video Packet Channel-Specific Data Word.....	11-66
Figure 11-49.	Format 0 MPEG-2/H.264 Video Frame Format, 16-Bit Little-Endian Aligned.....	11-68
Figure 11-50.	Format 0 MPEG-2/H.264 Video Frame Format, 16-Bit Big-Endian (Native) Aligned.....	11-68

Figure 11-51.	Video Packet, Format 0 Intra-Packet Header	11-68
Figure 11-52.	MPEG-2 Channel-Specific Data Word.....	11-70
Figure 11-53.	Video Packet, Format 1 Intra-Packet Header	11-73
Figure 11-54.	AVC/H.264 Channel-Specific Data Word.....	11-74
Figure 11-55.	Video Packet, Format 2 Intra-Packet Header	11-76
Figure 11-56.	MJPEG Video packet Channel-Specific Data Word	11-78
Figure 11-57.	MJPEG Video Intra-Packet Header	11-78
Figure 11-58.	MJPEG 2000 Video Packet Channel-Specific Data Word.....	11-80
Figure 11-59.	MJPEG Video Intra-Packet Header	11-81
Figure 11-60.	Image Packet Channel-Specific Data Word	11-82
Figure 11-61.	Image Data Intra-Packet Header, Format 0	11-83
Figure 11-62.	Still Imagery Packet Channel-Specific Data Word	11-84
Figure 11-63.	Still Imagery Intra-Packet Header	11-85
Figure 11-64.	Dynamic Imagery Packet Channel-Specific Data Word	11-86
Figure 11-65.	Dynamic Imagery Intra-Packet Header	11-89
Figure 11-66.	UART Packet Channel-Specific Data Word.....	11-90
Figure 11-67.	UART Data Intra-Packet Header	11-91
Figure 11-68.	Intra-Packet Data Header Format	11-91
Figure 11-69.	IEEE 1394 Channel-Specific Data Word	11-92
Figure 11-70.	IEEE 1394 Intra-Packet Header.....	11-93
Figure 11-71.	IEEE 1394 Event Data Word.....	11-93
Figure 11-72.	IEEE 1394 Channel-Specific Data Word, Format 1	11-95
Figure 11-73.	IEEE 1394 Format 1 Intra-Packet Header	11-95
Figure 11-74.	Intra-Packet Data Header - Message ID Word	11-96
Figure 11-75.	Parallel Packet Channel-Specific Data Word	11-97
Figure 11-76.	Parallel Data, Up to 8-Bit-Wide Words.....	11-98
Figure 11-77.	Parallel Data, 9-Bit to 16-Bit-Wide Words.....	11-98
Figure 11-78.	Parallel Data (Example: 28-Bit-Wide Words).....	11-98
Figure 11-79.	DCRsi Scan, 9-Auxiliary Data Byte + 4326 Bytes.....	11-99
Figure 11-80.	Ethernet Data Packet Format 0 Channel-Specific Data Word.....	11-100
Figure 11-81.	Ethernet Data Format 0 Intra-Packet Header.....	11-101
Figure 11-82.	Intra-Packet Frame ID Word	11-101
Figure 11-83.	Ethernet Data Packet Format 1 Channel-Specific Data Word.....	11-104
Figure 11-84.	Ethernet Data Format 1 Intra-Packet Header.....	11-104
Figure 11-85.	Intra-Packet Data Header.....	11-105
Figure 11-86.	NMEA-RTCM Packet Channel-Specific Data Word	11-107
Figure 11-87.	NMEA-RTCM Intra-Packet Time Stamp.....	11-107
Figure 11-88.	NMEA-RTCM Intra-Packet Data Header	11-108
Figure 11-89.	EAG ACMI Packet Channel-Specific Data Word.....	11-109
Figure 11-90.	EAG ACMI Data Intra-Packet Time Stamp	11-109
Figure 11-91.	EAG ACMI Intra-Packet Data Header	11-109
Figure 11-92.	ACTTS Packet Channel-Specific Data Word.....	11-111
Figure 11-93.	ACTTS Data Intra-Packet Time Stamp	11-111
Figure 11-94.	ACTTS Data Intra-Packet Data Header.....	11-112
Figure 11-95.	Complete CAN Bus Format 0 Channel-Specific Data Word	11-113
Figure 11-96.	CAN Bus Data Format 0 Intra-Packet Data Header	11-113

Figure 11-97.	Intra-Packet Message Header	11-113
Figure 11-98.	Intra-Packet ID Word.....	11-114
Figure 11-99.	CAN Bus Format 0 Message	11-114
Figure 11-100.	Fibre Channel Data Packet Channel-Specific Data Word	11-115
Figure 11-101.	Fibre Channel Data Format 0 Intra-Packet Header.....	11-116
Figure 11-102.	Fibre Channel Data Format 0 Intra-Packet Frame ID Word.....	11-116
Figure 11-103.	Fibre Channel Data Packet Channel-Specific Data Word Format.....	11-119
Figure 11-104.	Fibre Channel Data Format 1 Intra-Packet Header.....	11-119
Figure 11-105.	Fibre Channel Data Format 1, (FC-FS Layer) Intra-Packet Frame Status Word.....	11-119

Table of Tables

Table 11-1.	General Packet Structure.....	11-2
Table 11-2.	32-Bit Packet Format Layout.....	11-3
Table 11-3.	Packet Requirements.....	11-4
Table 11-4.	Data Type Names and Descriptions.....	11-6
Table 11-5.	General PCM Data Packet, Format 1	11-12
Table 11-6.	PCM Data-Unpacked (16-Bit Alignment Mode) Sample Packet	11-15
Table 11-7.	PCM Data-Unpacked (32-Bit Alignment Mode) Sample Packet	11-15
Table 11-8.	PCM Data-Packed (16-Bit Alignment Mode) Sample Packet.....	11-16
Table 11-9.	PCM Data-Packed (32-Bit Alignment Mode) Sample Packet.....	11-17
Table 11-10.	PCM Data-Throughput (16-Bit Alignment Mode) Sample Packet	11-18
Table 11-11.	PCM Data-Throughput (32-Bit Alignment Mode) Sample Packet	11-18
Table 11-12.	General PCM Data Packet, Format 2.....	11-20
Table 11-13.	PCM Data-Throughput (16-Bit Alignment Mode) Sample Packet, Format 2	11-21
Table 11-14.	PCM Data-Throughput (32-Bit Alignment Mode) Sample Packet, Format 2	11-22
Table 11-15.	General Time Data Packet, Format 1	11-23
Table 11-16.	Units of Measure.....	11-25
Table 11-17.	General Time Data Packet, Format 1	11-25
Table 11-18.	MIL-STD-1553 Data Packet, Format 1 Basic Layout	11-27
Table 11-19.	MIL-STD-1553 Data Packet, Format 1	11-30
Table 11-20.	MIL-STD-1553 16PP194 Data Packet Basic Layout	11-32
Table 11-21.	MIL-STD-1553 16PP194 Data Packet	11-33
Table 11-22.	Generic Analog Data Packet, Format 1	11-36
Table 11-23.	Analog Data Packet-Unpacked Mode, msb Padding.....	11-41
Table 11-24.	Analog Data Packet-Unpacked Mode, lsb Padding.....	11-41
Table 11-25.	Analog Data Packet-Packed Mode Packet.....	11-42
Table 11-26.	General Discrete Data Packet, Format 1	11-43
Table 11-27.	Discrete Data Packet Format	11-45
Table 11-28.	General Computer-Generated Data Packet Format	11-45
Table 11-29.	General Recording Event Packet Format.....	11-51
Table 11-30.	General Recording Root Index Packet.....	11-55
Table 11-31.	Recording Root Index Entry Layout.....	11-56

Table 11-32.	General Recording Node Index Packet.....	11-57
Table 11-33.	SHA2-256 Checksum Packet Layout	11-59
Table 11-34.	Currently Selected Channel Layout	11-59
Table 11-35.	ARINC-429 Data Packet Format	11-60
Table 11-36.	Message Data Packet Format.....	11-62
Table 11-37.	General MPEG-2/H.264 Video Packet, Format 0	11-65
Table 11-38.	Format 0 MPEG-2/H.264 Video Data Packet.....	11-69
Table 11-39.	General MPEG-2 Video Packet, Format 1	11-70
Table 11-40.	General AVC/H.264 Video Packet, Format 2	11-73
Table 11-41.	MJPEG Video Packet, Format 3	11-77
Table 11-42.	MJPEG Video Packet, Format 4.....	11-79
Table 11-43.	Image Packet, Format 0	11-81
Table 11-44.	Still Imagery Packet, Format 1	11-83
Table 11-45.	Dynamic Imagery Packet, Format 1	11-85
Table 11-46.	UART Data Packet Format.....	11-90
Table 11-47.	IEEE 1394 Data Packet, Format 0	11-92
Table 11-48.	IEEE 1394 Data Packet, Format 1	11-95
Table 11-49.	Parallel Data Packet, Format 0.....	11-97
Table 11-50.	Ethernet Data Packet, Format 0	11-99
Table 11-51.	Ethernet Data Format 1	11-102
Table 11-52.	Comparison of Normal Ethernet and ARINC-664 Frames.....	11-103
Table 11-53.	NMEA-RTCM Data Packet Format	11-106
Table 11-54.	EAG ACMI Data Packet Format	11-108
Table 11-55.	ACTTS Data Packet Format	11-110
Table 11-56.	Controller Area Network Bus Data Packet, Format 0	11-112
Table 11-57.	Fibre Channel Data Packet, Format 0.....	11-115
Table 11-58.	Fibre Channel Data Packet, Format 1	11-118

Changes to This Edition of Chapter 11

No changes to Chapter 11 were included in developing 106-20.

This page intentionally left blank.

Acronyms

μs	microsecond
ACTTS	Air Combat Test and Training System
ARINC	Aeronautical Radio, Incorporated
BC	bus controller
CAN	controller area network
CBR	constant bit rate
CIU	communication interface unit
CSDW	channel-specific data word
CTS	Combat Training Systems
DCRsi	Digital Cartridge Recording System - Incremental
DQE	Data Quality Encapsulation
ERTC	extended relative time counter
Gbps	gigabit per second
GHz	gigahertz
GPS	Global Positioning System
IAW	in accordance with
IEC	International Electrotechnical Commission
IEEE	Institute of Electrical and Electronics Engineers
IETF	Internet Engineering Task Force
IP	Internet Protocol
IPDH	intra-packet data header
IPH	intra-packet header
IPMH	intra-packet message header
IPTS	intra-packet time stamp
IRIG	Inter-Range Instrumentation Group
ISO	International Organization for Standards
ITU-T	International Telecommunications Union/Telecommunication Standardization Sector
KB	kilobyte
KITS	Kadena Interim Training System
KLV	key-length-value
LDPC	Low Density Parity Check
lsb	least significant bit
LSLW	least significant long word
MAC	media access control
Mbps	megabit per second
MHz	megahertz
MIL-STD	Military Standard
MISP	Motion Imagery Standards Profile
MPEG	Moving Picture Experts Group
ms	millisecond
msb	most significant bit
MSLW	most significant long word
NTP	Network Time Protocol
PAT	program association table

PCM	pulse code modulation
PCR	program clock reference
PES	program elementary stream
PID	program ID
PMT	program map table
PS	program stream
PTP	Precision Time Protocol
RCC	Range Commanders Council
RIU	remote interface unit
RS	Recommended Standard
RT	remote terminal
RTC	relative time counter
STC	Space Time Code
TCG	time code generator
TMATS	Telemetry Attributes Transfer Standard
TS	transport stream
TSPI	Time Space Position Information
UART	Universal Asynchronous Receiver and Transmitter
UDP	User Datagram Protocol
UTC	Universal Coordinated Time

CHAPTER 11

Packet Format Standard

11.1 General

A large number of unique and proprietary data structures has been developed for specific data recording applications that required unique decoding software programs. The activities of writing unique decoding software, checking the software for accuracy, and decoding the data formats are extremely time-consuming and costly.

Specifically, this packet format standard shall be usable with multiplexing of both synchronous and asynchronous digital inputs such as pulse code modulation (PCM); Military Standard (MIL-STD) 1553 data bus, time, analog, video; Aeronautical Radio, Inc. (ARINC) 429; discrete; and Universal Asynchronous Receiver and Transmitter (UART) containing Recommended Standard (RS)-232/422/485 communication data. This packet standard will allow use of a common set of data interpretation libraries to reduce the cost of producing data analysis systems.

 <p>NOTE</p>	<p>Within this standard, where text, figures, or tables are used to provide descriptions, meaning, and/or explanations, the text shall take precedence over figures and tables.</p>
------------------------------------------------------------------------------------------------------	-------------------------------------------------------------------------------------------------------------------------------------------------------------------------------------

The data format structures (packet header, secondary packet header, channel-specific data word [CSDW], intra-packet data header [IPDH], and packet trailer) described in Section [11.2](#) are defined to have the following bit and byte orientation. The least significant byte shall be transmitted first; the least significant bit (lsb) of each byte shall be transmitted first, with most significant bit (msb) transmitted last; and data is read from the lowest logical address first. This ordering is commonly referred to as “Little Endian.” The packet data shall remain in its native byte order format.

11.2 Data Format Definitions

11.2.1 Common Packet Elements

Data shall have three required parts: a packet header, a packet body, and a packet trailer, and an optional part if enabled, a packet secondary header. A packet will always conform to the structure outlined in [Figure 11-1](#).

- a. A packet has the basic structure shown in [Table 11-1](#). Note that the width of the structure is not related to any number of bytes or bits. This table is merely to represent relative packet elements and their placement within the packet. See [Table 11-2](#) for a diagram of the generic packet format. This table does not depict the bit lengths of each field. Word sizes of 8 bits, 16 bits, and 32 bits are used depending on the data type.

To further clarify the packet layout, [Table 11-2](#) shows the generic packet in a 32-bit, little-endian format, and assumes 16-bit data words and data checksum.

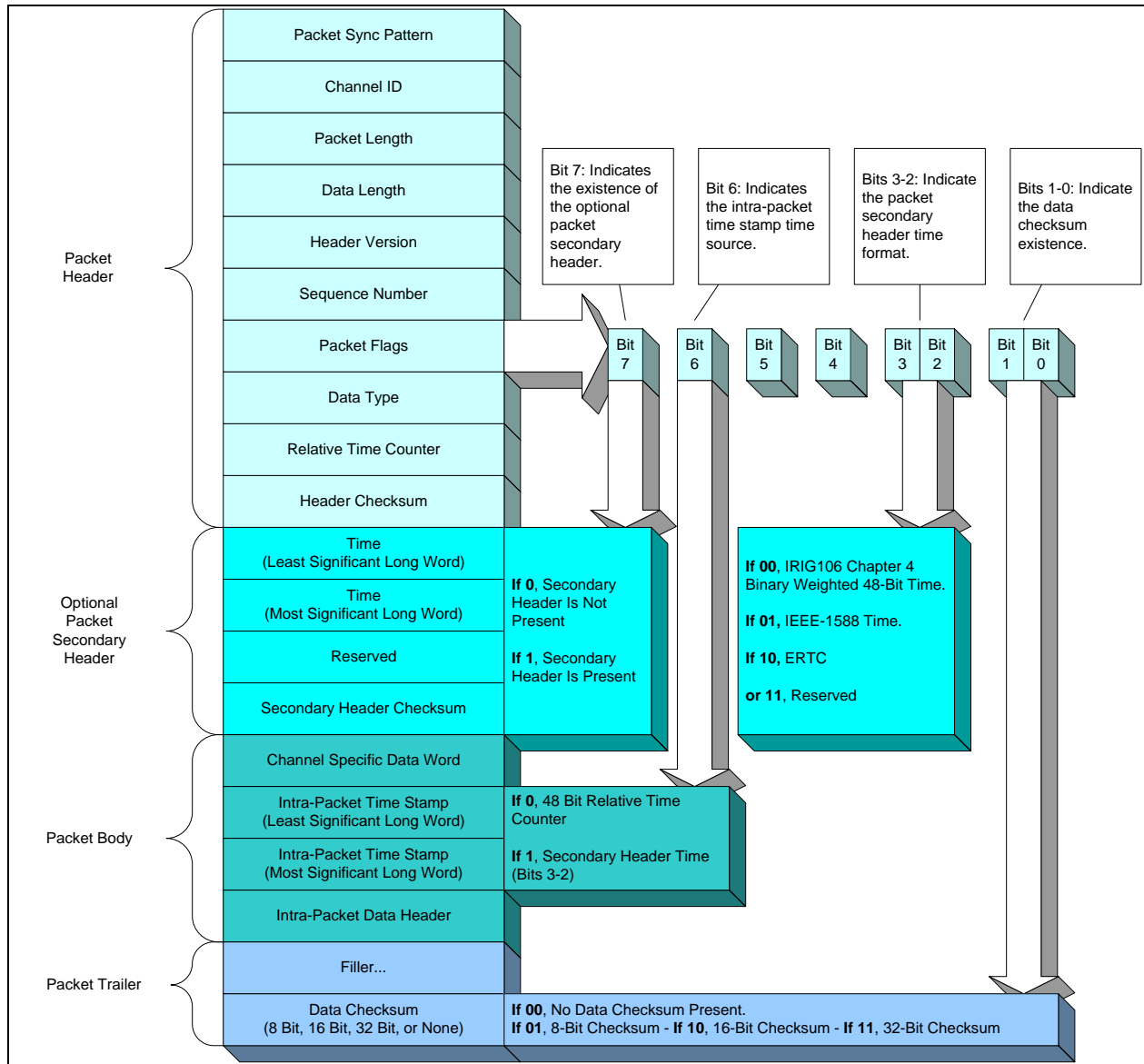

Figure 11-1. Overall Packet Structure

Table 11-1. General Packet Structure	
PACKET SYNC PATTERN	Packet Header
CHANNEL ID	
PACKET LENGTH	
DATA LENGTH	
DATA TYPE VERSION	
SEQUENCE NUMBER	
PACKET FLAGS	
DATA TYPE	
RELATIVE TIME COUNTER	
HEADER CHECKSUM	

TIME	Packet Secondary Header (Optional)
RESERVED	
SECONDARY HEADER CHECKSUM	
CHANNEL-SPECIFIC DATA	Packet Body
INTRA-PACKET TIME STAMP 1	
INTRA-PACKET DATA HEADER 1	
DATA 1	
:	
INTRA-PACKET TIME STAMP N	
INTRA-PACKET DATA HEADER N	
DATA n	Packet Trailer
DATA CHECKSUM	

Table 11-2. 32-Bit Packet Format Layout					
msb				lsb	
31		16 15		0	
CHANNEL ID		PACKET SYNC PATTERN			
PACKET LENGTH					
DATA LENGTH					
DATA TYPE	PACKET FLAGS	SEQUENCE NUMBER	DATA TYPE VERSION	Packet Header	
RELATIVE TIME COUNTER					
HEADER CHECKSUM		RELATIVE TIME COUNTER			
TIME (LEAST SIGNIFICANT LONG WORD [LSLW])					
TIME (MOST SIGNIFICANT LONG WORD [MSLW])					
SECONDARY HEADER CHECKSUM		RESERVED			(Optional) Packet Secondary Header
CHANNEL-SPECIFIC DATA					
INTRA-PACKET TIME STAMP 1					
INTRA-PACKET TIME STAMP 1					
INTRA-PACKET DATA HEADER 1					
DATA 1 WORD 2		DATA 1 WORD 1			
DATA 1 WORD N		:			
INTRA-PACKET TIME STAMP 2					
INTRA-PACKET TIME STAMP 2					
INTRA-PACKET DATA HEADER 2					
DATA 2 WORD 2		DATA 2 WORD 1			
DATA 2 WORD N		:			
:					
INTRA-PACKET TIME STAMP N					
INTRA-PACKET TIME STAMP N					
INTRA-PACKET DATA HEADER N					
DATA N WORD 2		DATA N WORD 1			

DATA N WORD N	:	
[FILLER]		Packet Trailer
DATA CHECKSUM		

Depending on the data type, the size of the data checksum can contain 32 bits, 16 bits, 8 bits, or the checksum can be entirely left out. For a 32-bit data checksum, the packet trailer would be as shown in [Figure 11-2](#).

msb 7	lsb 0	
[Filler]		Packet Trailer
Data Checksum (lsb)		
Data Checksum		
Data Checksum		
Data Checksum (msb)		

Figure 11-2. Packet Trailer for 32-Bit Data Checksum

- b. For an 8-bit data checksum, the packet trailer would be as shown in [Figure 11-3](#).

msb 7	lsb 0	
[Filler]		Packet Trailer
Data Checksum		

Figure 11-3. Packet Trailer for 8-Bit Data Checksum

- c. The size of a single packet may be a maximum of 524,288 (2^{19}) bytes as shown in [Table 11-3](#). This includes the packet header, packet body, packet trailer, and optional packet secondary header if enabled. The only exception to the packet size limit is the Computer-Generated Data Packet, Format 1 setup record, which may be a maximum of 134,217,728 (2^{27}) bytes. Any packet that requires more than 524,288 bytes may generate multiple packets by utilizing the packet sequence counter. Some packet types allow a single data set to span multiple packets if the data set size or time does not fall under packet maximums. The specific mechanism allowing packet data spanning for each data type is described within that data type's section.

Table 11-3. Packet Requirements		
Packet Type	Required	Maximum Packet Size
Computer-Generated Data Packet, Format 1 Setup Record	Yes	134,217,728 bytes
Time Data Packet	Yes	524,288 bytes
All other data type packets with the exception of Computer-Generated Data Packet, Format 1 setup record, time data packets, and Computer-Generated Data Packet, Format 3 recording index (root index)	No	524,288 bytes

Table 11-3. Packet Requirements

Computer-Generated Data Packet, Format 3 recording index (root index)	Yes, if recording events are enabled. No, if recording events are disabled.	524,288 bytes
-----------------------------------------------------------------------	--------------------------------------------------------------------------------	---------------

- d. (Reserved)
- e. All packets that are generated shall contain data. Filler only, idle (as defined by medium or interface) only, or empty packets shall not be allowed.
- f. All reserved bit fields in packet headers or CSDWs shall be set to zero (0x0).
- g. (Reserved)
- h. Once version bits and packet structure bits have been used to indicate a value or setting for each data type and its associated channel, they shall not change for that data type and its associated channel within the operational session (e.g., recording).

11.2.1.1 Packet Header

The length of the packet header is fixed at 24 bytes (192 bits). The packet header is mandatory and shall consist of ten fields, positioned contiguously as shown in [Table 11-2](#) and defined below.

- a. Packet Sync Pattern. These 2 bytes contain a static sync value for every packet. The packet sync pattern value shall be 0xEB25.
- b. Channel ID. These 2 bytes contain a value representing the packet channel ID. All channels in a system must have a unique channel ID for each data source.
 - (1) Multiplexer Source ID. In a distributed multiplexer system, a multiplexer source ID is used to discern each multiplexer in the system. The setup record shall contain a “Number of Source Bits” recorder attribute (R-x\NSB) to specify the number of msbs (from the channel ID) that distinguish the multiplexer source ID. The remaining lsbs of the channel ID field shall be the channel ID for each data source acquired by the multiplexer.
 - (2) Reserved Channel ID. Channel ID 0x0000 is reserved, and as of 106-17 is used to insert only the Computer-Generated Data Packet, Format 1 setup record(s) or the Computer-Generated Data Packet, Format 4 Streaming Configuration records into the composite data stream.
 - (3) Available Channel IDs. All values not comprising the reserved channel ID are available. As of 106-13, when Computer-Generated Data Packet, Formats 0, 2, and 3 reside in a channel with ID 0x0001-0xFFFF, only one packet type shall exist per channel ID.
- c. Packet Length. These 4 bytes contain a value representing the length of the entire packet. The value shall be in bytes and is always a multiple of four (bit 1 and bit 0 shall always be zero). This packet length includes the packet header, packet secondary header (if

enabled), channel-specific data, intra-packet headers (IPHs), data, filler, and data checksum.

- d. **Data Length.** These 4 bytes contain a value representing the valid data length within the packet. This value shall be represented in bytes. Valid data length includes channel-specific data, IPDHs, intra-packet time stamp(s) (IPTS), and data but does not include packet trailer filler and data checksum.
- e. **Data Type Version.** This byte contains a value at or below the release version of the standard applied to the data types in [Table 11-4](#). The value shall be represented by the following bit patterns.

- 0x00 = Reserved
- 0x01 = Initial Release (Range Commanders Council [RCC] 106-04)
- 0x02 = RCC 106-05
- 0x03 = RCC 106-07
- 0x04 = RCC 106-09
- 0x05 = RCC 106-11
- 0x06 = RCC 106-13
- 0x07 = RCC 106-15
- 0x08 = RCC 106-17
- 0x09 = RCC 106-19
- 0x0A through 0xFF = Reserved

Note: References to RCC 106-04 through RCC 106-15 refer to Chapter 10, while RCC 106-17 onward refer to Chapter 11.

Table 11-4. Data Type Names and Descriptions			
Packet Header Value	Data Type Name	Data Type Description	Current Data Type Version
0x00	Computer-Generated Data, Format 0	User-Defined	0x06
0x01	Computer-Generated Data, Format 1	Setup Record	0x09
0x02	Computer-Generated Data, Format 2	Recording Events	0x06
0x03	Computer-Generated Data, Format 3	Recording Index	0x06
0x04	Computer-Generated Data, Format 4	Streaming Configuration Records	0x08
0x05 – 0x07	Computer-Generated Data, Format 5-Format 7	Reserved for future use	0x06
0x08	PCM Data, Format 0	Reserved for future use	0x06
0x09	PCM Data, Format 1	Chapter 4, 7, or 8	0x06
0x0A	PCM Data, Format 2	DQE PCM	0x09
0x0B - 0x0F	PCM Data, Format 3 - Format 7	Reserved for future use	0x06
0x10	Time Data, Format 0	Reserved for future use	0x06
0x11	Time Data, Format 1	RCC/Global Positioning System (GPS)/Relative Time Counter (RTC)	0x06
0x12	Time Data, Format 2	Network Time	0x08

Table 11-4. Data Type Names and Descriptions

Packet Header Value	Data Type Name	Data Type Description	Current Data Type Version
0x13-0x17	Time Data, Format 2-Format 7	Reserved for future use	0x06
0x18	MIL-STD-1553 Data, Format 0	Reserved for future use	0x06
0x19	MIL-STD-1553 Data, Format 1	MIL-STD-1553B Data	0x06
0x1A	MIL-STD-1553 Data, Format 2	16PP194 Bus	0x06
0x1B-0x1F	MIL-STD-1553 Data, Format 3-Format 7	Reserved for future use	0x06
0x20	Analog Data, Format 0	Reserved for future use	0x06
0x21	Analog Data, Format 1	Analog Data	0x06
0x22-0x27	Analog Data, Format 2-Format 7	Reserved for future use	0x06
0x28	Discrete Data, Format 0	Reserved for future use	0x06
0x29	Discrete Data, Format 1	Discrete Data	0x06
0x2A-0x2F	Discrete Data, Format 2-Format 7	Reserved for future use	0x06
0x30	Message Data, Format 0	Generic Message Data	0x06
0x31-0x37	Message Data, Format 1-Format 7	Reserved for future use	0x06
0x38	ARINC-429 Data, Format 0	ARINC-429 Data	0x06
0x39- 0x3F	ARINC-429 Data, Format 1-Format 7	Reserved for future use	0x06
0x40	Video Data, Format 0	MPEG-2/H.264 Video	0x06
0x41	Video Data, Format 1	ISO 13818-1 MPEG-2	0x06
0x42	Video Data, Format 2	ISO 14496-10 MPEG-4 Part 10 AVC/ITU H.264	0x06
0x43	Video Data, Format 3	MJPEG	0x07
0x44	Video Data, Format 4	MJPEG-2000	0x07
0x45-0x47	Video Data, Format 3-Format 7	Reserved for future use	0x06
0x48	Image Data, Format 0	Image Data	0x06
0x49	Image Data, Format 1	Still Imagery	0x06
0x4A-	Image Data, Format 2	Dynamic Imagery	0x06
0x4B-0x4F	Image Data, Format 3-Format 7	Reserved for future use	0x06
0x50	UART Data, Format 0	UART Data	0x06
0x51-0x57	UART Data, Format 1-Format 7	Reserved for future use	0x06
0x58	IEEE 1394 Data, Format 0	IEEE 1394 Transaction	0x06
0x59	IEEE 1394 Data, Format 1	IEEE 1394 Physical Layer	0x06
0x5A-0x5F	IEEE 1394 Data, Format 2-Format 7	Reserved for future use	0x06
0x60	Parallel Data, Format 0	Parallel Data	0x06
0x61-0x67	Parallel Data, Format 1-Format 7	Reserved for future use	0x06
0x68	Ethernet Data, Format 0	Ethernet Data	0x07
0x69	Ethernet Data, Format 1	Ethernet UDP Payload	0x06
0x6A-0x6F	Ethernet Data, Format 2-Format 7	Reserved for future use	0x06
0x70	TSPI/CTS Data, Format 0	GPS NMEA-RTCM	0x06
0x71	TSPI/CTS Data, Format 1	EAG ACMI	0x06

Table 11-4. Data Type Names and Descriptions			
Packet Header Value	Data Type Name	Data Type Description	Current Data Type Version
0x72	TSPI/CTS Data, Format 2	ACTTS	0x06
0x73- 0x77	TSPI/CTS Data, Format 3-Format 7	Reserved for future use	0x06
0x78	Controller Area Network Bus	CAN Bus	0x06
0x79	Fibre Channel Data, Format 0	Fibre Channel Data	0x07
0x7A	Fibre Channel Data, Format 1	Fibre Channel Data	0x08
0x7B – 0x80	Fibre Channel Data, Formats 2-7	Reserved for future use	0x08

- f. Sequence Number. This byte contains a value representing the packet sequence number for each channel ID. This is simply a counter that increments by $n + 0x01$ to $0xFF$ for every packet transferred from a particular channel and is not required to start at $0x00$ for the first occurrence of a packet for the channel ID.

 <p>NOTE</p>	The sequence number counter value for each channel in a session (e.g., recording) will repeat (rollover to $0x00$) after the sequence number counter has reached $0xFF$.
------------------------------------------------------------------------------------------------------	----------------------------------------------------------------------------------------------------------------------------------------------------------------------------

 <p>NOTE</p>	Each channel in a session shall have its own sequence counter providing a unique sequence number for that channel.
-------------------------------------------------------------------------------------------------------	--------------------------------------------------------------------------------------------------------------------

- g. Packet Flags. This byte contains bits representing information on the content and format of the packet(s).

Bit 7: Indicates the presence or absence of the packet secondary header.

- 0 = Packet secondary header is not present.
- 1 = Packet secondary header is present.

Bit 6: Indicates the IPTS time source.

- 0 = Packet header 48-bit RTC.
- 1 = Packet secondary header time (bit 7 must be 1).

Bit 5: RTC sync error.

- 0 = No RTC sync error.
- 1 = RTC sync error has occurred.

Bit 4: Indicates the data overflow error.

- 0 = No data overflow.
- 1 = Data overflow has occurred.

Bits 3-2: Indicate the packet secondary header time format.

- 00 = Chapter 4 binary weighted 48-bit time format. The two lsbs of the 64-bit packet secondary header time and IPTS shall be zero-filled.
- 01 = IEEE 1588 time format. The packet secondary header time and each IPTS shall contain a 64-bit timestamp represented in accordance with (IAW) the time representation type as specified by IEEE STD 1588-2008.¹ The 32 bits indicating seconds shall be placed into the MSLW portion of the secondary header and the 32 bits indicating nanoseconds shall be placed into the LSLW portion.
- 10 = 64-bit binary extended relative time counter (ERTC) with 1-nanosecond resolution. The counter shall be derived from a free-running 1-gigahertz (GHz) clock - similar to the RTC described below - just with higher resolution. When this option is used, the 10-megahertz (MHz) RTC shall be synchronized with the ERTC (RTC = ERTC/100).
- 11 = Reserved

Bits 1-0: Indicate data checksum existence.

- 00 = No data checksum present
- 01 = 8-bit data checksum present
- 10 = 16-bit data checksum present
- 11 = 32-bit data checksum present

- h. Data Type. This byte contains a value representing the type and format of the data. All values not used to define a data type are reserved for future data type growth. [Table 11-4](#) lists the data types and their descriptions.
- i. Relative Time Counter. These 6 bytes contain a value representing the 10-MHz RTC. This is a free-running 10-MHz binary counter represented by 48 bits that are common to all data channels. The counter shall be derived from a 10-MHz internal crystal oscillator and shall remain free-running during each session (e.g., recording).

 NOTE	If enabled, the applicable data bit of the 48-bit value of the packet secondary time value shall correspond to the first bit of the data in the packet body (unless it is defined in each data type section).
-------------------------------------------------------------------------------------------------	---------------------------------------------------------------------------------------------------------------------------------------------------------------------------------------------------------------

- j. Header Checksum. These 2 bytes contain a value representing a 16-bit arithmetic sum of all 16-bit words in the header excluding the header checksum word.

11.2.1.2 Packet Secondary Header (Optional)

The length of the packet secondary header is fixed at 12 bytes (96 bits). The packet secondary header is optional and when enabled shall consist of the three fields, positioned contiguously, in the following sequence.

- a. Time. These 8 bytes contain the value representing time in the format indicated by bits 2 and 3 of the packet flags in Subsection [11.2.1.1](#) item [g](#). The secondary header can be

¹ Institute of Electrical and Electronics Engineers. *IEEE standard for a precision clock synchronization protocol for networked measurement and control systems*. IEEE 1588-2008. Geneva: International Electrotechnical Commission, 2008.

enabled on a channel-by-channel basis but all channels that have a secondary header must use the same time source in bits 2-3 of the packet flags.

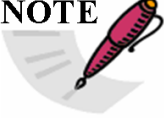
	<p>NOTE The applicable data bit to which the 48-bit value of the packet secondary time value (if enabled) applies shall correspond to the first bit of the data in the packet body (unless it is defined in each data type section).</p>
-----------------------------------------------------------------------------------	-------------------------------------------------------------------------------------------------------------------------------------------------------------------------------------------------------------------------------------------------

When Chapter 4 binary weighted time is used, time shall be stored as shown in [Figure 11-4](#).

msb	lsb
31	0
16 15	
Micro-Seconds Word	Reserved
High Order Time Word	Low Order Time Word

Figure 11-4. Secondary Header Chapter 4 Time

When IEEE 1588 time is used time shall be stored as shown in [Figure 11-5](#).

msb	lsb
31	0
Nanoseconds Word	
Seconds Word	

Figure 11-5. Secondary Header IEEE 1588 Time

When ERTC time is used time shall be stored as shown in [Figure 11-6](#).

msb	lsb
31	0
LSLW	
MSLW	

Figure 11-6. Secondary Header ERTC Time

- b. Reserved. These 2 bytes are reserved and shall be zero filled.
- c. Secondary Header Checksum. These 2 bytes contain a value representing a 16-bit arithmetic sum of all secondary header bytes excluding the secondary header checksum word.

11.2.1.3 Packet Body

The format of the data in the packet body is unique to each data type. Detailed descriptions of the type-specific data formats found in packet bodies are described in subsequent sections of this document.

- a. Channel-Specific Data. Variable in size, this contains the contents of the channel-specific data field(s) depending on the Data Type field in the packet header. Channel-specific data is mandatory for each data type and channel. The occurrence of channel-specific data is once per packet and precedes packet channel data.

- b. Intra-Packet Time Stamp. These 8 bytes contain time in either 48-bit RTC format (plus 16 high-order zero bits) or 64-bit format as specified in the packet flags in the packet header. The IPTSs are only mandatory where defined by the data formats.
- c. Intra-Packet Data Header. Variable in size, this contains additional time status, data, and/or format information pertaining to the data items that follow. The IPDHs are only mandatory where defined by the data formats.
- d. Data. With n bytes, this contains valid data from a particular channel as defined within the data formats contained within this standard.

	<p>NOTE The IPTS and the IPDH are collectively called the IPH. In some cases, an IPH may only have a timestamp (zero-length data header), while in other cases, the IPH only has a data header (zero-length timestamp). Some data types have no IPH. The IPH requirements are specified separately for each datatype.</p>
-----------------------------------------------------------------------------------	----------------------------------------------------------------------------------------------------------------------------------------------------------------------------------------------------------------------------------------------------------------------------------------------------------------------------------

	<p>NOTE The IPDH presence, once set, shall be the same state for the entire session (e.g., recording) per each channel</p>
-----------------------------------------------------------------------------------	-----------------------------------------------------------------------------------------------------------------------------------

11.2.1.4 Packet Trailer

The packet trailer may contain filler, a data checksum, both filler and a data checksum, or neither filler nor a data checksum. In the latter case, the packet trailer has zero length. The reason a packet trailer would have a zero length is best explained by understanding the reason for inserting filler. The purpose of the filler is twofold:

- a. To keep all packets aligned on 32-bit boundaries (i.e., make all packet lengths a multiple of 4 bytes); and
- b. To optionally keep all packets from a particular channel the same length.

If both of the above requirements are already met without adding filler, then filler shall not be added.

The inclusion of the data checksum is optional as well and is indicated by the packet flags setting. When included, the packet trailer contains either an 8-bit, 16-bit, or 32-bit data checksum. Depending on the packet flags option selected, the data checksum is the arithmetic sum of all of the bytes (8 bits), words (16 bits), or long words (32 bits) in the packet excluding the 24 bytes of packet header, packet secondary header (if enabled), and the data checksum. Stated another way, the data checksum includes everything in the packet body plus all added filler.

- a. Filler. Variable in size, all filler shall be set to 0x00 or 0xFF.
- b. 8-Bit Data Checksum. This 1 byte contains a value representing an 8-bit arithmetic sum of the bytes in the packet. It is only inserted if the packet flag bits are set (see Subsection [11.2.1.1](#) item g).
- c. 16-Bit Data Checksum. These 2 bytes contain a value representing a 16-bit arithmetic sum of the words in the packet. It is only inserted if the packet flag bits are set (Subsection [11.2.1.1](#) item g).

- d. 32-Bit Data Checksum. These 4 bytes contain a value representing a 32-bit arithmetic sum of the long words in the packet and is only inserted if packet flag bits are set (Subsection [11.2.1.1](#) item g).

11.2.2 PCM Data Packets

11.2.2.1 PCM Data Packets Format 0
Reserved.

11.2.2.2 PCM Data Packets Format 1 (Chapter 4 and Chapter 8)

A packet with Chapter 4 or Chapter 8 PCM data has the basic structure as shown in [Table 11-5](#). Note that the width of the structure is not related to any number of bits. This table merely represents relative placement of data in the packet.

Table 11-5. General PCM Data Packet, Format 1	
Packet Header	
Channel-Specific Data	
	(Optional) Intra-Packet Time Stamp
	(Optional) Intra-Packet Data Header
Minor Frame Data	
	(Optional) Intra-Packet Time Stamp
	(Optional) Intra-Packet Data Header
Minor Frame Data	
	(Optional) Intra-Packet Time Stamp
	(Optional) Intra-Packet Data Header
Minor Frame Data	
	(Optional) Intra-Packet Time Stamp
	(Optional) Intra-Packet Data Header
Minor Frame Data	
:	
	(Optional) Intra-Packet Time Stamp
	(Optional) Intra-Packet Data Header
Minor Frame Data	
Packet Trailer	

The user may separately enable or disable word unpacking on each active PCM channel. Word unpacking will force the lsb of each word to be aligned on a 16-bit boundary. High-order filler bits are added to words as necessary to force alignment.

The user may separately enable or disable frame synchronizing on each active PCM channel. This provides a throughput mode that will transfer data to the packet without frame synchronization. Throughput mode essentially disables all setup and packing/unpacking options for the packet, and places data in the packet as it is received.

- a. PCM Packet Channel-Specific Data. The packet body portion of each PCM packet begins with the channel-specific data, which is formatted as shown in [Figure 11-7](#).

msb										lsb
31	30	29	28	27	24	23	18	17		0
R	IPH	MA	MI	LOCKST	MODE					SYNCOFFSET

Figure 11-7. Pulse Code Modulation Packet Channel-Specific Data Format

- Reserved. Bit 31 is reserved.
- Intra-Packet Header. Bit 30 indicates if IPHs (IPTS and IPDH) are inserted before each minor frame. The IPHs are only optional because of the mode selection. This determines whether IPHs are included or omitted.
 - 0 = The IPHs are omitted for throughput mode.
 - 1 = The IPHs are required for packed data and unpacked data modes.
- Major Frame Indicator (MA). Bit 29 indicates if the first word in the packet is the beginning of a major frame. This bit is not applicable for throughput mode.
 - 0 = The first word is not the beginning of a major frame.
 - 1 = The first word is the beginning of a major frame.
- Minor Frame Indicator (MI). Bit 28 indicates if the first word in the packet is the beginning of a minor frame. This bit is not applicable for throughput mode.
 - 0 = The first word is not the beginning of a minor frame.
 - 1 = The first word is the beginning of a minor frame.
- Lock Status (LOCKST). Bits 27-24 indicate the lock status of the frame synchronizer. This bit is not applicable for throughput mode.

	<p>NOTE Minor Frame Definition. The minor frame is defined as the data structure in time sequence from the beginning of a minor frame synchronization pattern to the beginning of the next minor frame synchronization pattern. Please refer to Chapter 4, Subsection 4.3.2 for minor/major frame definition.</p>
-------------------------------------------------------------------------------------	------------------------------------------------------------------------------------------------------------------------------------------------------------------------------------------------------------------------------------------------------------------------------------------------------------------------------------------

Bits 27-26: Indicate minor frame status.

- 00 = Reserved.
- 01 = Reserved.
- 10 = Minor frame check (after losing lock).
- 11 = Minor frame lock.

Bits 25-24: Indicate major frame status.

- 00 = Major frame not locked.
- 01 = Reserved.
- 10 = Major frame check (after losing lock).
- 11 = Major frame lock.

- Mode (MODE). Bits 23-18 indicate the data packing mode.

Bits 23-22: Reserved.

Bit 21: Alignment Mode.

0 = 16-bit alignment mode enabled.

1 = 32-bit alignment mode enabled.

Bit 20: Indicates throughput data mode.

0 = Throughput data mode not enabled.

1 = Throughput data mode enabled.

Bit 19: Indicates packed data mode.

0 = Packed data mode not enabled.

1 = Packed data mode enabled.

Bit 18: Indicates unpacked data mode.

0 = Unpacked data mode not enabled.

1 = Unpacked data mode enabled.

- Sync Offset (SYNCOFFSET). Bits 17-0 contain an 18-bit binary value representing the word offset into the major frame for the first data word in the packet. The sync offset is not applicable for packed or throughput mode.
- b. PCM Packet Body. After the channel-specific data, the IPHs and the PCM data are inserted in the packet in integral numbers of minor or major frames unless the packet is in throughput mode. In throughput mode, there is no frame or word alignment to the packet data and no IPHs are inserted in the data. In both packed and unpacked modes, minor frame alignment is dependent on the MODE field in the channel-specific data. In 16-bit alignment mode, PCM minor frames begin and end on 16-bit boundaries. In 32-bit alignment mode, PCM minor frames begin and end on 32-bit boundaries. In either case, alignment mode does not affect the format of PCM data words themselves; however, depending on perspective, word order is affected and a zero-filled data word may be required to maintain alignment.
- c. PCM Data in Unpacked Mode. In unpacked mode, packing is disabled and each data word is padded with the number of filler bits necessary to align the first bit of each word with the next 16-bit boundary in the packet. For example, 4 pad bits are added to 12-bit words, 6 pad bits are added to 10-bit words, etc. In 32-bit alignment mode, a zero-filled 16-bit word is required to maintain alignment when an odd number of 16-bit words exists in the minor frame.

Minor frame sync patterns larger than 16 bits are divided into two words of packet data. If the sync pattern has an even number of bits, then it will be divided in half and placed in two packet words. For example, a 24-bit sync pattern is broken into two 12-bit words with 4 bits of pad in each word. If the sync pattern has an odd number of bits, it is broken into two words with the second word having one bit more of the sync pattern. For example, if the minor sync pattern is 25 bits, then the first sync word is 12 bits of sync pattern plus 4 bits of pad, and the second sync word is 13 bits of sync pattern plus 3 bits of pad.

Minor frame sync patterns larger than 32 bits are divided into $(\text{number of bits}+15)/16$ words in 16-bit alignment mode or $(\text{number of bits}+31)/32$ in 32-bit alignment mode. If the sync word doesn't fill the words completely, the first word shall contain the lesser number of bits with the later words containing one bit more (in the manner described

above in splitting frame sync pattern words into two words). For example, a 35-bit sync word shall be split into 11+12+12-bit words in 16-bit alignment mode, or into 17+18-bit words in 32-bit alignment mode.

Given PCM frames with a 24-bit minor sync pattern and n data words where the bit-lengths of data words 1, 2, and 3 are 12, 16, and 8 respectively, the resultant 16-bit alignment mode PCM packets are as shown in [Table 11-6](#). Given PCM frames with a 24-bit minor sync pattern and n data words where the bit-lengths of data words 1, 2, 3, and 4 are 12, 16, 8, and 10 respectively, the resultant 32-bit alignment mode PCM packets are as shown in [Table 11-7](#).

Table 11-6. PCM Data-Unpacked (16-Bit Alignment Mode) Sample Packet	
msb	lsb
15	0
Packet Header	
Channel-Specific Data (Bits 15-0)	
Channel-Specific Data (Bits 31-16)	
Intra-Packet Time Stamp (Bits 15-0)	
Intra-Packet Time Stamp (Bits 31-16)	
Intra-Packet Time Stamp (Bits 47-32)	
Intra-Packet Time Stamp (Bits 63-48)	
Intra-Packet Data Header (Bits 15-0)	
4 Bits Pad	12 Bits Sync (Bits 23-12)
4 Bits Pad	12 Bits Sync (Bits 11-0)
4 Bits Pad	12 Bits Word 1 Data
16 Bits Word 2 Data	
8 Bits Pad	8Bits Word 3 Data
:	
Word N Data Bits + Pad if Needed	
Intra-Packet Time Stamp (Bits 15-0)	
Intra-Packet Time Stamp (Bits 31-16)	
Intra-Packet Time Stamp (Bits 47-32)	
Intra-Packet Time Stamp (Bits 63-48)	
Intra-Packet Data Header (Bits 15-0)	
:	
Repeat for each minor frame.	
:	
Packet Trailer	

Table 11-7. PCM Data-Unpacked (32-Bit Alignment Mode) Sample Packet	
msb	lsb
15	0

Packet Header	
Channel-Specific Data (Bits 15-0)	
Channel-Specific Data (Bits 31-16)	
Intra-Packet Time Stamp (Bits 15-0)	
Intra-Packet Time Stamp (Bits 31-16)	
Intra-Packet Time Stamp (Bits 47-32)	
Intra-Packet Time Stamp (Bits 63-48)	
Intra-Packet Data Header (Bits 15-0)	
Intra-Packet Data Header (Bits 31-16)	
4 Bits Pad	12 Bits Sync (Bits 11-0)
4 Bits Pad	12 Bits Sync (Bits 23-12)
16 Bits Word 2 Data	
4 Bits Pad	12 Bits Word 1 Data
6 Bits Pad	10 Bits Word 4 Data
8 Bits Pad	8 Bits Word 3 Data
:	
Word N Data Bits + Pad If Needed	
Intra-Packet Time Stamp (Bits 15-0)	
Intra-Packet Time Stamp (Bits 31-16)	
Intra-Packet Time Stamp (Bits 47-32)	
Intra-Packet Time Stamp (Bits 63-48)	
Intra-Packet Data Header (Bits 15-0)	
Intra-Packet Data Header (Bits 31-16)	
:	
Repeat for each minor frame.	
:	
Packet Trailer	

- d. **PCM Data in Packed Mode.** In packed mode, packing is enabled and pad is not added to each data word; however, filler bits may be required to maintain minor frame alignment. The number of filler bits is dependent on the alignment mode, where N is either 16 or 32. If the number of bits in the minor frame is not an integer multiple of N, then Y pad bits will be added to the end of each minor frame of bit length L. Either $Y = N - \text{MOD}(L, N)$, or N minus the integer remainder when L is divided by N. In packed mode, the PCM stream is minor-frame synchronized so the first data bit in the packet is the first data bit of a minor frame. If $X = N - Y$ when N is 16-bit alignment mode, then the resultant PCM packets are as shown in [Table 11-8](#). [Table 11-9](#) shows the resultant PCM packets for 32-bit alignment mode.

Table 11-8. PCM Data-Packed (16-Bit Alignment Mode) Sample Packet	
msb	lsb
15	0
Packet Header	

Channel-Specific Data (Bits 15-0)	
Channel-Specific Data (Bits 31-16)	
Intra-Packet Time Stamp (Bits 15-0)	
Intra-Packet Time Stamp (Bits 31-16)	
Intra-Packet Time Stamp (Bits 47-32)	
Intra-Packet Time Stamp (Bits 63-48)	
Intra-Packet Data Header (Bits 15-0)	
Data (Bits 15-0)	
Data (Bits 31-16)	
Data (Bits 47-32)	
:	
Y Filler Bits	X Data Bits
Intra-Packet Time Stamp (Bits 15-0)	
Intra-Packet Time Stamp (Bits 31-16)	
Intra-Packet Time Stamp (Bits 47-32)	
Intra-Packet Time Stamp (Bits 63-48)	
Intra-Packet Data Header (Bits 15-0)	
:	
Repeat for each minor frame.	
:	
Packet Trailer	

Table 11-9. PCM Data-Packed (32-Bit Alignment Mode) Sample Packet	
msb	lsb
15	0
Packet Header	
Channel-Specific Data (Bits 15-0)	
Channel-Specific Data (Bits 31-16)	
Intra-Packet Time Stamp (Bits 15-0)	
Intra-Packet Time Stamp (Bits 31-16)	
Intra-Packet Time Stamp (Bits 47-32)	
Intra-Packet Time Stamp (Bits 63-48)	
Intra-Packet Data Header (Bits 15-0)	
Intra-Packet Data Header (Bits 31-16)	
Data Word 2	
Data Word 1	
Data Word 4	
Data Word 3	
:	
Filler Bits	X Data Bits
16 Filler Bits (If Required to Maintain 32-Bit Alignment)	
Intra-Packet Time Stamp (Bits 15-0)	

Intra-Packet Time Stamp (Bits 31-16)
Intra-Packet Time Stamp (Bits 47-32)
Intra-Packet Time Stamp (Bits 63-48)
Intra-Packet Data Header (Bits 15-0)
Intra-Packet Data Header (Bits 31-16)
:
Repeat for each minor frame.
:
Packet Trailer

- e. PCM Data in Throughput Mode. In throughput mode, the PCM data are not frame synchronized so the first data bit in the packet can be any bit in the major frame. The resultant PCM packets are as shown in [Table 11-10](#) and [Table 11-11](#).

Table 11-10. PCM Data-Throughput (16-Bit Alignment Mode) Sample Packet	
msb	lsb
15	0
Packet Header	
Channel-Specific Data (Bits 15-0)	
Channel-Specific Data (Bits 31-16)	
Data (Bits 15-0)	
Data (Bits 31-16)	
Data (Bits 47-32)	
:	
Packet Trailer	

Table 11-11. PCM Data-Throughput (32-Bit Alignment Mode) Sample Packet	
msb	lsb
15	0
Packet Header	
Channel-Specific Data (Bits 15-0)	
Channel-Specific Data (Bits 31-16)	
PCM Stream Bits 17-32	
PCM Stream Bits 1-16	
PCM Stream Bits 49-64	
PCM Stream Bits 33-48	
:	
Packet Trailer	

- f. PCM Data Word Order in 32-Bit Alignment Mode. When acquitting data in 32-bit alignment mode, the resultant data word ordering will differ from 16-bit alignment mode.

The serial PCM data stream is shifted into 32-bit words from right to left, with bit 31 on the left, bit 0 on the right, and addresses ascending from top to bottom. Word order is affected depending on the reader's addressing perspective. For example, 16-bit data words when addressed as 32-bit words appear in order when read from left to right and top to bottom; however, when addressed as 16-bit words, each pair of data words will appear swapped. [Figure 11-8](#) and [Figure 11-9](#) depict the anomaly of perspective.

msb			lsb		Address
31			0		
16		15			
Byte 3	Byte 2	Byte 1	Byte 0		
Data Word 1		Data Word 2		0	
Data Word 3		Data Word 4		1	
:					
Data Word N-1		Data Word N		(N/2)-1	

Figure 11-8. 32-Bit Alignment Mode Example, 16-Bit Data Words (32-Bit Word Addressing)

msb		lsb		Address
15		0		
Byte 1	Byte 0			
Data Word 2				0
Data Word 1				1
Data Word 4				2
Data Word 3				3
:				:
Data Word N-1				N-1

Figure 11-9. 32-Bit Alignment Mode Example, 16-Bit Data Words (16-Bit Word Addressing)

- g. PCM Intra-Packet Header. When acquiring data in packed or unpacked mode, all PCM minor frames shall include an IPH containing a 64-bit IPTS and a 16- or 32-bit IPDH, as indicated by MODE in the channel-specific data. This header is inserted immediately before the minor frame sync pattern. Depending on alignment mode, the length of the IPH is either 10 or 12 bytes (80 or 96 bits) positioned contiguously, as depicted in [Figure 11-10](#). In 16-bit alignment mode, the IPDH length is fixed at 2 bytes. A 32-bit alignment mode requires a 4-byte IPDH, and the two most significant bytes are zero-filled.

msb			lsb	
31			0	
16		15		12 11
Time (LSLW)				
Time (MSLW)				
Zero Filled		LOCKST		RESERVED

Figure 11-10. Pulse Code Modulation Intra-Packet Header

- Intra-Packet Time Stamp. These 8 bytes indicate the time tag of the PCM minor frame. This time stamp is not applicable for throughput mode. First long word bits and second long word bits indicate the following values:

- The 48-bit RTC that corresponds to the first data bit of the minor frame with bits 31 to 16 in the second long word zero-filled; or
- Absolute time, if enabled by bit 6 in the packet flags (Subsection [11.2.1.1](#) item [g](#)). The time format is indicated by bits 2 and 3 in the packet flags (Subsection [11.2.1.1](#) item [g](#)). The time tag shall be correlated to the first data bit of the minor frame.
- Intra-Packet Data Header
 - 32-Bit Alignment (32-Bit Alignment mode ONLY). Bits 31-16 are zero-filled.
 - Lock Status (LOCKST). Bits 15-12 indicate the lock status of the frame synchronizer for each minor frame.
 - Bits 15-14: Indicates minor frame status.
 - 00 = Reserved
 - 01 = Reserved
 - 10 = Minor frame check (after losing lock)
 - 11 = Minor frame lock
 - Bits 13-12: Indicates major frame status.
 - 00 = Major frame not locked
 - 01 = Reserved
 - 10 = Major frame check (after losing lock)
 - 11 = Major frame lock
 - Reserved. Bits 11-0 are reserved.

11.2.2.3 PCM Data Packets Format 2 (DQE)

A PCM Data Packet, Format 2 provides a known method of capturing throughput PCM (Chapter 4, 7, or 8) with inserted Data Quality Encapsulation (DQE). The basic structure as shown in [Table 11-12](#). Note that the width of the structure is not related to any number of bits. This table merely represents relative placement of data in the packet.

Table 11-12. General PCM Data Packet, Format 2
Packet Header
Channel-Specific Data Word
DQE Header
DQM PCM Payload
DQE Header
DQM PCM Payload
:
DQE Header
DQM PCM Payload
Packet Trailer

The telemetry receiver/demodulator determines and inserts the DQE protocol IAW [Chapter 2](#), Appendix 2-G.

Channel-Specific Data (Bits 31-16)
Data (Bits 15-0)
Data (Bits 31-16)
Data (Bits 47-32)
:
Packet Trailer

Table 11-14. PCM Data-Throughput (32-Bit Alignment Mode) Sample Packet, Format 2	
msb	lsb
15	0
Packet Header	
Channel-Specific Data (Bits 15-0)	
Channel-Specific Data (Bits 31-16)	
PCM Stream Bits 17-32	
PCM Stream Bits 1-16	
PCM Stream Bits 49-64	
PCM Stream Bits 33-48	
:	
Packet Trailer	

11.2.3 Time Data Packets

11.2.3.1 Time Data Packets, Format 0. Reserved.

11.2.3.2 Time Data Packets, Format 1 (IRIG/GPS/RTC)

Time is treated like another data channel. If a time source other than NONE is used (Figure 11-12), the time packet will be generated at a minimum frequency of 1 hertz.

msb										lsb
31		16	15	12	11	8	7	4	3	0
Reserved			ITS		DATE		FMT		SRC	

Figure 11-12. Time Packet Channel-Specific Data Format

- Inter-Range Instrumentation Group (IRIG) Time Type Formats. The 10-MHz RTC shall be captured for insertion into the time packet data header IAW IRIG 200.²
- All Non-IRIG Time Type Formats. The 10-MHz RTC shall be captured for insertion into the time packet data header consistent with the resolution with the time packet body format (10 milliseconds [ms] as measured by the 10-MHz RTC).

² Range Commanders Council. *IRIG Serial Time Code Formats*. RCC 200-16. August 2016. May be superseded by update. Retrieved 6 July 2020. Available at <https://www.trmc.osd.mil/wiki/x/wou8Bg>.

 <p>NOTE</p>	<p>A time data packet shall be the first dynamic data packet at the start of each session. Only static Computer-Generated Data, Format 1 packets may precede the first time data packet.</p>
------------------------------------------------------------------------------------------------------	----------------------------------------------------------------------------------------------------------------------------------------------------------------------------------------------

 <p>NOTE</p>	<p>If the time data packet source is None, at least one time data packet is required IAW the previous note.</p>
------------------------------------------------------------------------------------------------------	-----------------------------------------------------------------------------------------------------------------

A packet with time data has the basic structure shown in [Table 11-15](#). Note that the width of the structure is not related to any number of bits. This drawing is merely to represent relative placement of data in the packet. Time packets do not have IPHs.

Table 11-15. General Time Data Packet, Format 1
Packet Header
Channel-Specific Data
Time Data
Packet Trailer

- a. Time Packet Channel-Specific Data. The packet body portion of each time data packet begins with a CSDW formatted as shown in [Figure 11-12](#).
 - Reserved. Bits 31-16 are reserved.
 - IRIG Time Source (ITS). Bits 15-12 provide dynamic information regarding the source of time for an internal IRIG time code generator (TCG) when FMT is IRIG-A, B, or G. The ITS bits can toggle depending upon quality/validity of sources.
 - 0000 = IRIG TCG freewheeling (no or loss of time source)
 - 0001 = IRIG TCG freewheeling from .TIME command
 - 0010 = IRIG TCG freewheeling from RMM time
 - 0011 = IRIG TCG locked to external IRIG time signal
 - 0100 = IRIG TCG locked to external GPS
 - 0101 = IRIG TCG locked to external Network Time Protocol (NTP)
 - 0110 = IRIG TCG locked to external Precision Time Protocol (PTP)
 - 0111 = IRIG TCG locked to external embedded time from input track/channel such as PCM or MIL-STD-1553
 - 1000-1111 = Reserved
 - Date (DATE). Bits 11-8 indicate the date format. All bit patterns not used to define a date format type are reserved for future growth.
 - Bits 11-10: Reserved.
 - Bit 9: Indicates date format.
 - 0 = IRIG day available ([Figure 11-13](#))
 - 1 = Month and year available ([Figure 11-14](#))

msb										lsb																																																																																																																												
15															14															12															11															8															7															4															3															0														
0															TSn															Sn															Hmn															Tmn																																																																										
0															0															THn															Hn															0															TMn															Mn																																												
0															0															0															0															0															0															HDn															TDn															Dn														

Figure 11-13. Time Data-Packet Format, Day Format

msb										lsb																																																																																																																												
15															14															12															11															8															7															4															3															0														
0															TSn															Sn															Hmn															Tmn																																																																										
0															0															THn															Hn															0															TMn															Mn																																												
0															0															0															Ton															On															TDn															Dn																																												
0															0															OYn															HYn															TYn															Yn																																																											

Figure 11-14. Time Data-Packet Format, Day, Month, and Year Format

- Bit 8: Indicates if this is a leap year.

0 = Not a leap year

1 = Is a leap year

- Time Format (FMT). Bits 7-4 indicate the time data packet format.
 - 0x0 = IRIG-B
 - 0x1 = IRIG-A
 - 0x2 = IRIG-G
 - 0x3 = Real-Time Clock
 - 0x4 = Universal Coordinated Time (UTC) time from GPS
 - 0x5 = Native GPS Time
 - 0x6 – 0xE = Reserved
 - 0xF = NONE (time packet payload invalid)
- Time Source (SRC). Bits 3-0 indicate the source of the time in the payload of each time packet.
 - 0x0 = Internal (time derived from a clock in the recorder)
 - 0x1 = External (time derived from a clock not in the recorder)
 - 0x2 = Internal from RMM (time derived from the clock in the RMM)
 - 0x3 – 0xE = Reserved
 - 0xF = None

 <p>NOTE</p>	<p>If the time source is external (0x1) and lock on the external source is lost then the time source shall indicate Internal (0x0). Once lock on the external time source is regained, time source shall once again indicate external (0x1).</p>
--------------------------------------------------------------------------------------------------------	--------------------------------------------------------------------------------------------------------------------------------------------------------------------------------------------------------------------------------------------------

- b. Time Packet Body. After the CSDW, the time data words are inserted in the packet in binary-coded decimal format as shown in [Figure 11-13](#) and [Figure 11-14](#) (units of measure presented in [Table 11-16](#)).

Table 11-16. Units of Measure			
Tmn	Tens of ms	TDn	Tens of days
Hmn	Hundreds of ms	HDn	Hundreds of days
Sn	Units of seconds	On	Units of months
TSn	Tens of Seconds	TOn	Tens of months
Mn	Units of minutes	Yn	Units of years
TMn	Tens of minutes	TYn	Tens of years
Hn	Units of hours	HYn	Hundreds of years
THn	Tens of hours	OYn	Thousands of years
Dn	Units of days	0	Always zero

11.2.3.3 Time Data Packets, Format 2 (Network Time)

The Format 2 Network Time packet data type is used to extract and encapsulate absolute time from NTP or IEEE-1588 PTP and time tag it with the RTC. The Format 2 Network Time packet will be generated at a minimum frequency of 1 hertz unless it is recorded at the raw network rate of the NTP or PTP frames.

The NTP is referenced in UTC time with an epoch of January 1, 1900. The NTP time includes leap seconds.

The PTP is referenced in International Atomic Time with an epoch of January 1, 1970. The PTP time does not include leap seconds.

	<p>NOTE A time data packet shall be the first dynamic data packet at the start of each recording. Only static Computer-Generated Data, Format 1 packets may precede the first time data packet in the recording.</p>
-------------------------------------------------------------------------------------	-----------------------------------------------------------------------------------------------------------------------------------------------------------------------------------------------------------------------------

The Format 2 Network Time packet has the basic structure shown in [Table 11-17](#). Note that the width of the structure is not related to any number of bits. This drawing is merely to represent relative placement of data in the packet. Format 2 Network Time packets do not have IPHs.

Table 11-17. General Time Data Packet, Format 1
Packet Header
Channel-Specific Data
Time Data
Packet Trailer

- a. Time Packet Channel-Specific Data. The packet body portion of each time data packet begins with a CSDW formatted as shown in [Figure 11-15](#).

b. msb					lsb
31	8	7	4	3	0
Reserved			NTF	TS	

Figure 11-15. Format 2 Network Time Packet Channel-Specific Data Format

- Reserved. Bits 31-8 are reserved.
 - Network Time Format (NTF). Bits 7-4 indicate the time data packet format.
 - 0x0 = Network Time Protocol Version 3 (Request for Comment 1305³).
 - 0x1 = IEEE-1588-2002
 - 0x2 = IEEE-1588-2008
 - 0x3 – 0xF = Reserved
 - Time Status (TS). Bits 3-0 indicate the status of the network time.
 - 0x0 = Time Not Valid
 - 0x1 = Time Valid
 - 0x2 – 0xF = Reserved
- c. Time Packet Body. After the CSDW, the time data is inserted in the packet as shown in [Figure 11-16](#) for NTP and [Figure 11-17](#) for PTP.

msb	lsb
31	0
Time Unsigned Seconds	
Time Unsigned Seconds Fractions	

Figure 11-16. Format 2 Network Time Packet NTP Time Data

msb	lsb
31	0
Time Unsigned Seconds	
Time Unsigned Nanoseconds	

Figure 11-17. Format 2 Network Time Packet PTP Time Data

11.2.4 MIL-STD-1553 Packets

11.2.4.1 MIL-STD-1553 Bus Data Packets, Format 0. Reserved.

11.2.4.2 MIL-STD-1553 Bus Data Packets, Format 1 (MIL-STD-1553B Bus Data)

Data in the MIL-STD-1553 bus format is packetized as messages, with each 1553 bus transaction recorded as a message. A transaction is a bus controller (BC)-to-remote terminal (RT), RT-to-BC, or RT-to-RT word sequence, starting with the command word and including all

³ Internet Engineering Task Force. “Network Time Protocol (Version 3) Specification, Implementation and Analysis.” RFC 1305. March 1992. Obsolete by RFC 5905. Retrieved 6 July 2020. Available at <https://datatracker.ietf.org/doc/rfc1305/>.

data and status words that are part of the transaction, or a mode code word broadcast. Multiple messages may be encoded into the data portion of a single packet.

- a. MIL-STD-1553 Packet Channel-Specific Data. The packet body portion of each MIL-STD-1553 data packet begins with a CSDW formatted as shown in [Figure 11-18](#).

msb	lsb
31 30 29 24 23	0
TTB	RESERVED
MSGCOUNT	

Figure 11-18. MIL-STD-1553 Packet Channel-Specific Data Format

- Time Tag Bits (TTB). Bits 31-30 indicate which bit of the MIL-STD-1553 message the IPH time tags.
 - 00 = Last bit of the last word of the message
 - 01 = First bit of the first word of the message
 - 10 = Last bit of the first (command) word of the message
 - 11 = Reserved
 - Reserved. Bits 29-24 are reserved.
 - Message Count (MSGCOUNT). Bits 23-0 indicate the binary value of the number of messages included in the packet. An integral number of complete messages will be in each packet.
- b. MIL-STD-1553 Packet Body. A packet within MIL-STD-1553 messages has the basic structure shown in [Table 11-18](#). Note that the width of the structure is not related to any number of bits. This drawing is merely intended to represent relative placement of data in the packet.

Table 11-18. MIL-STD-1553 Data Packet, Format 1 Basic Layout	
Packet Header	
Channel-Specific Data	
	Intra-Packet Time Stamp for Message 1
	Intra-Packet Data Header for Message 1
Message 1	
	Intra-Packet Time Stamp for Message 2
	Intra-Packet Data Header for Message 2
Message 2	
:	
	Intra-Packet Time Stamp for Message N
	Intra-Packet Data Header for Message N
Message N	
Packet Trailer	

c. MIL-STD-1553 Intra-Packet Header. After the channel-specific data, the MIL-STD-1553 data are inserted into the packet in messages. Each MIL-STD-1553 message is preceded by an IPH consisting of an IPTS and an IPDH.

- (1) MIL-STD-1553 Intra-Packet Time Stamp. These 8 bytes indicate the time tag of the MIL-STD-1553 message as follows.
 - The 48-bit RTC that corresponds to the data bit indicated in the MIL-STD-1553 channel-specific data, TTBs (Subsection [11.2.4.2](#) item [a](#)) with bits 31 to 16 in the second long word zero-filled; or
 - The absolute time, if enabled by bit 6 in the packet flags (Subsection [11.2.1.1](#) item [g](#)). The time format is indicated by bits 2 and 3 in the packet flags (Subsection [11.2.1.1](#) item [g](#)). The time tag shall be correlated to the data bit indicated in the MIL-STD-1553 channel-specific data, TTBs (Subsection [11.2.4.2](#) item [a](#)).
- (2) MIL-STD-1553 Intra-Packet Data Header. The length of the IPDH is fixed at 6 bytes (48 bits) positioned contiguously, in the following sequence ([Figure 11-19](#)).

msb	lsb
15	0
Block Status Word	
Gap Times Word	
Length Word	

Figure 11-19. MIL-STD-1553 Intra-Packet Data Header

- Block Status Word (BSW). Bits 15-0 contain the block status word for both the message type and any 1553 bus protocol errors that occurred during the message transfer. The block status word bit definitions are in [Figure 11-20](#).

msb																lsb
15	14	13	12	11	10	9	8		6	5	4	3	2			0
R		BID	ME	RR	FE	TM	RESERVED		LE	SE	WE	RESERVED				

Figure 11-20. Block Status Word

- Reserved (R). Bits 15-14 are reserved.
- Bus ID (BID). Bit 13 indicates the bus ID for the message.
 - 0 = Message was from channel A
 - 1 = Message was from channel B
- Message Error (ME). Bit 12 indicates a message error was encountered.
 - 0 = No message error
 - 1 = Message error
- RT to RT Transfer (RR). Bit 11 indicates a, RT to RT transfer; message begins with two command words.
 - 0 = No RT to RT transfer

1 = RT to RT transfer

- Format Error (FE). Bit 10 indicates any illegal gap on the bus other than response timeout.

0 = No format error

1 = Format error

- Response Time Out (TM). Bit 9 indicates a response time out occurred. The bit is set if any of the status word(s) belonging to this message didn't arrive within the response time of 14 microseconds (μs) defined by MIL-STD-1553B.⁴

0 = No response time out

1 = Response time out

- Reserved. Bits 8-6 are reserved.
- Word Count Error (LE). Bit 5 indicates that the number of data words transmitted is different than identified in the command word. A MIL-STD-1553B status word with the busy bit set to true will not cause a word count error. A transmit command with a response timeout will not cause a word count error.

0 = No word count error

1 = Word count error

- Sync Type Error (SE). Bit 4 indicates an incorrect sync type occurred.

0 = No sync type error

1 = Sync type error

- Invalid Word Error (WE). Bit 3 indicates an invalid word error occurred. This includes Manchester decoding errors in the sync pattern or word bits, invalid number of bits in the word, or parity error.

0 = No invalid word error

1 = Invalid word error

- Reserved. Bits 2-0 are reserved.

NOTE



Gap Times (response time): The gap times word indicates RT response times as defined by MIL-STD-1553. The resolution of the response time shall be in tenths of μs . A maximum of two response time words can exist. Messages of RT-to-RT type shall have two response time words if both terminals respond; all other messages will have one response time word, or none for broadcast type messages or messages with no RT response.

- Gap Times Word. Bits 15-0 indicate the number of tenths of μs in length of the internal gaps within a single transaction. For most messages, only GAP1 is

⁴ Department of Defense. "Aircraft Internal Time Division Command/Response Multiplex Data Bus." MIL-STD-1553B. 21 September 1978. Superseded by update 28 February 2018. Retrieved 6 July 2020. Available at https://quicksearch.dla.mil/qsDocDetails.aspx?ident_number=36973.

meaningful. It measures the time between the command or data word and the first (and only) status word in the message. For RT-to-RT messages, GAP2 measures the time between the last data word and the second status word. The gap times word bit definitions are as shown in [Figure 11-21](#).

msb		lsb
15	8 7	0
GAP2		GAP1

Figure 11-21. Gap Times Word

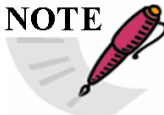
 NOTE	Gap measurements shall be made IAW MIL-STD-1553 response time measurements from the mid-bit zero crossing of the parity bit of the last word to the mid-zero crossing of the sync of the status word.
-----------------------------------------------------------------------------------------------	-------------------------------------------------------------------------------------------------------------------------------------------------------------------------------------------------------

- Length Word. Bits 15-0 contain the length of the message, which is the total number of bytes in the message. A message consists of command words, data words, and status words.
- d. Packet Format. Unless an error occurred, as indicated by one of the error flags in the block status word, the first word following the length word shall always be a command word. The resultant packets have the format shown in [Table 11-19](#).

Table 11-19. MIL-STD-1553 Data Packet, Format 1	
msb	lsb
15	0
Packet Header	
Channel-Specific Data (Bits 15-0)	
Channel-Specific Data (Bits 31-16)	
Intra-Packet Time Stamp for Msg 1 (Bits 15-0)	
Intra-Packet Time Stamp for Msg 1 (Bits 31-16)	
Intra-Packet Time Stamp for Msg 1 (Bits 47-32)	
Intra-Packet Time Stamp for Msg 1 (Bits 63-48)	
Intra-Packet Data Header for Msg 1 (Bits 15-0)	
Intra-Packet Data Header for Msg 1 (Bits 31-16)	
Intra-Packet Data Header for Msg 1 (Bits 47-32)	
Command Word	
Command, Status, or Data Word	
Data or Status Word	
:	
Data or Status Word	
Intra-Packet Time Stamp for Msg 2 (Bits 15-0)	
Intra-Packet Time Stamp for Msg 2 (Bits 31-16)	
Intra-Packet Time Stamp for Msg 2 (Bits 47-32)	
Intra-Packet Time Stamp for Msg 2 (Bits 63-48)	
Intra-Packet Data Header for Msg 2 (Bits 15-0)	

Intra-Packet Data Header for Msg 2 (Bits 31-16)
Intra-Packet Data Header for Msg 2 (Bits 47-32)
Command Word
Command, Status, or Data Word
Data or Status Word
:
Data or Status Word
:
Intra-Packet Time Stamp for Msg N (Bits 15-0)
Intra-Packet Time Stamp for Msg N (Bits 31-16)
Intra-Packet Time Stamp for Msg N (Bits 47-32)
Intra-Packet Time Stamp for Msg N (Bits 63-48)
Intra-Packet Data Header for Msg N (Bits 15-0)
Intra-Packet Data Header for Msg N (Bits 31-16)
Intra-Packet Data Header for Msg N (Bits 47-32)
Command Word
Command or Data Word
Data or Status Word
:
Data or Status Word
Packet Trailer

11.2.4.3 MIL-STD-1553 Bus Data Packets, Format 2 (Bus 16PP194 Weapons Bus Data)

This data type provides packetization for the F-16 MIL-STD-1553 weapons multiplex bus as defined in document 16PP362B.⁵ A 16PP194 transaction consists of six each 32-bit words consisting of a 16PP194 COMMAND (1), COMMAND (1) ECHO, COMMAND (2), COMMAND (3) GO/NOGO, COMMAND (4) GO/NOGO, and STATUS as illustrated in [Figure 11-22](#). Multiple transactions may be encoded into the data portion of a single packet.

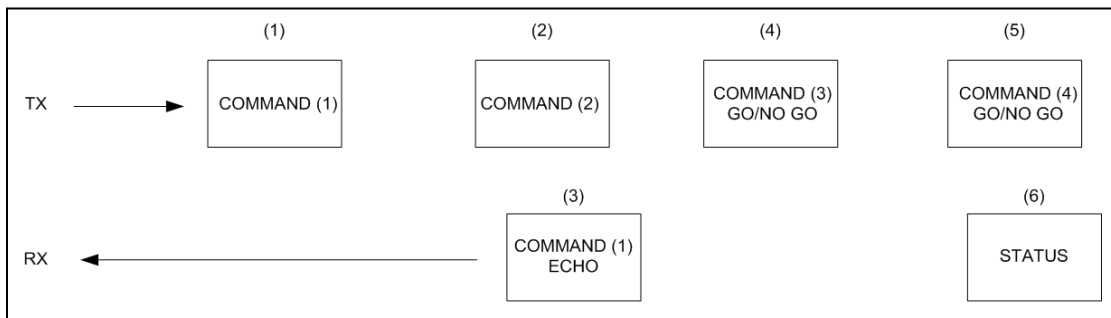

Figure 11-22. 16PP194 Message Transaction

- a. MIL-STD-1553 16PP194 Packet Channel-Specific Data Word. The packet body portion of each 16PP MIL-STD-1553 data packet begins with a CSDW formatted as shown in

⁵ Lockheed Martin Corporation. “Advanced Weapons Multiplex Data Bus.” 8 June 2010. May be superseded by update. Retrieved 6 July 2020. Available to RCC members with Private Portal access at https://wsdmext.wsmr.army.mil/site/rccpri/Limited_Distribution_References/16PP362B.pdf.

[Figure 11-23](#). Bits 31-0 indicate the binary value of the number of messages included in the packet. An integral number of complete transaction messages will be in each packet.

msb	lsb
31	0
MSGCOUNT	

Figure 11-23. Military Standard 1553 16PP194 Packet Channel-Specific Data Format

- b. MIL-STD-1553 16PP194 Packet Body. A packet with n MIL-STD-1553 16PP194 transactions has the basic structure shown in [Table 11-20](#) below. This drawing is merely to represent relative placement of data in the packet.

Table 11-20. MIL-STD-1553 16PP194 Data Packet Basic Layout	
msb	lsb
31	0
Packet Header	
16PP194 Channel-Specific Data Word	
Intra-Packet Time Stamp (LSLW)	
Intra-Packet Time Stamp (MSLW)	
Intra-Packet Data Header Length Word	Intra-Packet Data Header Status Word
Data 1	
.	
.	
Intra-Packet Time Stamp (LSLW)	
Intra-Packet Time Stamp (MSLW)	
Intra-Packet Data Header Length Word	Intra-Packet Data Header Status Word
Data N	
.	
.	
PACKET TRAILER	

- c. MIL-STD-1553 16PP194 Intra-Packet Header. The IPH consists of the IPDH (LENGTH and STATUS) and the IPTS.
- MIL-STD-1553 16PP194 Intra-Packet Data Header LENGTH. The length word contains the length in bytes of the intra-packet data.

 <p>NOTE</p>	<p>The intra-packet length is fixed to 0x18, 24 bytes.</p>
--------------------------------------------------------------------------------------------------------	------------------------------------------------------------

- MIL-STD-1553 16PP194 Intra-Packet Data Header STATUS. The status word contains error and special handling information about the data. When set to a “1”, the error indicator bits reflect that such an error is present in the data or occurred during data reception. The format of the status word is shown in [Figure 11-24](#).

msb										lsb	
15	14	13	12		7	6	5	4	3	2	0
TE	RE	TM	RESERVED			SE	R	EE	RESERVED		

Figure 11-24. Military Standard 1553 16PP194 Intra-Packet Data Header Format

- Transaction Error (TE). Bit 15 indicates an error condition found in 16PP194 transaction.
 - 0 = No errors found in current transaction
 - 1 = Error condition found in transaction
 - Reset (RE). Bit 14 indicates a 16PP194 bus master reset.
 - 0 = No master reset
 - 1 = Master reset assertion detected
 - Message Time Out (TM). Bit 13 indicates a transaction time out occurred.
 - 0 = No message time out
 - 1 = Message time out
 - Reserved. Bits 12-7 are reserved.
 - Status Error (SE). Bit 6 indicates status word missing in transaction.
 - 0 = Status word present
 - 1 = Status word missing
 - Reserved (R). Bits 5-4 are reserved.
 - Echo Error (EE). Bit 3 indicates echo word missing in transaction.
 - 0 = Echo word present
 - 1 = Missing echo word
 - Reserved. Bits 2-0 are reserved.
- MIL-STD-1553 16PP194 Intra-Packet Time Stamp. The IPTS (64 bits total) contains a 48-bit relative time stamp in the low-order bits. The 16 high-order bits are zero.
- d. Packet Format. Unless an error occurred, as indicated by one of the error flags in the IPDH, the first word following the length should always be the first transaction command word. The resultant packets have the format shown in [Table 11-21](#).

Table 11-21. MIL-STD-1553 16PP194 Data Packet	
msb	lsb
15	0
Packet Header	
Channel-Specific Data (Bits 15-0)	
Channel-Specific Data (Bits 31-16)	
Intra-Packet Time Stamp (Bits 0-15)	
Intra-Packet Time Stamp (Bits 31-16)	

Intra-Packet Time Stamp (Bits 32-47)
Intra-Packet Time Stamp (Bits 48-63)
Intra-Packet Data Header Status
Intra-Packet Data Header Length
Command (1) (Bits 31-16)
Command (1)(Bits 15-0)
Command (1) Echo(Bits 31-16)
Command (1) Echo (Bits 15-0)
Command (2) (Bits 31-16)
Command (2) (Bits 15-0)
Command (3) Go No-Go (Bits 31-16)
Command (3) Go No-Go (Bits 15-0)
Command (4) Go No-Go Echo (Bits 31-16)
Command (4) Go No-Go Echo (Bits 15-0)
Status (Bits 31-16)
Status (Bits 15-0)
Intra-Packet Time Stamp (Bits 0-15)
Intra-Packet Time Stamp (Bits 31-16)
Intra-Packet Time Stamp (Bits 32-47)
Intra-Packet Time Stamp (Bits 48-63)
Intra-Packet Data Header Status
Intra-Packet Data Header Length
Command (1) (Bits 31-16)
Command (1) (Bits 15-0)
Command (1) Echo (Bits 31-16)
Command (1) Echo (Bits 15-0)
Command (2) (Bits 31-16)
Command (2) (Bits 15-0)
Command (3) Go No-Go (Bits 31-16)
Command (3) Go No-Go (Bits 15-0)
Command (4) Go No-Go Echo (Bits 31-16)
Command (4) Go No-Go Echo (Bits 15-0)
Status (Bits 31-16)
Status (Bits 15-0)
Packet Trailer

- e. MIL-STD-1553 16PP194 Data Format. Each 26-bit 16PP194 word in a 16PP194 transaction shall be formatted into two 16-bit words ([Figure 11-25](#)). The corresponding 16PP194 sync and parity bits will not be formatted into the 16PP194 words.

msb								lsb
15	13	12	10	9	8	7		0
BUS ID		GAP		W	P	16PP194 Data Word (bits 24-17)		
16PP194 Data Word (bits 16-1)								

Figure 11-25. Military Standard 1553 26-Bit 16PP194 Word

- MIL-STD-1553 16PP194 Bus ID (BUS ID). A three-bit field shall be used to indicate bus identification as follows.

111	Communication interface unit (CIU) Left Bus A
110	CIU Left Bus B
101	CIU Right Bus A
100	CIU Right Bus B
011	Response Bus A and B
010	Response Bus A
001	Response Bus B
000	Incomplete Transaction

- MIL-STD-1553 16PP194 GAP (GAP). A three-bit field shall be used to indicate GAP between transactions as follows.

111	$GAP > 9.15 \mu s$
110	$7.55 \mu s < GAP \leq 9.15 \mu s$
101	$5.95 \mu s < GAP \leq 7.55 \mu s$
100	$4.35 \mu s < GAP \leq 5.95 \mu s$
011	$2.75 \mu s < GAP \leq 4.35 \mu s$
010	$2.75 \mu s < GAP \leq 4.35 \mu s$
001	$1.15 \mu s < GAP \leq 2.75 \mu s$
000	Not Applicable

 <p>NOTE</p>	<p>Gap time is measured from mid-crossing of the parity bit from the previous received word to mid-crossing of the sync bit of the current word in 1-μs counts.</p>
--------------------------------------------------------------------------------------------------------	-------------------------------------------------------------------------------------------------------------------------------------------------------------------------------------

- MIL-STD-1553 16PP194 Word Bit Error (W). If the bit is set to “1,” this indicates that a Manchester error was detected in the word.
- MIL-STD-1553 16PP194 Word Parity Error (P). If the bit is set to “1,” this indicates that a parity error occurred in the word.
- 16PP194 Data Word. Bits 16-1 contain the 16PP194 data field as in [Figure 11-26](#).

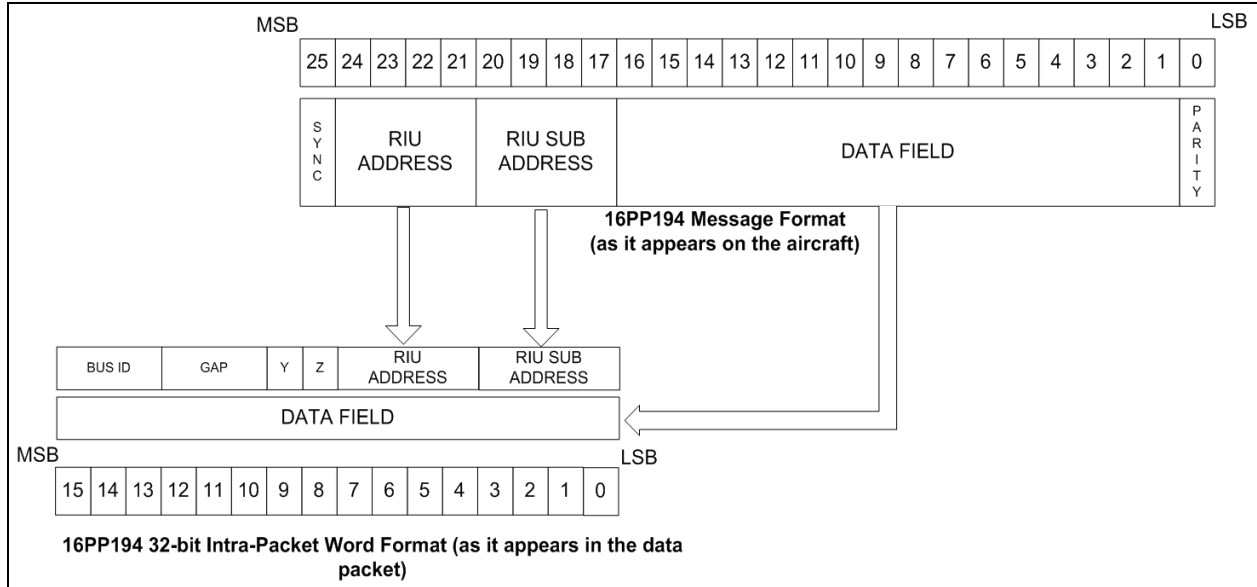

Figure 11-26. 16PP194 Word Format

- 16PP194 Data Word. Bits 24-17 contain the 16PP194 remote interface unit (RIU) address and RIU subaddress as in [Figure 11-26](#).

11.2.5 Analog Data Packets

11.2.5.1 Analog Data Packets, Format 0
Reserved.

11.2.5.2 Analog Data Packets, Format 1
The generic packet structure for analog data is illustrated in [Table 11-22](#).

Table 11-22. Generic Analog Data Packet, Format 1	
Packet Header	
Channel-Specific Data Word, Subchannel 1	
Channel-Specific Data Word, Subchannel 2	
:	
:	
:	
Channel-Specific Data Word, Subchannel M	
Sample 1	
Sample 2	
:	
:	
:	
Sample N	
Packet Trailer	

An analog data packet will contain a CSDW for each subchannel of analog data sampled within that packet if the SAME bit is set to 0, or it will contain a single CSDW for the entire analog packet if the SAME bit is set to 1. This will be followed by at least one complete sampling schedule of data.

A sampling schedule is defined as a sampling sequence in which each subchannel, described by a CSDW, is sampled at least once. In many cases, due to simultaneous sampling rules and varied sampling rates, a particular subchannel will be sampled more than once during a sampling schedule. In addition, multiple complete sampling schedules may be included in a single packet. For these reasons, the number of CSDWs will usually be less than the number of samples.

[Table 11-22](#) depicts the generic packet data structure for M data subchannels and a single sampling schedule that has a length N. Note that the width of the structure is not related to any number of bits and is merely intended to represent relative placement of words within the packet.

	<p>NOTE The packet header time in an analog data packet shall correspond to the first data sample in the packet. There are no IPHs in analog data packets.</p>
-----------------------------------------------------------------------------------	-----------------------------------------------------------------------------------------------------------------------------------------------------------------------

- a. Analog Packet Channel-Specific Data. The packet body portion of each analog packet begins with the CSDW(s). Each subchannel that is sampled with the packet sampling schedule must have a CSDW within the packet. Only one CSDW is required if subchannels are sampled at the same sampling rate (FACTOR), and have the same bits per sample (LENGTH) and same packing mode (MODE). Bit 28 of the CSDW shall be used to indicate same sampling data rate for subchannels.

The CSDWs for analog data packets are formatted as shown in [Figure 11-27](#).

msb										lsb															
31	29	28	27	24	23	16	15	8	7	2	1	0	31	29	28	27	24	23	16	15	8	7	2	1	0
RESERVED				SAME	FACTOR			TOTCHAN			SUBCHAN			LENGTH			MODE								

Figure 11-27. Analog Packet Channel-Specific Data Word

- Reserved. Bits 31-29 are reserved.
- Same. Bit 28 specifies if this CSDW applies for all the channels included in the packet or if each channel has its own CSDW.
 - 0 = Each analog channel has its own CSDW.
 - 1 = The CSDW is valid for all analog channels stored in this packet.
- Factor. Bits 27-24 are the exponent of the power of 2 sampling rate factor denominator for the corresponding subchannel in the range 0 to 15. (The sampling rate factor numerator is always 1.)
 - 0x0 = Sampling rate factor denominator $2^0 = 1 = >$ factor = 1/1
 - 0x1 = Sampling rate factor denominator $2^1 = 2 = >$ factor = 1/2
 - 0x2 = Sampling rate factor denominator $2^2 = 4 = >$ factor = 1/4
 - :

0xF = Sampling rate factor denominator $2^{15} = 32768 \Rightarrow \text{factor} = 1/32768$

- **Totchan.** Bits 23-16 indicate the total number of analog subchannels in the packet (and the number of CSDWs in the packet).

This field must be the same value in all CSDWs in a single packet. The Totchan value may be less than the largest Subchan value. This can happen when a multi-channel analog input device has some of its subchannels disabled (turned off) for a specific acquisition session. For example, if an analog input device has eight subchannels and not all eight are active, an analog data packet may have three subchannels (Totchan = 3) numbered 4, 7, and 8 (enabled Subchan = 4, 7, 8). The number of subchannels (Totchan) and the subchannel number for each active subchannel (Subchan) in a packet are identified in the accompanying Telemetry Attributes Transfer Standard (TMATS) (Computer-Generated Data, Format 1) packet.

0x00 = 256 subchannels
 0x01 = 1 subchannel
 0x02 = 2 subchannels

- **Subchan.** Bits 15-8 indicate a binary value representing the number or subchannel ID of the analog subchannel.

When an analog packet contains data from more than one subchannel and the CSDWs are not the same for all channels (see field Same, bit 28), the CSDWs must be inserted into the packet in ascending subchannel number as identified by this field. The Subchan values in these CSDWs need not be contiguous (see Totchan), but they must be in ascending decimal numerical order with the exception that subchannel 0 (256) is last. If the Same bit is set, the Subchan field shall be set to zero.

0x01 = Subchannel 1
 0x02 = Subchannel 2
 :
 0x00 = Subchannel 256
 :

- **Length.** Bits 7-2 indicate a binary value representing the number of bits in the analog-to-digital converter.

000000 = 64-bit samples
 000001 = 1-bit samples
 :
 001000 = 8-bit samples
 :
 001100 = 12-bit samples
 :

- **Mode.** Bits 1-0 indicate alignment and packing modes of the analog data. When Totchan is more than 1, MODE must be the same for all subchannels in a single packet.

00 = Data is packed
 01 = Data is unpacked, lsb padded

10 = Reserved for future definition
 11 = Data is unpacked, msb padded

 NOTE	For the special case of defining a single channel (Totchan = 1), there are two options: a) one channel with no subchannels; or b) one channel as its own subchannel. In such cases the bits are to be defined as follows.		
		One channel with no subchannel	One channel with one subchannel
	Totchan (bits 23-16)	1	1
	Same (bit 28)	1	0
	Subchan (bits 15-8)	0	1

- b. Analog Samples. A simultaneous sampling scheme shall be employed to preserve timing relationships and allow for accurate reconstruction of the data. The highest sampling rate required shall define the primary simultaneous sampling rate within the packet. The primary simultaneous sampling rate is identified in the TMATS file describing the attributes of the analog data packet. The rate at which the other subchannels are sampled is then defined by the sampling factor (1, 1/2, 1/4, 1/8, 1/16, 1/32768) for each subchannel. As an example, a sampling factor of 1/4 would yield that subchannel being sampled at one-fourth the primary simultaneous sampling rate and a sampling factor of 1 would yield that subchannel being sampled at the primary simultaneous sampling rate.

Directly following the CSDW(s), at least one complete sampling schedule shall be inserted in the packet. The samples, within the sampling sequence, may be inserted either unpacked, msb packed, or lsb packed as described in Subsection [11.2.5.2](#) items [b\(1\)](#) and [b\(2\)](#). In either case, one or more subchannels may be included in a single packet. When multiple subchannels are encapsulated into a single packet, the subchannel with the highest sampling rate requirement defines the primary simultaneous sampling rate. The rate at which the other subchannels are sampled is defined by the sampling factor (contained within the CSDWs). Sampling factors are defined as:

$$\left(\frac{1}{2^K}\right) * X \quad ; K = 0, 1, 2, 3, 4, 5, \dots$$

of the primary simultaneous sampling rate X.

The subchannels are then sampled and ordered such that:

- The highest sample rate 1*X subchannel(s) appear in every simultaneous sample;
- The $\left(\frac{1}{2}\right) * X$ subchannel(s) appear in every 2nd simultaneous sample;
- The $\left(\frac{1}{4}\right) * X$ subchannel(s) appear in every 4th simultaneous sample;

... and so on until all the subchannels are sampled, resulting in a complete sampling schedule of all subchannels described by the CSDWs. In doing so, the total number of simultaneous samples (not the total number of samples) will equal the denominator of the

smallest sampling factor and all subchannels will be sampled in the last simultaneous sample.

For example, a packet with six subchannels with sampling factors $\frac{1}{2}$, $\frac{1}{8}$, 1, $\frac{1}{2}$, 1, and $\frac{1}{8}$ respectively will yield a sampling sequence within the data packet as:

Simultaneous Sample 1:	Subchannel 3
Simultaneous Sample 1:	Subchannel 5
Simultaneous Sample 2:	Subchannel 1
Simultaneous Sample 2:	Subchannel 3
Simultaneous Sample 2:	Subchannel 4
Simultaneous Sample 2:	Subchannel 5
Simultaneous Sample 3:	Subchannel 3
Simultaneous Sample 3:	Subchannel 5
Simultaneous Sample 4:	Subchannel 1
Simultaneous Sample 4:	Subchannel 3
Simultaneous Sample 4:	Subchannel 4
Simultaneous Sample 4:	Subchannel 5
Simultaneous Sample 5:	Subchannel 3
Simultaneous Sample 5:	Subchannel 5
Simultaneous Sample 6:	Subchannel 1
Simultaneous Sample 6:	Subchannel 3
Simultaneous Sample 6:	Subchannel 4
Simultaneous Sample 6:	Subchannel 5
Simultaneous Sample 7:	Subchannel 3
Simultaneous Sample 7:	Subchannel 5
Simultaneous Sample 8:	Subchannel 1
Simultaneous Sample 8:	Subchannel 2
Simultaneous Sample 8:	Subchannel 3
Simultaneous Sample 8:	Subchannel 4
Simultaneous Sample 8:	Subchannel 5
Simultaneous Sample 8:	Subchannel 6

Notice that the denominator of the smallest sampling factor defines the number of simultaneous samples within the packet (in this example, 8); however, the total number of samples within the sampling schedule does not have to equal the number of simultaneous samples (in this example, 26). Also notice that all subchannels are sampled during the last simultaneous sample. The order of the subchannel samples in each simultaneous sample is ascending by subchannel number.

Any number of complete sampling schedules may be placed within a packet so that the maximum packet length is not exceeded.

- (1) Unpacked Mode. In unpacked mode, packing is disabled and each sample is padded with the number of bits necessary to align each word with the next 16-bit boundary in the packet. Four pad bits are added to 12-bit words, eight pad bits are added to 8-bit words, etc. All pad bits shall equal zero.

 NOTE	Samples less than 8 bits go into a 16-bit word boundary.
-----------------------------------------------------------------------------------------------	----------------------------------------------------------

To illustrate msb padding, given M analog subchannels mapping into N samples for the special case of all samples having bit lengths of 12 bits, the resultant analog packets with msb padding have the form shown in [Table 11-23](#).

Table 11-23. Analog Data Packet-Unpacked Mode, msb Padding	
msb	lsb
15	0
Packet Header	
Channel-Specific Data Word, Subchannel 1 (Bits 15-0)	
Channel-Specific Data Word, Subchannel 1 (Bits 31-16)	
Channel-Specific Data Word, Subchannel 2 (Bits 15-0)	
Channel-Specific Data Word, Subchannel 2 (Bits 31-16)	
:	
:	
:	
Channel-Specific Data Word, Subchannel M (Bits 15-0)	
Channel-Specific Data Word, Subchannel M (Bits 31-16)	
4 Pad Bits	Sample 1, 12 Data Bits
4 Pad Bits	Sample 2, 12 Data Bits
4 Pad Bits	Sample 3, 12 Data Bits
:	
4 Pad Bits	Sample N, 12 Data Bits
Packet Trailer	

To illustrate lsb packing, given M analog subchannels mapping into N samples for the special case of all samples having bit lengths of 12 bits, the resultant analog packets with lsb padding have the form shown in [Table 11-24](#).

Table 11-24. Analog Data Packet-Unpacked Mode, lsb Padding	
msb	lsb
15	0
Packet Header	
Channel-Specific Data Word, Subchannel 1 (Bits 15-0)	
Channel-Specific Data Word, Subchannel 1 (Bits 31-16)	
Channel-Specific Data Word, Subchannel 2 (Bits 15-0)	
Channel-Specific Data Word, Subchannel 2 (Bits 31-16)	
:	
:	
:	
Channel-Specific Data Word, Subchannel M (Bits 15-0)	

Channel-Specific Data Word, Subchannel M (Bits 31-16)	
:	
Sample 1, 12 Data Bits	4 Pad Bits
Sample 2, 12 Data Bits	4 Pad Bits
Sample 3, 12 Data Bits	4 Pad Bits
:	
Sample N, 12 Data Bits	4 Pad Bits
Packet Trailer	

- (2) Packed Mode. In packed mode, packing is enabled and padding is not added to each data word; however, if the number of bits in the packet are not an integer multiple of 16, then Y filler bits will be used to msb fill the last data word, forcing alignment on a 16-bit boundary. The value of Y is 16 minus the integer remainder of L, the total number of data bits in the packet, divided by 16 and is mathematically expressed as:

$$Y = 16 - (\text{MODULUS}\{L, 16\}).$$

To illustrate msb padding, given M analog subchannels mapping into N samples for the special case of all samples having bit lengths of 12 bits, the resultant analog packets with padding bits at the end of the Nth sample have the form shown in [Table 11-25](#).

Table 11-25. Analog Data Packet-Packed Mode Packet	
msb	lsb
15	0
Packet Header	
Channel-Specific Data Word, Subchannel 1 (Bits 15-0)	
Channel-Specific Data Word, Subchannel 1 (Bits 31-16)	
Channel-Specific Data Word, Subchannel 2 (Bits 15-0)	
Channel-Specific Data Word, Subchannel 2 (Bits 31-16)	
:	
:	
:	
Channel-Specific Data Word, Subchannel M (Bits 15-0)	
Channel-Specific Data Word, Subchannel M (Bits 31-16)	
Sample 2 (Bits 3-0)	Sample 1 (Bits 11-0)
Sample 3 (Bits 7-0)	Sample 2 (Bits 11-4)
:	:
:	:
:	:
Y Padding Bits	Sample N (Bits 11-0)
:	
Packet Trailer	

11.2.6 Discrete Data Packets

11.2.6.1 Discrete Data Packets, Format 0.
Reserved.

11.2.6.2 Discrete Data Packets, Format 1

A packet with discrete data has the basic structure shown in [Table 11-26](#). Note that the width of the structure is not related to any number of bits. This drawing is merely intended to represent relative placement of data in the packet. One to 32 discrete states may be recorded for each event.

Table 11-26. General Discrete Data Packet, Format 1
Packet Header
Channel-Specific Data
Intra-Packet Header for Event 1
Event 1 States
Intra-Packet Header for Event 2
Event 2 States
:
Intra-Packet Header for Event N
Event N States
Packet Trailer

- a. Discrete Packet Channel-Specific Data Word. The packet body portion of each discrete packet begins with the CSDW, which is formatted as shown in [Figure 11-28](#).

msb					lsb
31		8	7	3	2
RESERVED			LENGTH	MODE	
					0

Figure 11-28. Discrete Packet Channel Data Word

- Reserved. Bits 31-8 are reserved.
- Length. Bits 7-3 indicate a binary value representing the number of bits in the event. The value of zero indicates 32 bits.
- Mode. Bits 2-0 indicate the mode of accessing the discrete data.
 - Bit 0: indicates the record state.
 - 0 = discrete data is recorded when the state changes
 - 1 = discrete data is recorded on a time interval basis
 - Bit 1: indicates the alignment of the data.
 - 0 = lsb
 - 1 = msb
 - Bit 2: reserved.

- b. Discrete Data. After the channel-specific data, discrete data ([Figure 11-29](#)) is inserted in the packet. Discrete data are described as events. Each event includes the event state for each discrete input and the corresponding intra-packet time. The event state is a 32-bit word that provides the logical state of each discrete input.

msb			lsb	
31	30	...	1	0
D31	D30	...	D1	D0

Figure 11-29. Discrete Data Format

- Discrete Event Bits. Bits 31-0 indicate the states of the discrete event bits.

Bit 31: indicates discrete 31 (D31) state.

- 0 = discrete 31 is at state 0
- 1 = discrete 31 is at state 1

Bit 30: indicates discrete 30 (D30) state.

- 0 = discrete 30 is at state 0
- 1 = discrete 30 is at state 1

Bit 1: indicates discrete 1 (D1) state.

- 0 = discrete 1 is at state 0
- 1 = discrete 1 is at state 1

Bit 0: indicates discrete 0 (D0) state.

- 0 = discrete 0 is at state 0
- 1 = discrete 0 is at state 1

- c. Discrete Event Intra-Packet Header. All discrete events shall include an IPH consisting of an IPTS only, which is inserted immediately before the discrete event. The length of the IPH is fixed at 8 bytes (64 bits) positioned contiguously, arranged in the sequence shown in [Figure 11-30](#).

msb		lsb
31		0
Time (LSLW)		
Time (MSLW)		

Figure 11-30. Discrete Event Intra-Packet Header

- Intra-Packet Time Stamp. These 8 bytes indicate the time tag of the discrete event. First long word bits 31-0 and second long word bits 31-0 indicate the following values:
 - (1) The 48-bit RTC that corresponds to the first data bit of the discrete event with bits 31 to 16 in the second long word zero filled; or
 - (2) The absolute time, if enabled by bit 6 in the packet flags (Subsection [11.2.1.1](#) item [g](#)). The time format is indicated by bits 2 and 3 in the packet flags (Subsection [11.2.1.1](#) item [g](#)). The time tag shall be correlated to the first data bit of the discrete event. The discrete data packet format is presented in [Table 11-27](#).

Table 11-27. Discrete Data Packet Format	
msb	lsb
15	0
Packet Header	
Channel-Specific Data (Bits 15-0)	
Channel-Specific Data (Bits 31-16)	
Intra-Packet Time Stamp for Event 1 (Bits 15-0)	
Intra-Packet Time Stamp for Event 1 (Bits 31-16)	
Intra-Packet Time Stamp for Event 1 (Bits 47-32)	
Intra-Packet Time Stamp for Event 1 (Bits 63-48)	
States for Event 1 (Bits 15-0)	
States for Event 1 (Bits 31-16)	
:	
Intra-Packet Time Stamp for Event N (Bits 15-0)	
Intra-Packet Time Stamp for Event N (Bits 31-16)	
Intra-Packet Time Stamp for Event N (Bits 47-32)	
Intra-Packet Time Stamp for Event N (Bits 63-48)	
States for Event N (Bits 15-0)	
States for Event N (Bits 31-16)	
Packet Trailer	

11.2.7 Computer-Generated Data Packets

Packets with computer-generated data have the basic structure shown in [Table 11-28](#). Formats 0, 1, 2, 3, and 4 are used to add information packets to recorded data. This information contains annotation data, setup records, events, or index information for the data that has been recorded. The width of the structure is not related to any number of bits. This drawing is merely intended to represent relative placement of data in the packet.

 <p>NOTE</p>	<p>Computer-generated data is defined as non-external data or data generated within the recorder. After the CSDW, the computer-generated data is inserted in the packet. The organization and content of the computer-generated data is determined by the specific format type.</p>
--------------------------------------------------------------------------------------------------------	-------------------------------------------------------------------------------------------------------------------------------------------------------------------------------------------------------------------------------------------------------------------------------------

Table 11-28. General Computer-Generated Data Packet Format
Packet Header
Channel-Specific Data
Computer Generated Data
Packet Trailer

11.2.7.1 Computer-Generated Data Packets Format 0, User-Defined

Format 0 enables the insertion of user-defined computer-generated data. Data shall not be placed in packets of this type if the data type is already defined within this standard nor shall data be inserted in this packet if it is directly generated from an external input to the recorder.

- Format 0 Channel-Specific Data Word. The packet body portion of each Format 0 packet begins with the CSDW, which is formatted as shown in [Figure 11-31](#).
- Reserved. Bits 31-0 are reserved.

msb	lsb
31	0
RESERVED	

Figure 11-31. Computer-Generated Format 0 Channel-Specific Data Word

 NOTE	For this format, bits 31-0 are declared reserved; however, they are considered as “User” or “Application” defined.
-----------------------------------------------------------------------------------------------	--------------------------------------------------------------------------------------------------------------------

11.2.7.2 Computer-Generated Data Packets Format 1, Setup Records

Format 1 defines a setup record that describes the hardware, software, and data channel configuration used to produce the other data packets in the file. The organization and content of a Format 1 setup record is indicated in the CSDW FRMT field.

A single setup record may span multiple consecutive packets. When spanning multiple packets, the sequence counter shall increment in the order of segmentation of the setup record, $n+1$.

- Format 1 Channel-Specific Data Word. The packet body portion of each Format 1 packet begins with the CSDW, which is formatted as shown in [Figure 11-32](#).

Msb					lsb
31	10	9	8	7	0
RESERVED			FRMT	SRCC	RCCVER

Figure 11-32. Computer-Generated Format 1 Channel-Specific Data Word

- Reserved. Bits 31-10 are reserved.
- FRMT. Bit 9 is the setup record format.
 - 0 = Setup record IAW [Chapter 9](#) ASCII Format
 - 1 = Setup record IAW [Chapter 9](#) XML Format

 NOTE	It is not permissible to have both ASCII and XML Chapter 9 TMATS attributes in the same session (e.g., recording).
-------------------------------------------------------------------------------------------------	------------------------------------------------------------------------------------------------------------------------------------

- Setup Record Configuration Change (SRCC). Bit 8 indicates if the recorder configuration contained in the previous setup record packet(s) of the current recording session (defined as .RECORD to .STOP) has changed.
 - 0 = Setup record configuration has not changed
 - 1 = Setup record configuration has changed

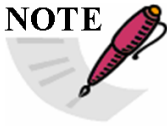
 <p>NOTE</p>	<p>When a setup record configuration change has taken place, bit 8 (SRCC) shall be set to 1 and the new setup record packet will be committed to the stream prior to any new or changed data packets being committed to the stream. The next setup record packet(s) committed to the stream, if not changed from this new setup record, shall clear the SRCC bit to 0.</p>
------------------------------------------------------------------------------------------------------	----------------------------------------------------------------------------------------------------------------------------------------------------------------------------------------------------------------------------------------------------------------------------------------------------------------------------------------------------------------------------

 <p>NOTE</p>	<p>Prior to the new setup record being committed to the stream, a setup record configuration change event packet shall be inserted into the stream.</p>
------------------------------------------------------------------------------------------------------	---------------------------------------------------------------------------------------------------------------------------------------------------------

 <p>NOTE</p>	<p>Each new setup record packet must adhere to all applicable setup record requirements including, but not limited to, the minimum required TMATS attributes.</p>
------------------------------------------------------------------------------------------------------	-------------------------------------------------------------------------------------------------------------------------------------------------------------------

- RCC 106 Version (RCCVER). Bits 7-0 specify which RCC release version applies and to which the following recorded data complies with. The value shall be represented by the following bit patterns.

0x00 through 0x06 = Reserved
 0x07 = RCC 106-07
 0x08 = RCC 106-09
 0x09 = RCC 106-11
 0x0A = RCC 106-13
 0x0B = RCC 106-15
 0x0C = RCC 106-17
 0x0D = RCC 106-19
 0x0E through 0xFF = Reserved

Individual Chapter 11 data types and their format/content compliance and applicability with the RCC release version are defined in Subsection [11.2.1.1](#) item [e](#).

Note that this field was known as “CH10VER” in RCC versions 106-04 through 106-15, where it was described in [Chapter 10](#) Subsection 10.6.7.2.

11.2.7.3 Computer-Generated Data Packets Format 2, Recording Event

Format 2 defines a “Recording Event” packet that contains the occurrence and information of one or more individual events that have been defined within the Format 1 setup record IAW “Recording Events” attribute. If the recording events information is larger than the maximum packet size of 512 KB, the recording events information may be contained in multiple packets using the major packet header sequence number.

Events associated with the .EVENT command defined in [Chapter 6](#) Subsection 6.2.4.13 can only be directly accessed from the acquisition system itself (e.g., recorder system) and are not contained within the output or recorded data. This does not preclude defining an event driven by the .EVENT command to also be defined within the recording event setup record information and placed in the appropriate event entry within an event packet. The .EVENT command and the

“Recording Event” packets will not be directly linked in this standard and any linking between the two will be an implementation of this standard within a recorder.

 <p>NOTE</p>	<p>It is not the intent for the event packets within the data to be directly coupled with recorder events per the .EVENT command in Chapter 6 Subsection 6.2.4.13.</p>
------------------------------------------------------------------------------------------------------	----------------------------------------------------------------------------------------------------------------------------------------------------------------------------------------

- a. Event Packet Location. Recording event packets may be placed at any location within the recording after the first time data packet and before the last root index packet. This may be at the time each event occurs, after multiple events have occurred, or at an interval of time or packets. The complete event log of a recording (defined in Subsection [11.2.7.3](#) item c) is constituted by the contents of all event packets in a recording concatenated in order of which the event(s) occurred in time.

 <p>NOTE</p>	<p>Index packets will be enabled if recording event packets are enabled. Note that Index packets are only meaningful if a Chapter 10 file is being used to record packets.</p>
------------------------------------------------------------------------------------------------------	--------------------------------------------------------------------------------------------------------------------------------------------------------------------------------

- b. Channel-Specific Data Word. The packet body portion of each Format 2 packet begins with the CSDW, which is formatted as shown in [Figure 11-33](#).

msb							lsb
31	30		12	11			0
IPDH		RESERVED			REEC		

Figure 11-33. Computer-Generated Format 2 Channel-Specific Data Word

- Recording Event Intra-Packet Data Header. Bit 31 indicates the presence of the IPDH.
 - 0 = Recording event IPDH not present
 - 1 = Recording event IPDH present
 - Reserved. Bits 30-12 are reserved.
 - Recording Event Entry Count (REEC). Bits 11-0 are an unsigned binary that identifies the count of recording event entries included in the packet.
- c. Event Period of Capture. The event period of capture ([Figure 11-34](#)) is defined to encompass the events occurring from the time a .RECORD command ([Chapter 6](#), Subsection 6.2.2.31) is issued (if it is the first recording) until the time a .STOP command ([Chapter 6](#), Subsection 6.2.3.9) is issued. If there is a previous recording, the period of capture is described as encompassing those events that occur from the previous recording’s .STOP command until the .STOP command of the current recording. This ensures that any events that occurred between recordings will be captured and will include special indicators that the event occurred between .STOP and .RECORD commands.

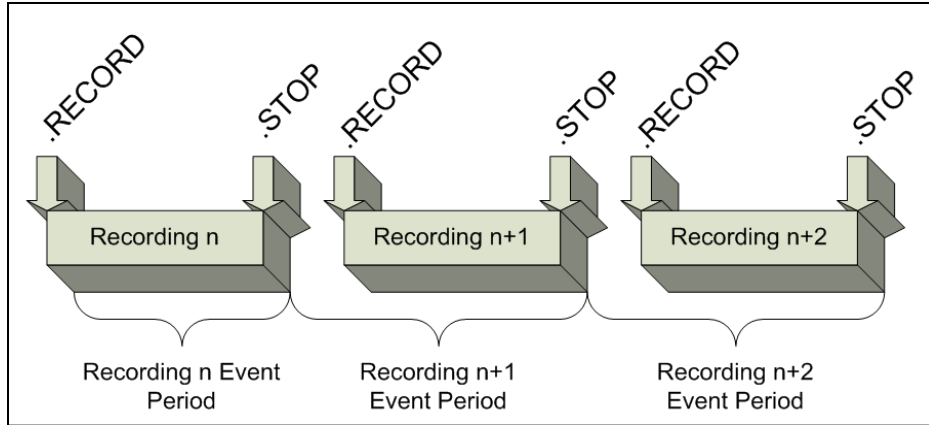

Figure 11-34. Events Recording Period

Priority conditions and event limit counts are defined in the setup record attributes for each defined event. The ability to put finite limits on events during periods of capture precludes overflowing buffers or media capacities. These priority conditions and event limit counts are as follows.

- Priority 1 The defined event will always be captured during and in between recordings.
- Priority 2 The defined event will always be captured during recordings and up to a limit count between recordings.
- Priority 3 The defined event will always be captured during recordings and not captured between recordings.
- Priority 4 The defined event will be captured up to a limit count during recordings and between recordings.
- Priority 5 The defined event will be captured up to a limit count for each defined event during recordings and not captured between recordings.

d. Event Condition of Capture. Event trigger mode conditions during the event period of capture are defined in the setup record attributes for each defined event. These MEASUREMENT DISCRETE, MEASUREMENT LIMIT, or MEASUREMENT CHANGE trigger mode conditions are as follows.

- Mode 1: Capture MEASUREMENT DISCRETE event at each On (1) and Off (0) mode transition sampling.
- Mode 2: Capture MEASUREMENT DISCRETE event at each On (1) mode transition sampling.
- Mode 3: Capture MEASUREMENT DISCRETE event at each Off (0) mode transition sampling.
- Mode 4: Capture MEASUREMENT LIMIT event at each high and low value transition sampling.
- Mode 5: Capture MEASUREMENT LIMIT event at each high value transition sampling.

Mode 6: Capture MEASUREMENT LIMIT event at each low value transition sampling.

Mode 7: Capture MEASUREMENT CHANGE event on each change of value from the previous value.

 <p>NOTE</p>	<p>If Event Type is MEASUREMENT DISCRETE, MEASUREMENT LIMIT, or MEASUREMENT CHANGE, the trigger measurement must be fully described using the setup record attributes for PCM, bus, analog, or discrete channels. The trigger measurement source and measurement name shall be identified in the event definition.</p>
------------------------------------------------------------------------------------------------------	------------------------------------------------------------------------------------------------------------------------------------------------------------------------------------------------------------------------------------------------------------------------------------------------------------------------

- e. Event Initial Capture. Event initial capture conditions are defined in the setup record attributes for each defined event. This determines if an event will be captured initially prior to the transition mode set for the event if the transition has already occurred prior to the event period of capture.

For a Mode 7 capture of a MEASUREMENT CHANGE event, there shall be an option for an initial value in the setup record that does not generate an event but each successive value change from this initial value shall generate an event. Event limit counts for mode 7 shall be valid on the number of events generated based on successive value changes from each previous value.

- f. Event Trigger Measurement Description. If Event Type is MEASUREMENT DISCRETE, MEASUREMENT LIMIT, or MEASUREMENT CHANGE, the event trigger measurement must be fully described using the setup record attributes for PCM, bus, analog, or discrete channels. This shall include at a minimum the following attributes for the trigger measurement.

- (1) Measurement source (via data link name)
- (2) Measurement name
- (3) Applicable measurement value definition or bit mask
- (4) High measurement value (if MEASUREMENT LIMIT at or above the high limit is used to trigger the event)
- (5) Low measurement value (if MEASUREMENT LIMIT at or below the low limit is used to trigger the event)
- (6) (Optional) Initial measurement value (if MEASUREMENT CHANGE is used to trigger the event)
- (7) Applicable measurement name engineering unit conversion

- g. Recording Event Intra-Packet Time Stamp. These 8 bytes indicate the time tag of the recording event entry as follows.

- (1) The 48-bit RTC that corresponds to the event entry with bits 31 to 16 in the second long word zero-filled. For event types that are MEASUREMENT DISCRETE or MEASUREMENT LIMIT, the time tag will correspond to the data packet timing mechanism containing the trigger measurement. This will either be the packet

header RTC value or, if enabled, the IPTS - whichever most accurately provides the time the event occurred; or

- (2) The absolute time, if enabled by bit 6 in the packet flags (Subsection [11.2.1.1](#) item [g](#)). The time format is indicated by bits 2 and 3 in the packet flags (Subsection [11.2.1.1](#) item [g](#)). The time tag shall be correlated to the event entry. For event types that are MEASUREMENT DISCRETE or MEASUREMENT LIMIT, the time tag will correspond to the data packet timing mechanism containing the trigger measurement. This will either be the packet secondary header or, if enabled and using an absolute time value, the IPTS - whichever most accurately provides the time the event occurred.
- h. (Optional) Recording Event Intra-Packet Data Header. These 8 bytes contain the absolute time of the event occurrence. The time source and format shall be derived from the Time Data Packet, Format 1. Unused high-order bits will be zero-filled as needed, depending on the time type of the time data packet. The format of the recording event IPH is presented in [Figure 11-35](#).

msb	lsb
31	0
Intra-Packet Time Stamp (LSLW)	
Intra-Packet Time Stamp (MSLW)	
(Optional) Intra-Packet Data Header (LSLW)	
(Optional) Intra-Packet Data Header (MSLW)	

Figure 11-35. Recording Event Intra-Packet Header

- i. Event Packet Entry Format. [Table 11-29](#) and [Figure 11-36](#) present the general recording event packet format and recording event entry layout.

Table 11-29. General Recording Event Packet Format
Packet Header
(Optional) Packet Secondary Header
Channel-Specific Data
Intra-Packet Time Stamp for Event 1
(Optional) Intra-Packet Data Header for Event 1
Recording Event 1
Intra-Packet Time Stamp for Event 2
(Optional) Intra-Packet Data Header for Event 2
Recording Event 2
:
Intra-Packet Time Stamp for Event N
(Optional) Intra-Packet Data Header for Event N
Recording Event N
Packet Trailer

 NOTE	Each recording file with indexes enabled shall have at a minimum one root index type packet.
-----------------------------------------------------------------------------------------------	----------------------------------------------------------------------------------------------

- Node Index Packets. These packets contain node item structures containing information about the location of data packets throughout the recording.

 NOTE	At a minimum, an index entry shall exist for each time data packet in the recording and, at a minimum, an index entry shall exist for each recording event packet in the recording.
-----------------------------------------------------------------------------------------------	-------------------------------------------------------------------------------------------------------------------------------------------------------------------------------------

 NOTE	If the recording index type uses a count rather than time, the time data packets and computer-generated data packets are not included in the count interval. -If the recording index type uses a time rather than count, the time data packets are not included in the time interval. If the time count value coincides with the time packet rate, then one index entry shall be created.
-----------------------------------------------------------------------------------------------	----------------------------------------------------------------------------------------------------------------------------------------------------------------------------------------------------------------------------------------------------------------------------------------------------------------------------------------------------------------------------------------------

 NOTE	If the recording indexes are enabled the Computer-Generated Data Packet, Format 1 setup record count or time interval value cannot be zero.
-----------------------------------------------------------------------------------------------	---------------------------------------------------------------------------------------------------------------------------------------------

- a. Recording Index Packet Location. If indexes are enabled, a root index packet ([Figure 11-37](#)) will be the last packet in any recording file. More than one root index type packet may be created and may be located within the recording. Root index packets are not required to be contiguous. Node index types may be placed at any location within the recording after the first time data packet and before the last root index packet. This may be at an interval of time or packets. If indexes are based on a time interval, the time interval shall be referenced to and based on 10 MHz RTC counts. When a time-based index time interval expiration takes place and all packet(s) are open (not generated), the index offset and time stamp will be based on the first of the opened packets generated. Packet generation and packet generation time shall apply per the definitions in Subsection [11.2.1](#).

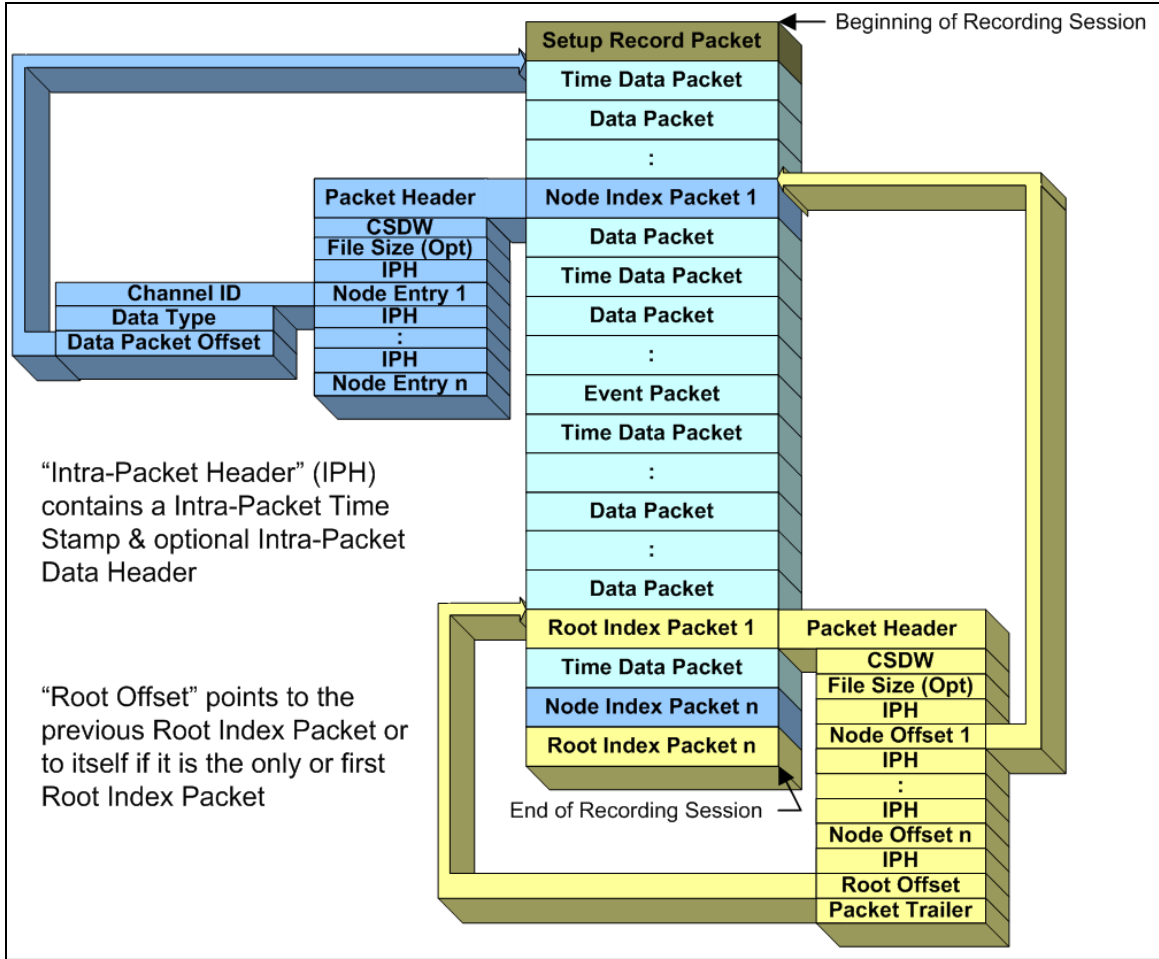

Figure 11-37. Format Showing Root Index Packet

b. Channel-Specific Data Word. The packet body portion of each Format 3 packet begins with the CSDW, which is formatted as shown in [Figure 11-38](#).

msb										lsb
31	30	29	28		16	15				0
IT	FSP	IPDH	RESERVED				INDEX ENTRY COUNT			

Figure 11-38. Computer-Generated Format 3 Channel-Specific Data Word

- Index Type (IT). Bit 31 indicates the type of index packet.
 - 0 = Root index
 - 1 = Node index
- File Size Present (FSP). Bit 30 indicates if the file size at the time the index packet was created is present.
 - 0 = File size not present
 - 1 = File size present
- Index Intra-Packet Data Header. Bit 29 indicates the presence of the IPDH.
 - 0 = Index IPDH not present

1 = Index IPDH present

- Reserved. Bits 28-16 are reserved.
- Index Entry Count. Bits 15-0 indicate the unsigned binary value of the number of index entries included in the packet. An integral number of complete index entries will be in each packet.

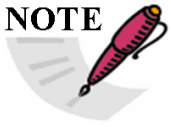
 <p>NOTE</p>	<p>The IPDH presence once set by bit 29 shall be the same state for the entire recording.</p>
------------------------------------------------------------------------------------------------------	-----------------------------------------------------------------------------------------------

- c. Recording Index Intra-Packet Time Stamp. These 8 bytes indicate the time tag of the recording index entry as follows.
- The 48-bit RTC that corresponds to the index entry, with bits 31 to 16 in the second long word zero-filled. For node index packets this corresponds to the first bit in the packet body of the packet associated with the node index item; or
 - The absolute time, if enabled by bit 6 in the packet flags (Subsection [11.2.1.1](#) item g). The time format is indicated by bits 2 and 3 in the packet flags (Subsection [11.2.1.1](#) item g). The time tag shall be correlated to the index entry. For node index packets this corresponds to the first bit in the packet body of the packet associated with the node index item.
- d. (Optional) Recording Index Intra-Packet Data Header. These 8 bytes contain the absolute time of the index entry. The time source and format shall be derived from the Time Data Packet, Format 1. Unused high-order bits will be zero-filled as needed, depending on the time type of the time data packet. [Figure 11-39](#) presents the format of the recording index IPH.

msb	lsb
31	0
Intra-Packet Time Stamp (LSLW)	
Intra-Packet Time Stamp (MSLW)	
(Optional) Intra-Packet Data Header (LSLW)	
(Optional) Intra-Packet Data Header (MSLW)	

Figure 11-39. Recording Index Intra-Packet Header

- e. Root Index Packet Entry Format. A root index packet contains a node index offset entry or entries using the format shown in [Table 11-30](#) and [Table 11-31](#).

Table 11-30. General Recording Root Index Packet
Packet Header
(Optional) Packet Secondary Header
Channel-Specific Data
(Optional) Root Index File Size
Intra-Packet Time Stamp for Node Index 1
(Optional) Intra-Packet Data Header for Node Index 1

Node Index Offset 1
:
Intra-Packet Time Stamp for Node Index N
(Optional) Intra-Packet Data Header for Node Index N
Node Index Offset N
Intra-Packet Time Stamp for Root Index
(Optional) Intra-Packet Data Header for Root Index
Root Index Offset
Packet Trailer

Table 11-31. Recording Root Index Entry Layout	
msb	lsb
31	0
(Optional) File Size (LSLW)	
(Optional) File Size (MSLW)	
Intra-Packet Time Stamp for Node Index 1 (LSLW)	
Intra-Packet Time Stamp for Node Index 1 (MSLW)	
(Optional) Intra-Packet Data Header for Node Index 1 (LSLW)	
(Optional) Intra-Packet Data Header for Node Index 1 (MSLW)	
Node Index Offset 1 (LSLW)	
Node Index Offset 1 (MSLW)	
:	
Intra-Packet Time Stamp for Node Index N (LSLW)	
Intra-Packet Time Stamp for Node Index N (MSLW)	
(Optional) Intra-Packet Data Header for Node Index N (LSLW)	
(Optional) Intra-Packet Data Header for Node Index N (MSLW)	
Node Index Offset N (LSLW)	
Node Index Offset N (MSLW)	
Intra-Packet Time Stamp for Root Index (LSLW)	
Intra-Packet Time Stamp for Root Index (MSLW)	
(Optional) Intra-Packet Data Header for Root Index (LSLW)	
(Optional) Intra-Packet Data Header for Root Index (MSLW)	
Root Index Offset (LSLW)	
Root Index Offset (MSLW)	

- (Optional) Root Index File Size. These 8 bytes are an unsigned binary that identifies the current size in bytes of the file at the time the root index packet was created and placed into the recording. This value should be the same as the root index offset. The file size is required when a recording is split across multiple media, individual or multiple channels are split from the original recording file, or time slices are extracted from the original recording. In all cases the original recording file size will allow recalculation and/or replacement of the index offsets when required.

- Node Index Offset. These 8 bytes are an unsigned binary that identifies the zero-based byte offset from the beginning of the recording file to the point in the file at which the node index packet sync pattern (0xEB25) begins.
 - Root Index Offset. These 8 bytes are an unsigned binary that identifies the zero-based byte offset from the beginning of the recording file to the point in the file at which the previous root index packet in its chain begins, if there is more than one root index packet or to itself, if it is the first or only root index packet.
- f. Node Index Packet Entry Format. A node index packet contains an index entry or entries using the format shown in [Table 11-32](#) and [Figure 11-40](#).

Table 11-32. General Recording Node Index Packet	
Packet Header	
(Optional) Packet Secondary Header	
Channel-Specific Data	
(Optional) Node Index File Size	
Intra-Packet Time Stamp for Node Index 1	
(Optional) Intra-Packet Data Header for Node Index 1	
Recording Node Index 1	
Intra-Packet Time Stamp for Node Index 2	
(Optional) Intra-Packet Data Header for Node Index 2	
Recording Node Index 2	
:	
Intra-Packet Time Stamp for Node Index N	
(Optional) Intra-Packet Data Header for Node Index N	
Recording Node Index N	
Packet Trailer	

msb					lsb
31	24	23	16	15	0
Reserved		Data Type		Channel ID	
Data Packet Offset (LSLW)					
Data Packet Offset (MSLW)					

Figure 11-40. Recording Node Index Entry Layout

- (Optional) Node Index File Size. These 8 bytes are an unsigned binary that identifies the current size in bytes of the file at the time the node index packet was created and placed into the recording. This value should be the same as the node index offset. The file size is required when a recording is split across multiple media, individual or multiple channels are split from the original recording file, or time slices are extracted from the original recording. In all cases the original recording file size will allow recalculation and/or replacement of the index offsets when required.
- Channel ID. These 2 bytes are an unsigned binary that identifies a value representing the packet channel ID for the data packet associated with this node index item.

- Data Type. This byte is an unsigned binary that identifies a value representing the type and format of the data packet associated with this node index item.
- Data Packet Offset. These 8 bytes are an unsigned binary that identifies the zero-based byte offset from the beginning of the recording file to the point in the file at which the data packet sync pattern (0xEB25) begins for this node index packet item.

11.2.7.5 Computer-Generated Data Packets Format 4, Streaming Configuration Records

Format 4 is used to report the active streaming or recording configuration of the system. The organization and content of a Format 4 Streaming Configuration record is indicated in the CSDW FRMT field.

A single Streaming Configuration record may span multiple packets. When spanning occurs, no other Format 4 Computer-Generated Data Packet shall be interspersed, although other packet types are permitted between segments of a Format 4 packet. When spanning multiple packets, the segments shall be output in order, and the last segment shall be flagged in the CSDW.

- Format 4 Channel-Specific Data Word. The packet body portion of each Format 4 packet begins with the CSDW, which is formatted as shown in [Figure 11-41](#).

msb							lsb
31		16	15	14		8	7
RESERVED			LAST	FRMT		RCCVER	

Figure 11-41. Computer-Generated Format 4 Channel-Specific Data Word

- Reserved. Bits 31-16 are reserved.
- FRMT. Bits 14-8 contain the streaming configuration record format according to the following bit patterns:
 - 000 0000 = Complete record IAW [Chapter 9](#) ASCII Format
 - 000 0001 = Complete record IAW [Chapter 9](#) XML Format
 - 000 0010 = Segmented part of an ASCII Format record
 - 000 0011 = Segmented part of an XML Format record
 - 000 0100 = SHA2-256 Checksum
 - 000 0101 = Currently Selected Channels
- LAST. Bit 15 that the current packet is the last packet of a series of segmented packets. Ignored if the FRMT bits do not denote a segmented record.
 - 0 = The current packet is not the last packet.
 - 1 = The current packet is the last packet in a segmented series.
- RCC 106 Version (RCCVER). Bits 7-0 specify which RCC release version applies and to which the following recorded data complies with. The value shall be represented by the following bit patterns.
 - 0x00 through 0x0B = Reserved
 - 0x0C = RCC-106-17
 - 0x0D through 0xFF = Reserved

Individual Chapter 11 data types and their format/content compliance and applicability with the RCC release version are defined in Subsection [11.2.1.1](#) item [e](#).

- b. **Full or Segmented ASCII or XML Format Records.** Immediately following the CSDW in the case of the complete or segmented versions of either the ASCII or XML variants of the full TMATS configuration record shall be the text of the TMATS record, or (if segmented) the text that immediately sequentially follows the last character of the previous segmented part of the TMATS record.
- c. **SHA2-256 Checksum.** Immediately following the CSDW shall be 32 bytes containing the binary representation of the 256-bit SHA2 checksum, calculated IAW [Chapter 6](#) Subsection 6.2.3.11.f. This structure is shown in [Table 11-33](#). Note that Subsection 6.2.3.11.f and the [Chapter 9](#) “G\SHA” attribute both reference hexadecimal representations of the binary value used in this record.

Table 11-33. SHA2-256 Checksum Packet Layout	
msb	lsb
31	0
Packet Header	
Channel-Specific Data (Bits 31-0)	
Checksum bits 255-224	
Checksum bits 223-192	
Checksum bits 191-160	
Checksum bits 159-128	
Checksum bits 127-96	
Checksum bits 95-64	
Checksum bits 63-32	
Checksum bits 31-0	
Packet Trailer	

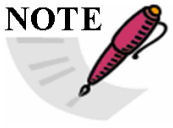
 <p>NOTE</p>	<p>To avoid confusion, the “big endian” format referenced by FIPS 180-2 shall be used. Thus each 32 bit portion of the checksum shown above shall be treated as “big endian”.</p>
--------------------------------------------------------------------------------------------------------	-----------------------------------------------------------------------------------------------------------------------------------------------------------------------------------

- d. **Currently Selected Channels.** Immediately following the CSDW shall be a 16-bit count of the number of 16-bit words that follow, with each following word providing the channel ID of a channel currently selected (or enabled) for output. This structure is shown in [Table 11-34](#). The order of the channels in the body of the record is implementation-dependent.

Table 11-34. Currently Selected Channel Layout	
msb	lsb
15	0
Packet Header	
Channel-Specific Data (Bits 15-0)	

Channel-Specific Data (Bits 31-16)
Number of Valid Channels to follow
Channel ID #1
Channel ID #2
:
Channel ID #n
[optional filler bytes]
Packet Trailer

11.2.8 ARINC-429 Data Packets

11.2.8.1 ARINC-429 Data Packets, Format 0

Data shall be packetized in word mode: each 32-bit word of an ARINC-429 bus shall be preceded by an IPH containing an IPDH only with an identifier (ID word) that provides type and status information. The IPH does not contain an IPTS. The packet time in the packet header is the time of the first ARINC data word in the packet, and the time of successive ARINC data words is determined from the first word time using the gap times in the ID words that precede each of the data words. Multiple words of multiple ARINC-429 buses can be inserted into a single packet. The resultant packets shall have the following format as shown in [Table 11-35](#).

Table 11-35. ARINC-429 Data Packet Format	
msb	lsb
15	0
Packet Header	
Channel-Specific Data (Bits 15-0)	
Channel-Specific Data (Bits 31-16)	
Word 1 Intra-Packet Data Header	
Word 1 Intra-Packet Data Header	
ARINC-429 Data Word 1 (Bits 15-0)	
ARINC-429 Data Word 1 (Bits 31-16)	
Word 2 Intra-Packet Data Header	
Word 2 Intra-Packet Data Header	
ARINC-429 Data Word 2 (Bits 15-0)	
ARINC-429 Data Word 2 (Bits 31-16)	
:	
Word N Intra-Packet Data Header	
Word N Intra-Packet Data Header	
ARINC-429 Data Word N (Bits 15-0)	
ARINC-429 Data Word N (Bits 31-16)	
Packet Trailer	

 <p>NOTE</p>	<p>Time tagging of ARINC-429 shall correspond to the first data bit of the packet.</p>
--------------------------------------------------------------------------------------------------------	----------------------------------------------------------------------------------------

- a. ARINC-429 Packet Channel-Specific Data Word. The packet body portion of each ARINC-429 data packet shall begin with a CSDW formatted as shown in [Figure 11-42](#).

msb										lsb
31				16	15					0
RESERVED					MSGCOUNT					

Figure 11-42. ARINC-429 Packet Channel-Specific Data Word

- Reserved. Bits 31-16 are reserved
 - Message Count (MSGCOUNT). Bits 15-0 indicate the binary value of the number of ARINC-429 words included in the packet.
- b. Intra-Packet Data Header. Bits 31-0 contain the ARINC-429 ID word. Each ARINC-429 bus data word is preceded by an ID word and the bit definitions are as shown in [Figure 11-43](#).

msb										lsb
31		24	23	22	21	20	19			0
BUS			FE	PE	BS	R	GAP TIME			

Figure 11-43. Intra-Packet Data Header Format

- Bus. Bits 31-24 indicate a binary value identifying the ARINC-429 bus number associated with the following data word. The first bus is indicated by 0. A maximum of 256 buses can be placed in one packet.
 - Format Error (FE). Bit 23 indicates an ARINC-429 format error.
 - 0 = No format error has occurred
 - 1 = Format error has occurred
 - Parity Error (PE). Bit 22 indicates an ARINC-429 parity error.
 - 0 = No parity error has occurred
 - 1 = Parity error has occurred
 - Bus Speed (BS). Bit 21 indicates the ARINC-429 bus speed the data is from.
 - 0 = Indicates low-speed ARINC-429 bus (12.5 kHz)
 - 1 = Indicates high-speed ARINC-429 bus (100 kHz)
 - Reserved (R). Bit 20 is reserved.
 - Gap Time (GAP TIME). Bits 19-0 contain a binary value that represents the gap time from the beginning of the preceding bus word (regardless of bus) to the beginning of the current bus word in 0.1- μ s increments. The gap time of the first word in the packet is GAP TIME = 0. When the gap time is longer than 100 ms, a new packet must be started.
- c. ARINC-429 Packet Data Words. The data words shall be inserted into the packet in the original 32-bit format as acquired from the bus.

11.2.9 Message Data Packets

11.2.9.1 Message Data Packets, Format 0

The data from one or more separate serial communication interface channels can be placed into a message data packet ([Table 11-36](#)).

Table 11-36. Message Data Packet Format	
msb	lsb
15	0
Packet Header	
Channel-Specific Data (Bits 15-0)	
Channel-Specific Data (Bits 31-16)	
Intra-Packet Time Stamp for Msg 1 (Bits 15-0)	
Intra-Packet Time Stamp for Msg 1 (Bits 31-16)	
Intra-Packet Time Stamp for Msg 1 (Bits 47-32)	
Intra-Packet Time Stamp for Msg 1 (Bits 63-48)	
Intra-Packet Data Header for Msg 1 (Bits 15-0)	
Intra-Packet Data Header for Msg 1 (Bits 31-16)	
Byte 2	Byte 1
:	:
Filler (if N is Odd)	Byte N
:	
Intra-Packet Time Stamp for Msg N (Bits 15-0)	
Intra-Packet Time Stamp for Msg N (Bits 31-16)	
Intra-Packet Time Stamp for Msg N (Bits 47-32)	
Intra-Packet Time Stamp for Msg N (Bits 63-48)	
Intra-Packet Data Header for Msg N (Bits 15-0)	
Intra-Packet Data Header for Msg N (Bits 31-16)	
Byte 2	Byte 1
:	:
Filler (if N is Odd)	Byte N
Packet Trailer	

- a. Message Packet Channel-Specific Data Word. The packet body portion of each message data packet begins with a CSDW. It indicates if the packet body contains several short messages (type: complete) or one segment of a long message (type: segmented).
- b. Complete Message Channel-Specific Data Word. The CSDW is formatted for the complete type of packet body as shown in [Figure 11-44](#).

msb	lsb
31	0
18 17 16 15	
RESERVED	TYPE COUNTER

Figure 11-44. Complete Message Channel-Specific Data Word

- Reserved. Bits 31-18 are reserved.

- Type. Bits 17-16 indicate the type of serial packet.
 - 00 = One or more complete messages
 - 01 = Reserved
 - 10 = Reserved
 - 11 = Reserved
 - Counter. Bits 15-0 contain a binary value indicating the number of messages included in the packet.
- c. Segmented Message Channel-Specific Data Word. The CSDW is formatted for the segmented type of packet body as shown in [Figure 11-45](#).

msb						lsb
31	18	17	16	15		0
RESERVED			TYPE	COUNTER		

Figure 11-45. Segmented Message Channel-Specific Data Word

- Reserved. Bits 31-18 are reserved.
 - Type. Bits 17-16 indicate the type of serial packet.
 - 00 = Reserved
 - 01 = Packet is a beginning of a long message from a single source
 - 10 = Whole packet is the last part of a long message from a single source
 - 11 = Whole packet is a middle part of a long message from a single source
 - Counter. Bits 15-0 contain a binary value indicating the segment number of a long message. The number must start with 1 and must be incremented by one after each packet. The maximum length of a single long message is 4 gigabytes (combined with the 16-bit Message Length field; see description in item d below).
- d. Message Data Intra-Packet Header. After the channel-specific data, message data is inserted into the packet. Each message is preceded by an IPH that has both an IPTS and an IPDH containing a message ID word. The length of the IPH is fixed at 12 bytes (96 bits) positioned contiguously, in the sequence shown in [Figure 11-46](#).

msb						lsb
31						0
Time (LSLW)						
Time (MSLW)						
Message ID Word						

Figure 11-46. Message Data Intra-Packet Header

- Intra-Packet Time Stamp. These 8 bytes indicate the time tag of the message data. First long word bits 31-0 and second long word bits 31-0 indicate the following values.
 - (3) The 48-bit RTC that corresponds to the first data bit in the message with bits 31 to 16 in the second long word zero-filled; or

- (4) The absolute time, if enabled by bit 6 in the packet flags (Subsection [11.2.1.1](#) item [g](#)). The time format is indicated by bits 2 and 3 in the packet flags (Subsection [11.2.1.1](#) item [g](#)). The time tag shall be correlated to the first data bit in the message.
- Intra-Packet Data Header. The IPDH is an identification word (message ID word) that precedes the message and is inserted into the packet with the format shown in [Figure 11-47](#).

msb														lsb	
31	30	29							16	15					0
DE	FE	SUBCHANNEL						MESSAGE LENGTH							

Figure 11-47. Intra-Packet Data Header Format

- Data Error (DE). Bit 31 indicates bad data bits as determined by parity, checksums, or cyclic redundancy check words received with the data.
 - 0 = No data error has occurred
 - 1 = Data error has occurred
- Format Error (FE). Bit 30 indicates a protocol error, such as out-of-sequence data or length errors.
 - 0 = No format error
 - 1 = Format error encountered
- Subchannel. Bits 29-16 contain a binary value that represents the subchannel number belonging to the message that follows the ID word when the channel ID in the packet header defines a group of subchannels. Zero means first and/or only subchannel.
- Message Length. Bits 15-0 contain a binary value representing the length of the message in bytes (*n*) that follows the ID word. The maximum length of a message (complete) or a message segment (segmented) is 64 KB.

11.2.10 Video Packets

11.2.10.1 Video Packets, Format 0 (Moving Picture Experts Group-2/H.264)

Format 0 Moving Picture Experts Group (MPEG)-2/H.264 encoding will be IAW Department of Defense Motion Imagery Standards Profile (MISP) Standard 9601.⁶ The MPEG-2/H.264 format will be transport streams (TS) per MISP Recommended Practice (RP) 0101.1.⁷ The TS will be encapsulated at a constant bit rate (CBR) within the limits of MPEG-2 MP@ML

⁶ Motion Imagery Standards Board. “Standard Definition Digital Motion Imagery, Compression Systems.” STD 9601 in *Motion Imagery Standards Profile*. MISP 6.4. 4 October 2012. Updated by MISP-2019.1. Retrieved 6 July 2020. Available at <http://www.gwg.nga.mil/misb/docs/misp/MISP-6.4.pdf>.

⁷ Motion Imagery Standards Board. “Use of MPEG-2 System Streams in Digital Motion Imagery Systems.” RP 0101.1. 27 January 2011. Superseded by MISB ST 1402. Retrieved 6 July 2020. Available at <http://www.gwg.nga.mil/misb/docs/rp/RP0101.1.pdf>.

and H.264 MP@L3 specifications per MISP Recommended Practice 9720d⁸ for further standardization and telemeter/transmission requirements of the video.

These MPEG-2/H.264 algorithm features are combined to produce an encoded video stream that will be encapsulated in Format 0 packets. The H.264 can be carried over the MPEG-2 TSs using International Telecommunications Union/Telecommunication Standardization Sector (ITU-T) Recommendation H.222.0⁹ for MPEG2 TS containment for MPEG4 advanced video codec. The MISP has adapted this with 9720d and 9701.

The TSs are limited to a single program stream (PS) using program elementary stream (PES) packets that share the same common time base. A TS must contain the program association table (PAT) and program map table (PMT) that define the program ID (PID) for the program clock reference (PCR) stream. The PSs also must contain at least one packet header.

A packet with Format 0 MPEG-2/H.264 video data has the basic structure shown in [Table 11-37](#). Note that the width of the structure is not related to any number of bits. This figure is merely intended to represent relative placement of data in the packet.

Table 11-37. General MPEG-2/H.264 Video Packet, Format 0
Packet Header
Channel-Specific Data
(Optional) Intra-Packet Header
188-Byte TS Data
(Optional) Intra-Packet Header
188-Byte TS Data
:
(Optional) Intra-Packet Time Header
188-Byte TS Data
(Optional) Intra-Packet Time Header
188-Byte TS Data
Packet Trailer

- a. **Video Packet Audio.** When recording video using Format 0, if audio is present it will be inserted into the TS per ISO/IEC 13818-3¹⁰ for MPEG-2 and ISO/IEC 14496-3¹¹ for H.264. A separate analog channel to specifically record audio will not be required as

⁸ Motion Imagery Standards Board. “Motion Imagery Systems Matrix, Standard Definition Motion Imagery.” RP 9720d in *Motion Imagery Standards Profile*. MISP 6.4. 4 October 2012. Updated by MISP-2019.1. Retrieved 6 July 2020. Available at <http://www.gwg.nga.mil/misb/docs/misp/MISP-6.4.pdf>.

⁹International Telecommunications Union Telecommunication Standardization Sector. *Information technology - Generic coding of moving pictures and associated audio information: Systems*. ITU-T Rec.H.222.0 (08/18). 29 August 2018. May be superseded by update. Retrieved 6 July 2020. Available at <http://www.itu.int/rec/T-REC-H.222.0/en>.

¹⁰ ISO/IEC. *Information technology--Generic coding of moving pictures and associated audio information -- Part 3, Audio*. ISO/IEC 13818-3:1998. Geneva: International Organization for Standardization, 1998.

¹¹ ISO/IEC. *Information Technology - Coding of Audio-Visual Objects - Part 3: Audio*. ISO/IEC 14496-3:2019. 12 December 2019. May be superseded by update. Retrieved 6 July 2020. Available for purchase at <https://webstore.iec.ch/publication/63839>.

MPEG-2/H.264 supports audio insertion into the TS. By combining video and audio, recording bandwidth and memory capacity will be increased.

- b. Video Packet Channel-Specific Data Word. The packet body portion of each Format 0 packet begins with the CSDW, formatted as shown in [Figure 11-48](#).

msb							lsb	
31	30	29	28	27	24	23	22	0
ET	IPH	SRS	KLK	PL		BA	RESERVED	

Figure 11-48. Video Packet Channel-Specific Data Word

- Embedded Time (ET). Bit 31 indicates if embedded time is present in the MPEG-2 video data.
 - 0 = No embedded time present
 - 1 = Embedded time is present

MPEG-2 stream embedded time if utilized will be IAW MISP Standard 9708¹² and Standard 9715¹³. Embedded time is used for the synchronization of core MPEG-2 data when extracted from the Chapter 10 domain (i.e., an export to MPEG-2 files).
- Intra-Packet Header. Bit 30 indicates if IPTSs are inserted before each transport packet.
 - 0 = Intra-packet times not present
 - 1 = Intra-packet times present
- SCR/RTC Sync (SRS). Bit 29 indicates if the MPEG-2 SCR is RTC.
 - 0 = SCR is not synchronized with the 10 MHz RTC
 - 1 = SCR is synchronized with the 10 MHz RTC

The TSs contain their own embedded time base used to facilitate the decoding and presentation of video and/or audio data at the decoder. Within a PS, all streams are synchronized to a single time source referred to as the system clock reference (SCR). Within a TS, each embedded program contains its own PCR, requiring that each Format 0-encoded MPEG-2/H.264 TS contains only a single program allowing each format to be treated in a similar manner using a single global clocking reference.

The 10 MHz RTC is for the purposes of synchronizing and time-stamping the data acquired from multiple input sources. For input sources that don't define an explicit timing model for data presentation, superimposing this timing model can be accomplished. For MPEG-2/H.264, however, an explicit synchronization model based on a 27 MHz clock is defined for the capture, compression, decompression, and presentation of MPEG-2/H.264 data. In order to relate the two different timing models, the MPEG-2/H.264 SCR/PCR time stamps (if enabled) will be derived from

¹² Motion Imagery Standards Board. "Imbedded Time Reference for Motion Imagery Systems." STD 9708 in *Motion Imagery Standards Profile*. MISP 6.4. 4 October 2012. Updated by MISP-2019.1. Retrieved 6 July 2020. Available at <http://www.gwg.nga.mil/misb/docs/misp/MISP-6.4.pdf>.

¹³ Motion Imagery Standards Board. "Time Reference Synchronization." STD 9715 in *Motion Imagery Standards Profile*. MISP 6.4. 4 October 2012. Updated by MISP-2019.1. Retrieved 6 July 2020. Available at <http://www.gwg.nga.mil/misb/docs/misp/MISP-6.4.pdf>.

the 10-MHz RTC timing reference source (by generating the 27-MHz MPEG-2/H.264 reference clock slaved to the 10-MHz RTC).

MPEG-2/H.264 defines the SCR/PCR time stamp as a 42-bit quantity, consisting of a 33-bit base value and a 9-bit extension value. The exact value is defined as:

$$\text{SCR} = \text{SCR_base} * 300 + \text{SCR_ext}$$

where:

$$\text{SCR_base} = [(\text{system_clock_frequency} * t) / 300] \text{ MOD } 233$$

$$\text{SCR_ext} = [(\text{system_clock_frequency} * t) / 1] \text{ MOD } 300$$

For recording periods of less than 26.5 hours, the SCR can be directly converted into the 10-MHz RTC using the equation:

$$10\text{-MHz RTC time base} = \text{SCR} * 10/27 \text{ (rounded to nearest integer)}$$

For recording periods longer than this, the Format 0 packet header time stamp can be used to determine the number of times the MPEG-2/H.264 SCR has rolled over and calculate the upper 8 bits of the free-running counter's value.

- Key-Length-Value. Bit 28 indicates if key-length-value (KLV) metadata is present in the MPEG-2 video data.

0 = No KLV metadata present

1 = KLV metadata is present

MPEG-2/H.264 stream KLV metadata, if utilized, will be IAW the following MISP documents:

- Standard 9711¹⁴
- Standard 9712¹⁵
- Standard 9713¹⁶
- Recommended Practice 9717¹⁷
- Standard 0107.1.¹⁸

¹⁴ Motion Imagery Standards Board. "Intelligence Motion Imagery Index, Geospatial Metadata." STD 9711 in *Motion Imagery Standards Profile*. MISP 6.4. 4 October 2012. Updated by MISP-2019.1. Retrieved 6 July 2020. Available at <http://www.gwg.nga.mil/misb/docs/misp/MISP-6.4.pdf>.

¹⁵ Motion Imagery Standards Board. "Intelligence Motion Imagery Index, Content Description..." STD 9712 in *Motion Imagery Standards Profile*. MISP 6.4. 4 October 2012. Updated by MISP-2019.1. Retrieved 6 July 2020. Available at <http://www.gwg.nga.mil/misb/docs/misp/MISP-6.4.pdf>.

¹⁶ Motion Imagery Standards Board. "Data Encoding Using Key-Length-Value." STD 9713 in *Motion Imagery Standards Profile*. MISP 6.4. 4 October 2012. Updated by MISP-2019.1. Retrieved 6 July 2020. Available at <http://www.gwg.nga.mil/misb/docs/misp/MISP-6.4.pdf>.

¹⁷ Motion Imagery Standards Board. "Packing KLV Packets into MPEG-2 Systems Streams." RP 9717 in *Motion Imagery Standards Profile*. MISP 6.4. 4 October 2012. Updated by MISP-2019.1. Retrieved 6 July 2020. Available at <http://www.gwg.nga.mil/misb/docs/misp/MISP-6.4.pdf>.

¹⁸ Motion Imagery Standards Board. *Bit and Byte Order for Metadata in Motion Imagery Files and Streams*. STD 107.1. June 2011. Superseded by ST 0107.4. Retrieved 6 July 2020. Available at <http://www.gwg.nga.mil/misb/docs/standards/ST0107.1.pdf>.

- Payload (PL). Bits 27-24 indicate the payload type within the MPEG-2 stream per MISP Xon2.¹⁹

0000 = MPEG-2 MP @ ML
 0001 = H.264 MP @ L2.1
 0010 = H.264 MP @ L2.2
 0011 = H.264 MP @ L3
 0100-1111 = Reserved.

- Byte Alignment (BA). Bit 23 indicates the MPEG-2 data payload byte alignment within 16-bit words.

0 = Little-endian as referenced in [Figure 11-49](#).
 1 = Big-endian as referenced in [Figure 11-50](#).

msb	lsb
15	0
TS Sync Byte (Bits 0 to 7)	TS Data (Bits 8 to 15)
TS Data (Bits 16 to 23)	TS Data (Bits 24 to 31)
:	
TS Data (Bits 1488 to 1495)	TS Data (Bits 1496 to 1503)

Figure 11-49. Format 0 MPEG-2/H.264 Video Frame Format, 16-Bit Little-Endian Aligned

msb	lsb
15	0
TS Data (Bits 8 to 15)	TS Sync Byte (Bits 0 to 7)
TS Data (Bits 24 to 31)	TS Data (Bits 16 to 23)
:	
TS Data (Bits 1496 to 1503)	TS Data (Bits 1488 to 1495)

Figure 11-50. Format 0 MPEG-2/H.264 Video Frame Format, 16-Bit Big-Endian (Native) Aligned

- Reserved. Bits 22-0 are reserved.
- c. Intra-Packet Header. If enabled, the IPH shall include a 64-bit IPTS, which is inserted immediately before the TS sync pattern. The length of the IPH is fixed at 8 bytes (64 bits) positioned contiguously, in [Figure 11-51](#).

msb	lsb
31	0
Time (LSLW)	
Time (MSLW)	

Figure 11-51. Video Packet, Format 0 Intra-Packet Header

¹⁹ Motion Imagery Standards Board. "Xon2". Subsection D-1.2 in *Motion Imagery Standards Profile*. MISP 6.4. 4 October 2012. Updated by MISP-2019.1. Retrieved 6 July 2020. Available at <http://www.gwg.nga.mil/misb/docs/misp/MISP-6.4.pdf>.

- **Intra-Packet Time Stamp.** These 8 bytes indicate the time tag of the individual TS packets. First long word (LSLW) bits 31-0 and second long word (MSLW) bits 31-0 indicate the following values.
 - (5) The 48-bit RTC that will correspond to the first bit of the TS. Bits 31 to 16 in the second long word (MSLW) will be zero filled; or
 - (6) The absolute time, if enabled by bit 6 in the packet flags (Subsection [11.2.1.1](#) item [g](#)). The time format is indicated by bits 2 and 3 in the packet flags (Subsection [11.2.1.1](#) item [g](#)). The time tag shall be correlated to the first bit of the TS.
- d. **Video Packet Data.** A Format 0 packet shall contain an integral number of 188-byte (1504 bits) TS packets as illustrated in [Figure 11-49](#) and [Figure 11-50](#) depending on the byte alignment bit. The IPHs can be inserted in Format 0 video data packets. The 10 MHz RTC packet header time is the time of the first bit of the first TS in the packet.

The CBR of the encoding will be user-selectable and within the MPEG-2 MP@ML and H.264 MP@L3 specification. Per ISO/IEC 13818-1:2007²⁰ the TS format will be fixed-length 188-byte (1504 bits) frames containing an 8-bit sync pattern or “sync byte” (starting at bit 0 and ending at bit 7 of the TS format). The sync bytes value is 01000111 (0x47). The rest of the TS 187 data bytes will follow ([Table 11-38](#)).

Table 11-38. Format 0 MPEG-2/H.264 Video Data Packet	
(Example is 16-Bit Aligned)	
msb	lsb
15	0
Packet Header	
Channel-Specific Data (Bits 15-0)	
Channel-Specific Data (Bits 31-16)	
(Optional) Intra-Packet Time Stamp	
TS Sync Byte Data (Bits 15 to 0)	
TS Data (Bits 31 to 16)	
:	
TS Data (Bits 1487 to 1472)	
TS Data (Bits 1503 to 1488)	
(Optional) Intra-Packet Time Stamp	
TS Sync Byte Data (Bits 15 to 0)	
TS Data (Bits 31 to 16)	
:	
TS Data (Bits 1487 to 1472)	
TS Data (Bits 1503 to 1488)	
:	
(Optional) Intra-Packet Time Stamp	

²⁰ ISO/IEC. *Information technology -- Generic coding of moving pictures and associated audio information: Systems*. ISO/IEC 13818-1:2007. October 2007. Updated by ISO/IEC 13818-1:2015. Retrieved 6 July 2020. Available for purchase at <https://www.iso.org/standard/62074.html>.

Repeat for each TS.
:
Packet Trailer

11.2.10.2 Video Packets, Format 1 (ISO 13818-1 MPEG-2 Bit Stream)

Unlike Video Packets, Format 0 (MPEG-2) the Format 1 packets encapsulate the complete ISO/IEC 13818-1:2007 bit streams for both program and transport with constant or variable bit rates. Also any of the profiles and level combinations as set forth by ISO/IEC 13818-1:2007 may be utilized in the encoding process. The TSs are limited to a single PS using PES packets that share the same common time base. A TS must contain the PAT and PMT that define the PID for the PCR stream. The PSs also must contain at least one packet header.

- a. MPEG-2 Stream Packet Body. The Format 1 packet within MPEG-2 packets has the basic structure shown in [Table 11-39](#). Note that the width of the structure is not related to any number of bits. This drawing is merely intended to represent relative placement of data in the packet.

Table 11-39. General MPEG-2 Video Packet, Format 1
Packet Header
Channel-Specific Data
(Optional) Intra-Packet Header
MPEG-2 Packet 1
(Optional) Intra-Packet Header
MPEG-2 Packet 2
:
(Optional) Intra-Packet Header
MPEG-2 Packet <i>n</i>
Packet Trailer

- b. Video Packet Audio. When recording video using Format 1, if audio is present, it will be inserted into the TS per ISO/IEC 13818-3. A separate analog channel to specifically record audio will not be required as MPEG-2 supports audio insertion into the TS or PS. By combining video and audio, recording bandwidth and memory capacity will be increased.
- c. MPEG-2 Channel-Specific Data Word. The packet body portion of each MPEG-2 bit stream begins with a CSDW formatted as shown in [Figure 11-52](#).

msb											lsb
31	22	21	20	19	18	15	14	13	12	11	0
RESERVED	KLV	SRS	IPH	EPL	ET	MD	TP	PC			

Figure 11-52. MPEG-2 Channel-Specific Data Word

- Reserved. Bits 31-22 are reserved for future use.
- KLV. Bit 21 indicates if KLV metadata is present in the MPEG-2 video data.

0 = No KLV metadata present

1 = KLV metadata is present.

MPEG-2 stream KLV metadata (if utilized) will be IAW MISP Standard 9711, Standard 9712, Standard 9713, Recommended Practice 9717, and Standard 0107.1.

- SCR/RTC Sync (SRS). Bit 20 indicates whether the MPEG-2 SCR is RTC.

0 = SCR is not synchronized with the 10 MHz RTC.

1 = SCR is synchronized with the 10 MHz RTC.

The TSs contain their own embedded time base used to facilitate the decoding and presentation of video and/or audio data at the decoder. Within a PS, all streams are synchronized to a single SCR. Within a TS, each embedded program contains its own PCR, requiring that each Format 1 encoded MPEG-2 TS contain only a single program allowing each format to be treated in a similar manner using a single global clocking reference.

The 10 MHz RTC is used to synchronize and time stamp the data acquired from multiple input sources. For input sources that don't define an explicit timing model for data presentation, superimposing this timing model can be accomplished. For MPEG-2, however, an explicit synchronization model based on a 27 MHz clock is defined for the capture, compression, decompression, and presentation of MPEG-2 data. In order to relate the two different timing models, the MPEG-2 SCR/PCR time stamps (if enabled) will be derived from the 10 MHz RTC timing reference source (by generating the 27 MHz MPEG-2 reference clock slaved to the 10 MHz RTC).

MPEG-2 defines the SCR/PCR time stamp as a 42-bit quantity, consisting of a 33-bit base value and a 9-bit extension value. The exact value is defined as:

$$\text{SCR} = \text{SCR_base} * 300 + \text{SCR_ext}$$

where:

$$\text{SCR_base} = ((\text{system_clock_frequency} * t) / 300) \text{ MOD } 233$$

$$\text{SCR_ext} = ((\text{system_clock_frequency} * t) / 1) \text{ MOD } 300$$

For recording periods of less than 26.5 hours, the SCR can be directly converted into the 10 MHz RTC using the equation:

$$10 \text{ MHz RTC time base} = \text{SCR} * 10/27 \text{ (rounded to the nearest integer)}$$

For recording periods longer than this, the Format 1 packet header time stamp can be used to determine the number of times the MPEG-2 SCR has rolled over and calculate the upper 8 bits of the free-running counter's value.

- Intra-Packet Header (IPH). Bit 19 indicates whether IPTSs are inserted before each program or transport packet.
- Encoding Profile and Level (EPL). Bits 18-15 indicate the MPEG-2 profile and level of the encoded bit stream.

0000 = Simple Profile @ Main Level

0001 = Main Profile @ Low Level

0010 = Main Profile @ Main Level
0011 = Main Profile @ High-1440 Level
0100 = Main Profile @ High Level
0101 = SNR Profile @ Low Level
0110 = SNR Profile @ Main Level
0111 = Spatial Profile @ High-1440 Level
1000 = High Profile @ Main Level
1001 = High Profile @ High-1440 Level
1010 = High Profile @ High Level
1011 = 4:2:2 Profile @ Main Level
1100 = Reserved
1101 = Reserved
1110 = Reserved
1111 = Reserved

- Embedded Time (ET). Bit 14 indicates whether embedded time is present in the MPEG-2 video data.

0 = No embedded time present
1 = Embedded time is present

MPEG-2 stream embedded time, if utilized, will be IAW MISP Standard 9708 and Standard 9715. Embedded time is used for the synchronization of core MPEG-2 data when extracted from the Chapter 10 domain (i.e., an export to MPEG-2 files).

- Mode (MD). Bit 13 indicates whether the MPEG-2 bit stream was encoded using a variable or CBR parameter setting.

0 = CBR stream
1 = Variable bit rate stream

- Type (TP). Bit 12 indicates the type of data the packetized MPEG-2 bit stream contains.

0 = Transport data bit stream
1 = Program data bit stream

- Packet Count (PC). Bits 11-0 indicate the binary value of the number of MPEG-2 packets included in the Format 1 packet.

An integral number of complete packets will be in each Format 1 packet. If the MPEG-2 hardware implementation is unable to determine the value of this number, the value of 0 is used by default. If TYPE = 0, then this number represents the number of TS packets within the Format 1 packet. If TYPE = 1, then this number represents the number of PS packs within the Format 1 packet.

- d. Intra-Packet Header. If enabled, the IPH shall include a 64-bit IPTS, which is inserted immediately before the MPEG-2 packet (transport or program). The length of the IPH is fixed at 64 bits (8 bytes) positioned contiguously, in the following sequence ([Figure 11-53](#)).

msb	lsb
31	0
Time (LSLW)	
Time (MSLW)	

Figure 11-53. Video Packet, Format 1 Intra-Packet Header

- **Intra-Packet Time Stamp.** These 8 bytes indicate the time tag of the individual MPEG-2 packets (transport or program). First long word (LSLW) bits 31-0 and second long word (MSLW) bits 31-0 indicate the following values.
 - The 48-bit RTC that will correspond to the first bit of the MPEG-2 packet (transport or program). Bits 31 to 16 in the second long word (MSLW) will be zero-filled; or
 - The absolute time, if enabled by bit 6 in the packet flags (Subsection [11.2.1.1](#) item g). Time format is indicated by bits 2 and 3 in the packet flags (Subsection [11.2.1.1](#) item g). The time tag shall be correlated to the first bit of the MPEG-2 packet (transport or program).

11.2.10.3 Video Packets, Format 2 (ISO 14496 MPEG-4 Part 10 AVC/H.264)

Format 2 video encoding will be IAW ISO 14496 Part 10.²¹ The carrier format for Format 2 AVC/H.264 will be ISO/IEC 13818-1:2007 bit streams for both program and transport with constant or variable bit rates. AVC/H.264 can be carried over the MPEG-2 streams IAW ITU-T Rec. H.222.0.

Unlike Format 0 video packets (MPEG-2/H.264), which only support a fixed MPEG-2 transport and fixed MPEG-2/H.264 profiles and levels, the Format 2 AVC/H.264 packets encapsulate the complete MPEG-2 TSs/PSs, provide for a fixed/variable bit rate (Format 1), and include all H.264 video encoding profiles and levels.

Format 2 AVC/H.264 streams are limited to a single program or TS using PES packets that share the same common time base. The TS or PS must contain the PAT and PMT that define the PID for the PCR stream. The PSs also must contain at least one packet header.

- a. **AVC/H.264 Stream Packet Body.** The Format 2 packet within AVC/H.264 packets has the basic structure shown in [Table 11-40](#). Note that the width of the structure is not related to any number of bits. This drawing is merely intended to represent relative placement of data in the packet.

Table 11-40. General AVC/H.264 Video Packet, Format 2
Packet Header
Channel-Specific Data
(Optional) Intra-Packet Header
AVC/H.264 Packet 1
(Optional) Intra-Packet Header

²¹ ISO/IEC. *Information Technology - Coding of Audio-Visual Objects - Part 10: Advanced Video Coding*. ISO/IEC 14496-10:2014. 1 September 2014. May be superseded by update. Retrieved 6 July 2020. Available at <http://standards.iso.org/ittf/PubliclyAvailableStandards/index.html>.

AVC/H.264 Packet 2
:
(Optional) Intra-Packet Header
AVC/H.264 Packet <i>n</i>
Packet Trailer

- b. Video Packet Audio. When recording video using Format 2 AVC/H.264, if audio is present it will be inserted into the TS per ISO/IEC 13818-3 or 13818-7.²² A separate analog channel to specifically record audio will not be required as AVC/H.264 supports audio insertion into the AVC/H.264 TS. By combining video and audio, recording bandwidth and memory capacity will be increased.
- c. AVC/H.264 Channel-Specific Data Word. The packet body portion of each AVC/H.264 packet begins with a CSDW formatted as shown in [Figure 11-54](#).

msb													lsb	
31	27	26	25	22	21	20	19	18	15	14	13	12	11	0
R	AET		EL	KLV		SRS	IPH	EP	ET	MD	TP	PC		

Figure 11-54. AVC/H.264 Channel-Specific Data Word

- Reserved (R). Bits 31-27 are reserved for future use.
- AVC/H.264 Audio Encoding Type (AET). Bit 26 indicates the AVC/H.264 audio encoding type.
 - 0 = ISO/IEC 13818-3
 - 1 = ISO/IEC 13818-7
- AVC/H.264 Encoding Level (EL). Bits 25-22 indicate the AVC/H.264 level of the encoded video bit stream.
 - 0000 = 1 0001 = 1b 0010 = 1.1 0011 = 1.2 0100 = 1.3
 - 0101 = 2 0110 = 2.1 0111 = 2.2 1000 = 3 1001 = 3.1
 - 1010 = 3.2 1011 = 4 1100 = 4.1 1101 = 4.2 1110 = 5
 - 1111 = 5.1
- KLV. Bit 21 indicates if KLV metadata is present in the MPEG-2 video data.
 - 0 = No KLV metadata present
 - 1 = KLV metadata is present

MPEG-2 stream KLV metadata (if utilized) will be IAW MISP Standard 9711, Standard 9712, Standard 9713, Recommended Practice 9717, and Standard 0107.1.
- SCR/RTC Sync (SRS). Bit 20 indicates whether the AVC/H.264 MPEG-2 SCR is RTC.
 - 0 = SCR is not synchronized with the 10 MHz RTC.

²² ISO/IEC. *Information technology -- Generic coding of moving pictures and associated audio information -- Part 7: Advanced Audio Coding (AAC)*. ISO/IEC 13818-7:2006(E). Geneva: International Organization for Standardization, 2006.

1 = SCR is synchronized with the 10 MHz RTC.

The TSs contain their own embedded time base used to facilitate the decoding and presentation of video and/or audio data at the decoder. Within a PS, all streams are synchronized to a single SCR. Within a TS, each embedded program contains its own PCR, requiring that each Format 0-encoded MPEG-2 TS contain only a single program allowing each format to be treated in a similar manner using a single global clocking reference.

The 10-MHz RTC is provided to synchronize and time stamp the data acquired from multiple input sources. For input sources that don't define an explicit timing model for data presentation, superimposing this timing model can be accomplished. For MPEG-2, however, an explicit synchronization model based on a 27 MHz clock is defined for the capture, compression, decompression, and presentation of MPEG-2 data. In order to relate the two different timing models, the MPEG-2 SCR/PCR time stamps (if enabled) will be derived from the 10 MHz RTC timing reference source (by generating the 27 MHz MPEG-2 reference clock slaved to the 10 MHz RTC).

MPEG-2 defines the SCR/PCR time stamp as a 42-bit quantity, consisting of a 33-bit base value and a 9-bit extension value. The exact value is defined as:

$$\text{SCR} = \text{SCR_base} * 300 + \text{SCR_ext}$$

where:

$$\text{SCR_base} = [(\text{system_clock_frequency} * t) / 300] \text{ MOD } 233$$

$$\text{SCR_ext} = [(\text{system_clock_frequency} * t) / 1] \text{ MOD } 300$$

For recording periods of less than 26.5 hours, the SCR can be directly converted into the 10 MHz RTC using this equation:

$$10 \text{ MHz RTC time base} = \text{SCR} * 10/27 \text{ (rounded to nearest integer).}$$

For recording periods longer than this, the Format 0 packet header time stamp can be used to determine the number of times the MPEG-2 SCR has rolled over and calculate the upper 8 bits of the free-running counter's value.

- Intra-Packet Header (IPH). Bit 19 indicates whether IPTSs are inserted before each program or transport packet.
- AVC/H.264 Encoding Profile (EP). Bits 18-15 indicate the AVC/H.264 profile of the encoded video bit stream.

0000 = Baseline Profile (BP)	0001 = Main Profile (MP)
0010 = Extended Profile (EP)	0011 = High Profile (HiP)
0100 = High 10 Profile (Hi10P)	0101 = High 4:2:2 Profile (Hi422P)
0110 = High 4:4:4 Profile (Hi444P)	0111 - 1111 = Reserved

- Embedded Time (ET). Bit 14 indicates whether embedded time is present in the AVC/H.264 MPEG-2 video data.

0 = No embedded time present
 1 = Embedded time is present

AVC/H.264 MPEG-2 stream embedded time (if utilized) will be IAW MISP Standard 9708 and Standard 9715. Embedded time is used for the synchronization of core AVC/H.264 data when extracted from the Chapter 10 domain, i.e., an export to AVC/H.264 files.

- **Mode (MD).** Bit 13 indicates whether the AVC/H.264 MPEG-2 bit stream was encoded using a variable or CBR parameter setting.
 - 0 = CBR stream
 - 1 = Variable bit rate stream
- **Type (TP).** Bit 12 indicates the type of data the packetized AVC/H.264 MPEG-2 bit stream contains.
 - 0 = Transport data bit stream
 - 1 = Program data bit stream
- **Packet Count (PC).** Bits 11-0 indicate the binary value of the number of AVC/H.264 packets included in the Format 2 packet.

An integral number of complete packets will be in each Format 2 packet. If the AVC/H.264 hardware implementation is unable to determine the value of this number, the value of 0 is used by default. If TYPE = 0, then this number represents the number of TS packets within the Format 2 packet. If TYPE = 1, then this number represents of the number of PS packets within the Format 2 packet.

- d. **Intra-Packet Header.** If enabled, the IPH shall include a 64-bit IPTS, which is inserted immediately before the AVC/H.264 packet (transport or program). The length of the IPH is fixed at 8 bytes (64 bits) positioned contiguously, in the following sequence ([Figure 11-55](#)).

msb	lsb
31	0
Time (LSLW)	
Time (MSLW)	

Figure 11-55. Video Packet, Format 2 Intra-Packet Header

- **Intra-Packet Time Stamp.** These 8 bytes indicate the time tag of the individual AVC/H.264 packets (transport or program). First long word (LSLW) bits 31-0 and second long word (MSLW) bits 31-0 indicate the following values.
 - The 48-bit RTC that will correspond to the first bit of the AVC/H.264 packet. Bits 31 to 16 in the second long word (MSLW) will be zero-filled; or
 - The absolute time, if enabled by bit 6 in the packet flags ([Subsection 11.2.1.1](#) item [g](#)). The time format is indicated by bits 2 and 3 in the packet flags ([Subsection 11.2.1.1](#) item [g](#)). The time tag shall be correlated to the first bit of the AVC/H.264 packet.

11.2.10.4 Video Packets, Format 3 (MJPEG)

Format 3 video encoding will be IAW ISO/IEC 10918 Part 1²³ used by Audio Video Interleaved, Motion JPEG Video. A set of images for this type with compatible parameters can be placed into an MJPEG video packet as shown in [Table 11-41](#). Frame headers shall be limited to those specified in ISO/IEC 10918 Part 1. These types are SOF0, SOF1, SOF2, SOF3, SOF9, SOF10, and SOF11. Of these types accommodated, this specification provides implementation only for baseline sequential discrete cosine transform.

Table 11-41. MJPEG Video Packet, Format 3	
msb	lsb
15	0
PACKET HEADER	
CHANNEL-SPECIFIC DATA (BITS 15-0)	
CHANNEL-SPECIFIC DATA (BITS 31-16)	
INTRA-PACKET HEADER FOR SEGMENT 1 (BITS 15-0)	
INTRA-PACKET HEADER FOR SEGMENT 1 (BITS 31-16)	
INTRA-PACKET HEADER FOR SEGMENT 1 (BITS 47-32)	
INTRA-PACKET HEADER FOR SEGMENT 1 (BITS 63-48)	
INTRA-PACKET HEADER FOR SEGMENT 1 (BITS 79-64)	
INTRA-PACKET HEADER FOR SEGMENT 1 (BITS 95-80)	
FRAME BYTE 2	FRAME BYTE 1
:	:
FILLER (IF n IS ODD)	FRAME BYTE n
:	
INTRA-PACKET HEADER FOR SEGMENT n (BITS 15-0)	
INTRA-PACKET HEADER FOR SEGMENT n (BITS 31-16)	
INTRA-PACKET HEADER FOR SEGMENT n (BITS 47-32)	
INTRA-PACKET HEADER FOR SEGMENT n (BITS 63-48)	
INTRA-PACKET HEADER FOR SEGMENT n (BITS 79-64)	
INTRA-PACKET HEADER FOR SEGMENT n (BITS 95-80)	
FRAME BYTE 2	FRAME BYTE 1
:	:
FILLER (IF n IS ODD)	FRAME BYTE n
PACKET TRAILER	

An MJPEG video packet shall contain one or more fixed-length segments of a partial MJPEG frame, one complete MJPEG frame, or multiple complete MJPEG frames.

MJPEG video packet information will be specified in the CSDW.

- a. MJPEG Video Packet Channel-Specific Data Word. The packet body portion of each MJPEG video packet begins with a CSDW. It indicates if the packet body contains several complete images or partial images ([Figure 11-56](#)).

²³ ISO/IEC. "General sequential and progressive syntax", Annex B, section B.2, in *Information technology -- Digital compression and coding of continuous-tone still images: Requirements and guidelines*. ISO/IEC 10918-1:1994. May be superseded by update. Geneva: International Organization for Standardization, 1994.

msb						lsb
31	30	29	28	27	26	0
PARTS		SUM		IPH	RESERVED	

Figure 11-56. MJPEG Video packet Channel-Specific Data Word

- Parts. Bits 31-30 indicate which segment of the frames is contained in the packet if the packet does not contain one or more complete frames.
 - 00 = Packet does not contain first or last segment of frame
 - 01 = Packet contains first segment of frame
 - 10 = Packet contains last segment of frame
 - 11 = Reserved
 - Sum. Bits 29-28 indicate if the packet contains a partial frame that spans multiple packets, one complete frame, or multiple complete frames.
 - 00 = Packet contains less than one complete frame (a segment)
 - 01 = Packet contains one complete frame
 - 10 = Packet contains multiple complete frames
 - 11 = Reserved
 - Intra-Packet Header (IPH). Bit 27 indicates that the IPH (time stamp/data) shall precede each complete frame within a packet or the first segment of a multi-segment frame. An IPH (time stamp) is not required for a frame segment if it is not the first segment of a frame.
 - 0 = Intra-Packet Header not enabled
 - 1 = Intra-Packet Header enabled
 - Reserved. Bits 26-0 are reserved.
- b. MJPEG Video Intra-Packet Header. After the CSDW, the format 3 MJPEG video data (complete frame, multiple complete frames, or frame segment) is inserted into the packet. The frame shall be preceded by an IPH, which shall provide the complete frame or first frame segment time stamp and the frame length. The IPH time stamp value indicates the time of the complete frame capture.

The IPH consists of an IPTS and intra-packet data. The length of the IPH is fixed at 12 bytes (96 bits) positioned contiguously, in the following sequence ([Figure 11-57](#)).

msb						lsb
31						0
TIME (LSLW)						
TIME (MSLW)						
FRAME LENGTH						

Figure 11-57. MJPEG Video Intra-Packet Header

- Intra-Packet Time Stamp (TIME). These 8 bytes indicate the time tag of the Format 3 MJPEG video data. First long word bits 31-0 and second long word bits 31-0 indicate the following values:

- The 48-bit RTC that corresponds to the first data bit in the MJPEG frame with bits 31 to 16 in the second long word zero filled or;
- The absolute time, if enabled by bit 6 in the packet flags (Subsection [11.2.1.1](#) item g). The time format is indicated by bits 2 and 3 in the packet flags (Subsection [11.2.1.1](#) item g). The time tag shall be correlated to the first data bit in the MJPEG frame.
- Intra-Packet Data (FRAME LENGTH). These 4 bytes indicate a binary value that represents the byte length of the following complete frame.

11.2.10.5 Video Packets, Format 4 (MJPEG-2000).

Format 4 video encoding will be IAW ISO/IEC 15444-3:2007 Motion JPEG 2000.²⁴ A set of images for this type with compatible parameters can be placed into an MJPEG-2000 video packet as shown in [Table 11-42](#).

Table 11-42. MJPEG Video Packet, Format 4	
msb 15	lsb 0
PACKET HEADER	
CHANNEL-SPECIFIC DATA (BITS 15-0)	
CHANNEL-SPECIFIC DATA (BITS 31-16)	
INTRA-PACKET HEADER FOR SEGMENT 1 (BITS 15-0)	
INTRA-PACKET HEADER FOR SEGMENT 1 (BITS 31-16)	
INTRA-PACKET HEADER FOR SEGMENT 1 (BITS 47-32)	
INTRA-PACKET HEADER FOR SEGMENT 1 (BITS 63-48)	
INTRA-PACKET HEADER FOR SEGMENT 1 (BITS 79-64)	
INTRA-PACKET HEADER FOR SEGMENT 1 (BITS 95-80)	
FRAME BYTE 2	FRAME BYTE 1
:	:
FILLER (IF <i>n</i> IS ODD)	FRAME BYTE <i>n</i>
:	
INTRA-PACKET HEADER FOR SEGMENT <i>n</i> (BITS 15-0)	
INTRA-PACKET HEADER FOR SEGMENT <i>n</i> (BITS 31-16)	
INTRA-PACKET HEADER FOR SEGMENT <i>n</i> (BITS 47-32)	
INTRA-PACKET HEADER FOR SEGMENT <i>n</i> (BITS 63-48)	
INTRA-PACKET HEADER FOR SEGMENT 1 (BITS 79-64)	
INTRA-PACKET HEADER FOR SEGMENT <i>n</i> (BITS 95-80)	
FRAME BYTE 2	FRAME BYTE 1
:	:
FILLER (IF <i>n</i> IS ODD)	FRAME BYTE <i>n</i>
PACKET TRAILER	

²⁴ ISO/IEC. *Information technology: JPEG 2000 image coding system: motion JPEG 2000*. ISO/IEC 15444-3:2007. Geneva: International Organization for Standardization, 2007.

An MJPEG-2000 video packet shall contain one or more fixed-length segments of a partial MJPEG-2000 frame, one complete MJPEG-2000 frame, or multiple complete MJPEG-2000 frames.

MJPEG-2000 video packet information will be specified in the CSDW.

- a. MJPEG-2000 Video Packet Channel-Specific Data Word. The packet body portion of each MJPEG-2000 video packet begins with a CSDW. It indicates if the packet body contains several complete images or partial images ([Figure 11-58](#)).

msb	lsb
31 30 29 28 27 26	0
PARTS	SUM
IPH	RESERVED

Figure 11-58. MJPEG 2000 Video Packet Channel-Specific Data Word

- Parts. Bits 31-30 indicate which segment of the frames is contained in the packet if the packet does not contain one or more complete frames.
 - 00 = Packet does not contain first or last segment of frame
 - 01 = Packet contains first segment of frame
 - 10 = Packet contains last segment of frame
 - 11 = Reserved
 - Sum. Bits 29-28 indicate if the packet contains a partial frame that spans multiple packets, one complete frame, or multiple complete frames.
 - 00 = Packet contains less than one complete frame (a segment)
 - 01 = Packet contains one complete frame
 - 10 = Packet contains multiple complete frame
 - 11 = Reserved
 - Intra-Packet Header (IPH). Bit 27 indicates that the IPH (time stamp/data) shall precede each complete frame within a packet or the first segment of a multi-segment frame. An IPH (time stamp) is not required for a frame segment if it is not the first segment of a frame.
 - 0 = Intra-Packet Header not enabled
 - 1 = Intra-Packet Header enabled
 - Reserved. Bits 26-0 are reserved.
- b. MJPEG Video Intra-Packet Header. After the CSDW, the format 4 MJPEG-2000 video data (complete frame, multiple complete frames, or frame segment) is inserted into the packet. The frame shall be preceded by an IPH, which shall provide the complete frame or first frame segment time stamp and the frame length. The IPH time stamp value indicates the time of the complete frame capture.

The IPH consists of an IPTS and intra-packet data. The length of the IPH is fixed at 12 bytes (96 bits) positioned contiguously, in the following sequence ([Figure 11-59](#)).

msb	lsb
31	0
TIME (LSLW)	
TIME (MSLW)	
FRAME LENGTH	

Figure 11-59. MJPEG Video Intra-Packet Header

- **Intra-Packet Time Stamp (TIME).** These 8 bytes indicate the time tag of the Format 4 MJPEG-2000 video data. First long word bits 31-0 and second long word bits 31-0 indicate the following values:
 - The 48-bit RTC that corresponds to the first data bit in the MJPEG-2000 frame with bits 31 to 16 in the second long word zero filled or;
 - The absolute time, if enabled by bit 6 in the packet flags (Subsection [11.2.1.1](#) item [g](#)). The time format is indicated by bits 2 and 3 in the packet flags (Subsection [11.2.1.1](#) item [g](#)). The time tag shall be correlated to the first data bit in the MJPEG-2000 frame.
- **Intra-Packet Data (FRAME LENGTH).** These 4 bytes indicate a binary value that represents the byte length of the following complete frame.

11.2.11 Image Packets

11.2.11.1 Image Packets, Format 0 (Image Data)

A Format 0 image packet ([Table 11-43](#)) shall contain one or more fixed-length segments of one or more video images. The CSDW for an image packet identifies the number of segments in the packet and the portion of the image or images contained in the packet. If the optional IPH is not included with each segment, the RTC in the packet header is the time of the first segment in the packet.

Table 11-43. Image Packet, Format 0	
msb	lsb
15	0
Packet Header	
Channel-Specific Data (Bits 15-0)	
Channel-Specific Data (Bits 31-16)	
Optional Intra-Packet Header for Segment 1 (Bits 15-0)	
Optional Intra-Packet Header for Segment 1 (Bits 31-16)	
Optional Intra-Packet Header for Segment 1 (Bits 47-32)	
Optional Intra-Packet Header for Segment 1 (Bits 63-48)	
Byte 2	Byte 1
:	:
Filler (if N is Odd)	Byte N
:	:
Optional Intra-Packet Header for Segment N (Bits 15-0)	
Optional Intra-Packet Header for Segment N (Bits 31-16)	

Optional Intra-Packet Header for Segment N (Bits 47-32)	
Optional Intra-Packet Header for Segment N (Bits 63-48)	
Byte 2	Byte 1
:	:
Filler (if N is Odd)	Byte N
Packet Trailer	

- a. Image Packet Channel-Specific Data Word. The packet body portion of each image packet begins with a CSDW. It defines the byte length of each segment and indicates if the packet body contains several complete images or partial images, and whether or not the IPDH precedes each segment ([Figure 11-60](#)).

msb						lsb
31	30	29	28	27	26	0
PARTS	SUM	IPH	LENGTH			

Figure 11-60. Image Packet Channel-Specific Data Word

- Parts. Bits 31-30 indicate which piece or pieces of the video frame are contained in the packet.
 - 00 = Packet does not contain first or last segment of image
 - 01 = Packet contains first segment of image
 - 10 = Packet contains last segment of image
 - 11 = Packet contains both first and last segment of image
 - Sum. Bits 29-28 indicate if the packet contains a partial image, one complete image, multiple complete images, or pieces from multiple images.
 - 00 = Packet contains less than one complete image
 - 01 = Packet contains one complete image
 - 10 = Packet contains multiple complete images
 - 11 = Packet contains multiple incomplete images
 - Intra-Packet Header (IPH). Bit 27 indicates whether the IPH (time stamp) precedes each segment of the image.
 - 0 = The IPH not enabled
 - 1 = The IPH enabled
 - Length. Bits 26-0 indicate a binary value that represents the byte length of each segment.
- b. Image Intra-Packet Header. After the channel-specific data, Format 0 image data is inserted into the packet. Each block of data is optionally preceded by an IPH as indicated by the IPH bit in the CSDW. When included, the IPH consists of an IPTS only. The length of the IPH is fixed at 8 bytes (64 bits) positioned contiguously, in the following sequence ([Figure 11-61](#)).

msb	lsb
31	0
Time (LSLW)	
Time (MSLW)	

Figure 11-61. Image Data Intra-Packet Header, Format 0

- **Intra-Packet Time Stamp.** These 8 bytes indicate the time tag of the Format 0 image data. First long word bits 31-0 and second long word bits 31-0 indicate the following values.
 - The 48-bit RTC that corresponds to the first data bit in the first byte with bits 31 to 16 in the second long word zero-filled; or
 - The absolute time, if enabled by bit 6 in the packet flags (Subsection [11.2.1.1](#) item g). The time format is indicated by bits 2 and 3 in the packet flags (Subsection [11.2.1.1](#) item g). The time tag shall be correlated to the first data bit in the image or segment.

11.2.11.2 Image Packets, Format 1 (Still Imagery)

A Format 1 image packet ([Table 11-44](#)) shall contain one or more fixed-length segments of a partial still image, one complete still image, or multiple still images. The still image source can be external or internal to the recorder. The still image formats will be specified in the CSDW and in the Computer-Generated Data, Format 1 setup record for each still imagery channel. Only one format can be contained within each channel ID for still imagery.

Table 11-44. Still Imagery Packet, Format 1	
msb	lsb
15	0
Packet Header	
Channel-Specific Data (Bits 15-0)	
Channel-Specific Data (Bits 31-16)	
Intra-Packet Header for Segment 1 (Bits 15-0)	
Intra-Packet Header for Segment 1 (Bits 31-16)	
Intra-Packet Header for Segment 1 (Bits 47-32)	
Intra-Packet Header for Segment 1 (Bits 63-48)	
Intra-Packet Header for Segment 1 (Bits 79-64)	
Intra-Packet Header for Segment 1 (Bits 95-80)	
Byte 2	Byte 1
:	:
Filler (if N is Odd)	Byte N
:	
Intra-Packet Header for Segment N (Bits 15-0)	
Intra-Packet Header for Segment N (Bits 31-16)	
Intra-Packet Header for Segment N (Bits 47-32)	
Intra-Packet Header for Segment N (Bits 63-48)	
Intra-Packet Header for Segment 1 (Bits 79-64)	

Intra-Packet Header for Segment N (Bits 95-80)	
Byte 2	Byte 1
:	:
Filler (if N is Odd)	Byte N
Packet Trailer	

- a. **Still Imagery Packet Channel-Specific Data Word.** The packet body portion of each still image packet begins with a CSDW. It defines the format of the still imagery format (which will coincide with the still imagery format with the setup record), and indicates if the packet body contains several complete images or partial images (Figure 11-62).

msb										lsb
31	30	29	28	27	26	23	22			0
PARTS		SUM		IPH	FORMAT		RESERVED			

Figure 11-62. Still Imagery Packet Channel-Specific Data Word

- **Parts.** Bits 31-30 indicate which piece or pieces of the image are contained in the packet.
 - 00 = Packet does not contain first or last segment of image
 - 01 = Packet contains first segment of image
 - 10 = Packet contains last segment of image
 - 11 = Packet contains both first and last segment of image
- **Sum.** Bits 29-28 indicate if the packet contains a partial image, one complete image, multiple complete images, or pieces from multiple images.
 - 00 = Packet contains less than one complete image
 - 01 = Packet contains one complete image
 - 10 = Packet contains multiple complete images
 - 11 = Packet contains multiple incomplete images
- **Intra-Packet Header (IPH).** Bit 27 indicates whether the IPH (time stamp) precedes each segment of the image.
 - 0= The IPH not enabled
 - 1= The IPH enabled
- **Format.** Bits 26-23 indicate a binary value that represents the still image format.
 - 0000 = MIL-STD-2500²⁵ National Imagery Transmission Format
 - 0001 = JPEG File Interchange Format
 - 0010 = JPEG 2000 (ISO/IEC 15444-1)²⁶
 - 0011 = Portable Network Graphics Format

²⁵ Department of Defense. "National Imagery Transmission Format Version 2.1." MIL-STD-2500C w/Change 2. 2 January 2019. May be superseded by update. Retrieved 6 July 2020. Available at https://quicksearch.dla.mil/qsDocDetails.aspx?ident_number=112606.

²⁶ ISO/IEC. *Information Technology -- JPEG 2000 Image Coding System: Core Coding System*. ISO/IEC 15444-1:2016. October 2016. Revised by ISO/IEC 15444:1-2019. Retrieved 6 July 2020. Revised version available for purchase at <https://www.iso.org/standard/78321.html>.

0100-1111= Reserved

- Reserved. Bits 22-0 are reserved.
- b. Still Imagery Intra-Packet Header. After the channel-specific data, Format 1 still imagery data is inserted into the packet. Each still image or segment is preceded by an IPH. The IPH consists of an IPTS and intra-packet data. The length of the IPH is fixed at 12 bytes (96 bits) positioned contiguously, in the following sequence ([Figure 11-63](#)).

msb	lsb
31	0
Time (LSLW)	
Time (MSLW)	
Intra-Packet Data	

Figure 11-63. Still Imagery Intra-Packet Header

- Intra-Packet Time Stamp. These 8 bytes indicate the time tag of the Format 1 still imagery data. First long word bits 31-0 and second long word bits 31-0 indicate the following values.
 - The 48-bit RTC that corresponds to the first data bit in the still image or segment with bits 31 to 16 in the second long word zero-filled; or
 - The absolute time, if enabled by bit 6 in the packet flags (Subsection [11.2.1.1](#) item [g](#)). The time format is indicated by bits 2 and 3 in the packet flags (Subsection [11.2.1.1](#) item [g](#)). The time tag shall be correlated to the first data bit in the still image or segment.
- Intra-Packet Data. These 4 bytes indicate a binary value that represents the byte length of the following still image or segment.

11.2.11.3 Image Packets, Format 2 (Dynamic Imagery).

A Format 2 image packet ([Table 11-45](#)) shall contain one or more fixed-length segments of a partial dynamic image, one complete dynamic image, or multiple complete dynamic images. Typically, dynamic image packets will be created from cameras attached to a recorder or cameras that include a recording capability.

Table 11-45. Dynamic Imagery Packet, Format 1	
msb	lsb
15	0
Packet Header	
Channel-Specific Data (Bits 15-0)	
Channel-Specific Data (Bits 31-16)	
Intra-Packet Header for Segment 1 (Bits 15-0)	
Intra-Packet Header for Segment 1 (Bits 31-16)	
Intra-Packet Header for Segment 1 (Bits 47-32)	
Intra-Packet Header for Segment 1 (Bits 63-48)	
Intra-Packet Header for Segment 1 (Bits 79-64)	

Intra-Packet Header for Segment 1 (Bits 95-80)	
Image Byte 2	Image Byte 1
:	:
Filler (if n is Odd)	Image Byte N
:	
Intra-Packet Header for Segment N (Bits 15-0)	
Intra-Packet Header for Segment N (Bits 31-16)	
Intra-Packet Header for Segment N (Bits 47-32)	
Intra-Packet Header for Segment N (Bits 63-48)	
Intra-Packet Header for Segment 1 (Bits 79-64)	
Intra-Packet Header for Segment N (Bits 95-80)	
Image Byte 2	Image Byte 1
:	:
Filler (if n is Odd)	Image Byte N
Packet Trailer	

Each source of dynamic imagery (camera or sensor) shall have its own individual channel ID value. Multiple sources of dynamic imagery (camera or sensor) shall not share the same channel ID value. Dynamic Imagery, Format 2 is defined as image data that has a rate as opposed to Format 1 still imagery, which does not.

Dynamic image information will be specified in the CSDW and in the Computer-Generated Data, Format 1 setup record for each dynamic imagery channel. Only one dynamic imagery format can be defined for each Format 2 image packet channel ID.

If changes are made to the initial dynamic imagery channel settings in the Computer-Generated Data, Format 1 setup record a new setup record packet shall be created prior to any Format 2 image packets to which the new settings are applied. These changes shall be noted as a setup record configuration change in the Computer-Generated Data, Format 1 setup record CSDW.

- a. Dynamic Imagery Packet Channel-Specific Data Word. The packet body portion of each dynamic image packet begins with a CSDW. It defines the format of the dynamic imagery format (which will coincide with the dynamic imagery format with the setup record) and indicates if the packet body contains several complete images or partial images ([Figure 11-64](#)).

msb										lsb																					
31	30	29	28	27	26	25	24	23	22	21	20	19	18	17	16	15	14	13	12	11	10	9	8	7	6	5	4	3	2	1	0
PARTS			SUM			IPH			FORMAT			RESERVED																			

Figure 11-64. Dynamic Imagery Packet Channel-Specific Data Word

- Parts. Bits 31-30 indicate which segment of the image is contained in the packet if the packet does not contain one or more complete images.
 - 00 = Packet does not contain first or last segment of image
 - 01 = Packet contains first segment of image
 - 10 = Packet contains last segment of image

11 = Reserved

- Sum. Bits 29-28 indicate if the packet contains a partial image that spans multiple packets, one complete image, or multiple complete images.

00 = Packet contains less than one complete image (a segment)

01 = Packet contains one complete image

10 = Packet contains multiple complete images

11 = Reserved

- Intra-Packet Header (IPH). Bit 27 indicates that the IPH (time stamp/data) shall precede each complete image within a packet or the first segment of a multi-segment image. The time stamp applied to each complete image or first segment of an image is dependent on the time stamp mode as defined in Subsection [11.2.11.3](#) item [b](#). An IPH (time stamp) is not required for an image segment if it is not the first segment of an image.

0= The IPH is not enabled

1= The IPH is enabled

- Format. Bits 26-21 indicate a binary value that represents the dynamic image pixel format IAW GenICam Standard Features Naming Convention v1.5²⁷ or later and GigE Vision v1.2²⁸ or later.

0x00 = Mono8

0x01 = Mono8Signed

0x02 = Mono10

0x03 = Mono10Packed

0x04 = Mono12

0x05 = Mono12Packed

0x06 = Mono14

0x07 = Mono16

0x08 = BayerGR8

0x09 = BayerRG8

0x0A = BayerGB8

0x0B = BayerBG8

0x0C = BayerGR10

0x0D = BayerRG10

0x0E = BayerGB10

0x0F = BayerBG10

0x10 = BayerGR12

0x11 = BayerRG12

0x12 = BayerGB12

0x13 = BayerBG12

0x14 = BayerGR10Packed

²⁷ European Machine Vision Association. *GenICam Standard Features Naming Convention*. Version 1.5. November 2011. Retrieved 6 July 2020. Available at http://www.emva.org/wp-content/uploads/GenICam_SFNC_1_5.pdf.

²⁸ Automated Imaging Association. *GigE Vision*. Version 1.2. n.d. Retrieved 6 July 2020. Available for download with registration at http://www.visiononline.org/form.cfm?form_id=735.

0x15 = BayerRG10Packed
0x16 = BayerGB10Packed
0x17 = BayerBG10Packed
0x18 = BayerGR12Packed
0x19 = BayerRG12Packed
0x1A = BayerGB12Packed
0x1B = BayerBG12Packed
0x1C = BayerGR16
0x1D = BayerRG16
0x1E = BayerGB16
0x1F = BayerBG16
0x20 = RGB8Packed
0x21 = BGR8Packed
0x22 = RGBA8Packed
0x23 = BGRA8Packed
0x24 = RGB10Packed
0x25 = BGR10Packed
0x26 = RGB12Packed
0x27 = BGR12Packed
0x28 = RGB16Packed
0x29 = BGR16Packed
0x2A = RGB10V1Packed
0x2B = BGR10V1Packed
0x2C = RGB10V2Packed
0x2D = BGR10V2Packed
0x2E = RGB12V1Packed
0x2F = RGB565Packed
0x30 = BGR565Packed
0x31 = YUV411Packed
0x32 = YUV422Packed
0x33 = YUV444Packed
0x34 = YUYVPacked
0x35 = RGB8Planar
0x36 = RGB10Planar
0x37 = RGB12Planar
0x38 = RGB16Planar
0x39-0x3E = Reserved
0x3F = Device-specific

- Reserved. Bits 20-0 are reserved.
- b. Dynamic Imagery Intra-Packet Header. After the CSDW, the Format 2 dynamic imagery data (complete image, multiple complete images, or image segment) is inserted into the packet. The image shall be preceded by an IPH; this IPH shall provide the complete image or first image segment time stamp and the image length. The IPH time stamp value indicates the time of the complete image at sensor/camera capture.

The image time stamp characteristics are further defined within the setup record dynamic imagery packet channel attributes. Due to the fact that dynamic imagery may be captured and then packetized post-capture there maybe uniqueness in regards to time stamping of the data versus packet header/secondary header values related to the first bit of data within the packet as defined in sections [11.2.1.1](#) item [i](#) and [11.2.1.2](#) item [a](#). Individual image IPH time stamp modes are defined as follows.

- (1) **Image Capture Time.** The IPH TIME value corresponds to the RTC or absolute time when the image was captured by the sensor/camera. The packet header RTC/packet secondary header values indicate when the first bit of data is placed into the packet. When Image Capture Time mode is indicated in the setup record it is understood there is a delay period between packet header RTC/secondary header time and IPH time.
- (2) **Image Packetization Time.** The IPH TIME value corresponds to the RTC or absolute time when the image was packetized. The packet header RTC/secondary header values indicate when the first bit of data is placed into the packet. Image packetization time is defined as packetizing image data as it is captured by the sensor/camera. When Image Packetization Time mode is indicated in the setup record it is understood there is not a delay period between packet header RTC/secondary header time and the image IPH time.

The IPH consists of an IPTS and intra-packet data. The length of the IPH is fixed at 12 bytes (96 bits) positioned contiguously, in the following sequence ([Figure 11-65](#)).

msb	lsb
31	0
Time (LSLW)	
Time (MSLW)	
Image Length	

Figure 11-65. Dynamic Imagery Intra-Packet Header

- **Intra-Packet Time Stamp (TIME).** These 8 bytes indicate the time tag of the Format 2 dynamic imagery data as defined in Section [11.2.11.3](#) item [b](#). First long word bits 31-0 and second long word bits 31-0 indicate the following values.
 - The 48-bit RTC that corresponds to the first data bit in the dynamic image with bits 31 to 16 in the second long word zero-filled; or
 - The absolute time, if enabled by bit 6 in the packet flags (Subsection [11.2.1.1](#) item [g](#)). The time format is indicated by bits 2 and 3 in the packet flags (Subsection [11.2.1.1](#) item [g](#)). The time tag shall be correlated to the first data bit in the dynamic image.
- **Intra-Packet Data (IMAGE LENGTH).** These 4 bytes indicate a binary value that represents the byte length of following complete image.

11.2.12 UART Data Packets

11.2.12.1 UART Data Packets, Format 0

The data from one or more separate asynchronous serial communication interface channels (RS-232, RS-422, RS-485, etc.) can be placed into a UART data packet as shown in [Table 11-46](#). Note that 9 bit UART data is not supported by this format.

Table 11-46. UART Data Packet Format	
msb	lsb
15	0
Packet Header	
Channel-Specific Data (Bits 15-0)	
Channel-Specific Data (Bits 31-16)	
(Optional) Intra-Packet Time Stamp for UART 1 (Bits 15-0)	
(Optional) Intra-Packet Time Stamp for UART 1 (Bits 31-16)	
(Optional) Intra-Packet Time Stamp for UART 1 (Bits 47-32)	
(Optional) Intra-Packet Time Stamp for UART 1 (Bits 63-48)	
Intra-Packet Data Header (UART ID) for UART 1 (Bits 15-0)	
Intra-Packet Data Header (UART ID) for UART 1 (Bits 31-16)	
Byte 2	Byte 1
:	:
Filler (if <i>n</i> is Odd)	Byte N
:	
(Optional) Intra-Packet Time Stamp for UART N (Bits 15-0)	
(Optional) Intra-Packet Time Stamp for UART N (Bits 31-16)	
(Optional) Intra-Packet Time Stamp for UART N (Bits 47-32)	
(Optional) Intra-Packet Time Stamp for UART N (Bits 63-48)	
Intra-Packet Data Header (UART ID) for UART N (Bits 15-0)	
Intra-Packet Data Header (UART ID) for UART N (Bits 31-16)	
Byte 2	Byte 1
:	:
Filler (if <i>n</i> is Odd)	Byte N
Packet Trailer	

- a. UART Packet Channel-Specific Data Word. The packet body portion of each UART data packet begins with a CSDW as shown in [Figure 11-66](#).

msb	lsb
31	0
30	0
IPH	RESERVED

Figure 11-66. UART Packet Channel-Specific Data Word

- Intra-Packet Header. Bit 31 indicates whether the IPH time stamp is inserted before the UART ID words.

0 = The IPH time stamp not enabled

1 = The IPH time stamp enabled

- Reserved. Bits 30-0 are reserved.
- b. UART Intra-Packet Header. After the channel-specific data, UART data is inserted into the packet. Each block of data shall be preceded by an IPH with optional IPTS and a mandatory UART ID word IPDH. The length of the IPH is either 4 bytes (32 bits) or 12 bytes (96 bits) positioned contiguously, in the following sequence ([Figure 11-67](#)).

msb	lsb
31	0
Time (LSLW)	
Time (MSLW)	
UART ID Word	

Figure 11-67. UART Data Intra-Packet Header

- UART Intra-Packet Time Stamp. These 8 bytes indicate the time tag of the UART data. First long word bits 31-0 and second long word bits 31-0 indicate the following values.
 - The 48-bit RTC that corresponds to the first data bit in the first byte with bits 31 to 16 in the second long word zero-filled; or
 - The absolute time, if enabled by bit 6 in the packet flags (Subsection [11.2.1.1](#) item [g](#)). The time format is indicated by bits 2 and 3 in the packet flags (Subsection [11.2.1.1](#) item [g](#)). The time tag shall be correlated to the first data bit in the message.
- UART Intra-Packet Data Header. The IPDH is a UART ID word that precedes the data and is inserted into the packet with the following format. Inclusion of the IPDH is mandatory and is not controlled by the IPH bit in the CSDW ([Figure 11-68](#)).

msb					lsb
31	30	29	16	15	0
PE	RESERVED	SUBCHANNEL	DATA LENGTH		

Figure 11-68. Intra-Packet Data Header Format

- Parity Error (PE). Bit 31 indicates a parity error.
 - 0 = No parity error
 - 1 = Parity error
- Reserved. Bit 30 is reserved.
- Subchannel. Bits 29-16 indicate a binary value defining the subchannel number belonging to the data that follows the UART ID word when the channel ID in the packet header defines a group of subchannels. Zero means first and/or only subchannel into which the IPDH is inserted before the UART ID words.
- Data Length. Bits 15-0 indicate a binary value representing the length of the UART data in bytes (*n*) that follows the UART ID word.

11.2.13 IEEE 1394 Data Packets

11.2.13.1 IEEE 1394 Data Packets, Format 0(IEEE 1394 Transaction)

This format applies to IEEE 1394 data as described by IEEE 1394-2008.²⁹ The IEEE 1394 data is packetized to encapsulate completed transactions between nodes. A packet may contain 0 to 65,536 transactions, but is constrained by the common packet element size limits prescribed in Subsection [11.2.1](#). The IEEE 1394 packets have the basic structure shown in [Table 11-47](#). Note that the width of the structure is not related to any number of bits. The table merely represents relative placement of data within the packet.

Table 11-47. IEEE 1394 Data Packet, Format 0	
Packet Header	
Channel-Specific Data Word	
(Optional) Intra-Packet Header	
(Optional) Transaction Data	
(Optional) Intra-Packet Header	
(Optional) Transaction Data	
:	
(Optional) Intra-Packet Header	
(Optional) Transaction Data	
Packet Trailer	

- a. IEEE 1394 Channel-Specific Data Word. The packet body portion ([Figure 11-69](#)) of each IEEE 1394 packet shall begin with a CSDW.

msb								lsb			
31	29	28	25	24	16	15	0				
PBT			SY		RESERVED			TC			

Figure 11-69. IEEE 1394 Channel-Specific Data Word

- Packet body Type (PBT). Bits 31-29 indicate the packet body type as follows:
 - 000 = Type 0
 - 001 = Type 1
 - 010 = Type 2
 - 011- 111= Reserved
- Synchronization Code (SY). Bits 28-25 indicate the IEEE 1394 synchronization code from the transaction. This field is mandatory for Type 1 packet bodies. Otherwise, it is reserved.
- Reserved. Bits 24-16 are reserved.
- Transaction Count (TC). Bits 15-0 indicate the binary value of the number of transactions encapsulated in the packet. An integral number of complete transactions

²⁹ Institute of Electrical and Electronics Engineers. *IEEE Standard for a High-Performance Serial Bus*. IEEE 1394-2008. New York: Institute of Electrical and Electronics Engineers, 2008.

shall be included in each packet. It is mandatory that transaction count be 0 for Type 0 packet bodies and 1 for Type 1 packet bodies.

- b. IEEE 1394 Intra-Packet Header. Each IPH shall contain an 8-byte IPTS only. The format of an IEEE 1394 IPH is described by [Figure 11-70](#).

msb	lsb
31	0
Intra-Packet Time Stamp	
Intra-Packet Time Stamp	

Figure 11-70. IEEE 1394 Intra-Packet Header

- IEEE 1394 Intra-Packet Time Stamp. These 8 bytes indicate the time tag of the IEEE 1394 transaction that immediately follows it in the packet. Time is coded IAW all other Chapter 11 packet formats. Specifically, the first long word bits 31-0 and second long word bits 31-0 indicate the following values.
 - The 48-bit RTC that corresponds to the first data bit of the transaction, with bits 31-16 in the second long word zero-filled; or
 - The absolute time, if enabled by bit 6 in the packet flags (Subsection [11.2.1.1](#) item [g](#)). The time format is indicated by bits 2 and 3 in the packet flags (Subsection [11.2.1.1](#) item [g](#)). The time tag shall be correlated to the first data bit of the transaction.
- c. IEEE 1394 Data Packet Body Types. Three packet body types are defined for the encapsulation of IEEE 1394 data. Regardless of type, each packet body shall begin with the IEEE 1394 packet CSDW as described by Subsection [11.2.13.1](#) item [a](#) above. The packet body type is indicated within the CSDW. Depending on the packet body type, the CSDW is followed by 0 or more transactions. In addition, dependent on packet body type, each transaction may be preceded by an IPH.

- IEEE 1394 Packet Body Type 0: Bus Status. Type 0 packet bodies shall contain zero IPHs and zero transactions. The CSDW transaction count shall be zero. The packet body shall contain the CSDW immediately followed by a single 32-bit word.

Bus status events shall be encapsulated by Type 0 packet bodies. The 32-bit word in the packet body shall contain an event data word as indicated in [Figure 11-71](#).

msb	lsb
31	0
30	0
RE	RESERVED

Figure 11-71. IEEE 1394 Event Data Word

- RESET (RE). Bit 31, when set, indicates that an IEEE 1394 bus reset has occurred.
- RESERVED. Bits 30-0 are reserved.
- IEEE 1394 Packet Body Type 1: Data streaming. Type 1 packet bodies shall encapsulate IEEE 1394 data streaming only. Type 1 packet body data is restricted to that from an IEEE 1394 packet with a transaction code of 0xA, be it from an

isochronous channel or asynchronous stream. The packet body shall contain zero IPHs and one transaction. The CSDW transaction count shall be one.

The CSDW is immediately followed by a non-zero number of data bytes. The data bytes shall be exactly those of a single IEEE 1394 data block, excluding the IEEE 1394 packet header and data block CRC. Data recorded from the stream shall be known to be valid, insofar as both the IEEE 1394 header CRC and data block CRC tests have passed. The number of data bytes shall be exactly four less than the value indicated in data length IAW the definition of packet header data length and accounting for the size of the CSDW. Conversely, the value stored in the packet header data length shall be the number of bytes in the IEEE 1394 data block plus four. The synchronization code (SY) from the stream packet shall be indicated in the CSDW, and the channel number shall be indicated in the packet header channel ID.

- **IEEE 1394 Packet Body Type 2: General-Purpose.** Type 2 packet bodies encapsulate complete IEEE 1394 packets, including header and data. Use of Type 2 packet bodies is unrestricted and may encapsulate streaming, non-streaming (IEEE 1394 packets with transaction codes other than 0xA), isochronous, and asynchronous data. Multiple IEEE 1394 packets, with differing transaction codes and channel numbers, may be carried within a single Type 2 packet body.

The CSDW shall be followed by a non-zero number of completed transactions as indicated by the CSDW transaction count. Each transaction shall be preceded by an IPH as defined above for IEEE 1394 data packets. Immediately following the IPH, the transaction shall be recorded in its entirety and must be a properly formed IEEE 1394 packet IAW the specification in use. The revision of the specification used shall be declared within the accompanying setup record packet.

 <p>NOTE</p>	<p>All IEEE 1394 packets contain a 4-bit Transaction Code field (tcode). This field indicates the IEEE 1394 specific format of the transaction.</p>
--------------------------------------------------------------------------------------------------------	-----------------------------------------------------------------------------------------------------------------------------------------------------

11.2.13.2 IEEE 1394 Data Packets, Format 1 (IEEE 1394 Physical Layer).

This format applies to IEEE 1394 data as described by IEEE 1394-1995, IEEE 1394a, and IEEE 1394b. The IEEE 1394 data is packetized in Format 1 packets as physical layer data transfers (IAW Annex J of Standard 1394-1995³⁰ and Chapter 17 of Standard 1394b-2002³¹). A packet may contain 0 to 65,536 transfers, but is constrained by the common packet element size limits prescribed in Subsection [11.2.1](#). The IEEE 1394 packets have the basic structure shown in [Table 11-48](#) below. Note that the width of the structure is not related to any number of bits. The drawing merely represents relative placement of data within the packet.

³⁰ Institute of Electrical and Electronics Engineers. *IEEE Standard for a High Performance Serial Bus*. IEEE 1394-1995. New York: Institute of Electrical and Electronics Engineers, 1995.

³¹ Institute of Electrical and Electronics Engineers. *IEEE Standard for a High Performance Serial Bus: Amendment 2*. IEEE 1394b-2002. New York: Institute of Electrical and Electronics Engineers, 2002.

Table 11-48. IEEE 1394 Data Packet, Format 1	
Packet Header	
Channel-Specific Data Word	
Intra-Packet Header	
Data	
(Optional) Intra-Packet Header	
(Optional) Data	
:	
(Optional) Intra-Packet Header	
(Optional) Data	
Packet Trailer	

- a. IEEE 1394 Channel-Specific Data Word. The packet body portion ([Figure 11-72](#)) of each IEEE 1394 packet shall begin with a CSDW.

msb		lsb
31	16 15	0
RESERVED	IPC	

Figure 11-72. IEEE 1394 Channel-Specific Data Word, Format 1

- Reserved. Bits 31-16 are reserved.
 - Intra-Packet Count (IPC). Bits 15-0 indicate the binary value of the number of intra-packets encapsulated in the Chapter 11 packet. An integral number of complete intra-packets shall be included in each Chapter 11 packet.
- b. IEEE 1394 Format 1 Intra-Packet Header. The CSDW is followed by 1 or more IEEE 1394 transfers. Each transfer starts with an IPH, followed by 0-32,780 encapsulated data bytes. The length of the IPH is fixed at 12 bytes (96 bits) positioned contiguously, in the following sequence as shown in [Figure 11-73](#).

msb	lsb
31	0
Intra-Packet Time Stamp	
Intra-Packet Time Stamp	
Intra-Packet ID Word	

Figure 11-73. IEEE 1394 Format 1 Intra-Packet Header

- IEEE 1394 Format 1 Intra-Packet Time Stamp. These 8 bytes indicate the time tag of the IEEE 1394 transfer that immediately follows it in the packet. Time is coded IAW all other Chapter 11 packet formats. Specifically, the first long word bits 31-0 and second long word bits 31-0 indicate the following values.
 - The 48-bit RTC that corresponds to the first data byte of the transfer, with bits 15-0 in the second long word zero-filled; or
 - The absolute time, if enabled by bit 6 in the packet flags (Subsection [11.2.1.1](#) item [g](#)). The time format is indicated by bits 2 and 3 in the packet flags

(Subsection [11.2.1.1](#) item g). The time tag shall be correlated to the first data byte of the transfer.

- Message ID Word. These 4 bytes are an ID word that precedes the message and is inserted into the packet as in [Figure 11-74](#).

msb	lsb
31	0
24	15
23	16
20	17
19	18
18	19
17	20
16	23
15	24
0	31
STATUS BYTE	SPEED
TRFOVF	LBO
RSV	DATA LENGTH

Figure 11-74. Intra-Packet Data Header - Message ID Word

- Status Byte. Bits 31-24 define the status byte received from the physical layer devices IAW IEEE 1394b specification.
- Transmission Speed (SPEED). Bits 23-20 identify the speed of transmission of the message. (Speed codes IAW IEEE 1394b)

0000 = S100 A

0001 = S100 B

0010 = S200 A

0011 = S200 B

0100 = S400 A

0101 = S400 B

0111 = S800 B

1001 = S1600 B

1010 = S3200 B

Other values are reserved

- Transfer Overflow Error (TRFOVF). Bits 19-18 indicate if a transfer synchronization error occurred.
 - 00 = IEEE 1394 flow did not exceed maximum intra-packet size.
 - 01 = This IEEE 1394 transfer started correctly but longer than the standard transfer length.
 - 10 = The previous IEEE 1394 transfer was in 01-type overflow and this IEEE 1394 transfer ended correctly (did not exceed standard transfer length).
 - 11 = The previous IEEE 1394 transfer was in 01-type overflow and this IEEE 1394 transfer did not end correctly (exceeds standard transfer length).

Most of the time, this field shall be 00. Possible combinations are: 01 intra-packet, zero or more; 11 intra-packet; and finally 10 intra-packet.

- Local Buffer Overflow (LBO). Bit 17, if set, indicates that some messages are lost before this transfer due to local buffer overflow.
- Reserved (RSV). Bit 16 is reserved.
- Data Length. Bits 15-0 contain a binary value that represents the length of the transfer in bytes (*n*) that follows the ID word. The maximum length of a

captured data is 4120 for transfers corresponding to asynchronous packets and 32,780 for transfers corresponding to isochronous packets.

If the data length field is not a multiple of 4 bytes, 1-3 fill bytes of 0x00 are added to maintain the packet structures in 32-bit boundary.

If the data length field contains 0, the intra-packet data is not provided and this word contains only the status byte information.

- c. **IEEE 1394 Format 1 Packet Body.** The packet body shall encapsulate IEEE 1394 isochronous or asynchronous message data. The data bytes shall be exactly those of a single IEEE 1394 physical transmission message, including the IEEE 1394 packet header and data block CRC. The data length field shall indicate the exact number of total bytes encapsulated in the message data.

11.2.14 Parallel Data Packet

11.2.14.1 Parallel Data Packet, Format 0

Parallel data packets are designed to record data from parallel interfaces (2-128 bit wide) including the industry de facto standard 8-bit Digital Cartridge Recording System – Incremental (DCRsi) interface. A single packet can hold data words or special data structures as currently defined for the DCRsi scan format. The exact format selection is defined in the CSDW. The data recorded from a parallel interface shall be placed into a Parallel Data Packet, Format 0 as shown in [Table 11-49](#).

Table 11-49. Parallel Data Packet, Format 0	
msb	lsb
15	0
Packet Header	
Channel-Specific Data (Bits 15-0)	
Channel-Specific Data (Bits 31-16)	
Data Word 1	
:	
Data Word <i>n</i>	
Packet Trailer	

- a. **Parallel Packet Channel-Specific Data Word.** The packet body portion of each parallel data packet begins with a CSDW. The CSDW is formatted as shown in [Figure 11-75](#).

msb	lsb
31	0
24	23
TYPE	RESERVED (0) OR SCAN NUMBER

Figure 11-75. Parallel Packet Channel-Specific Data Word

- **Type.** Bits 31-24 indicate the data type stored.
 - 0x01 - 0x00: Reserved
 - 0x80 - 0x02: Number of bits of recorded data (parallel data word width in bits)
 - 0xFD - 0x81: Reserved

0xFE: DCRsi scan format, contains auxiliary data, DCRsi main data
 0xFF: Reserved

- Scan Number. Bits 23-0 are reserved (0) for general-purpose parallel data packets or contain the scan number of the first scan stored in the packet for DCRsi data.
- b. General-Purpose Parallel Data. General-purpose parallel data packets can contain any number of data bytes, as indicated in the data length field in the packet headers ([Figure 11-76](#)).

msb		lsb	
15		0	
Pad	Data Word 2	Pad	Data Word 1
:		:	
Pad	Data Word <i>n</i> , or Pad if Length is Odd	Pad	Data Word N-1

Figure 11-76. Parallel Data, Up to 8-Bit-Wide Words

 <p>NOTE</p>	<p>To get the number of data words stored in the packet, the data length must be divided by the number of bytes necessary to hold one parallel data word.</p>
------------------------------------------------------------------------------------------------------	---------------------------------------------------------------------------------------------------------------------------------------------------------------

- If the number of data bits is 8 or less, the word shall be padded with zeros to 8-bit bytes.
- If the number of data bits is between 9 and 16, the words shall be padded with zeros to one 16-bit word, as in [Figure 11-77](#).

msb		lsb	
15		0	
Pad	Data Word 1		
:			
Pad	Data Word N		

Figure 11-77. Parallel Data, 9-Bit to 16-Bit-Wide Words

- If the number of data bits is greater than 16, the words shall be padded with zeros to multiples of 16-bit data words. [Figure 11-78](#) shows storing of 28-bit data words.

msb		lsb	
15		0	
Data Word 1, lsbs 15-0			
Pad	Data Word 1, msbs 27-16		
:			
Data Word N, lsbs 15-0			
Pad	Data Word N, msbs 27-16		

Figure 11-78. Parallel Data (Example: 28-Bit-Wide Words)

- c. DCRsi Parallel Data Packets. The DCRsi data packets can contain any number of complete DCRsi scans, containing 9 auxiliary data and 4356 main data bytes. The

number of the scans can be calculated from the data length field of the packet header. The structure of one DCRsi scan is in [Figure 11-79](#).

msb 15	lsb 0
Auxiliary Data 2	Auxiliary Data 1
Pad (0)	Auxiliary Data 3
Auxiliary Data 5	Auxiliary Data 4
Pad (0)	Auxiliary Data 6
Auxiliary Data 8	Auxiliary Data 7
Pad (0)	Auxiliary Data 9
Data Byte 2	Data Byte 1
Data Byte 4	Data Byte 3
:	:
Data Byte 4356	Data Byte 4355

Figure 11-79. DCRsi Scan, 9-Auxiliary Data Byte + 4326 Bytes

The length of the packet can be only $N * (12 + 4356) + 4$ bytes, including the length of the CSDW.

Any DCRsi data without auxiliary data bytes can be stored also as 8-bit general-purpose parallel data as described in Subsection [11.2.14](#) item [b](#).

11.2.15 Ethernet Data Packets

11.2.15.1 Ethernet Data Packets, Format 0

Data from one or more Ethernet network interfaces can be placed into an Ethernet Data Packet Format 0 as shown in [Table 11-50](#).

Table 11-50. Ethernet Data Packet, Format 0	
msb 15	lsb 0
Packet Header	
Channel-Specific Data (Bits 15-0)	
Channel-Specific Data (Bits 31-16)	
Intra-Packet Time Stamp for Msg 1 (Bits 15-0)	
Intra-Packet Time Stamp for Msg 1 (Bits 31-16)	
Intra-Packet Time Stamp for Msg 1 (Bits 47-32)	
Intra-Packet Time Stamp for Msg 1 (Bits 63-48)	
Intra-Packet Data Header for Msg 1 (Bits 15-0)	
Intra-Packet Data Header for Msg 1 (Bits 31-16)	
Byte 2	Byte 1
:	:
Filler (if n is Odd)	Byte n
:	:
Intra-Packet Time Stamp for Msg n (Bits 15-0)	

Intra-Packet Time Stamp for Msg <i>n</i> (Bits 31-16)	
Intra-Packet Time Stamp for Msg <i>n</i> (Bits 47-32)	
Intra-Packet Time Stamp for Msg <i>n</i> (Bits 63-48)	
Intra-Packet Data Header for Msg <i>n</i> (Bits 15-0)	
Intra-Packet Data Header for Msg <i>n</i> (Bits 31-16)	
Byte 2	Byte 1
:	:
Filler (if <i>n</i> is Odd)	Byte <i>n</i>
Packet Trailer	

- a. Ethernet Data Packet Format 0, Channel-Specific Data Word. The packet body portion of each Ethernet data packet begins with a CSDW. It indicates the format of the Ethernet data packet contents, applicable TTBs, and how many media access control (MAC) frames are placed in the packet body. The CSDW is formatted for the complete type of packet body as shown in [Figure 11-80](#).

msb										lsb									
31				28 27 25 24				16 15				0							
FORMAT				TTB				RESERVED				NUMBER OF FRAMES							

Figure 11-80. Ethernet Data Packet Format 0 Channel-Specific Data Word

- Format. Bits 31-28 indicate the type of Ethernet packet.
 - 0000 = Ethernet physical layer IEEE 802.3 MAC Frame
 - 0001-1111 = Reserved
 - Time Tag Bits (TTB). Bits 27-25 indicate which bit of the Ethernet MAC frame the IPH time tag is applicable to.
 - 000 = First bit of the MAC frame MAC destination address
 - 001 = Last bit of the MAC frame check sequence
 - 010 = First bit of the MAC frame payload data
 - 011 = Last bit of the MAC frame payload data
 - 100-111 = Reserved
 - Reserved. Bits 24-16 are reserved.
 - Number of Frames. Bits 15-0 contain a binary value that represents the number of frames included in the packet.
- b. Ethernet Data Packet Format 0, Intra-Packet Header. After the channel-specific data, Ethernet data is inserted into the packet. Each frame is preceded by an IPH that has both an IPTS and an IPDH containing a frame ID word. The length of the IPH is fixed at 12 bytes (96 bits) positioned contiguously, in the following sequence as shown in [Figure 11-81](#).

msb	lsb
31	0
Time (LSLW)	
Time (MSLW)	
Frame ID Word	

Figure 11-81. Ethernet Data Format 0 Intra-Packet Header

- **Intra-Packet Time Stamp.** These 8 bytes indicate the time tag of the frame data. First long word bits 31-0 and second long word bits 31-0 indicate the following values.
 - The 48-bit RTC that corresponds to the TTBs in the CSDW of the frame with bits 31 to 16 in the second long word zero-filled; or
 - The absolute time, if enabled by bit 6 in the packet flags (Subsection [11.2.1.1](#) item g). The time format is indicated by bits 2 and 3 in the packet flags (Subsection [11.2.1.1](#) item g). The time tag shall be correlated to the data bit indicated in the TTBs in the CSDW of the frame.
- **Frame ID Word.** The frame ID word is an identification word that precedes the Ethernet frame and is inserted into the packet with the format shown in [Figure 11-82](#).

msb												lsb
31	30	29	28	27	24	23	16	15	14	13		0
FCE	FE	CONTENT	SPEED	NET ID	DCE	LE	DATA LENGTH					

Figure 11-82. Intra-Packet Frame ID Word

- **Frame CRC Error (FCE).** Bit 31, the frame CRC error bit, is used to indicate that a MAC frame CRC error occurred during frame transmission.
 - 0 = No frame CRC error
 - 1 = Frame CRC error encountered
- **Frame Error (FE).** Bit 30, the frame error bit, is used to indicate any error that occurred during frame transmission.
 - 0 = No frame error
 - 1 = Frame error encountered
- **Captured Data Content (CONTENT).** Bits 29-28 specify the extent of the captured MAC frame.
 - 00 = Full MAC frame: starting with the 6-byte destination MAC address and ending with the 4-byte frame check sequence.
 - 01 = Payload (data) only: starting at the 14th byte offset from the beginning of the destination MAC address and ending before the 4-byte frame check sequence of the MAC frame.
 - 10 = Reserved for future format.
 - 11 = Reserved for future format.
- **Ethernet Speed (SPEED).** Bits 27-24 indicate the negotiated bit rate for the identified NETID on which the frame was captured.
 - 0000 = Auto

- 0001 = 10 megabits per second (Mbps)
- 0010 = 100 Mbps
- 0011 = 1 gigabit per second (Gbps)
- 0100 = 10 Gbps
- 0101 - 1111 = Reserved

- Network Identifier (NETID). Bits 23-16 contain a binary value that represents the physical network identification of frame origination that follows the ID word. Zero means first and/or only physical network.
- Data CRC Error (DCE). Bit 15, the data CRC error bit, is used to indicate that a CRC error exists in the payload of the frame.
 - 0 = No data CRC error
 - 1 = Data CRC error encountered
- Data Length Error (LE). Bit 14, the data length error bit, is used to indicate that the frame is too short (less than 64 bytes) or too long (longer than 1518 bytes).
 - 0 = Valid length
 - 1 = Data length ID too short or too long.
- Data Length. Bits 13-0 contain a binary value that represents the length of the frame in bytes (*n*) that follows the ID word.

11.2.15.2 Ethernet Data Packets, Format 1, ARINC-664

Any User Datagram Protocol (UDP) packets from Ethernet and/or ARINC-664 Part 7 (referred to as “ARINC-664” in this standard) network interfaces can be placed into an Ethernet Data Packet Format 1 as shown in [Table 11-51](#).

Table 11-51. Ethernet Data Format 1	
msb	lsb
15	0
Packet Header	
Channel-Specific Data (Bits 15-0)	
Channel-Specific Data (Bits 31-16)	
Intra-Packet Time Stamp for Msg 1 (Bits 15-0)	
Intra-Packet Time Stamp for Msg 1 (Bits 31-16)	
Intra-Packet Time Stamp for Msg 1 (Bits 47-32)	
Intra-Packet Time Stamp for Msg 1 (Bits 63-48)	
Intra-Packet Data Header for Msg 1 (Bits 15-0)	
Intra-Packet Data Header for Msg 1 (Bits 31-16)	
Intra-Packet Data Header for Msg 1 (Bits 47-32)	
Intra-Packet Data Header for Msg 1 (Bits 63-48)	
Intra-Packet Data Header for Msg 1 (Bits 79-64)	
Intra-Packet Data Header for Msg 1 (Bits 95-80)	
Intra-Packet Data Header for Msg 1 (Bits 111-96)	
Intra-Packet Data Header for Msg 1 (Bits 127-112)	

Byte 2	Byte 1
:	:
Filler (if <i>n</i> is Odd)	Byte N
:	
Intra-Packet Time Stamp for Msg N (Bits 15-0)	
Intra-Packet Time Stamp for Msg N (Bits 31-16)	
Intra-Packet Time Stamp for Msg N (Bits 47-32)	
Intra-Packet Time Stamp for Msg N (Bits 63-48)	
Intra-Packet Data Header for Msg N (Bits 15-0)	
:	
Intra-Packet Data Header for Msg N (Bits 127-112)	
Byte 2	Byte 1
:	:
Filler (if <i>n</i> is Odd)	Byte N
Packet Trailer	

The ARINC-664 is based on the Ethernet specification, IEEE Standard 802.3-2012.³² Unlike the Ethernet frame, the last byte of a frame payload is used for the frame sequence number. This byte is located just before the MAC CRC field, as part of the MAC payload. Ethernet Data Packets, Format 1 ARINC-664 shall capture and store the entire ARINC-664 message (the entire UDP payload), including one or more fragmented frames.

The ARINC-664 frame sequence numbers are used by the end system for integrity checking and redundancy management. ARINC-664 requires two redundant switch networks. Each ARINC-664 frame is replicated and sent on both networks. The ARINC-664 receiving end system uses the sequence number to check for dropped frames and to eliminate redundant frames. The link layer of the receiver’s ARINC-664 interface discards the sequence number and drops the redundant frame before passing the frame’s payload to the Internet Protocol (IP) network layer of the protocol stack. If a UDP datagram is fragmented, the sequence numbers on the fragments are discarded prior to datagram reassembly. [Table 11-52](#) compares a normal Ethernet frame with an ARINC-664 frame.

Table 11-52. Comparison of Normal Ethernet and ARINC-664 Frames						
Normal Ethernet Frame						
7 bytes	1 byte	14 bytes	20 bytes	8 bytes	≤ 1472 bytes	4 bytes
Preamble	Start Delimiter	MAC Header	IP Header	UDP Header	UDP Payload	FCS
ARINC-664 Frame						
7 bytes	1 byte	14 bytes	20 bytes	8 bytes	≤ 1471 bytes	1 byte
						4 bytes

³² Institute of Electrical and Electronics Engineers. *IEEE Standard for Ethernet*. IEEE 802.3-2012. New York: Institute of Electrical and Electronics Engineers.

Preamble	Start Delimiter	MAC Header	IP Header	UDP Header	ARINC- 664 Payload	Sequence Number	FCS
----------	--------------------	---------------	--------------	---------------	--------------------------	--------------------	-----

- a. Ethernet Data Format 1, Channel-Specific Data Word. The packet body portion of each Ethernet data packet begins with a CSDW. It indicates how many ARINC-664 messages are placed in the packet body. The CSDW is formatted for the complete type of packet body as shown in [Figure 11-83](#).

msb		lsb
31	16 15	0
Intra-Packet Header Length		Number of ARINC-664 Messages

Figure 11-83. Ethernet Data Packet Format 1 Channel-Specific Data Word

- Intra-Packet Header Length. Bits 31-16 contain the length of the IPH in bytes; this is fixed at 28.
 - Number of Messages. Bits 15-0 contain a binary value that represents the number of messages included in the packet.
- b. Ethernet Data Packet Format 1 Intra-Packet Header. After the channel-specific data, ARINC-664 data is inserted into the packet. Each message is preceded by an IPH that has both an IPTS and an IPDH. The length of the IPH is fixed at 28 bytes (224 bits) positioned contiguously, in the following sequence as shown in [Figure 11-84](#).

msb	lsb
31	0
Time (LSLW)	
Time (MSLW)	
Intra-Packet Data Header 1	
Intra-Packet Data Header 2	
Intra-Packet Data Header 3	
Intra-Packet Data Header 4	
Intra-Packet Data Header 5	

Figure 11-84. Ethernet Data Format 1 Intra-Packet Header

- Intra-Packet Time Stamp. These 8 bytes indicate the time tag of the ARINC-664 message. First long word bits 31-0 and second long word bits 31-0 indicate the following values.
 - The 48-bit RTC that corresponds to the first data bit in the frame with bits 31 to 16 in the second long word zero-filled; or
 - The absolute time, if enabled by bit 6 in the packet flags (Subsection [11.2.1.1](#) item [g](#)). The time format is indicated by bits 2 and 3 in the packet flags (Subsection [11.2.1.1](#) item [g](#)). The time tag shall be correlated to the first data bit in the frame.

- Intra-Packet Data Header. These 20 bytes contain ARINC-664 message data length, virtual link, source and destination IP addresses, and source and destination UDP ports, as shown in [Figure 11-85](#).

msb					lsb
31		16	15	8	7
					0
Data Length		Error bits		Flags bits	
Reserved		Virtual Link			
Source IP					
Dest IP					
Src Port			Dest Port		

Figure 11-85. Intra-Packet Data Header

- Data Length (bits 31-16)
Message length in bytes
- ERROR Bits (bits 15-8)
0: No errors
1: Any undefined error
2-15: Reserved
- Flags (bits 7-0)
0: Actual ARINC-664 data
1: Simulation ARINC-664 data
2-15: Reserved
- Reserved (bits 31-16)
- Virtual Link (VL) (bits 15-0)
Lower 16 bits of the Ethernet destination MAC address
- Source IP address (bits 31-0)
Source IP address from ARINC-664 IP header
- Dest IP Address (bits 31-0)
Destination IP address from ARINC-664 IP header
- Src Port (bits 31-16)
16 bits source port from the ARINC-664 UDP header
- Dest Port (bits 15-0)
Destination port from the ARINC-664 UDP header

11.2.16 Time Space Position Information and Combat Training Systems Data Packets

The Time Space Position Information (TSPI) and Combat Training Systems (CTS) data type packets are provided to allow a defined method of TSPI/CTS data encapsulation in Chapter 11 packet format. This will provide interoperability of these data sets between ranges and users along with alignment to other digital data in the recording, such as video and audio.

The TSPI/CTS data packets do not require a specific input interface such as PCM, analog, or MIL-STD-1553. The TSPI/CTS data type will only encapsulate multiple types of TSPI/CTS information IAW governing standards and specifications. Essentially, TSPI/CTS data will be wrapped in its native format by Chapter 11 packet structures and reside on compliant media devices and/or within files. The packet definition will not characterize transmission protocols or requirements because those are provided by the governing standards or specifications.

The TSPI/CTS packets are considered dynamic and timing requirements (e.g., of [Chapter 10](#)) apply whether they are generated by the recorder/multiplexer, like computer-generated data packets, or generated via a specific external interface.

11.2.16.1 TSPI/CTS Data Packets, Format 0 (NMEA-RTCM)

Any GPS data as defined by the National Marine Electronics Association (NMEA) and Radio Technical Commission for Maritime Services (RTCM) standards will be encapsulated in the Format 0 packet. The NMEA and RTCM standards specify the electrical signal requirements, data transmission protocol, and message/sentence formats for GPS data. These formatting standards will not be detailed in this chapter, but they will be referenced as required for clarity.

The TSPI/CTS Data Packet, Format 0 (NMEA-RTCM) will not support proprietary messages or sentences; therefore, any data containing these will be considered non-compliant with this standard.

A packet with n NMEA-RTCM data has the basic structure as [Table 11-53](#).

Table 11-53. NMEA-RTCM Data Packet Format	
msb	lsb
15	0
Packet Header	
Channel-Specific Data (Bits 15-0)	
Channel-Specific Data (Bits 31-16)	
(Optional) Intra-Packet Time Stamp for Data 1 (Bits 15-0)	
(Optional) Intra-Packet Time Stamp for Data 1 (Bits 31-16)	
(Optional) Intra-Packet Time Stamp for Data 1 (Bits 47-32)	
(Optional) Intra-Packet Time Stamp for Data 1 (Bits 63-48)	
Intra-Packet Data Header (Bits 15-0)	
Intra-Packet Data Header (Bits 31-16)	
Byte 2	Byte 1
:	:
Filler (if n is Odd)	Byte N
:	
(Optional) Intra-Packet Time Stamp for Data N (Bits 15-0)	
(Optional) Intra-Packet Time Stamp for Data N (Bits 31-16)	
(Optional) Intra-Packet Time Stamp for Data N (Bits 47-32)	
(Optional) Intra-Packet Time Stamp for Data N (Bits 63-48)	
Intra-Packet Data Header (Bits 15-0)	
Intra-Packet Data Header (Bits 31-16)	

Byte 2	Byte 1
:	:
Filler (if <i>n</i> is Odd)	Byte N
Packet Trailer	

- a. NMEA-RTCM Packet Channel-Specific Data Word. The packet body portion of each NMEA-RTCM data packet begins with a CSDW as shown in [Figure 11-86](#).

msb			lsb		
31	30	27	26	0	
IPTS	TYPE	RESERVED			

Figure 11-86. NMEA-RTCM Packet Channel-Specific Data Word

- IPTS. Bit 31 indicates whether the IPTS is enabled.
 - 0 = IPTS not enabled
 - 1 = IPTS enabled
 - TYPE. Bits 30-27 indicate the type of data NMEA-RTCM contains within the packet.
 - 0000 = NMEA 0183
 - 0001 = NMEA 0183-HS
 - 0010 = NMEA 2000
 - 0011 = RTCM SC104
 - 0010 - 1111 = Reserved
 - RESERVED. Bits 26-0 are reserved and shall be zero-filled.
- b. NMEA-RTCM Intra-Packet Time Stamp. If enabled the optional IPTS is inserted before each NMEA-RTCM message. The length of the IPTS is 8 bytes (64 bits) positioned contiguously, in the following sequence ([Figure 11-87](#)).

msb		lsb	
31		0	
(Optional) Time (LSLW)			
(Optional) Time (MSLW)			

Figure 11-87. NMEA-RTCM Intra-Packet Time Stamp

- Intra-Packet Time Stamp. These 8 bytes indicate the time tag of the NMEA-RTCM data. First long word bits 31-0 and second long word bits 31-0 indicate the following values.
 - The 48-bit RTC that corresponds to the first data bit. Bits 31 to 16 in the second long word (MSLW) will be zero-filled; or
 - The absolute time, if enabled by bit 6 in the packet flags (Subsection [11.2.1.1](#) item [g](#)). The time format is indicated by bits 2 and 3 in the packet flags (Subsection [11.2.1.1](#) item [g](#)). The time tag shall be correlated to the first data bit.

- c. NMEA-RTCM Intra-Packet Data Header. The length of the IPDH is fixed at 4 bytes (32 bits) positioned contiguously, in the following sequence ([Figure 11-88](#)).

msb		lsb
31	16 15	0
RESERVED	LENGTH	

Figure 11-88. NMEA-RTCM Intra-Packet Data Header

- RESERVED. Bits 31-16 are reserved.
- LENGTH. Bits 15-0 indicate the length of the message in bytes.

11.2.16.2 TSPI Data Packets, Format 1 (EAG ACMI)

Air Combat Maneuvering Instrumentation (ACMI) data as defined by the European Air Group (EAG) interface control document (ICD) DF29125³³ for post-mission interoperability will be encapsulated in the Format 1 packet. The EAG ACMI ICD defines the data contents and organization. Electrical signal requirements and data transmission protocol are not defined in DF29125 or in this Chapter 11 format. The data type will be 8-bit ASCII. A packet of EAG ACMI data has the basic structure of [Table 11-54](#).

Table 11-54. EAG ACMI Data Packet Format	
msb	lsb
15	0
Packet Header	
Channel-Specific Data (Bits 15-0)	
Channel-Specific Data (Bits 31-16)	
(Optional) Intra-Packet Time Stamp-Data Block 1 (Bits 15-0)	
(Optional) Intra-Packet Time Stamp-Data Block 1 (Bits 31-16)	
(Optional) Intra-Packet Time Stamp-Data Block 1 (Bits 47-32)	
(Optional) Intra-Packet Time Stamp-Data Block 1 (Bits 63-48)	
Intra-Packet Data Header	
(Optional) Static Data	
Byte 2	Byte 1
:	:
Filler (if <i>n</i> is Odd)	Byte N
Packet Trailer	

- a. EAG ACMI Packet Channel-Specific Data Word. The packet body portion of each EAG ACMI data packet begins with a CSDW as shown in [Figure 11-89](#).

³³ European Air Group. “European Air Group Interface Control Document for Post Mission Interoperability.” DF29125 Draft A Issue 01. July 2004. Retrieved 6 July 2020. Available to RCC members with Private Portal access at https://wsdmext.wsmr.army.mil/site/rccpri/Limited_Distribution_References/DF29125.pdf.

msb			lsb		
31	30	29	28	0	
IPTS		CONTENT		RESERVED	

Figure 11-89. EAG ACMI Packet Channel-Specific Data Word

- **IPTS.** Bit 31 indicates whether the IPTS is enabled.
 - 0 = IPTS not enabled
 - 1 = IPTS enabled
 - **CONTENT.** Bits 30-29 indicate the content of the EAG ACMI data within the packet.
 - 00 = TSPI data only (no static data or pod ID)
 - 01 = Contains pod ID and static data
 - 10 - 11 = Reserved
 - **RESERVED.** Bits 28-0 are reserved.
- b. **EAG ACMI Intra-Packet Time Stamp.** If enabled the optional IPTS is inserted before the EAG ACMI data block. The length of the IPTS is 8 bytes (64 bits) positioned contiguously, in the following sequence ([Figure 11-90](#)).

msb			lsb		
31					0
(Optional) Time (LSLW)					
(Optional) Time (MSLW)					

Figure 11-90. EAG ACMI Data Intra-Packet Time Stamp

- **EAG ACMI Intra-Packet Time Stamp.** These 8 bytes indicate the time tag of the EAG ACMI TSPI data. Pod ID and static data will not be time-tagged but will precede the TSPI data in the packet. First long word bits 31-0 and second long word bits 31-0 indicate the following values.
 - The 48-bit RTC that corresponds to the first TSPI data bit. Bits 31 to 16 in the second long word (MSLW) of the IPTS will be zero-filled; or
 - The absolute time, if enabled by bit 6 in the packet flags (Subsection [11.2.1.1](#) item [g](#)). The time format is indicated by bits 2 and 3 in the packet flags (Subsection [11.2.1.1](#) item [g](#)). The time tag shall be correlated to the first data bit.
- c. **EAG ACMI Intra-Packet Data Header.** The length of the IPDH is fixed at 4 bytes (32 bits) positioned contiguously, in the following sequence ([Figure 11-91](#)).

msb			lsb		
31	16 15				0
RESERVED			LENGTH		

Figure 11-91. EAG ACMI Intra-Packet Data Header

- **RESERVED.** Bits 31-16 are reserved.
- **LENGTH.** Bits 15-0 indicate the length of the message in bytes.

11.2.16.3 TSPI Data Packets, Format 2 (ACTTS)

Air Combat Test and Training System (ACTTS) data as defined by the USAF ACTTS interface specification WMSP 98-01³⁴ will be encapsulated in the Format 2 packet. The ACTTS interface specification defines the unique signal interface requirements for the air-to-air, air-to-ground, ground-to-air data links, and aircraft information subsystem recording formats. The ACTTS WMSP 98-01 establishes the requirements for the information recorded on the different data transfer units used by the various ACTTS airborne subsystems to support both tethered and rangeless operations.

When encapsulating ACTTS message/word format, data messages or words will not span packets. Each new packet will start with a full message and not a partial message or word. A packet of ACTTS data has the basic structure of [Table 11-55](#).

Table 11-55. ACTTS Data Packet Format	
msb	lsb
15	0
Packet Header	
Channel-Specific Data (Bits 15-0)	
Channel-Specific Data (Bits 31-16)	
(Optional) Intra-Packet Time Stamp for Data 1 (Bits 15-0)	
(Optional) Intra-Packet Time Stamp for Data 1 (Bits 31-16)	
(Optional) Intra-Packet Time Stamp for Data 1 (Bits 47-32)	
(Optional) Intra-Packet Time Stamp for Data 1 (Bits 63-48)	
Intra-Packet Data Header	
Byte 2	Byte 1
:	:
Filler (if <i>n</i> is Odd)	Byte N
:	:
(Optional) Intra-Packet Time Stamp for Data N (Bits 15-0)	
(Optional) Intra-Packet Time Stamp for Data N (Bits 31-16)	
(Optional) Intra-Packet Time Stamp for Data N (Bits 47-32)	
(Optional) Intra-Packet Time Stamp for Data N (Bits 63-48)	
Intra-Packet Data Header	
Byte 2	Byte 1
:	:
Filler (if <i>n</i> is Odd)	Byte N
Packet Trailer	

- a. ACTTS Packet Channel-Specific Data Word. The packet body portion of each ACTTS data packet begins with a CSDW as shown in [Figure 11-92](#).

³⁴ Range Instrumentation System Program Office, Air Armament Center. "Interface Specification for the USAF Air Combat Test and Training System (ACTTS) Air-to-Ground, Air-to-Air, Ground-to-Air Data Links, and AIS Recording Formats." WMSP 98-01, Rev A, Chg 1. 19 May 2003. Retrieved 6 July 2020. Available to RCC members with Private Portal access at https://wsdmext.wsmr.army.mil/site/rccpri/Limited_Distribution_References/WMSP_98-01.doc.

msb			lsb		
31	30	27	26	0	
IPTS	FORMAT	RESERVED			

Figure 11-92. ACTTS Packet Channel-Specific Data Word

- **IPTS.** Bit 31 indicates whether the IPTS is enabled.
 - 0 = IPTS not enabled
 - 1 = IPTS enabled
 - **FORMAT.** Bits 30-27 indicate the ACTTS format type of data contained within the packet.
 - 0000 = Kadena Interim Training System (KITS) Recording Formats
 - 0001 = Alpena KITS Recording Formats
 - 0010 = USAF Europe Rangeless Interim Training System Recording Formats
 - 0011 = Alaska ACTS Upgrade Recording Formats
 - 0100 = Goldwater Range Mission and Debriefing System Recording Formats
 - 0101 = P4RC Recording Formats
 - 0110 = Nellis ACTS Range Security Initiative Recording Formats
 - 0111 = P4RC+P5 CTS Participant Subsystem Recording Formats
 - 1000 = P5 CTS Recording Formats
 - 1001 - 1111 = Reserved
 - **RESERVED.** Bits 26-0 are reserved.
- b. **ACTTS Intra-Packet Time Stamp.** If enabled the optional IPTS is inserted before each ACTTS message. The length of the IPTS is 8 bytes (64 bits) positioned contiguously, in the following sequence ([Figure 11-93](#)).

msb			lsb		
31					0
(Optional) Time (LSLW)					
(Optional) Time (MSLW)					

Figure 11-93. ACTTS Data Intra-Packet Time Stamp

These 8 bytes indicate the time tag of the ACTTS data. First long word bits 31-0 and second long word bits 31-0 indicate the following values.

- The 48-bit RTC that corresponds to the first ACTTS data bit. Bits 31 to 16 in the second long word (MSLW) of the IPTS will be zero-filled; or
 - The absolute time, if enabled by bit 6 in the packet flags (Subsection [11.2.1.1](#) item [g](#)). The time format is indicated by bits 2 and 3 in the packet flags (Subsection [11.2.1.1](#) item [g](#)). The time tag shall be correlated to the first data bit.
- c. **ACTTS Intra-Packet Data Header.** The length of the IPDH is fixed at 4 bytes (32 bits) positioned contiguously, in the following sequence ([Figure 11-94](#)).

msb		lsb
31	16 15	0
RESERVED	LENGTH	

Figure 11-94. ACTTS Data Intra-Packet Data Header

- **RESERVED.** Bits 31-16 are reserved.
- **LENGTH.** Bits 15-0 indicate the length of the message in bytes.

11.2.17 Controller Area Network Bus Packets

11.2.17.1 Controller Area Network Bus Data Packet, Format 0

Data from one or more controller area network (CAN) bus interfaces are placed into a CAN bus data packet format as shown in [Table 11-56](#).

Table 11-56. Controller Area Network Bus Data Packet, Format 0	
msb	lsb
15	0
Packet Header	
Channel-Specific Data (Bits 15-0)	
Channel-Specific Data (Bits 31-16)	
Intra-Packet Time Stamp for Msg 1 (Bits 15-0)	
Intra-Packet Time Stamp for Msg 1 (Bits 31-16)	
Intra-Packet Time Stamp for Msg 1 (Bits 47-32)	
Intra-Packet Time Stamp for Msg 1 (Bits 63-48)	
Intra-Packet Message Header for Msg 1 (Bits 15-0)	
Intra-Packet Message Header for Msg 1 (Bits 31-16)	
Intra-Packet ID Word for Msg 1 (Bits 47-32)	
Intra-Packet ID Word for Msg 1 (Bits 63-48)	
Msg 1 Byte 2	Msg 1 Byte 1
:	:
Filler (if <i>n</i> is Odd)	Msg 1 Byte <i>n</i>
:	
Intra-Packet Time Stamp for Msg <i>n</i> (Bits 15-0)	
Intra-Packet Time Stamp for Msg <i>n</i> (Bits 31-16)	
Intra-Packet Time Stamp for Msg <i>n</i> (Bits 47-32)	
Intra-Packet Time Stamp for Msg <i>n</i> (Bits 63-48)	
Intra-Packet Message Header for Msg <i>n</i> (Bits 15-0)	
Intra-Packet Message Header for Msg <i>n</i> (Bits 31-16)	
Intra-Packet ID Word for Msg <i>n</i> (Bits 47-32)	
Intra-Packet ID Word for Msg <i>n</i> (Bits 63-48)	
Msg <i>n</i> Byte 2	Msg <i>n</i> Byte 1
:	:
Filler (if <i>m</i> is odd)	Msg <i>n</i> Byte <i>m</i>
Packet Trailer	

- a. **CAN Bus Packet Channel-Specific Data Word.** The packet body portion of each CAN bus data packet begins with a CSDW. [Figure 11-95](#) displays a complete CAN bus CSDW.

msb							lsb
31			16	15			0
RESERVED				N of Messages			

Figure 11-95. Complete CAN Bus Format 0 Channel-Specific Data Word

- **Reserved.** Bits 31-16 are reserved.
 - **N of Messages.** Bits 15-0 contain a binary value indicating the number of messages included in the packet.
- b. **CAN Bus Data Intra-Packet Header.** After the CSDW, CAN bus data is inserted into the packet. Each CAN bus message is preceded by an IPH that has both an IPTS and an intra-packet message header (IPMH) and an intra-packet ID word. The length of the IPH is fixed at 16 bytes (128 bits) positioned contiguously, in the sequence shown in [Figure 11-96](#).

msb							lsb
31							0
Intra-Packet Time Stamp (LSLW)							
Intra-Packet Time Stamp (MSLW)							
Intra-Packet Message Header							
Intra-Packet ID Word							

Figure 11-96. CAN Bus Data Format 0 Intra-Packet Data Header

- **Intra-Packet Time Stamp.** These 8 bytes indicate the time tag of the message data. First long word bits 31-0 and second long word bits 31-0 indicate the following values.
 - The RTC that corresponds to the first data bit in the message with bits 31 to 16 in the second long word zero-filled; or
 - Time, if enabled by bit 7 in the packet flags. Time format is indicated by bits 2 and 3 in the packet flags and to the first data bit in the message.
- **Intra-Packet Message Header.** The IPMH is an information word that is inserted into the packet with the format shown in [Figure 11-97](#).

msb											lsb
31	30	29	24	23		16	15		4	3	0
DE	FE	Reserved	SUBCHANNEL			Reserved	MESSAGE LENGTH				

Figure 11-97. Intra-Packet Message Header

- **Data Error (DE).** Bit 31 indicates bad data bits as determined by parity, checksums, or CRC words received with the data.
 - 0 = No data error has occurred

1 = Data error has occurred

- Format Error (FE). Bit 30 indicates a protocol error, such as out-of-sequence data or length errors.

0 = No format error

1 = Format error encountered

- Reserved. Bits 29-24 are reserved.
- Subchannel. Bits 23-16 contain a binary value that represents the subchannel number belonging to the message that follows the ID word when the channel ID in the packet header defines a group of subchannels. Zero means first and/or only subchannel, which is valid for the CAN bus.
- Reserved. Bits 15-4 are reserved.
- Message Length. Bits 3-0 contain a binary value representing the length of the number of the valid bytes in the rest of the message that follows the IPMH. The message length will be 4-12 bytes (4 bytes for the intra-packet ID word + 0-8 bytes data content of the CAN bus message).

- Intra-Packet ID Word. The intra-packet ID word contains the CAN bus message ID word transmitted on the bus. This word precedes the message and is inserted into the packet with the format shown in [Figure 11-98](#).

msb				lsb
31	30	29	28	0
IDE	RTR	Res	CAN Bus ID	

Figure 11-98. Intra-Packet ID Word

- IDE (bit 31 of the 32-bit CAN ID word): use extended CAN identifier.
 - 0 = 11-bit standard CAN identifier (CAN ID word bits 10-0)
 - 1 = 29-bit extended CAN identifier (CAN ID word bits 28-0)
- RTR (bit 30 of the CAN ID word): Remote transfer request bit.
- CAN Bus ID: The CAN bus ID transmitted in the message.

When using the 11-bit standard CAN identifier, bits 29-11 of the 32-bit CAN ID word are unused. For the 29-bit extended CAN identifier all the 29 bits, 28-0, are used.

- CAN Bus Message. The CAN bus message is placed behind the CAN bus IPH. The message can consist up to 8 bytes, which is placed in 0-4 x 16-bit data words. [Figure 11-99](#) displays a CAN bus message format.

BYTE 2	BYTE 1
:	:
Filler (if <i>n</i> is Odd)	BYTE <i>n</i>

Figure 11-99. CAN Bus Format 0 Message

11.2.17.2 Controller Area Network Bus Data Packet, Format 1

This section is reserved for future development

11.2.18 Fibre Channel Packets

11.2.18.1 Fibre Channel Data Packets, Format 0 (FC-PH Layer)

Data from a Fibre Channel port can be placed into a Fibre Channel Data Packet Format 0 as shown in [Table 11-57](#).

Table 11-57. Fibre Channel Data Packet, Format 0	
msb	0
15	
PACKET HEADER	
CHANNEL-SPECIFIC DATA (BITS 15-0)	
CHANNEL-SPECIFIC DATA (BITS 31-16)	
INTRA-PACKET HEADER FOR FIBRE CHANNEL FRAME 1 (BITS 15-0)	
INTRA-PACKET HEADER FOR FIBRE CHANNEL FRAME 1 (BITS 31-16)	
INTRA-PACKET HEADER FOR FIBRE CHANNEL FRAME 1 (BITS 47-32)	
INTRA-PACKET HEADER FOR FIBRE CHANNEL FRAME 1 (BITS 63-48)	
INTRA-PACKET HEADER FOR FIBRE CHANNEL FRAME 1 (BITS 79-64)	
INTRA-PACKET HEADER FOR FIBRE CHANNEL FRAME 1 (BITS 95-80)	
FRAME BYTE 2	FRAME BYTE 1
:	:
FILLER (IF n IS ODD)	FRAME BYTE n
:	
INTRA-PACKET HEADER FOR FIBRE CHANNEL FRAME n (BITS 15-0)	
INTRA-PACKET HEADER FOR FIBRE CHANNEL FRAME n (BITS 31-16)	
INTRA-PACKET HEADER FOR FIBRE CHANNEL FRAME n (BITS 47-32)	
INTRA-PACKET HEADER FOR FIBRE CHANNEL FRAME n (BITS 63-48)	
INTRA-PACKET HEADER FOR FIBRE CHANNEL FRAME n (BITS 79-64)	
INTRA-PACKET HEADER FOR FIBRE CHANNEL FRAME n (BITS 95-80)	
FRAME BYTE 2	FRAME BYTE 1
:	:
FILLER (IF n IS ODD)	FRAME BYTE n
PACKET TRAILER	

- a. Fibre Channel Data Packet Channel-Specific Data Word. The packet body portion of each Fibre Channel data packet begins with a CSDW. It indicates the format and how many Fibre Channel frames are placed in the packet body. The CSDW is formatted for the complete type of packet body as shown in [Figure 11-100](#).

msb						lsb
31	28	27		16	15	0
FORMAT	RESERVED				NUMBER OF FRAMES	

Figure 11-100. Fibre Channel Data Packet Channel-Specific Data Word

- Format. Bits 31-28 indicate the type of Fibre Channel data packet.
 - 0000 = FC-PH physical layer ANSI X3T11 Project 755-D
 - 0001 - 1111 = Reserved
 - Reserved. Bits 27-16 are reserved.
 - Number of Frames. Bits 15-0 contain a binary value that represents the number of complete or stripped Fibre Channel frames included in the packet.
- b. Fibre Channel Data Packet Format 0 Intra-Packet Header. After the channel-specific data, complete or stripped Fibre Channel frames are inserted into the packet. Each complete or stripped Fibre Channel frame is preceded by an IPH that has both an IPTS and an IPDH containing a frame ID word. The length of the IPH is fixed at 12 bytes (96 bits) positioned contiguously, in the following sequence as shown in [Figure 11-101](#).

msb	lsb
31	0
TIME (LSLW)	
TIME (MSLW)	
FRAME ID WORD	

Figure 11-101. Fibre Channel Data Format 0 Intra-Packet Header

- Intra-Packet Time Stamp. These 8 bytes indicate the time tag of the complete or stripped Fibre Channel frame. First long word bits 31-0 and second long word bits 31-0 indicate the following values:
 - The 48-bit RTC that corresponds to the first bit after the CSDW of the complete or stripped Fibre Channel frame with bits 31 to 16 in the second long word zero filled; or
 - The absolute time, if enabled by bit 6 in the packet flags (Subsection [11.2.1.1](#) item [g](#)). The time format is indicated by bits 2 and 3 in the packet flags (Subsection [11.2.1.1](#) item [g](#)). The time tag shall be correlated to the first data bit of the complete or stripped Fibre Channel frame.
- Frame ID Word. The frame ID word is an identification word that precedes the Fibre Channel frame and is inserted into the packet with the format shown in [Figure 11-102](#).

msb													lsb		
31	30	29	28	27	26	25	24	23	19	18	16	15	12	11	0
FE	CE	OE	SM	C		TOP		RSVD		EOF		SOF		FL	

Figure 11-102. Fibre Channel Data Format 0 Intra-Packet Frame ID Word

- Framing Error (FE). Bit 31 indicates a framing error such as EOF missing.
 - 0 = No framing error.
 - 1 = Framing error detected in Fibre Channel frame.
- CRC Error (CE). Bit 30 indicates a CRC error.
 - 0 = No CRC error.

- 1 = CRC error detected in Fibre Channel frame.
- Overrun Error (OE). Bit 29 indicates a buffer overrun error.
 - 0 = No overrun error.
 - 1 = Overrun error detected prior to this Fibre Channel frame.
- Stripped Mode (SM). Bit 28 indicates whether the Fibre Channel frame delimiters, header, and CRC are removed, resulting in a stripped Fibre Channel frame with data payload only.
 - 0 = Stripped mode. Only Fibre Channel data payload is present.
 - 1 = Non-stripped mode. Complete Fibre Channel frame is present.
- Content (CONTENT). Bits 27-26 specify the type of the Fibre Channel frame. Content bits are only valid when in non-stripped mode (i.e., bit 28 = 1).
 - 00 = Complete data frame
 - 01 = Complete link control frame
 - 10-11 = Reserved
- Topology (TOP). Bits 25-24 specify the Fibre Channel topology of frame from the port.
 - 00 = Passive
 - 01 – 11 Reserved
- Reserved. Bits 23-19 are reserved.
- End of Frame (EOF). Bits 18-16 indicate a binary value for the end-of-frame delimiter that terminated the Fibre Channel frame. This is applicable only in stripped mode. Values are as follows:
 - 000 – (0): EOF normal (EOFn)
 - 001 – (1): EOF terminate (EOFt)
 - 010 – (2): EOF disconnect terminate (EOFdt)
 - 011 – (3): EOF abort (EOFa)
 - 100 – (4): EOF normal invalid (EOFni)
 - 101 – (5): EOF disconnect terminate Invalid (EOFdti)
 - 110 – (6): EOF remove terminate (EOFrt)
 - 111 – (7): EOF remove terminate invalid (EOFrti)
- Start of Frame (SOF). Bits 15-12 indicate a binary value for the start-of-frame delimiter that began the Fibre Channel frame. This is applicable only in stripped mode. Values are as follows:
 - 0000 – (0): SOF connect class-1 (SOFc1)
 - 0001 – (1): SOF initiate class-1 (SOFi1)
 - 0010 – (2): SOF normal class-1 (SOFn1)
 - 0011 – (3): SOF initiate class-2 (SOFi2)
 - 0100 – (4): SOF normal class-2 (SOFn2)
 - 0101 – (5): SOF initiate class-3 (SOFi3)
 - 0110 – (6): SOF normal class-3 (SOFn3)
 - 0111 – (7): SOF activate class-4 (SOFc4)

- 1000 – (8): SOF initiate class-4 (SOFi4)
- 1001 – (9): SOF normal class-4 (SOFn4)
- 1010 – (A): SOF fabric (SOFF)
- 1011 – 1111(B-F): Reserved

- Frame Length. In stripped mode, bits 11-0 indicate the length of the frame’s data payload in bytes (excluding the SOF and EOF delimiters and CRC word). In stripped mode, maximum length is 2112 bytes. In non-stripped mode, bits 11-0 indicate the length of the entire Fibre Channel frame in bytes. The frame length must be divisible by 4.

11.2.18.2 Fibre Channel Data Packets, Format 1 (FC-FS Layer)

Data from a Fibre Channel port can be placed into a Fibre Channel Data Packet Format 1. In this format, the Fibre Channel frames placed in the packet include only the frame header and data field. The Start-of-Frame delimiter, End-of-Frame delimiter, and CRC word of the frame are excluded. Fibre Channel Data Packet Format 1 is shown in [Table 11-58](#).

Table 11-58. Fibre Channel Data Packet, Format 1	
msb 15	lsb 0
PACKET HEADER	
CHANNEL-SPECIFIC DATA (BITS 15-0)	
CHANNEL-SPECIFIC DATA (BITS 31-16)	
INTRA-PACKET HEADER FOR FIBRE CHANNEL FRAME 1 (BITS 15-0)	
INTRA-PACKET HEADER FOR FIBRE CHANNEL FRAME 1 (BITS 31-16)	
INTRA-PACKET HEADER FOR FIBRE CHANNEL FRAME 1 (BITS 47-32)	
INTRA-PACKET HEADER FOR FIBRE CHANNEL FRAME 1 (BITS 63-48)	
INTRA-PACKET HEADER FOR FIBRE CHANNEL FRAME 1 (BITS 79-64)	
INTRA-PACKET HEADER FOR FIBRE CHANNEL FRAME 1 (BITS 95-80)	
FRAME BYTE 2	FRAME BYTE 1
:	:
FRAME BYTE n	FRAME BYTE n-1
:	
INTRA-PACKET HEADER FOR FIBRE CHANNEL FRAME n (BITS 15-0)	
INTRA-PACKET HEADER FOR FIBRE CHANNEL FRAME n (BITS 31-16)	
INTRA-PACKET HEADER FOR FIBRE CHANNEL FRAME n (BITS 47-32)	
INTRA-PACKET HEADER FOR FIBRE CHANNEL FRAME n (BITS 63-48)	
INTRA-PACKET HEADER FOR FIBRE CHANNEL FRAME n (BITS 79-64)	
INTRA-PACKET HEADER FOR FIBRE CHANNEL FRAME n (BITS 95-80)	
FRAME BYTE 2	FRAME BYTE 1
:	:
FRAME BYTE n	FRAME BYTE n-1
PACKET TRAILER	

- a. Fibre Channel Data Packet Channel-Specific Data Word. The packet body portion of each Fibre Channel Data Packet begins with a CSDW. It indicates how many Fibre

Channel frames are placed in the packet body. The CSDW is formatted for the complete type of packet body as shown in [Figure 11-103](#).

msb		lsb
31	16 15	0
RESERVED		NUMBER OF FRAMES

Figure 11-103. Fibre Channel Data Packet Channel-Specific Data Word Format

- Reserved. Bits 31-16 are reserved.
 - Number of Frames. Bits 15-0 contain a binary value that represents the number of Fibre Channel frames included in the packet.
- b. Fibre Channel Data Packet Format 1 Intra-Packet Header. After the channel-specific data, Fibre Channel frames are inserted into the packet. Each Fibre Channel frame is preceded by an IPH that has both an IPTS and an IPDH containing a frame status word. The length of the IPH is fixed at 12 bytes (96 bits) positioned contiguously, in the following sequence as shown in [Figure 11-104](#).

msb	lsb
31	0
TIME (LSLW)	
TIME (MSLW)	
FRAME STATUS WORD	

Figure 11-104. Fibre Channel Data Format 1 Intra-Packet Header

- Intra-Packet Time Stamp. These 8 bytes indicate the time tag of the Fibre Channel frame. The timestamp is sampled and latched at the end of the last bit of the Start-of-Frame delimiter. First long word bits 31-0 and second long word bits 31-0 indicate the following values:
 - The 48-bit RTC that corresponds to the first bit after the CSDW of the Fibre Channel frame with bits 31 to 16 in the second long word zero filled; or
 - The absolute time, if enabled by bit 6 in the packet flags (Subsection [11.2.1.1](#) item [g](#)). Time format is indicated by bits 2 and 3 in the packet flags (Subsection [11.2.1.1](#) item [g](#)).
- Frame Status Word. The frame status word precedes the Fibre Channel frame and is inserted into the packet with the format shown in [Figure 11-105](#).

msb												lsb
31	30	29	28	19	18	16	15	12	11	0		
FE	CE	OE	RESERVED	EOF	SOF	FRAME LENGTH						

Figure 11-105. Fibre Channel Data Format 1, (FC-FS Layer) Intra-Packet Frame Status Word

- Framing Error (FE). Bit 31 is used to indicate a framing error, such as EOF missing.

- 0 = No framing error.
- 1 = Framing error detected in Fibre Channel frame.
- CRC Error (CE). Bit 30 indicates a CRC error was detected.
 - 0 = No CRC error.
 - 1 = CRC error detected in Fibre Channel frame.
- Overrun Error (OE). Bit 29 is used to indicate a buffer overrun error.
 - 0 = No overrun error.
 - 1 = Overrun error detected prior to this Fibre Channel frame.
- Reserved. Bits 28-19 are reserved.
- End of Frame (EOF). Bits 18-16 indicate a binary value for the End-Of-Frame delimiter that terminated the Fibre Channel frame. Values are as follows:
 - 000 – (0): EOF normal (EOFn)
 - 001 – (1): EOF terminate (EOFt)
 - 010 – (2): EOF disconnect terminate (EOFdt)
 - 011 – (3): EOF abort (EOFa)
 - 100 – (4): EOF normal invalid (EOFni)
 - 101 – (5): EOF disconnect terminate invalid (EOFdti)
 - 110 – (6): EOF remove terminate (EOFrt)
 - 111 – (7): EOF remove terminate invalid (EOFrti)
- Start of Frame (SOF). Bits 15-12 indicate a binary value for the Start-Of-Frame delimiter that began the Fibre Channel frame. Values are as follows:
 - 0000 – (0): SOF connect class-1 (SOFc1)
 - 0001 – (1): SOF initiate class-1 (SOFi1)
 - 0010 – (2): SOF normal class-1 (SOFn1)
 - 0011 – (3): SOF initiate class-2 (SOFi2)
 - 0100 – (4): SOF normal class-2 (SOFn2)
 - 0101 – (5): SOF initiate class-3 (SOFi3)
 - 0110 – (6): SOF normal class-3 (SOFn3)
 - 0111 – (7): SOF activate class-4 (SOFc4)
 - 1000 – (8): SOF initiate class-4 (SOFi4)
 - 1001 – (9): SOF normal class-4 (SOFn4)
 - 1010 – (A): SOF fabric (SOFF)
 - 1011 – 1111(B-F): Reserved
- Frame Length. Bits 11-0 indicate the combined length of the Fibre Channel frame header and data fields (excludes the SOF, EOF delimiters, and CRC word of the frame) in bytes. This field must be evenly divisible by 4.

APPENDIX 11-A

Definitions

The following are definitions that are used in this standard and are provided as a means of removing ambiguities within the standard.

Absolute Time: A hypothetical time that either runs at the same rate for all the observers in the universe or the rate of time each observer can be scaled to by multiplying the observer's rate by a constant.

Byte: A contiguous set of 8 bits that are acted on as a unit.

Channel-Specific Data Word: A required word for each data type channel that has data-specific information.

Data Streaming: Streaming of current value data whether it is being recorded or not, and playback streaming of recorded data from a file. Data streaming sends the data to one or more destinations simultaneously (e.g., recording media, recorder data interfaces).

Extended Relative Time Counter: A 1-GHz extension to the existing 10-MHz RTC.

Long Word: A contiguous set of 32 bits that are acted on as a unit.

Mandatory: Defines a mandatory requirement of this standard for full compliancy. Mandatory requirements as defined in this standard are based on the use of "shall".

Multiplexer: The entity that includes all the inputs, control interfaces, and functionality required to properly record data.

Packet: Encapsulates a block of observational and ancillary application data to be recorded.

Packet Generation: The placing of observational and ancillary data into a packet.

Recorder: Is used where a function or requirement shall apply to both an on-board recorder and a ground-based recorder.

Recording: Is defined as the time interval from first packet generated to the last packet committed to the recorder media. Packet generation time and stream commit time, as defined within the standard, apply.

Session: Period of time during which data is acquired, processed and/or stored. Typically corresponds to a recording (q.v.)

Setup Record: TMATS IAW [Chapter 9](#) annotated in the Computer-Generated Data, Format 0 packet.

Stream: All packets from all enabled channels (including computer-generated data) that are generated.

Stream Commit Time: The time span in which all generated packets must be committed to a stream.

Word: A contiguous set of 16 bits acted on as a unit.

This page intentionally left blank.

APPENDIX 11-B

Citations

- Automated Imaging Association. *GiGE Vision*. Version 1.2. n.d. Retrieved 6 July 2020. Available for download with registration at http://www.visiononline.org/form.cfm?form_id=735.
- Department of Defense. "Aircraft Internal Time Division Command/Response Multiplex Data Bus." MIL-STD-1553B. 21 September 1978. Superseded by update 28 February 2018. Retrieved 6 July 2020. Available at https://quicksearch.dla.mil/qsDocDetails.aspx?ident_number=36973.
- . "National Imagery Transmission Format Version 2.1." MIL-STD-2500C w/Change 2. 2 January 2019. May be superseded by update. Retrieved 6 July 2020. Available at https://quicksearch.dla.mil/qsDocDetails.aspx?ident_number=112606.
- European Air Group. "European Air Group Interface Control Document for Post Mission Interoperability." DF29125 Draft A Issue 01. July 2004. Retrieved 6 July 2020. Available to RCC members with Private Portal access at https://wsdmext.wsmr.army.mil/site/rccpri/Limited_Distribution_References/DF29125.pdf.
- European Machine Vision Association. *GenICam Standard Features Naming Convention*. Version 1.5. November 2011. Retrieved 6 July 2020. Available at http://www.emva.org/wp-content/uploads/GenICam_SFNC_1_5.pdf.
- Institute of Electrical and Electronics Engineers. *IEEE Standard for a Precision Clock Synchronization Protocol for Networked Measurement and Control Systems*. IEEE 1588-2008. Geneva: International Electrotechnical Commission, 2008.
- . *IEEE Standard for a High-Performance Serial Bus*. IEEE 1394-2008. New York: Institute of Electrical and Electronics Engineers, 2008.
- . *IEEE Standard for a High Performance Serial Bus: Amendment 2*. IEEE 1394b-2002. New York: Institute of Electrical and Electronics Engineers, 2002.
- . *IEEE Standard for a High Performance Serial Bus*. IEEE 1394-1995. New York: Institute of Electrical and Electronics Engineers, 1995.
- . *IEEE Standard for Ethernet*. IEEE 802.3-2012. New York: Institute of Electrical and Electronics Engineers.
- International Organization for Standardization/International Electrotechnical Commission. "General sequential and progressive syntax", Annex B, section B.2, in *Information technology -- Digital compression and coding of continuous-tone still images*:

Requirements and guidelines. ISO/IEC 10918-1:1994. May be superseded by update. Geneva: International Organization for Standardization, 1994.

- . *Information Technology - Coding of Audio-Visual Objects - Part 3: Audio.* ISO/IEC 14496-3:2019. 12 December 2019. May be superseded by update. Retrieved 6 July 2020. Available for purchase at <https://webstore.iec.ch/publication/63839>.
- . *Information Technology - Coding of Audio-Visual Objects - Part 10: Advanced Video Coding.* ISO/IEC 14496-10:2014. 1 September 2014. May be superseded by update. Retrieved 6 July 2020. Available at <http://standards.iso.org/ittf/PubliclyAvailableStandards/index.html>.
- . *Information technology--Generic coding of moving pictures and associated audio information -- Part 3, Audio.* ISO/IEC 13818-3:1998. Geneva: International Organization for Standardization, 1998.
- . *Information technology -- Generic coding of moving pictures and associated audio information -- Part 7: Advanced Audio Coding (AAC).* ISO/IEC 13818-7:2006(E). Geneva: International Organization for Standardization, 2006.
- . *Information technology -- Generic coding of moving pictures and associated audio information: Systems.* ISO/IEC 13818-1:2007. October 2007. Updated by ISO/IEC 13818-1:2015. Retrieved 6 July 2020. Available for purchase at <https://www.iso.org/standard/62074.html>.
- . *Information Technology -- JPEG 2000 Image Coding System: Core Coding System.* ISO/IEC 15444-1:2016. October 2016. Revised by ISO/IEC 15444-1-2019. Retrieved 6 July 2020. Revised version available for purchase at <https://www.iso.org/standard/78321.html>.
- . *Information technology: JPEG 2000 image coding system: motion JPEG 2000.* ISO/IEC 15444-3:2007. Geneva: International Organization for Standardization, 2007.

International Telecommunications Union Telecommunication Standardization Sector.

Information technology - Generic coding of moving pictures and associated audio information: Systems. ITU-T Rec.H.222.0 (08/18). 29 August 2018. May be superseded by update. Retrieved 6 July 2020. Available at <http://www.itu.int/rec/T-REC-H.222.0/en>.

Internet Engineering Task Force. “Network Time Protocol (Version 3) Specification, Implementation and Analysis.” RFC 1305. March 1992. Obsoleted by RFC 5905. Retrieved 6 July 2020. Available at <https://datatracker.ietf.org/doc/rfc1305/>.

Lockheed Martin Corporation. “Advanced Weapons Multiplex Data Bus.” 8 June 2010. May be superseded by update. Retrieved 6 July 2020. Available to RCC members with Private Portal access at https://wsdmext.wsmr.army.mil/site/rccpri/Limited_Distribution_References/16PP362B.pdf.

- Motion Imagery Standards Board. *Bit and Byte Order for Metadata in Motion Imagery Files and Streams*. STD 107.1. June 2011. Superseded by ST 0107.4. Retrieved 6 July 2020. Available at <http://www.gwg.nga.mil/misb/docs/standards/ST0107.1.pdf>.
- . “Data Encoding Using Key-Length-Value.” STD 9713 in *Motion Imagery Standards Profile*. MISP 6.4. 4 October 2012. Updated by MISP-2019.1. Retrieved 6 July 2020. Available at <http://www.gwg.nga.mil/misb/docs/misp/MISP-6.4.pdf>.
- . “Imbedded Time Reference for Motion Imagery Systems.” STD 9708 in *Motion Imagery Standards Profile*. MISP 6.4. 4 October 2012. Updated by MISP-2019.1. Retrieved 6 July 2020. Available at <http://www.gwg.nga.mil/misb/docs/misp/MISP-6.4.pdf>.
- . “Intelligence Motion Imagery Index, Content Description...” STD 9712 in *Motion Imagery Standards Profile*. MISP 6.4. 4 October 2012. Updated by MISP-2019.1. Retrieved 6 July 2020. Available at <http://www.gwg.nga.mil/misb/docs/misp/MISP-6.4.pdf>.
- . “Intelligence Motion Imagery Index, Geospatial Metadata.” STD 9711 in *Motion Imagery Standards Profile*. MISP 6.4. 4 October 2012. Updated by MISP-2019.1. Retrieved 6 July 2020. Available at <http://www.gwg.nga.mil/misb/docs/misp/MISP-6.4.pdf>.
- . “Motion Imagery Systems Matrix, Standard Definition Motion Imagery.” RP 9720d in *Motion Imagery Standards Profile*. MISP 6.4. 4 October 2012. Updated by MISP-2019.1. Retrieved 6 July 2020. Available at <http://www.gwg.nga.mil/misb/docs/misp/MISP-6.4.pdf>.
- . “Packing KLV Packets into MPEG-2 Systems Streams.” RP 9717 in *Motion Imagery Standards Profile*. MISP 6.4. 4 October 2012. Updated by MISP-2019.1. Retrieved 6 July 2020. Available at <http://www.gwg.nga.mil/misb/docs/misp/MISP-6.4.pdf>.
- . “Standard Definition Digital Motion Imagery, Compression Systems.” STD 9601 in *Motion Imagery Standards Profile*. MISP 6.4. 4 October 2012. Updated by MISP-2019.1. Retrieved 6 July 2020. Available at <http://www.gwg.nga.mil/misb/docs/misp/MISP-6.4.pdf>.
- . “Time Reference Synchronization.” STD 9715 in *Motion Imagery Standards Profile*. MISP 6.4. 4 October 2012. Updated by MISP-2019.1. Retrieved 6 July 2020. Available at <http://www.gwg.nga.mil/misb/docs/misp/MISP-6.4.pdf>.
- . “Use of MPEG-2 System Streams in Digital Motion Imagery Systems.” RP 0101.1. 27 January 2011. Superseded by MISB ST 1402. Retrieved 6 July 2020. Available at <http://www.gwg.nga.mil/misb/docs/rp/RP0101.1.pdf>.
- . “Xon2”. Subsection D-1.2 in *Motion Imagery Standards Profile*. MISP 6.4. 4 October 2012. Updated by MISP-2019.1. Retrieved 6 July 2020. Available at <http://www.gwg.nga.mil/misb/docs/misp/MISP-6.4.pdf>.

Range Commanders Council. *IRIG Serial Time Code Formats*. RCC 200-16. August 2016. May be superseded by update. Retrieved 6 July 2020. Available at <https://www.trmc.osd.mil/wiki/x/wou8Bg>.

Range Instrumentation System Program Office, Air Armament Center. “Interface Specification for the USAF Air Combat Test and Training System (ACTTS) Air-to-Ground, Air-to-Air, Ground-to-Air Data Links, and AIS Recording Formats.” WMSP 98-01, Rev A, Chg 1. 19 May 2003. Retrieved 6 July 2020. Available to RCC members with Private Portal access at https://wadmext.wsmr.army.mil/site/rccpri/Limited_Distribution_References/WMSP_98-01.doc.

****** END OF CHAPTER 11 ******