

ANNEX A-2
Magnetic Tape Recorder and Reproducer Information
and Use Criteria

Acronyms **A.2-v**

Annex A.2. Magnetic Tape Recorder and Reproducer Information and Use Criteria..... **A.2-1**

1. Other Instrumentation Magnetic Tape Recorder Standards **A.2-1**

2. Double-Density Longitudinal Recording **A.2-1**

 2.1. Other Track Configurations A.2-2

 2.2. High-Density Pulse Code Modulation Recording. A.2-2

3. Serial High-Density Digital Recording..... **A.2-6**

 3.1. Some characteristics of the Bi ϕ -L code A.2-6

 3.2. Favorable characteristics of the RNRZ-L code A.2-7

 3.3. Unfavorable characteristics of the RNRZ-L code A.2-7

 3.4. Randomizer for RNRZ-L..... A.2-8

4. Head Parameters..... **A.2-12**

 4.1. Gap Scatter A.2-12

 4.2. Head Polarity A.2-13

5. Record Level..... **A.2-13**

6. Tape Crossplay Considerations **A.2-13**

7. Standard Tape Signature Procedures..... **A.2-14**

 7.1. PCM Signature Recording Procedure A.2-14

 7.2. PCM Signature Playback Procedure A.2-15

 7.3. Swept-Frequency Signature Recording Procedure A.2-15

 7.4. Swept-Frequency Signature Playback Procedure A.2-15

8. Equipment Required for Swept-Frequency Procedures..... **A.2-16**

9. Fixed-Frequency Plus White Noise Procedure..... **A.2-16**

10. Signature Playback and Analysis **A.2-17**

11. Recording and Playback Alignment Procedures **A.2-18**

 11.1. Recording of Preamble for Direct Electronics Alignment..... A.2-18

 11.2. Playback of Preamble for Direct Electronics Alignment..... A.2-18

 11.3. Recording of Preamble for FM Electronics Alignment..... A.2-19

 11.4. Playback of Preamble for FM Electronics Alignment..... A.2-19

12. General Considerations for Longitudinal Recording..... **A.2-20**

 12.1. Tape Speeds A.2-20

 12.2. Tape Width..... A.2-20

| | | |
|------------|---|---------------|
| 12.3. | Record and Reproduce Bandwidths..... | A.2-20 |
| 13. | Recorded Tape Format..... | A.2-20 |
| 13.1. | Track Width and Spacing..... | A.2-23 |
| 13.2. | Track Numbering..... | A.2-23 |
| 13.3. | Data Spacing..... | A.2-23 |
| 13.4. | Head Placement..... | A.2-24 |
| 14. | Head and Head Segment Mechanical Parameters..... | A.2-27 |
| 14.1. | Gap Scatter..... | A.2-27 |
| 14.2. | Head Segment Gap Azimuth Alignment..... | A.2-28 |
| 14.3. | Head Tilt..... | A.2-28 |
| 14.4. | Record-Head Segment Gap Parameters..... | A.2-28 |
| 15. | Head Polarity..... | A.2-28 |
| 15.1. | Record-Head Segment..... | A.2-28 |
| 15.2. | Reproduce-Head Segment..... | A.2-28 |
| 16. | Magnetic Tape and Reel Characteristics..... | A.2-29 |
| 16.1. | Tape Width..... | A.2-29 |
| 16.2. | Tape Guiding..... | A.2-29 |
| 17. | Direct Record and Reproduce Systems..... | A.2-29 |
| 17.1. | Direct Record Parameters..... | A.2-29 |
| 17.2. | Standard Record Level..... | A.2-30 |
| 17.3. | Reproduce Parameters..... | A.2-30 |
| 17.4. | Tape Speed and Flutter Compensation..... | A.2-30 |
| 18. | Timing, Predetection, and Tape Signature Recording..... | A.2-31 |
| 18.1. | Timing Signal Recording..... | A.2-31 |
| 18.2. | Predetection Recording..... | A.2-32 |
| 18.3. | Tape Signature Recording..... | A.2-32 |
| 19. | FM Record Systems..... | A.2-32 |
| 20. | PCM Recording..... | A.2-34 |
| 20.1. | Predetection PCM Recording..... | A.2-34 |
| 20.2. | Post-Detection PCM Recording..... | A.2-34 |
| 20.3. | Serial High-Density Digital Recording..... | A.2-35 |
| 20.4. | Direct Recording of PCM Telemetry Data..... | A.2-35 |
| 21. | Preamble Recording for Automatic or Manual Recorder Alignment..... | A.2-38 |
| 21.1. | Alignment, Direct Electronics..... | A.2-38 |
| 21.2. | Alignment, FM Electronics..... | A.2-38 |
| 22. | Magnetic Tape Standards: General..... | A.2-38 |
| 23. | Definitions..... | A.2-40 |
| 24. | General Requirements for Standard Instrumentation Tapes and Reels..... | A.2-42 |

| | | |
|--------------------|---|---------------|
| 24.1. | Reference Tape System..... | A.2-42 |
| 24.2. | Marking and Identifying | A.2-43 |
| 24.3. | Packaging..... | A.2-43 |
| 24.4. | Winding..... | A.2-43 |
| 24.5. | Reels and Hubs | A.2-43 |
| 24.6. | Radial Clearance (E-Value) | A.2-43 |
| 24.7. | Flammable Materials | A.2-43 |
| 24.8. | Toxic Compounds..... | A.2-43 |
| 25. | General Characteristics of Instrumentation Tapes and Reels..... | A.2-43 |
| 25.1. | Dimensional Specifications | A.2-44 |
| 25.2. | Environmental Conditions | A.2-44 |
| 25.3. | Other Characteristics..... | A.2-45 |
| 26. | Physical Characteristics of Instrumentation Tapes and Reels | A.2-45 |
| 27. | Instrumentation Tape Magnetic and Electrical Characteristics | A.2-45 |
| 27.1. | Bias Level | A.2-46 |
| 27.2. | Record Level..... | A.2-46 |
| 27.3. | Wavelength Response..... | A.2-46 |
| 27.4. | Output at 0.1 UBE Wavelength | A.2-46 |
| 27.5. | Short Wavelength Output Uniformity | A.2-47 |
| 27.6. | Dropouts..... | A.2-47 |
| 27.7. | Durability | A.2-48 |
| 27.8. | Modulation Noise..... | A.2-48 |
| 27.9. | Layer-to-Layer Signal Transfer | A.2-48 |
| 27.10. | Erase Ease..... | A.2-48 |
| 27.11. | Suggested Tape Requirement Limits | A.2-48 |
| Appendix A. | Citations..... | A.2-49 |

List of Figures

| | | |
|----------------|---|--------|
| Figure A.1-1. | Record and reproduce head and head segment identification and location (7-track interlaced system)..... | A.2-3 |
| Figure A.1-2. | Randomizer block diagram | A.2-8 |
| Figure A.1-3. | Randomized NRZ-L decoder block diagram | A.2-9 |
| Figure A.1-4. | Random PCM power spectra | A.2-11 |
| Figure A.1-5. | Bi ϕ -L at bit packing density of 15 kb/in | A.2-12 |
| Figure A.1-6. | RNRZ-L at bit packing density of 25 kb/in | A.2-12 |
| Figure A.1-7. | Tape Crossplay..... | A.2-14 |
| Figure A.1-8. | Square wave responses | A.2-19 |
| Figure A.1-9. | Recorded tape format..... | A.2-21 |
| Figure A.1-10. | Head and head segment mechanical parameters..... | A.2-21 |
| Figure A.1-11. | Record and reproduce head and head segment identification and location (N-track interlaced system)..... | A.2-22 |
| Figure A.1-12. | PCM record and reproduce configuration..... | A.2-23 |

Figure A.1-13. Serial high-density digital record and reproduce A.2-36

List of Tables

Table A.1-1. Dimensions - Recorded Tape Format - 7 Tracks Interlaced on 12.7-mm (0.5 inch)-Wide Tape (Refer to Figure A.1-9)..... A.2-4

Table A.1-2. Dimensions - Recorded Tape Format - 14 Tracks Interlaced on 12.7-mm (0.5 inch) Wide Tape (Refer to Figure A.1-9)..... A.2-4

Table A.1-3. Dimensions - Recorded Tape Format - 42 Tracks Interlaced on 25.4-mm (1 inch) Wide Tape (Refer to Figure A.1-9)..... A.2-5

Table A.1-4. Record and Reproduce Parameters A.2-24

Table A.1-5. Dimensions - Recorded Tape Format - 14 Tracks Interlaced on 25.4 mm (1 inch) Wide Tape⁽¹⁾ A.2-25

Table A.1-6. Dimensions - Recorded Tape Format - 14 Tracks In-Line On 25.4 mm (1 inch) Wide Tape⁽¹⁾ A.2-26

Table A.1-7. Dimensions - Recorded Tape Format - 14 Tracks Interlaced On 25.4 mm (1 inch) Wide Tape⁽¹⁾ A.2-26

Table A.1-8. Upper Band Edge Maximum Level A.2-29

Table A.1-9. Constant Amplitude Speed Control Signals⁽¹⁾ A.2-31

Table A.1-10. Predetection Carrier Parameters A.2-32

Table A.1-11. Wide-band and Double-Density FM Record Parameters A.2-33

Table A.1-12. Maximum Recommended Bit Rates, Post-Detection Recording⁽¹⁾..... A.2-34

Table A.1-13. Maximum Recommended Bit Rates A.2-35

Table A.1-14. Suggested Tape Requirement Limits A.2-38

Table A.1-15. Suggested Wavelength Response Requirements A.2-39

Table A.1-16. Durability Signal Losses A.2-39

Table A.1-17. Tape Dimensions A.2-44

Table A.1-18. Environment Recommended Limits A.2-44

Table A.1-19. Measurement Wavelengths..... A.2-46

Acronyms

| | |
|--------|--|
| μm | micrometer |
| ANSI | American National Standards Institute |
| b/mm | bits per millimeter |
| Biφ | bi-phase |
| Biφ-L | bi-phase-level |
| dB | decibel |
| dc | direct current |
| FM | frequency modulation |
| ft | feet |
| HDD | High-Density Digital |
| HDDR | High-Density Digital Recording |
| HE | High-Energy |
| HR | High-Resolution |
| Hz | hertz |
| in | inch |
| in/s | inches per second |
| IRIG | Inter-Range Instrumentation Group |
| ISO | International Organization for Standardization |
| kA/m | kiloamps per meter |
| kb/in | kilobits per inch |
| kb/s | kilobits per second |
| kHz | kilohertz |
| Mb/s | megabits per second |
| MCT | manufacturer's centerline tape |
| MHz | megahertz |
| mm | millimeter |
| mm/s | millimeters per second |
| MSCT | manufacturer's secondary centerline tape |
| NRZ-L | non-return-to-zero level |
| PCM | pulse code modulation |
| RM | relative humidity |
| rms | root mean square |
| RNRZ-L | randomized non-return-to-zero level |
| SNR | signal-to-noise ratio |
| UBE | upper band edge |
| V | volt |
| Vdc | volts direct current |
| WRT | working reference tape |

This page intentionally left blank.

ANNEX A.2

Magnetic Tape Recorder and Reproducer Information and Use Criteria

1. Other Instrumentation Magnetic Tape Recorder Standards

The X3B6 Committee of the American National Standards Institute (ANSI) and the International Organization for Standardization (ISO) have prepared several standards for magnetic tape recording of instrumentation data. Documents may be obtained by contacting the ANSI web site (<http://webstore.ansi.org>).

Documentation applicable to this annex is identified in the following bullets.

- ISO 1860 (1986), Information Processing - Precision reels for magnetic tape used in interchange instrumentation applications.
- ISO 6068 (1985), Information Processing - Recording characteristics of instrumentation magnetic tape (including telemetry systems) - interchange requirements.
- ISO/IEC TR 6371:1989, Information Processing - Interchange practices and test methods for unrecorded instrumentation magnetic tape.
- ISO/IEC 8441/1:1991, Information technology - High Density Digital Recording (HDDR) - Part 1: Unrecorded magnetic tape for HDDR applications.
- ISO/IEC 8441/2:1991, Information technology - High Density Digital Recording (HDDR) - Part 2: Guide for interchange practice.
- ANSI INCITS 175-1999, 19 mm Type ID-1 Recorded Instrumentation - Digital Cassette Tape Format (formerly ANSI X3.175-1990).

2. Double-Density Longitudinal Recording

Wide-band double-density analog recording standards allowing recording of up to 4 megahertz (MHz) signals at 3048 mm/s (120 in/s) are included in these standards. For interchange purposes, either narrow track widths 0.635 mm (25 mils) must be employed, or other special heads must be used. These requirements are necessary because of the difficulty in maintaining individual head-segment gap-azimuth alignment across a head close enough to keep each track's response within the ± 2 -dB variation allowed by the standards. Moreover, at the lower tape speeds employed in double-density recording, the 38-mm (1.5-in.) spacing employed in interlaced head assemblies result in interchannel time displacement variations between odd and even tracks that may be unacceptable for some applications. Therefore, it was decided that a 14-track in-line configuration on 25.4-mm (1-in.) tape should be adopted as a standard. This configuration results in essentially the same format as head number one of the 28-track interlaced configuration in the standards.

The 14-track interlaced heads are not compatible with tapes produced on an in-line standard configuration. If tapes must be interchanged, either a cross-configuration dubbing may be required or a change of head assemblies on the reproducing machine is necessary.

High energy magnetic tape is required for double-density systems. Such tapes are available but may require special testing for applications requiring a low number of dropouts per track.

2.1. Other Track Configurations

The previously referenced standards in Section [1](#) include configurations resulting in 7, 14, and 21 tracks in addition to the 14-track and 28-track configurations listed in this annex. The high-density digital recording (HDDR) standards also reference an 84-track configuration on 50.8-mm (2-in.) tape. [Figure A.2-1](#) and [Table A.2-1](#) show the 7-track on 12.7-mm (0.5 in.) tape, [Table A.2-2](#) shows the 14-track on 12.7-mm (0.5 in.) tape, and [Table A.2-3](#) shows the 42-track on 25.4-mm (1 in.) tape configurations.

2.2. High-Density Pulse Code Modulation Recording.

High-density digital recording systems are available from most instrumentation recorder manufacturers. Such systems will record at linear packing densities of 33,000 bits per inch or more per track. Special systems are available for error detection and correction with overhead penalties depending on the type and the sophistication of the system employed. The HDDR documents listed in Section [1](#) reference six different systems that have been produced; others are available.

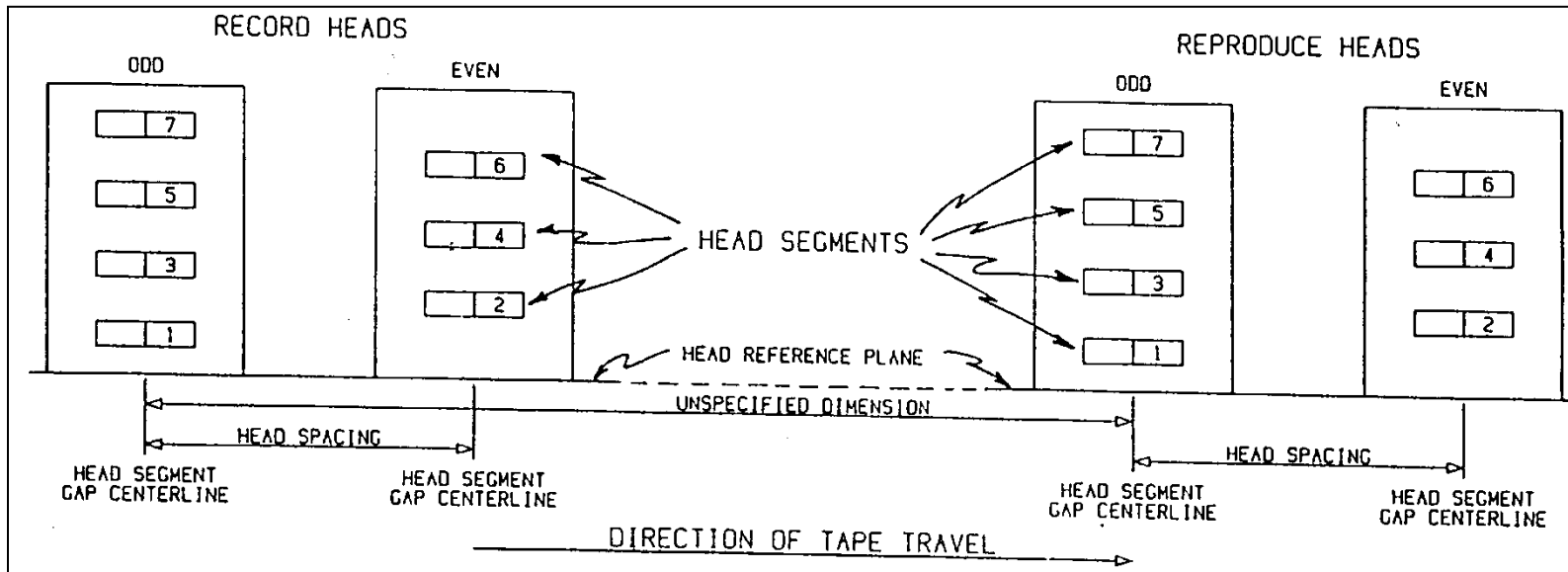

Figure A.2-1. Record and reproduce head and head segment identification and location (7-track interlaced system)

| Table A.2-1. Dimensions - Recorded Tape Format - 7 Tracks Interlaced on 12.7-mm (0.5 inch)-Wide Tape (Refer to Figure A.2-9) | | |
|---|----------------------------|---------------|
| Parameters | Millimeters | Inches |
| Track Width | 1.397 (Max); 1.143 (Min) | 0.050±0.005 |
| Track Spacing | 1.778 | 0.070 |
| Fixed Head Spacing | 38.125 (Max); 38.075 (Min) | 1.500±0.001 |
| Adjustable Head Spacing | 38.151 (Max); 38.049 (Min) | 1.500±0.002 |
| Edge Margin, Minimum | 0.127 | 0.005 |
| Reference Track Location | 1.067 (Max); 0.965 (Min) | 0.040±0.002 |
| Track Location Tolerance | 0.051 (Max); -0.051 (Min) | ±0.002 |
| Location of nth Track | | |
| Track Number | Millimeters | Inches |
| 1 (Reference) | 0.000 | 0.000 |
| 2 | 1.829 (Max); 1.727 (Min) | 0.070 |
| 3 | 3.607 (Max); 3.505 (Min) | 0.140 |
| 4 | 5.385 (Max); 5.283 (Min) | 0.210 |
| 5 | 7.163 (Max); 7.061 (Min) | 0.280 |
| 6 | 8.941 (Max); 8.839 (Min) | 0.350 |
| 7 | 10.719 (Max); 10.617 (Min) | 0.420 |

| Table A.2-2. Dimensions - Recorded Tape Format - 14 Tracks Interlaced on 12.7-mm (0.5 inch) Wide Tape (Refer to Figure A.2-9) | | |
|--|----------------------------|---------------|
| Parameters | Millimeters | Inches |
| Track Width | 0.660 (Max); 0.610 (Min) | 0.025±0.001 |
| Track Spacing | 0.889 | 0.035 |
| Fixed Head Spacing | 38.125 (Max); 38.075 (Min) | 1.500±0.001 |
| Adjustable Head Spacing | 38.151 (Max); 38.049 (Min) | 1.500±0.002 |
| Edge Margin, Minimum | 0.127 | 0.005 |
| Reference Track Location | 0.546 (Max); 0.470 (Min) | 0.0200±0.001 |
| Track Location Tolerance | 0.038 (Max); -0.038 (Min) | ±0.0015 |
| Location of nth Track | | |
| Track Number | Millimeters | Inches |
| 1(Reference) | 0.000 | 0.000 |
| 2 | 0.927 (Max); 0.851 (Min) | 0.035 |
| 3 | 1.816 (Max); 1.740 (Min) | 0.070 |
| 4 | 2.705 (Max); 2.629 (Min) | 0.140 |
| 5 | 3.594 (Max); 3.518 (Min) | 0.210 |
| 6 | 4.483 (Max); 4.407 (Min) | 0.280 |
| 7 | 5.372 (Max); 5.292 (Min) | 0.350 |
| 8 | 6.261 (Max); 6.185 (Min) | 0.245 |
| 9 | 7.150 (Max); 7.074 (Min) | 0.280 |
| 10 | 8.039 (Max); 7.963 (Min) | 0.315 |

| | | |
|----|----------------------------|-------|
| 11 | 8.928 (Max); 8.852 (Min) | 0.350 |
| 12 | 9.817 (Max); 9.741 (Min) | 0.385 |
| 13 | 10.706 (Max); 10.630 (Min) | 0.420 |
| 14 | 11.595 (Max); 11.519 (Min) | 0.455 |

Table A.2-3. Dimensions - Recorded Tape Format - 42 Tracks Interlaced on 25.4-mm (1 inch) Wide Tape (Refer to [Figure A.2-9](#))

| Parameters | Millimeters | Inches |
|-----------------------------------|----------------------------|--------------|
| Track Width | 0.483 (Max); 0.432 (Min) | 0.018±0.001 |
| Track Spacing | 0.584 | 0.023 |
| Fixed Head Spacing | 38.125 (Max); 38.075 (Min) | 1.500±0.001 |
| Adjustable Head Spacing | 38.151 (Max); 38.049 (Min) | 1.500±0.002 |
| Edge Margin, Minimum | 0.305 | 0.012 |
| Reference Track Location | 0.737 (Max); 0.660 (Min) | 0.0275±0.015 |
| Track Location Tolerance | 0.025 (Max); -0.025 (Min) | ±0.0000 |
| Location of n th Track | | |
| Track Number | Millimeters | Inches |
| 1 (Reference) | 0.000 | 0.000 |
| 2 | 0.610 (Max); 0.559 (Min) | 0.023 |
| 3 | 1.194 (Max); 1.143 (Min) | 0.046 |
| 4 | 1.778 (Max); 1.727 (Min) | 0.069 |
| 5 | 2.362 (Max); 2.311 (Min) | 0.092 |
| 6 | 2.946 (Max); 2.896 (Min) | 0.115 |
| 7 | 3.531 (Max); 3.480 (Min) | 0.138 |
| 8 | 4.115 (Max); 4.064 (Min) | 0.161 |
| 9 | 4.699 (Max); 4.648 (Min) | 0.184 |
| 10 | 5.283 (Max); 5.232 (Min) | 0.207 |
| 11 | 5.867 (Max); 5.817 (Min) | 0.230 |
| 12 | 6.452 (Max); 6.401 (Min) | 0.253 |
| 13 | 7.036 (Max); 6.985 (Min) | 0.276 |
| 14 | 7.620 (Max); 7.569 (Min) | 0.299 |
| 15 | 8.204 (Max); 8.153 (Min) | 0.322 |
| 16 | 8.788 (Max); 8.768 (Min) | 0.345 |
| 17 | 9.373 (Max); 9.322 (Min) | 0.368 |
| 18 | 9.957 (Max); 9.906 (Min) | 0.397 |
| 19 | 10.541 (Max); 10.490 (Min) | 0.414 |
| 20 | 11.125 (Max); 11.074 (Min) | 0.437 |
| 21 | 11.709 (Max); 11.659 (Min) | 0.460 |
| 22 | 12.294 (Max); 12.243 (Min) | 0.483 |
| 23 | 12.878 (Max); 12.827 (Min) | 0.506 |
| 24 | 13.462 (Max); 13.411 (Min) | 0.529 |
| 25 | 14.046 (Max); 13.995 (Min) | 0.552 |
| 26 | 14.630 (Max); 14.580 (Min) | 0.575 |

| | | |
|----|----------------------------|-------|
| 27 | 15.215 (Max); 15.164 (Min) | 0.598 |
| 28 | 15.799 (Max); 15.748 (Min) | 0.621 |
| 29 | 16.383 (Max); 16.332 (Min) | 0.664 |
| 30 | 16.967 (Max); 16.916 (Min) | 0.667 |
| 31 | 17.551 (Max); 17.501 (Min) | 0.690 |
| 32 | 18.136 (Max); 18.085 (Min) | 0.713 |
| 33 | 18.720 (Max); 18.660 (Min) | 0.736 |
| 34 | 19.304 (Max); 19.253 (Min) | 0.759 |
| 35 | 19.888 (Max); 19.837 (Min) | 0.782 |
| 36 | 20.472 (Max); 20.422 (Min) | 0.805 |
| 37 | 21.057 (Max); 21.006 (Min) | 0.828 |
| 38 | 21.641 (Max); 21.590 (Min) | 0.851 |
| 39 | 22.225 (Max); 22.174 (Min) | 0.874 |
| 40 | 22.809 (Max); 22.758 (Min) | 0.897 |
| 41 | 23.393 (Max); 23.343 (Min) | 0.920 |
| 42 | 23.978 (Max); 23.927 (Min) | 0.943 |

3. Serial High-Density Digital Recording

The following paragraphs give some background for selecting the bi-phase ($\text{Bi}\phi$) and randomized non-return-to-zero-level (RNRZ-L) systems specified in Subparagraph [20.3](#).

Serial HDDR is a method of recording digital data on a magnetic tape where the digital data is applied to one track of the recording system as a bi-level signal. The codes recommended for serial HDDR recording of telemetry data are $\text{Bi}\phi$ -level ($\text{Bi}\phi$ -L) and RNRZ-L (refer to Paragraph [20](#)).

In preparing Paragraph [20](#), the following codes were considered: Delay Modulation (Miller Code), Miller Squared, Enhanced NRZ, NRZ Level, NRZ Mark, and NRZ Space. These codes are not recommended for interchange applications at the bit rates given in Paragraph [20](#).

The properties of the $\text{Bi}\phi$ -L and RNRZ-L codes relevant to serial HDDR and the methods for generating and decoding RNRZ-L are described next. Recording with bias is required for interchange applications because reproduce amplifier phase and amplitude equalization adjustments for tapes recorded without bias usually differ from those required for tapes recorded with bias.

The $\text{Bi}\phi$ -L and RNRZ-L codes were selected for this standard because the “level” versions are easier to generate and are usually available as outputs from bit synchronizers. “Mark” and “Space” codes also have about twice as many errors as the level codes for the same signal-to-noise ratio (SNR). If polarity insensitivity is a major consideration, agreement between interchange parties should be obtained before these codes are used.

3.1. Some characteristics of the $\text{Bi}\phi$ -L code

- a. Only a small proportion of the total signal energy occurs near direct current (dc).
- b. The maximum time between transitions is a 1-bit period.

- c. The symbols for one and zero are antipodal, meaning that the symbols are exact opposites of each other. Therefore, the bit error probability versus SNR performance is optimum.
- d. The Bi ϕ -L can be decoded using existing bit synchronizers.
- e. The Bi ϕ -L is less sensitive to maladjustments of bias and reproducer equalizers than most other codes.
- f. The Bi ϕ -L performs well at low tape speeds and low bit rates.

The most unfavorable characteristic of the Bi ϕ -L code is that it requires approximately twice the bandwidth of NRZ. Consequently, the maximum bit packing density that can be recorded on magnetic tape is relatively low.

3.2. Favorable characteristics of the RNRZ-L code

- a. The RNRZ-L requires approximately one-half the bandwidth of Bi ϕ -L.
- b. The symbols for one and zero are antipodal; therefore, the bit error probability versus SNR performance is optimum.
- c. The RNRZ-L decoder is self-synchronizing.
- d. The RNRZ-L data can be bit synchronized and signal conditioned using existing bit synchronizers with the input code selector set to NRZ-L.
- e. The RNRZ-L code is easily generated and decoded.
- f. The RNRZ-L data can be easily decoded in the reverse mode of tape playback.
- g. The RNRZ-L data are bit detected and decoded using a clock at the bit rate. Therefore, the phase margin is much larger than that of codes that require a clock at twice the bit rate for bit detection.
- h. The RNRZ-L code does not require overhead bits.

3.3. Unfavorable characteristics of the RNRZ-L code

- a. Long runs of bits without a transition are possible, although the probability of occurrence is low, and the maximum run length can be limited by providing transitions in each data word.
- b. Each isolated bit error that occurs after the data has been randomized causes three bit errors in the derandomized output data.
- c. The decoder requires 15 consecutive error-free bits to establish and reestablish error-free operation.
- d. The RNRZ-L bit stream can have large low frequency content. Consequently, reproducing data at tape speeds which produce pulse code modulation (PCM) bit rates less than 200 kilobits per second (kb/s) is not recommended unless a bit synchronizer with specially designed dc and low frequency restoration circuitry is available.

3.4. Randomizer for RNRZ-L

The randomizer is implemented with a network of shift registers and modulo-2 adders (exclusive-OR gates). The RNRZ-L bit stream is generated by adding (modulo-2) the reconstructed NRZ-L PCM data to the modulo-2 sum of the outputs of the 14th and 15th stages of a shift register. The output RNRZ-L stream is also the input to the shift register (see [Figure A.2-2](#)).

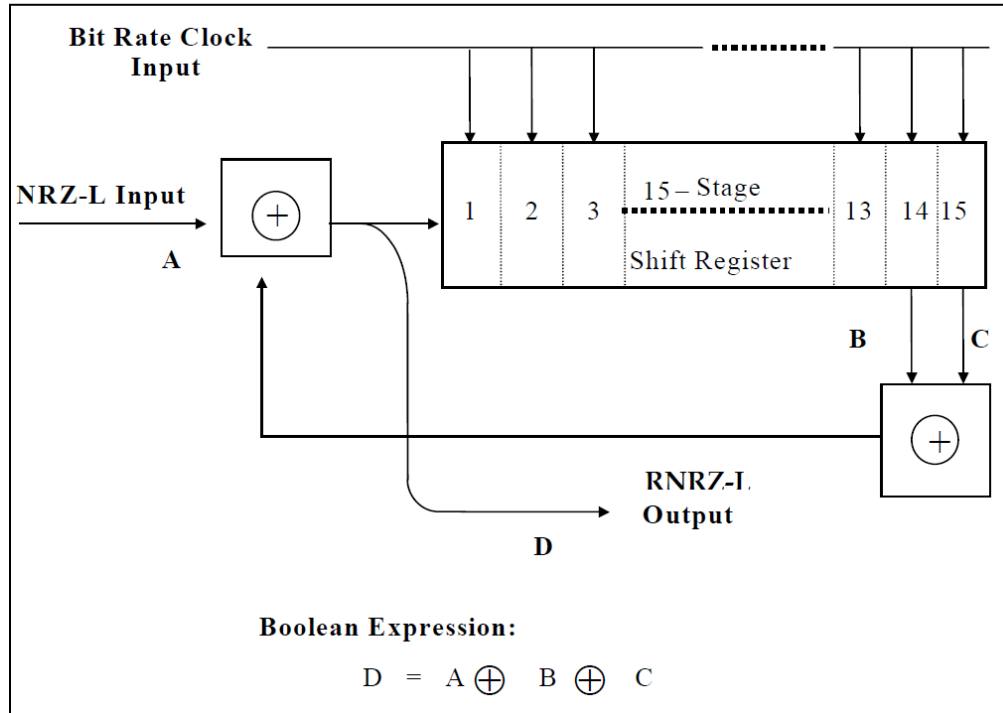

Figure A.2-2. Randomizer block diagram

The properties of an RNRZ-L bit stream are similar to the properties of a pseudo-random sequence. A 15-stage RNRZ-L encoder will generate a maximal length pseudo-random sequence of $2^{15}-1$ (32,767) bits if the input data consists only of zeros and there is at least a single one in the shift register. A maximal length pseudo-random sequence is also generated when the input data consists only of ones and the shift register contains at least a single zero; however, if the shift register contains all zeros at the moment that the input bit stream is all zeros, the RNRZ-L output bit stream will also be all zeros. The converse is also true, meaning that when the shift register is filled with ones and the input bit stream is all ones, the RNRZ-L output bit stream will also be all ones. In these two cases, the contents of the shift register do not change and the output data is not randomized; however, the randomizer is not permanently locked-up in this state because a change in the input data will again produce a randomized output. In general, if the input bit stream contains runs of X bits without a transition with a probability of occurrence of $p(X)$, the output will contain runs having a length of up to $(X+15)$ bits with a probability equal to $(2^{-15} \cdot p(X))$. Therefore, the output can contain long runs of bits without a transition, but the probability of occurrence is low.

The RNRZ-L bit stream is decoded (derandomized) by adding (modulo-2) the reconstructed RNRZ-L bit stream to the modulo-2 sum of the outputs of the 14th and 15th stages

Although the RNRZ-L decoder is self-synchronizing, 15 consecutive error-free bits must be loaded into the shift register before the output data will be valid. A bit slip will cause the decoder to lose synchronization, and 15 consecutive error-free data bits must again be loaded into the shift register before the output data is valid. The decoded output data, although correct, will contain the bit slip causing a shift in the data with respect to the frame synchronization pattern. Therefore, frame synchronization must be reacquired before the output provides meaningful data.

The RNRZ-L decoding system has an error multiplication factor of 3 for isolated bit errors (separated from adjacent bit errors by at least 15 bits). An isolated bit error introduced after randomization will produce 3 errors in the output data; the original bit in error, plus two additional errors 14 and 15 bits later. In addition, a burst of errors occurring after the data has been randomized will produce a burst of errors in the derandomized output. The number of errors in the output depends on the distribution of errors in the burst and can be greater than, equal to, or less than the number of errors in the input to the derandomizer; however, the derandomization process always increases the number of bits between the first and last error in the burst by 15. Errors introduced prior to randomization are not affected by either the randomizer or the derandomizer. The reverse decoder has the same bit error properties as the forward decoder.

Input data containing frequent long runs of bits without transitions creates potential dc and low frequency restoration problems in PCM bit synchronizers because of the low frequency cutoff of direct recorder and reproducer systems. The restoration problem can be minimized by reproducing the data at tape speeds that produce a bit rate for which the maximum time between transitions is less than 100 microseconds. Additional methods of minimizing these effects include selecting bit synchronizers containing special dc and low frequency restoration circuitry or recording data using Bi ϕ -L code.

The power spectra of the RNRZ-L and Bi ϕ -L codes are shown below in [Figure A.2-4](#). The power spectral density of RNRZ-L is concentrated at frequencies that are less than one-half the bit rate. The power spectral density of Bi ϕ -L is concentrated at frequencies in a region around 0.75 times the bit rate. The concentration of energy in the low-frequency region (when using the RNRZ-L code) has the effect of reducing the SNR as well as creating baseline wander, which the bit synchronizer must follow. Therefore, reproducing data at tape speeds which produce PCM bit rates of less than 200 kb/s is not recommended when using RNRZ-L unless a bit synchronizer with specially designed dc and low frequency restoration circuitry is available.

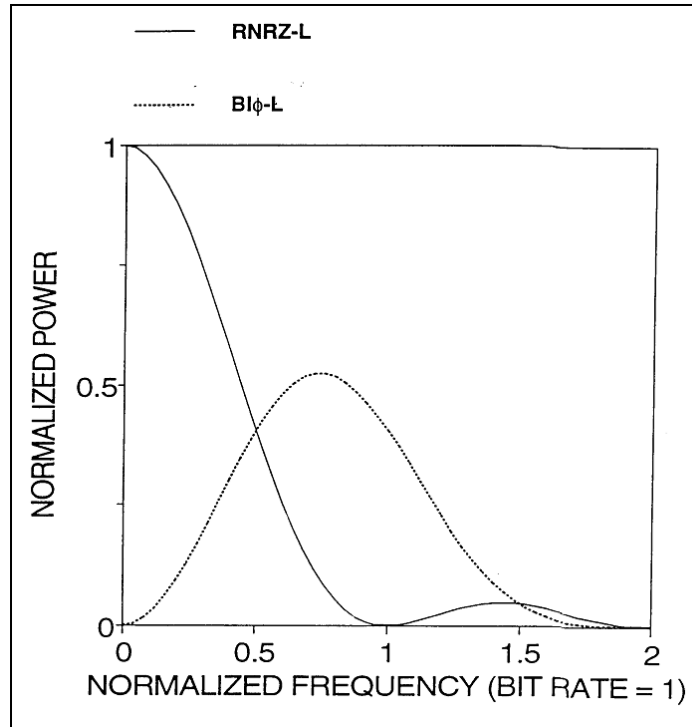

Figure A.2-4. Random PCM power spectra

Alignment of the reproducer system is very important to reproducing high quality PCM data (i.e. data with the lowest possible bit error probability). A PCM signature using the standard 2047-bit pseudo-random pattern, recorded on the leader or the trailer tape, provides a good method for reproducer alignment. When a pseudo-random bit error detection system is not available or when a PCM signature signal is not recorded, the recommended procedure for reproducer alignment involves the use of the eye pattern technique. The eye pattern is the result of superpositioning the zeros and ones in the PCM bit stream. The eye pattern is displayed on an oscilloscope by inserting the raw reproduced bit stream into the vertical input and the reconstructed bit-rate clock into the external synchronization input of the oscilloscope. The reproducer head azimuth, amplitude equalizers, and phase equalizers are then adjusted to produce the eye pattern with the maximum height and width opening.

Sample eye patterns are shown in [Figure A.2-5](#) and [Figure A.2-6](#). [Figure A.2-5](#) shows a Bi ϕ -L eye pattern at a recorded bit packing density of 15 kilobits per inch (kb/in) (450 kb/s at 30 inches per second [in/s]). [Figure A.2-6](#) shows an RNRZ-L eye pattern at a recorded bit packing density of 25 kb/in (750 kb/s at 30 in/s).

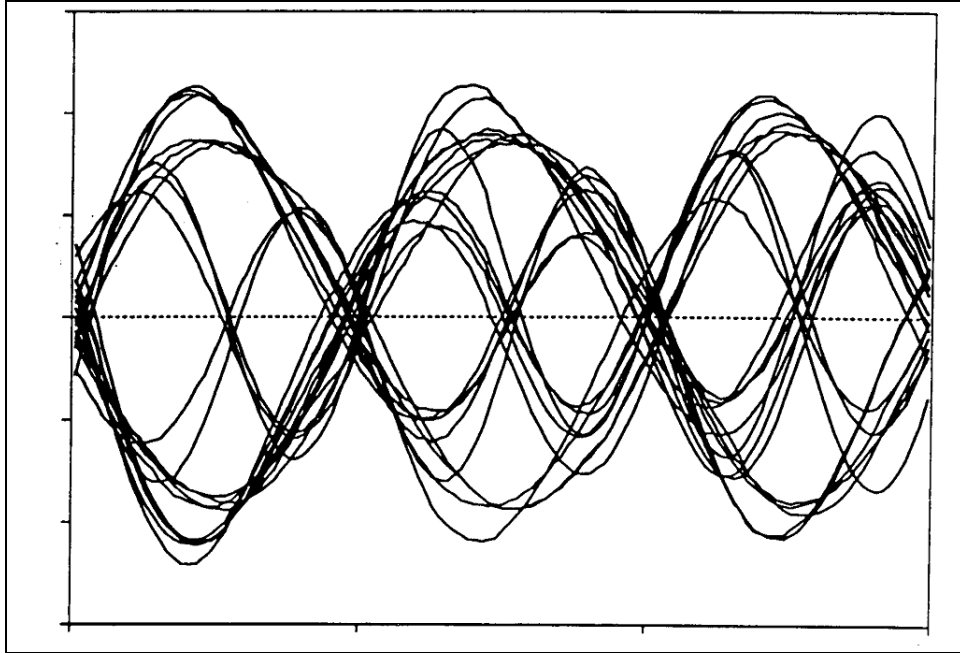

Figure A.2-5. Bi ϕ -L at bit packing density of 15 kb/in

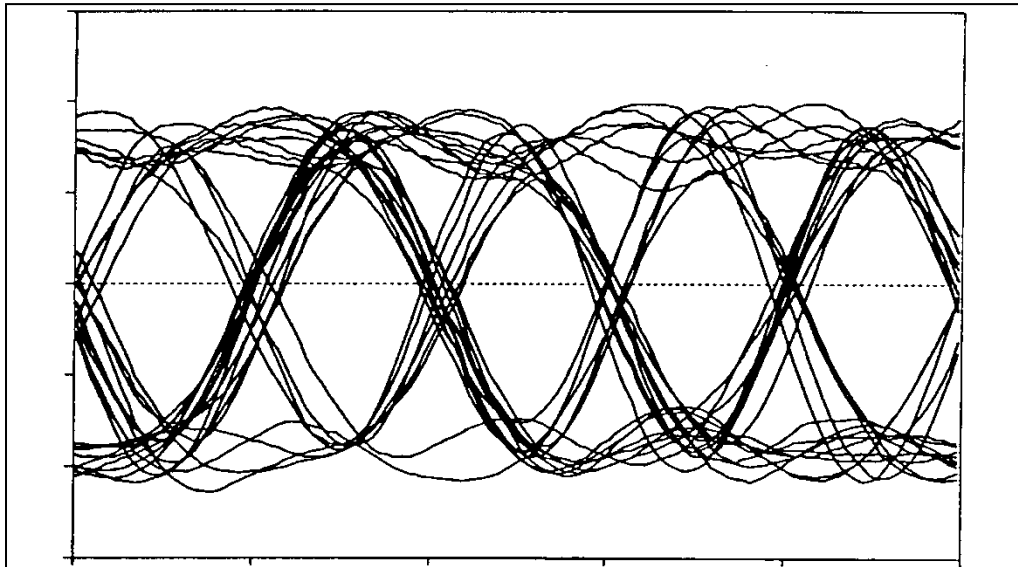

Figure A.2-6. RNRZ-L at bit packing density of 25 kb/in

4. Head Parameters

The following describes the head parameters.

4.1. Gap Scatter

Refer to the definitions in Section 6.2 of [106-11 Chapter 6](#). Gap scatter contains components of azimuth misalignment and deviations from the average line defining the azimuth. Since both components affect data simultaneity from record to reproduce, the gap scatter measurement is the inclusive distance containing the combined errors. Because azimuth

adjustment affects the output of wide-band systems, a 5.08- μm (0.0002-in.) gap scatter is allowed for such recorders and reproducers. A 2.54- μm (0.0001-in.) gap scatter is recommended for fixed-head systems (see [Figure A.2-11](#)).

4.2. Head Polarity

The requirement that a positive pulse at a record amplifier input generate a south-north-north-south magnetic sequence and that a south-north-north-south magnetic sequence on tape produce a positive pulse at the reproduce amplifier output, still leaves two interdependent parameters unspecified. These parameters are (1) polarity inversion or non-inversion in record and playback amplifiers and (2) record or playback head winding sense. For the purpose of head replacement, it is necessary that these parameters be determined by the user so that an unsuspected polarity inversion, on tape or off tape, will not occur after heads are replaced.

5. **Record Level**

The standard record level is established as the input level of a sinusoidal signal set at the record level set frequency which, when recorded, produces a signal containing 1 percent third harmonic distortion at the output of a properly terminated reproduce amplifier (see Subparagraph 5.3.8.2 of Volume III, RCC Document 118¹). A one percent harmonic distortion content is achieved when the level of the third harmonic component of the record level set frequency is 40 ± 1 dB below the level of a sinusoidal signal of 0.3 upper band edge (UBE) which is recorded at the standard record level. Standard test and operating practice is to record and reproduce sinusoidal signals at 0.1 and 0.3 UBE and adjust the equalizers as necessary to establish the reproduced output at 0.3 UBE to within ± 1.0 dB of the output at 0.1 UBE. Then a 1-volt (V) root mean square (rms) signal at the record level set frequency is applied to the record amplifier input and the record and reproduce level controls are adjusted until the reproduced output contains 1 percent third harmonic distortion at a level of 1 V rms.

The optimum level for recording data will seldom be equal to the standard record level. Signals having noise-like spectral distribution such as baseband multiplexes of frequency modulation (FM) subcarriers contain high crest factors so that it may be necessary (as determined in Subparagraph 1.1, Volume IV, RCC Document 118²) to record at levels below the standard record level. On the other hand, for predetection and HDDR recording, signals may have to be recorded above the standard record level to give optimum performance in the data system.

6. **Tape Crossplay Considerations**

[Figure A.2-7](#) illustrates the typical departure from optimum frequency response that may result when crossplaying wide-band tapes that were recorded with heads employing different record-head gap lengths. Line AA is the idealized output-versus-frequency plot of a machine with record bias and record level, set upper IRIG standards, using a 3.05- μm (120-microinch) record-head gap length and a 1.02- μm (40-microinch) reproduce-head gap length. Lines BB and

¹ Range Commanders Council. Test Methods for Recorder and Reproducer Systems and Magnetic Tape. Volume III. RCC 118-99. May be superseded by update. Retrieved 30 June 2020. Available at <https://www.trmc.osd.mil/wiki/x/fou8Bg>

² Range Commanders Council. Test Methods for Telemetry Systems and Subsystems. Volume IV. RCC 118-79. May be superseded by update. Retrieved 30 June 2020. Available at <https://www.trmc.osd.mil/wiki/x/gIu8Bg>

CC represent the output response curves of the same tapes recorded on machines with 5.08- μm (200-microinch) and 1.27- μm (50-microinch) record-head gap lengths. Each of these recorders was set up individually per IRIG requirements. The tapes were then reproduced on the machine having a 1.02- μm (40-microinch) reproduce-head gap length without readjusting its reproduce equalization.

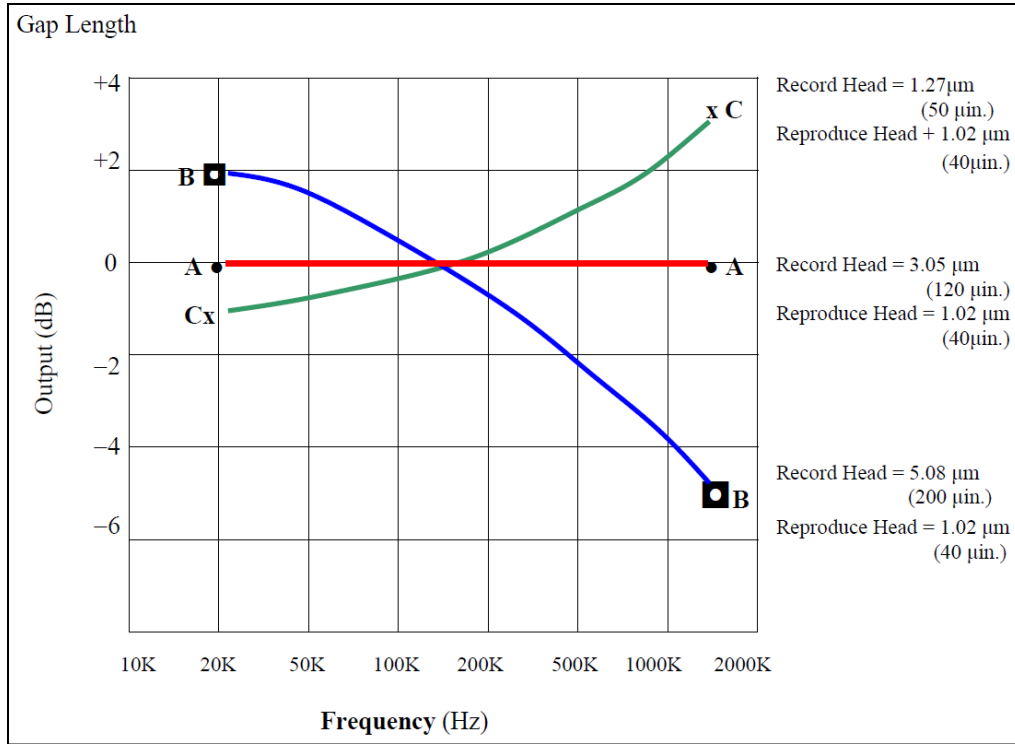

Figure A.2-7. Tape Crossplay

The output curves have been normalized to 0 dB at the 0.1 UBE frequency for the purpose of clarity. The normalized curves may be expected to exhibit a ± 2.0 dB variance in relative output over the passband. The tape recorded with the shortest head segment gap length will provide the greatest relative output at the UBE.

While the examples shown are from older equipment with record gap lengths outside the limits recommended in Subsection [13.4.4](#), they illustrate the importance of the record gap length in tape interchange applications.

7. Standard Tape Signature Procedures

The following describes the recording and playback procedures for the PCM signature and the swept-frequency signature.

7.1. PCM Signature Recording Procedure

Test equipment should be configured as described in Paragraph 2.1, Volume IV, RCC Document 118. The configuration should simulate the operational link as closely as possible to include the same radio frequency, deviation, bit rate, code type, predetection frequency, receiver bandwidth, and recorder speed. The following is the PCM signature recording procedure.

- a. While recording the pseudo-random data at standard record level, adjust the signal generator output level until approximately one error per 10^5 bits is obtained on the error counter.
- b. Record 30 seconds of the pseudo-random data at the beginning or end of the tape for each data track. A separate 30-second tape signature is recommended for each different data format.
- c. The content, track assignments, and location on the tape leader and trailer of signature signals should be noted on the tape label.

7.2. PCM Signature Playback Procedure

The following steps explain the playback procedure.

- a. Optimize playback equipment such as receiver tuning and bit synchronizer setup for data being reproduced.
- b. Reproduce the tape signature and observe the error rate on the error counter.
- c. Optimize head azimuth for maximum signal output and minimum errors.
- d. Initiate corrective action if more than one error per 10^4 bits is obtained.
- e. Repeat for each data track.

7.3. Swept-Frequency Signature Recording Procedure

The following steps describe the recording procedure for the swept-frequency signature.

- a. Patch a sweep-frequency oscillator output to all prime data tracks up to 6 on 7-track recorders or up to 13 on 14-track recorders. As a minimum, patch the sweep oscillator to one odd and one even track.
- b. Connect the sync output of the sweep oscillator to a track not used for sweep signals, preferably an outside track.
- c. Record the signature signals for a minimum of 30 seconds at standard record level.

| | |
|---|---|
|  NOTE | Record levels may be either pre-adjusted or quickly adjusted in all tracks during the first few seconds of the signature recording. |
|---|---|

- d. Note the content, track assignments, and location on the leader or trailer tape of signature signals on the tape label.

7.4. Swept-Frequency Signature Playback Procedure

The following steps define the steps for the playback procedure.

- a. Connect the sync track output of the reproducer to the sync input of the scope.
- b. Select an odd-numbered sweep-signal track and connect the output of the reproducer to the vertical input of the scope. Playback the sweep signal and adjust the scope gain for an amplitude of approximately ± 10 minor vertical divisions about the center baseline. Adjust

the odd-track azimuth for maximum amplitude of the highest frequency segment (extreme right of the sweep pattern).

- c. Observe amplitude variations through the sweep pattern and adjust the equalization, if necessary, to maintain the amplitude within the required tolerance over the required frequency range.

| | |
|---|--|
|  | <p>NOTE A decrease of sweep signal amplitude to about 0.7 represents a 3-dB loss.</p> |
|---|--|

- d. Repeat the playback procedure in the previous two steps for azimuth and equalization adjustments of an even-numbered tape track.
- e. Repeat the procedure in step c for equalization only of other selected prime data tracks, as required.

8. Equipment Required for Swept-Frequency Procedures

Equipment required at the recording site consists of a sweep-frequency oscillator having a constant amplitude sweep range of approximately 400 hertz (Hz) through 4.4 MHz with frequency markers at 62.5, 125, 250, and 500 kilohertz (kHz) and 1.0, 2.0, and 4.0 MHz. The sweep range to 4.4 MHz may be used for all tape speeds because the bandwidth of the recorder and reproducer will attenuate those signal frequencies beyond its range. The sweep rate should be approximately 25 Hz. Care should be exercised in the installation of the sweep generator to ensure a flat response of the sweep signal at the input terminals of the recorder. Appropriate line-driver amplifiers may be required for long cable runs or the low impedance of paralleled inputs.

A stepped-frequency oscillator could be substituted for the sweep-frequency generator at the recording location. Recommended oscillator wavelengths at the mission tape speed are 7.62 mm (300 mils), 3.81 mm (150 mils), 0.254 mm (10 mils), 0.0254 mm (1 mil), 0.0127 mm (0.5 mil), 0.0064 mm (0.25 mil), 0.0032 mm (0.125 mil), 0.0025 mm (0.1 mil), 0.0020 mm (0.08 mil), and 0.0015 mm (0.06 mil).

Equipment required at the playback site consists of an ordinary oscilloscope having a flat frequency response from 400 Hz through 4.4 MHz.

9. Fixed-Frequency Plus White Noise Procedure

The signature used in this method is the same for all applications. For direct recording of subcarrier multiplexes, only static nonlinearity (nonlinearity which is independent of frequency) is important for crosstalk control. Subparagraph [17.2](#) provides a reference level for static nonlinearity. All formats of data recording are sensitive to SNR. Predetection recording and HDDR are sensitive to equalization. The following signature procedure satisfies all the above requirements.

- a. Record a sine-wave frequency of 0.1 UBE (see [Table A.2-6](#)) with the following amplitudes.
 - (1) Equal to the standard record level for direct recording of subcarrier multiplexes and HDDR (see Subparagraph [17.2](#)).

- (2) Equal to the carrier amplitude to be recorded for pre-detection recording of PCM/FM, PCM/PM, FM/FM, and pulse amplitude modulation/FM.
- b. Record flat band-limited white noise of amplitude 0.7 of the true rms value of the 0-dB standard record level as described in Subparagraph [17.2](#). Noise must be limited by a low-pass filter just above the UBE.
- c. Record with zero input (input terminated in 75 ohms). The three record steps previously described can consist of 10 seconds each. The spectra can be obtained with three manually initiated sweeps of less than a second each, because no great frequency resolution is required. All of the spectrum analyzer parameters can be standardized and set in (inputted) prior to running the mission tape.

10. Signature Playback and Analysis

Before analyzing the signature, the reproducer azimuth should be adjusted. With the short signature, it is probably more convenient to use the data part of the recording for this purpose. If predetection recording is used, the azimuth can be adjusted to maximize the output as observed on the spectrum analyzer or on a voltmeter connected to the output. If baseband recording is used, the azimuth can be adjusted to maximize the spectrum at the upper end of the band. A spectrum analyzer should be used to reproduce, store, and photograph the spectra obtained from steps a, b, and c in Section [9](#). The spectrum analyzer input level of zero should be stored and photographed.

It is evident that any maladjustment of the recorder and reproducer or magnetization of the heads will result in the decrease of SNR across the band and will be seen from the stored spectra or photograph.

By having a photograph of the spectra, amplitude equalization can be accomplished without shuttling the mission tape as follows.

- a. Use an auxiliary tape (not the mission tape, but preferably the same type tape). With a white-noise input signal band limited, adjust the amplitude equalization of the recorder and reproducer at the tape dubbing or data reduction site and photograph the output spectrum (see Section [9](#)).
- b. Compare this photo with the photo made from the signature. Note the difference at several points across the band.
- c. Using the auxiliary tape, adjust the amplitude equalization to compensate for the differences noted.
- d. Recheck with the mission tape to verify that the desired amplitude equalization has been achieved.

If the phase equalization is to be checked, a square wave signal can be added to the signature in accordance with the manufacturer's specification (see Volume III, RCC Document 118). The same procedure that is recommended for amplitude equalization can be used, except the procedure is based on oscillograms.

11. Recording and Playback Alignment Procedures

When using standard preamble (or postamble), see Section [21](#).

11.1. Recording of Preamble for Direct Electronics Alignment.

- a. Patch a square wave generator output set to 1/11 band edge to all tracks having direct electronics or initiate procedure for recording internally generated 1/11 band edge square wave according to manufacturer's instructions.
- b. If the preamble will be used for a manual adjustment, record for a minimum of 30 seconds at the standard record level and tape speed to be used for data recording.
- c. If the preamble will be used only for automatic alignment, record at the standard record level and tape speed to be used for data recording for a sufficient time as specified by the manufacturer of the playback recorder reproducer or as agreed by the interchange parties.

11.2. Playback of Preamble for Direct Electronics Alignment.

For systems so equipped, initiate automatic alignment procedure per manufacturer's instructions. The procedure for manual adjustment is described in the following steps.

- a. Display fundamental and odd harmonics of the square wave (third through eleventh) of selected odd numbered direct track near center of head stack on the spectrum analyzer. Adjust azimuth by peaking output amplitude of the third through eleventh harmonic. Final adjustment should peak the eleventh harmonic.
- b. Repeat step a for even numbered direct track. (Only one track is necessary for a double-density, 14-track, in-line system.)
- c. Observe frequency response across the band pass on selected track and correct if necessary. For a flat response, the third harmonic will be 1/3 of the amplitude of the fundamental, fifth harmonic 1/5 the amplitude, and so on. A convenient method is to compare the recorder/reproducer output with that of a square wave generator patched directly to the spectrum analyzer.

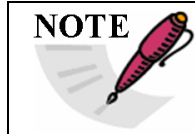

NOTE

An alternate, but less accurate, method is to optimize the square wave as displayed on an oscilloscope rather than a spectrum analyzer.

- d. Repeat step c for each direct track.
- e. Display square wave on an oscilloscope. Adjust phase for best square wave response as shown in [Figure A.2-8](#).
- f. Repeat step e for each direct track.

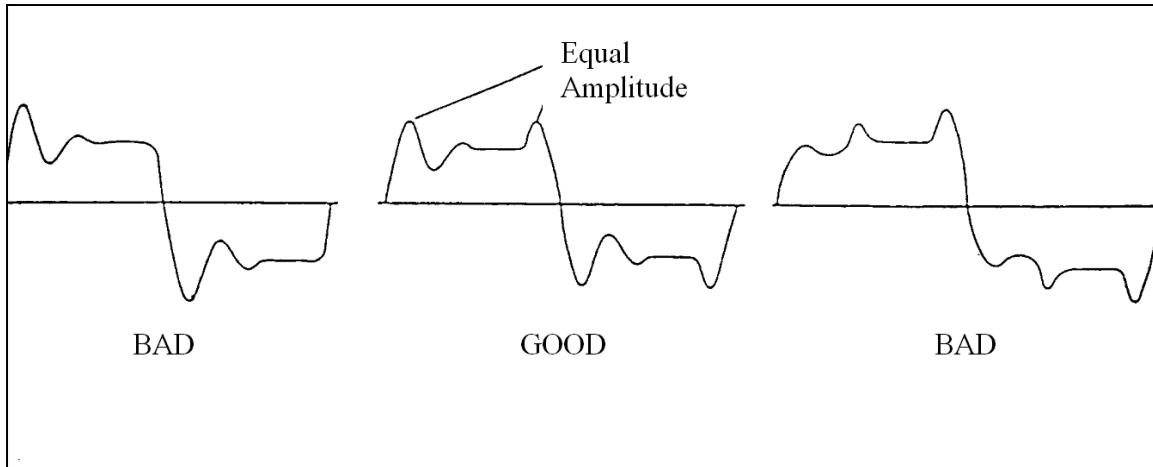

Figure A.2-8. Square wave responses

11.3. Recording of Preamble for FM Electronics Alignment

If available, initiate the procedure for recording internally generated 1/11 band edge square wave and ± 1.414 Vdc per manufacturer's instructions. Otherwise, patch a square wave generator output to all tracks having FM electronics. A near dc signal may be obtained by setting the square wave generator to 0.05 Hz and ± 1.414 V or by using a separate dc source.

- a. If the preamble will be used for manual alignment, record at least one cycle of the 0.05 Hz square wave at ± 1.414 V or a positive and negative 1.414 Vdc for a minimum of 10 seconds each at the tape speed to be used for data recording. Next, record a 1/11 band edge square wave for a minimum of 20 seconds.
- b. If the preamble will be used only for automatic alignment, record the above sequence for a sufficient time as specified by the manufacturer of the playback recorder/reproducer or as agreed by the interchange parties.

11.4. Playback of Preamble for FM Electronics Alignment

For systems so equipped, initiate automatic alignment procedure per manufacturer's instructions. The procedure for manual adjustment is described in the next steps.

- a. Check and adjust for 0-V output at center frequency per RCC Document 118, Test Methods for Telemetry Systems and Subsystems, Volume III, Test Methods for Recorder/Reproducer Systems and Magnetic Tape.
- b. Use dc voltmeter to verify a full positive and negative output voltage on the selected track and correct if necessary.
- c. Display fundamental and odd harmonics of the square wave (third through eleventh) on the spectrum analyzer.
- d. Observe frequency response per step c in Subsection [11.2](#).
- e. Repeat steps a through c for each FM track.

12. General Considerations for Longitudinal Recording

Standard recording techniques, tape speeds, and tape configurations are required to provide maximum interchange of recorded telemetry magnetic tapes between the test ranges. Any one of the following methods of information storage or any compatible combination may be used simultaneously: direct recording, predetection recording, FM recording, or PCM recording. Double-density recording may be used when the length of recording time is critical; however, it must be used realizing that performance parameters such as SNR, crosstalk, and dropouts may be degraded (see Section 2).

12.1. Tape Speeds

The standard tape speeds for instrumentation magnetic tape recorders are shown in [Table A.2-4](#).

12.2. Tape Width

The standard nominal tape width is 25.4 mm (1 in.) (see [Table A.2-17](#)).

12.3. Record and Reproduce Bandwidths

For the purpose of these standards, two system bandwidth classes are designated: wide band and double density (see [Table A.2-4](#)). Interchange of tapes between the bandwidth classes is NOT recommended.

13. Recorded Tape Format

The parameters related to recorded tape format and record and reproduce head configurations determine compatibility between systems that are vital to interchangeability (crossplay) of recorded magnetic tapes. Refer to the definitions in Section 6.2 [Chapter 6](#), [Figure A.2-9](#), [Figure A.2-10](#), and [Figure A.2-11](#). Refer also to [Table A.2-5](#), [Table A.2-6](#), [Table A.2-7](#), and [Figure A.2-12](#).

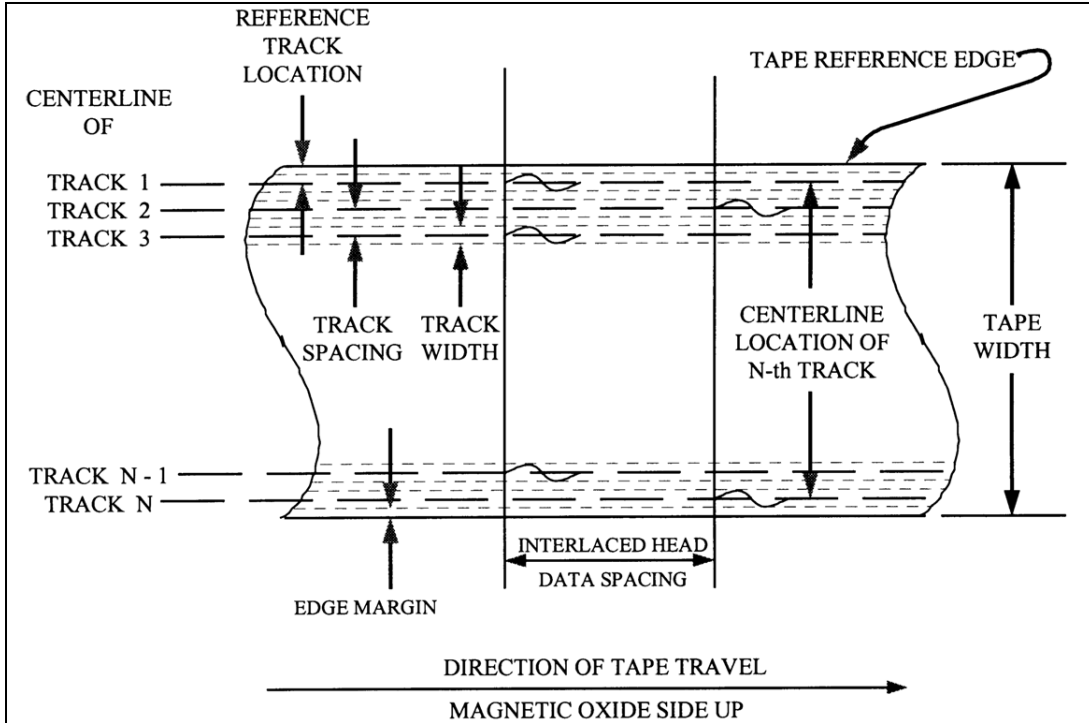

Figure A.2-9. Recorded tape format

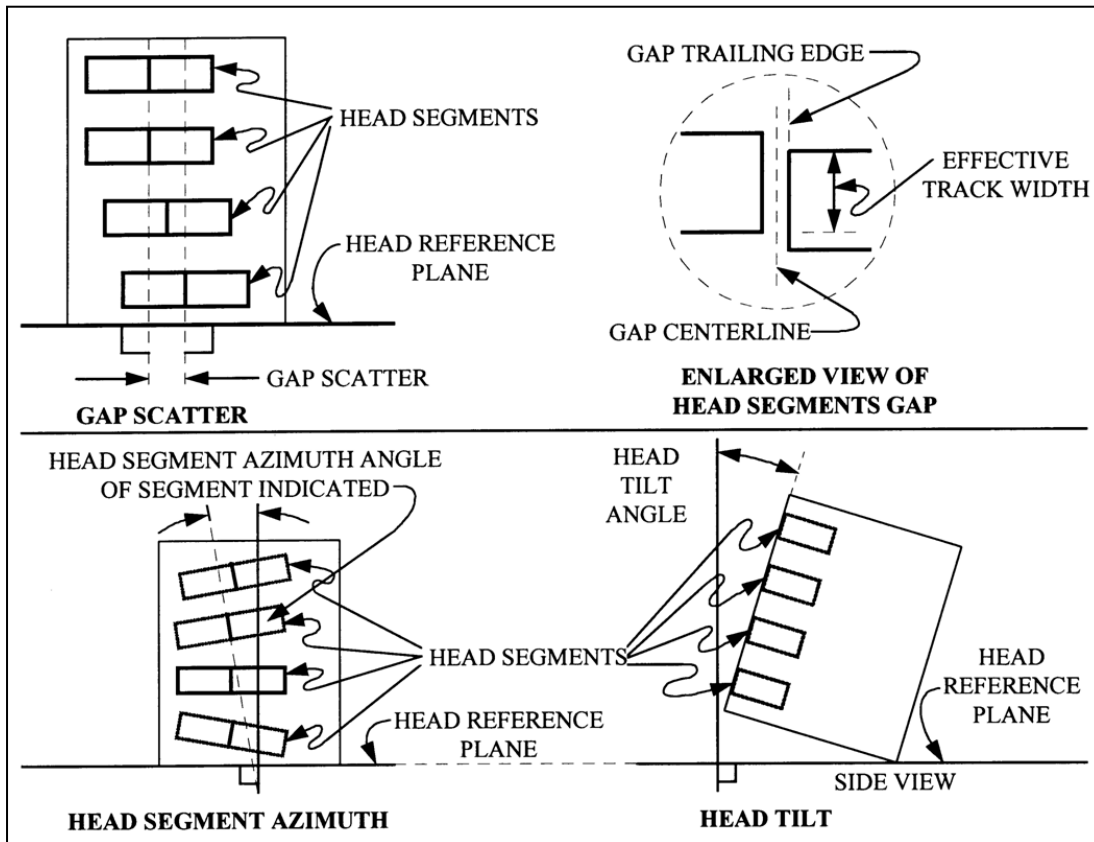

Figure A.2-10. Head and head segment mechanical parameters

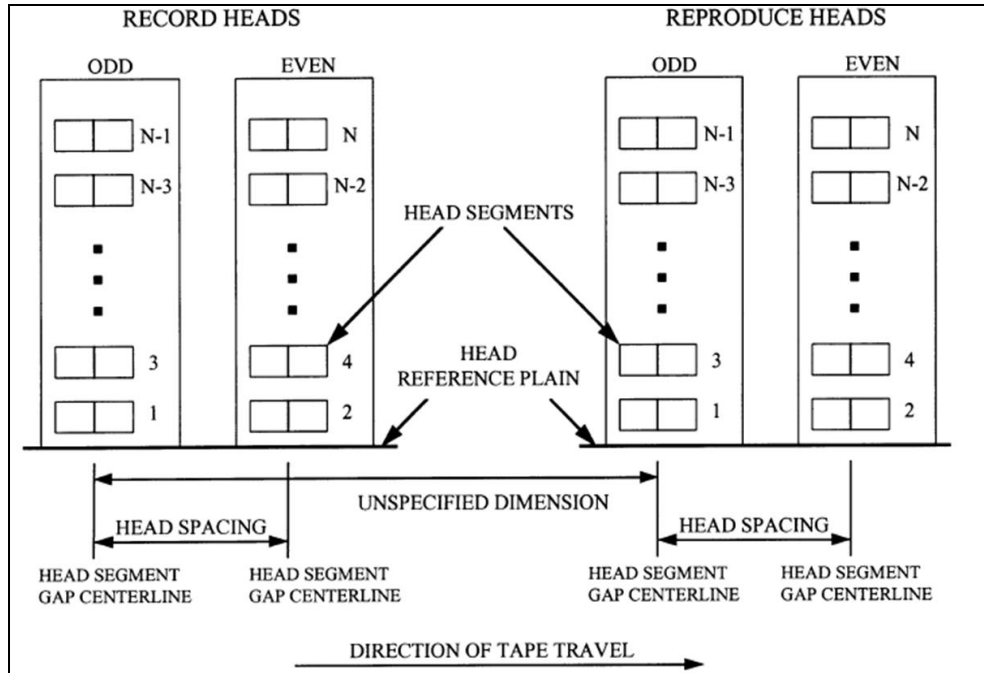

Figure A.2-11 Record and reproduce head and head segment identification and location (N-track interlaced system)

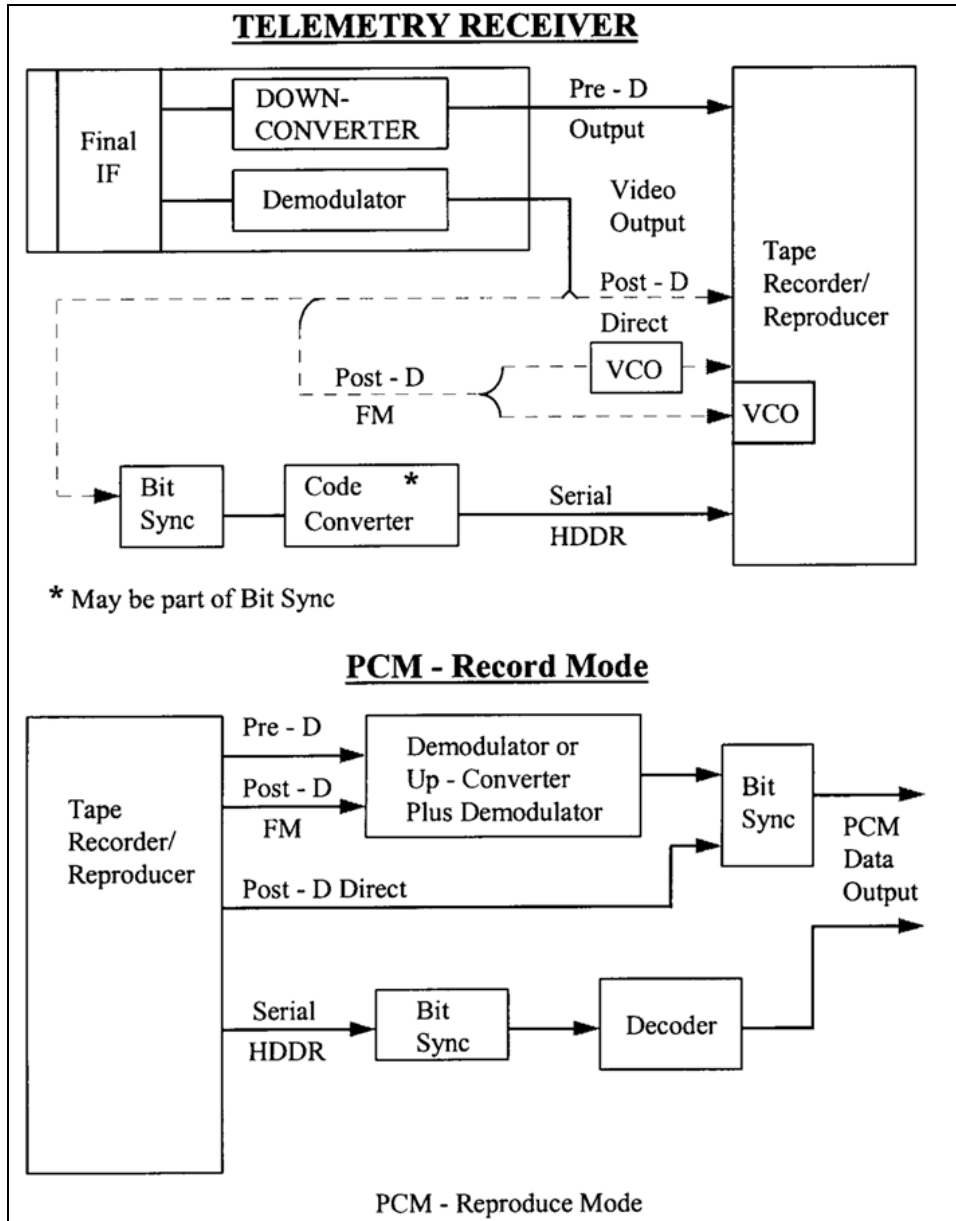

Figure A.2-12. PCM record and reproduce configuration

13.1. Track Width and Spacing

Refer to [Figure A.2-11](#), [Table A.2-5](#), [Table A.2-6](#), and [Table A.2-7](#).

13.2. Track Numbering

The tracks on a tape are numbered consecutively from track 1 through track n with track 1 located nearest the tape reference edge as shown in [Figure A.2-9](#).

13.3. Data Spacing

For interlaced formats, the spacing on tape between simultaneous events on odd and even tracks is nominally 38.1 mm (1.5 in). See Subparagraph [13.4.1](#).

13.4. Head Placement

The standard technique for wide band and 28-track double density is to interlace the heads, both the record and the reproduce, and to provide alternate tracks in separate heads. Thus, to record on all tracks of a standard width tape, two interlaced record heads are used. To reproduce all tracks of a standard width tape, two interlaced reproduce heads are used. For 14-track double density, the standard technique uses one in-line record head and one in-line reproduce head.

13.4.1. Head Placement, Interlaced

Two heads comprise the record-head pair or the reproduce-head pair. Mounting of either head pair is done in such a manner that the center lines drawn through the head gaps are parallel and spaced 38.10 mm \pm 0.05 (1.500 in. \pm 0.002) apart, as shown in [Table A.2-5](#) and [Table A.2-7](#), for systems that include head azimuth adjustment. The dimension between gap centerlines includes the maximum azimuth adjustment required to meet system performance requirements. For systems with fixed heads (i.e., heads without an azimuth adjustment), the spacing between gap centerlines shall be 38.10 mm \pm 0.03 (1.500 in. \pm 0.001) (see [Figure A.2-10](#)).

13.4.2. Head Identification and Location

A head segment is numbered to correspond to the track number that segment records or reproduces. Tracks 1, 3, 5, ... are referred to as the "odd" head segments. Tracks 2, 4, 6, ... are referred to as the even head segments. For interlaced heads, the head containing the odd numbered segments (odd head) is the first head in a pair of heads (record or reproduce) over which an element of tape passes when moving in the forward record or reproduce direction (see Figure 6-2 of 106-11 [Chapter 6](#)).

13.4.3. In-Line Head Placement

An in-line head shall occupy the position of head number 1 in an interlaced system.

13.4.4. Head Segment Location

Any head segment within a head shall be located within \pm 0.05 mm (\pm 0.002 in.) of the nominal (dimension from table without tolerances) position required to match the track location as shown in [Figure A.2-11](#), [Table A.2-5](#), [Table A.2-6](#), and [Table A.2-7](#).

| Table A.2-4. Record and Reproduce Parameters | | | | |
|---|-------|--|---|-------------------------------------|
| Tape Speed | | \pm 3 dB Reproduce Passband kHz ⁽¹⁾ | Direct Record Bias Set Frequency (UBE) kHz ⁽²⁾ | Level Set Frequency 10% of UBE, kHz |
| mm/s | in/s | | | |
| Wide Band | | | Overbias 2dB | |
| 6096.0 | 240 | 0.8-4000 | 4000 | 400 |
| 3048.0 | 120 | 0.4-2000 | 2000 | 200 |
| 1524.0 | 60 | 0.4-1000 | 1000 | 100 |
| 762.0 | 30 | 0.4-500 | 500 | 50 |
| 381.0 | 15 | 0.4- | 250 | 25 |
| 190.5 | 7-1/2 | 0.4-5 | 125 | 12.5 |
| 95.2 | 3-3/4 | 0.4-2.5 | 62.5 | 6.25 |
| 47.6 | 1-7/8 | 0.4-31.25 | 31.25 | 3.12 |

| Double Density | | | Overbias 2 dB | |
|----------------|-------|---------|---------------|------|
| 3048.0 | 120 | 2-4000 | 4000 | 400 |
| 1524.0 | 60 | 2-2000 | 2000 | 200 |
| 762.0 | 30 | 2-1000 | 1000 | 100 |
| 381.0 | 15 | 2-500 | 500 | 50 |
| 190.0 | 7-1/2 | 1-250 | 250 | 25 |
| 95.2 | 3-3/4 | 0.5-125 | 125 | 12.5 |

Notes:

1. Passband response reference is the output amplitude of a sinusoidal signal at the record level set frequency recorded at standard record level. The record level set frequency is ten percent of the upper band edge frequency (0.1 UBE).
2. When setting record bias level, a UBE frequency input signal is employed. The signal input level is set 5 to 6 dB below standard record level to avoid saturation effects which could result in erroneous bias level settings. The record bias current is adjusted for maximum reproduce output level and then increased until the output level decreases by the number of dB indicated in the table (see Subparagraph 5.3.8.1 of Volume III, RCC Document 118).

| Table A.2-5. Dimensions - Recorded Tape Format - 14 Tracks Interlaced on 25.4 mm (1 inch) Wide Tape⁽¹⁾ | | |
|--|----------------------------|---------------|
| Parameters | Millimeters | Inches |
| Track Width | 1.397 (Min); 1.143 (Max) | 0.050 ±0.005 |
| Track Spacing | 1.778 | 0.070 |
| Fixed Head Spacing | 38.075 (Max); 38.125 (Min) | 1.500 ±0.001 |
| Adjustable Head Spacing | 38.151 (Max); 38.049 (Min) | 1.500 ±0.002 |
| Edge Margin, Minimum | 0.279 | 1.011 |
| Reference Track Location | 1.168 (Max); 1.067 (Min) | 0.044 ±0.002 |
| Track Location Tolerance | 0.051 (Max); -0.051 (Min) | ±0.002 |
| Location of nth Track | | |
| Track Number | Millimeters | Inches |
| 1 (Reference) | 0.000 | 0.000 |
| 2 | 1.829 (Max); 1.727 (Min) | 0.070 |
| 3 | 3.607 (Max); 3.505 (Min) | 0.140 |
| 4 | 5.385 (Max); 5.283 (Min) | 0.210 |
| 5 | 7.163 (Max); 7.061 (Min) | 0.280 |
| 6 | 8.941 (Max); 8.839 (Min) | 0.350 |
| 7 | 10.719 (Max); 10.617 (Min) | 0.420 |
| 8 | 12.497 (Max); 12.395 (Min) | 0.490 |
| 9 | 14.275 (Max); 14.173 (Min) | 0.560 |
| 10 | 16.053 (Max); 15.951 (Min) | 0.630 |
| 11 | 17.831 (Max); 17.729 (Min) | 0.700 |
| 12 | 19.609 (Max); 19.507 (Min) | 0.770 |
| 13 | 21.387 (Max); 21.285 (Min) | 0.840 |

| | | |
|---|----------------------------|-------|
| 14 | 23.165 (Max); 23.063 (Min) | 0.910 |
| Note 1. Refer to Figure A.2-9 . | | |

| Table A.2-6. Dimensions - Recorded Tape Format - 14 Tracks In-Line On 25.4 mm (1 inch) Wide Tape⁽¹⁾ | | |
|---|----------------------------|----------------|
| Parameters | Millimeters | Inches |
| Track Width | 0.660 (Max); 0.610 (Min) | 0.25 ±0.001 |
| Track Spacing | 1.778 | 0.070 |
| Edge Margin, Minimum ⁽²⁾ | 1.118 (Max); 0.044 (Min) | |
| Reference Track Location | 0.698 (Max); 0.622 (Min) | 0.0260 ±0.0015 |
| Track Location Tolerance | 0.038 (Max); -0.038 (Min) | ±0.0015 |
| Location of nth track | | |
| Track Number | Millimeters | Inches |
| 1 (Reference) | 0.000 | 0.000 |
| 2 | 1.816 (Max); 1.740 (Min) | 0.070 |
| 3 | 3.594 (Max); 3.518 (Min) | 0.140 |
| 4 | 5.372 (Max); 5.296 (Min) | 0.210 |
| 5 | 7.150 (Max); 7.074 (Min) | 0.280 |
| 6 | 8.928 (Max); 8.852 (Min) | 0.350 |
| 7 | 10.706 (Max); 10.630 (Min) | 0.420 |
| 8 | 12.484 (Max); 12.408 (Min) | 0.490 |
| 9 | 14.262 (Max); 14.186 (Min) | 0.560 |
| 10 | 16.040 (Max); 15.964 (Min) | 0.630 |
| 11 | 17.818 (Max); 17.742 (Min) | 0.700 |
| 12 | 19.596 (Max); 19.520 (Min) | 0.770 |
| 13 | 21.374 (Max); 21.298 (Min) | 0.840 |
| 14 | 23.152 (Max); 23.076 (Min) | 0.910 |
| Notes: | | |
| 1. Refer to Figure A.2-9 . | | |
| 2. Track location and spacing are the same as the odd tracks of the 28-track interlaced format (see Table A.2-7). The minimum edge margin for track 1 is only 0.044 mm (0.009 inch). | | |

| Table A.2-7. Dimensions - Recorded Tape Format - 14 Tracks Interlaced On 25.4 mm (1 inch) Wide Tape⁽¹⁾ | | |
|--|----------------------------|----------------|
| Parameters | Millimeters | Inches |
| Track Width | 0.660 (Max); 0.610 (Min) | 0.25 ±0.001 |
| Track Spacing | 0.889 | 0.035 |
| Fixed Head Spacing | 38.125 (Max); 38.075 (Min) | 1.500 ±0.001 |
| Adjustable Head Spacing | 38.151 (Max); 38.049 (Min) | 1.500 ±0.002 |
| Edge Margin, Minimum ⁽²⁾ | 0.229 | 1.009 |
| Reference Track Location | 0.699 (Max); 0.622 (Min) | 0.0260 ±0.0015 |

| Track Location Tolerance | 0.038 (Max); -0.038 (Min) | ±0.0015 |
|--|----------------------------|---------|
| Location of n th Track | | |
| Track Number | Millimeters | Inches |
| 1 (Reference) | 0.000 | 0.000 |
| 2 | 0.927 (Max); 0.851 (Min) | 0.035 |
| 3 | 1.816 (Max); 1.740 (Min) | 0.170 |
| 4 | 2.705 (Max); 2.629 (Min) | 0.105 |
| 5 | 3.594 (Max); 3.518 (Min) | 0.140 |
| 6 | 4.483 (Max); 4.407 (Min) | 0.175 |
| 7 | 5.372 (Max); 5.296 (Min) | 0.210 |
| 8 | 6.261 (Max); 6.185 (Min) | 0.245 |
| 9 | 7.150 (Max); 7.074 (Min) | 0.280 |
| 10 | 8.039 (Max); 7.963 (Min) | 0.315 |
| 11 | 8.928 (Max); 8.852 (Min) | 0.350 |
| 12 | 9.817 (Max); 9.741 (Min) | 0.385 |
| 13 | 10.706 (Max); 10.630 (Min) | 0.420 |
| 14 | 11.595 (Max); 11.519 (Min) | 0.455 |
| 15 | 12.484 (Max); 12.408 (Min) | 0.490 |
| 16 | 13.373 (Max); 13.297 (Min) | 0.525 |
| 17 | 14.262 (Max); 14.186 (Min) | 0.560 |
| 18 | 15.151 (Max); 15.075 (Min) | 0.595 |
| 19 | 16.040 (Max); 15.964 (Min) | 0.630 |
| 20 | 16.929 (Max); 16.853 (Min) | 0.665 |
| 21 | 17.818 (Max); 17.742 (Min) | 0.700 |
| 22 | 18.707 (Max); 18.631 (Min) | 0.735 |
| 23 | 19.596 (Max); 19.520 (Min) | 0.770 |
| 24 | 20.485 (Max); 20.409 (Min) | 0.805 |
| 25 | 21.374 (Max); 21.298 (Min) | 0.840 |
| 26 | 22.263 (Max); 22.187 (Min) | 0.875 |
| 27 | 23.152 (Max); 23.076 (Min) | 0.910 |
| 28 | 24.041 (Max); 23.965 (Min) | 0.945 |
| Notes: | | |
| 1. Refer to Figure A.2-9 . | | |
| 2. Track location and spacing for the odd tracks are same as the tracks of the 14-track inline format (see Table A.2-6). Edge margin for track 1 is only 0.229 mm (0.009 in). | | |

14. Head and Head Segment Mechanical Parameters

The following describes the mechanical parameters of the head and head segments.

14.1. Gap Scatter

Gap scatter shall be 0.005 mm (0.0002 in.) or less for 25.4 mm (1 in.) tape (see [Figure A.2-11](#) and Subparagraph [4.1](#)).

14.2. Head Segment Gap Azimuth Alignment

The head segment gap azimuth shall be perpendicular to the head reference plane to within ± 0.29 mrad (± 1 minute of arc).

14.3. Head Tilt

The plane tangent to the front surface of the head at the center line of the head segment gaps shall be perpendicular to the head reference plane within ± 0.29 mrad (± 1 minute of arc) for wide-band and double-density recorders (see [Figure A.2-11](#)).

14.4. Record-Head Segment Gap Parameters

The parameters for the length and azimuth alignment are described in the following subparagraphs.

14.4.1. Record-Head Segment Gap Length

The record gap length (the perpendicular dimension from the leading edge to the trailing edge of the gap) shall be $2.16 \mu\text{m} \pm 0.5$ (85 microinch ± 20) for wide-band recorders and $0.89 \mu\text{m} \pm 0.12$ (35 microinch ± 5) for double-density recorders (see Figure 6-3 of [Chapter 6](#) and Section [6](#)).

14.4.2. Record-Head Stack Gap Azimuth Alignment

The record-head stack azimuth shall be perpendicular to the head reference surface to within ± 0.29 mrad (± 1 minute of arc). See Subparagraph 1.2, Volume III, RCC Document 118 for suggested test procedure.

14.4.3. Reproduce-Head Segment Gap Azimuth Alignment

The reproduce-head segment azimuth alignment shall match that of the record-head segment as indicated by reproducing a UBE frequency signal on a selected track and setting the reproduce head azimuth for the maximum output. At this azimuth setting, the output of any other track in the reproduce head shall be within 2 dB of the output at its own optimum azimuth setting (see Subparagraph 1.3, Volume III, RCC Document 118).

15. **Head Polarity**

Also refer to Chapter 1, Volume III, RCC Document 118 and Subparagraph [4.2](#) herein.

15.1. Record-Head Segment

Each record-head winding shall be connected to its respective amplifier in such a manner that a positive going pulse referenced to system ground at the record amplifier input will result in the generation of a specific magnetic pattern on a segment of tape passing the record head in the normal direction of tape motion. The resulting magnetic pattern shall consist of a polarity sequence of south-north-north-south.

15.2. Reproduce-Head Segment

Each reproduce-head segment winding shall be connected to its respective amplifier in such a manner that an area of a tape track exhibiting a south-north-north-south magnetic pattern will produce a positive going pulse with respect to system ground at the output of the reproducer amplifier.

16. Magnetic Tape and Reel Characteristics

It is recommended that all recorder and reproducer systems at a particular test range be calibrated for operational use against a reference tape of the type used by the range for each bandwidth class of recorder and reproducer system. Additional supplementary procurement specifications may be required to meet a particular operational requirement of the ranges.

16.1. Tape Width

The standard nominal tape width is 25.4 mm (1 in.) (see Section 25 and [Table A.2-17](#)).

16.2. Tape Guiding

The tape guidance system restricts the tape angular motion to ± 0.15 mrad (± 30 seconds of arc) as measured by the interchannel time displacement error of outer tracks on the same head stack. Make sure the guidance system does not damage the tape.

17. Direct Record and Reproduce Systems

Direct recording is a method of recording information signals on magnetic tape using high-frequency ac bias recording (see definitions at Section 6.2 of [106-11 Chapter 6](#)). Two classes of systems, wide band and double density, are included in these standards (see [Table A.2-4](#)).

17.1. Direct Record Parameters

The following items describe the direct record parameters.

- a. The input impedance for wide-band and double-density recorders shall be 75 ohms nominal across the specified band.
- b. Input gain adjustment shall be provided to permit sine-wave signals of 0.35 to 3.5 V rms to be adjusted to produce standard record level.
- c. Ideally, the recorded flux level on tape versus frequency should be constant. To approach this ideal, the record amplifier transfer characteristic is basically a constant current versus frequency with a superimposed compensation characteristic to correct only for loss of recording efficiency with frequency. Results of the test described in Subparagraph 1.8 Volume III, RCC Document 118, with the output amplitude at the 2 percent UBE frequency used as the 0 dB reference, shall be no greater than the level identified in [Table A.2-8](#).

| Table A.2-8. Upper Band Edge Maximum Level | |
|---|----------------------|
| Percent of UBE Frequency | dB Difference |
| 10 | 0.5 |
| 50 | 1.0 |
| 80 | 1.6 |
| 100 | 2.0 |

- d. Record bias setting information is contained in [Table A.2-4](#). The bias frequency shall be greater than 3.5 times the highest direct record frequency for which the recorder and reproducer system is designed.

17.2. Standard Record Level

The standard record level for direct record systems is the input level of the record level set frequency, which produces an output signal containing one percent third harmonic distortion. The conditions necessary to establish the standard record level include appropriate selection of the sinusoidal reference frequency (record level set frequency) as indicated in [Table A.2-4](#) and proper reproduce amplifier termination as defined in Figure 1-10 Volume III, RCC Document 118. A one percent third-harmonic distortion content is achieved when the level of the third harmonic of the record level set frequency is 40 dB \pm 1 below the level of a sinusoidal signal of 30 percent of UBE frequency which is recorded at the standard record level (see Section [5](#) for information regarding standard test and operating practices).

17.3. Reproduce Parameters

The following items describe the reproduce parameters.

- a. For wide-band and double-density recorders, the output impedance shall be 75 ohms nominal across the specified passband.
- b. When reproducing a signal at the record level set frequency (recorded at the standard record level), the output level shall be a minimum of 1 V rms with a third harmonic distortion of 1 percent and a maximum second harmonic distortion of 0.5 percent when measured across a resistive load of 75 ohms. Lack of proper output termination will not cause the reproduce amplifier to oscillate.

17.4. Tape Speed and Flutter Compensation

The average or long-term tape speed must be the same during record and reproduce to avoid frequency offsets, which may result in erroneous data. To minimize this problem, a reference signal may be applied to the tape during record and the signal used to servo-control the tape speed upon reproduce; however, because servo-control systems have limited correction capabilities and to minimize the amount of equipment required at the ranges, tape speeds and servo-control signals shall conform to the following standards.

- a. The effective tape speed throughout the reel or any portion of the reel (in absence of tape-derived servo-speed control) shall be within \pm 0.2 percent of the standard speed as measured by the procedures described in Chapter 1, Volume III, RCC Document 118.
- b. Sinusoidal or square wave speed control signals are recorded on the tape for the purpose of servo-control of tape speed during playback. The operating level for speed-control signals shall be 10 dB \pm 5 below standard record level when mixed with other signals or standard record level when recorded on a separate track.
- c. The constant-amplitude speed-control signal shall be used on a separate track for optimum servo-speed correction. The speed-control signal may be mixed with other signals if recording requirements so demand and system performance permits. Mixing of the speed-control signal with certain types of signals may degrade system performance

for tapes which are to be reproduced on tape transports with low time-base error capstan drive systems (refer to manufacturer). [Table A.2-9](#) lists speed-control signal frequencies. The speed-control signal may also be used as a flutter correction signal.

- d. Signals to be used for discriminator flutter correction systems are listed in [Chapter 3](#), Table 3-5 and [Table A.2-9](#). See the previous step and [Chapter 3](#), Table 3-5 for restrictions on use of flutter correction signals.

| Table A.2-9. Constant Amplitude Speed Control Signals⁽¹⁾ | | | |
|--|--------|--------------------------------|------------|
| Tape Speed | | Frequency ⁽²⁾ (kHz) | |
| (mm/s) | (in/s) | | |
| 6096 | 240 | 400±0.01% | 800±0.01% |
| 3048 | 120 | 200±0.01% | 400±0.01% |
| 1524 | 60 | 100±0.01% | 200±0.01% |
| 762 | 30 | 50±0.01% | 100±0.01% |
| 381 | 15 | 25±0.01% | 50±0.01% |
| 190.5 | 7-1/2 | 12.5±0.01% | 25±0.01% |
| 95.5 | 3-3/4 | 6.5±0.01% | 12.5±0.01% |
| 47.6 | 1-7/8 | 3.125±0.01% | 6.25±0.01% |

Notes:

1. May also serve as discriminator flutter-correction reference signal (see [Chapter 3](#), Table 3-5).
2. Either set of speed-control signals may be used primarily with wideband systems, but only the higher set of frequencies is recommended for double-density systems. When interchanging tapes, care should be taken to ensure that the recorded speed-control signal is compatible with the reproduce system's speed-control electronics.

18. Timing, Predetection, and Tape Signature Recording

Described in the following subparagraphs are timing signal, predetection, and tape signature recording.

18.1. Timing Signal Recording

Modulated-carrier, time-code signals (IRIG A, IRIG B, and IRIG G) are widely used and other formats are available. When recording IRIG B time-code signals, care must be taken to ensure that low-frequency response to 100 Hz is provided. The direct record, low frequency cutoff of most wide-band recorders is 400 to 800 Hz. For these systems, IRIG B time code signals should be recorded on an FM track or on an FM subcarrier. The widest bandwidth subcarrier available should be employed to minimize time delay.³ For double-density systems, all time code signals should be recorded on an FM track or an FM subcarrier.

³ Timing code formats are found in IRIG standard 200-16, IRIG Serial Time Formats and IRIG standard 205-87, Parallel Binary and Parallel Binary Coded Decimal Time Code Formats.

18.2. Predetection Recording

Predetection signals have been translated in frequency but not demodulated. These signals will be recorded by direct (high frequency bias) recording. Parameters for these signals are in [Table A.2-10](#).

| Table A.2-10. Predetection Carrier Parameters | | | | | |
|--|-------|----------------|-------|--|---------|
| Tape Speed | | | | Predetection Carrier Center Frequency^(1,2) | |
| Wide Band | | Double Density | | A (kHz) | B (kHz) |
| mm/s | in/s | mm/s | in/s | | |
| 6096 | (240) | 3048.0 | (120) | 1800 | 2400 |
| 3048 | (120) | 1524.0 | (60) | 900 | 1200 |
| 1524 | (60) | 762.0 | (30) | 450.0 | 600 |
| 762 | (30) | 381.0 | (15) | 225.0 | 300 |
| 381 | (15) | 109.5 | (7.5) | 112.5 | 150 |

Notes:
 1. The predetection record/playback passband is the carrier center frequency ± 66.7 percent.
 2. Use center frequencies in column B when data bandwidth exceeds the capabilities of those in column A.

18.3. Tape Signature Recording

For data processing using wide-band and double-density recorders and reproducers, a tape signature recorded before or after the data, or both before and after the data, provides a method of adjusting the reproducer head azimuth and reproduce equalization. A means is also provided for verifying the proper operation of equipment such as playback receivers and bit synchronizers used to retrieve the recorded data.

A PCM signature is recommended where primarily PCM data is recorded. A swept-frequency or white-noise signature may be used for other data such as frequency division multiplexing or wide band FM. The procedures for recording and using these signatures are given in Section [22](#). A recommended preamble/postamble signal for recorder/reproducer alignment is included in Paragraph [21](#).

| | |
|--|--|
|  <p>NOTE</p> | <p>Caution should be used when multiplexing other signals with the speed-control signal. In the vicinity of the frequency of the speed-control signal ($f_{sc} \pm 10$ percent), the level of individual extraneous signals including spurious, harmonics, and noise must be 40 dB or more below the level of the speed-control signal. A better procedure is to leave one octave on either side of the speed-control signal free of other signals.</p> |
|--|--|

19. **FM Record Systems**

For these FM record systems, the input signal modulates a voltage-controlled oscillator, and the output is delivered to the recording head. High frequency bias may be used but is not required. These standards shall apply.

- a. Tape and Reel Characteristics. Section [22](#) and all related subparagraphs shall apply.

- b. Tape Speeds and Corresponding FM Carrier Frequencies. See [Table A.2-11](#).
- c. FM Record/Reproduce Parameters. See [Table A.2-11](#).

| Table A.2-11. Wide-band and Double-Density FM Record Parameters | | | | | | | | |
|--|-------|--------------------------|---|-----------------|----------------------|----------------------|--------------|--------|
| Tape Speed | | Carrier Center Frequency | Carrier Deviation Limits ⁽¹⁾ | | Modulation Frequency | Response Band Limits | | |
| | | | Plus Deviation | Minus Deviation | | | | |
| mm/s | in/s | kHz | kHz | kHz | kHz | dB ⁽²⁾ | | |
| Group I | | | | | | | | |
| 47.6 | 1-7/8 | 6.750 | 9.450 | 4.050 | dc to 1.250 | ±1 | | |
| 95.2 | 3-3/4 | 13.500 | 18.900 | 8.100 | dc to 2.500 | ±1 | | |
| 190.5 | 7-1/2 | 27.000 | 37.800 | 16.200 | dc to 5.000 | ±1 | | |
| 381.0 | 15 | 54.000 | 75.600 | 32.400 | dc to 10.000 | ±1 | | |
| 762.0 | 30 | 108.000 | 151.200 | 64.800 | dc to 20.000 | ±1 | | |
| 1524.0 | 60 | 216.000 | 302.400 | 129.600 | dc to 40.000 | ±1 | | |
| 3048.0 | 120 | 432.000 | 604.800 | 259.200 | dc to 80.000 | ±1 | | |
| Group II | | | | | | | | |
| mm/s | in/s | 47.6 | 1-7/8 | 14.062 | 18.281 | 9.844 | dc to 7.810 | ±1, -3 |
| | | 95.2 | 3-3/4 | 28.125 | 36.562 | 19.688 | dc to 15.620 | ±1, -3 |
| 95.2 | 3-3/4 | 190.5 | 7-1/2 | 56.250 | 73.125 | 39.375 | dc to 31.250 | ±1, -3 |
| 190.5 | 7-1/2 | 381.0 | 15 | 112.500 | 146.250 | 78.750 | dc to 62.50 | ±1, -3 |
| 381.0 | 15 | 62.0 | 30 | 225.000 | 292.50 | 157.50 | dc to 125.0 | ±1, -3 |
| 762.0 | 30 | 1524.0 | 60 | 450.000 | 585.0 | 315.0 | dc to 250.0 | ±1, -3 |
| 1524.0 | 60 | 3048.0 | 120 | 900.000 | 1170.0 | 630.0 | dc to 500.0 | ±1, -3 |
| 3048.0 | 120 | 6096.0 | 240 | 1800.000 | 2340.0 | 1260.0 | dc to 1000.0 | ±1, -3 |
| Notes: | | | | | | | | |
| 1. Input voltage levels per step e below. | | | | | | | | |
| 2. Frequency response referred to 1-kHz output for FM channels 13.5 kHz and above, and 100 Hz for channels below 13.5 kHz. | | | | | | | | |

- d. Speed Control and Compensation. Subsection [17.4](#) shall apply. Note that a separate track is always required for speed control and flutter compensation signals with a single-carrier FM system.
- e. FM Record Parameters. For FM record systems, an input voltage of 1 to 10V peak-to-peak shall be adjustable to produce full frequency deviation.
- f. Deviation Direction. Increasing positive voltage gives increasing frequency. Predetection recorded tapes may be recorded with reverse deviation direction because of the frequency translation techniques employed.
- g. FM Reproduce Systems. Output levels are for signals recorded at full deviation. In wide-band and double-density FM systems, the output is 2 V peak-to-peak minimum across a

load impedance of 75 ohms \pm 10 percent. Increasing input frequency gives a positive going output voltage.

20. PCM Recording

The PCM signals may be successfully recorded using several different methods. Methods included in these standards are predetection recording, post-detection recording, and serial HDDR. Parallel HDDR methods are not included.

20.1. Predetection PCM Recording

This method employs direct recording of the signal obtained by heterodyning the receiver IF signal to one of the center frequencies listed in [Table A.2-10](#) without demodulating the serial PCM signal (see [Figure A.2-12](#)). The maximum recommended bit rate for predetection recording of NRZ data is equal to the predetection carrier frequency, for example, 900 kb/s for a 900 kHz predetection carrier. The maximum recommended bit rate for predetection recording of Bi ϕ data is equal to one-half the predetection carrier frequency. For bit rates greater than one-half the maximum recommended rates, the preferred method of detection is to convert the signal to a higher frequency before demodulation.

20.2. Post-Detection PCM Recording

The serial PCM signal (plus noise) at the video output of the receiver demodulator is recorded by direct or wide band FM recording methods without first converting the PCM signal to bi-level form (see [Figure A.2-12](#)). [Table A.2-12](#) lists maximum bit rates versus tape speed for these recording methods. The minimum recommended reproduce bit rates are 10 kb/s for post-detection direct Bi ϕ and 10 bits per second for post-detection FM (see [Chapter 4](#), Subparagraph 4.2.2.c).

| Table A.2-12. Maximum Recommended Bit Rates, Post-Detection Recording⁽¹⁾ | | | | | | |
|--|---------------|-----------------------|---------------|---|-----------------------------------|-------------------|
| Tape Speed | | | | Post-D Direct Biϕ (kb/s) | Post-FM | |
| Wide Band | | Double Density | | | Biϕ (kb/s) | NRZ (kb/s) |
| (mm/s) | (in/s) | (mm/s) | (in/s) | | | |
| 6096.0 | (240) | 3048.0 | (120) | 1800 | 900 | 1800 |
| 3048.0 | (120) | 1524.0 | (60) | 900 | 450 | 900 |
| 1524.0 | (60) | 762.0 | (30) | 450.0 | 225 | 450 |
| 762.0 | (30) | 381.0 | (15) | 225.0 | 112 | 225 |
| 381.0 | (15) | 109.5 | (7-1/2) | 112.5 | 56 | 112 |
| 190.5 | (7-1/2) | 95.2 | (3-3/4) | 56 | 28 | 56 |
| 95.2 | (3-3/4) | | --- | 28 | 14 | 28 |
| 47.6 | (1-7/8) | | --- | 14 | 7 | 14 |

Note:
 1. Direct recording of NRZ signals is NOT recommended unless the signal format is carefully designed to eliminate low-frequency components for any data expected.

20.3. Serial High-Density Digital Recording

Serial HDDR is a method of recording PCM data on a magnetic tape that involves applying the data to one track of the recorder as a bi-level signal.

20.4. Direct Recording of PCM Telemetry Data

The following subparagraphs deal with standards for direct recording of PCM telemetry data using a wide band analog instrumentation recorder or reproducer system. Direct recording is described in Section 17. The recommended PCM codes, maximum bit rates, record and reproduce parameters, and the magnetic tape requirements are also described.

20.4.1. PCM Codes

The recommended codes for serial high-density PCM recording are Bi ϕ -L and RNRZ-L. The maximum recommended bit packing densities (for wide band recording) are 590 bits per millimeter (b/mm) (15 kb/inch) for Bi ϕ -L and 980 b/mm (25 kb/inch) for RNRZ-L. Refer to [Table A.2-13](#) for maximum recommended bit rates versus standard tape speeds. The minimum recommended reproduce bit rates are 5 kb/s for Bi ϕ -L and 200 kb/s for RNRZ-L. Details of the implementation are discussed in Section 3.

| Table A.2-13. Maximum Recommended Bit Rates | | | | | |
|--|---------|-----------------------|---------|-------------------------------------|----------------------|
| Tape Speed | | | | Biϕ-L (kb/s) | RNRZ-L (kb/s) |
| Wide Band | | Double Density | | | |
| (mm/s) | (in/s) | (mm/s) | (in/s) | | |
| 6096.0 | (240) | 3048.0 | (120) | 3600 | 6000 |
| 3048.0 | (120) | 1524.0 | (60) | 1800 | 3000 |
| 1524.0 | (60) | 762.0 | (30) | 900 | 1500 |
| 762.0 | (30) | 381.0 | (15) | 450 | 750 |
| 381.0 | (15) | 109.5 | (7-1/2) | 225 | 375 |
| 190.5 | (7-1/2) | 95.2 | (3-3/4) | 112 | 187 ⁽¹⁾ |
| 95.2 | (3-3/4) | --- | | 56 | 93 ⁽¹⁾ |
| 47.6 | (1-7/8) | --- | | 28 | 46 ⁽¹⁾ |

Note:
 1. Reproducing data at bit rates less than 200 kb/s is not recommended when using RNRZ-L.

20.4.2. Bi ϕ -L Code.

The Bi ϕ -L code is recommended for direct recording under the following conditions: The bit rate of the data to be recorded does not exceed the maximum bit rates for Bi ϕ -L (see [Table A.2-13](#)), and the amount of tape required for mission recording by this method is not a severe operational constraint.

20.4.3. RNRZ-L Code.

The RNRZ-L code is recommended for direct recording under any of the following conditions: the bit rate of the data to be recorded exceeds the maximum recommended bit rates for Bi ϕ -L (see [Table A.2-13](#)) or maximum tape recording time is needed.

- a. To minimize baseline wander anomalies, RNRZ-L is NOT recommended if the reproduced bit rate is less than 200 kb/s.

- b. The RNRZ-L shall be implemented using a 15-stage shift register and modulo-2 adders (see [Figure A.2-13](#)). The randomized bit stream to be recorded is generated by adding (modulo-2) the input bit stream to the modulo-2 sum of the outputs of the 14th and 15th stages of the shift register. In the decoder, the randomized bit stream is the input to the shift register.

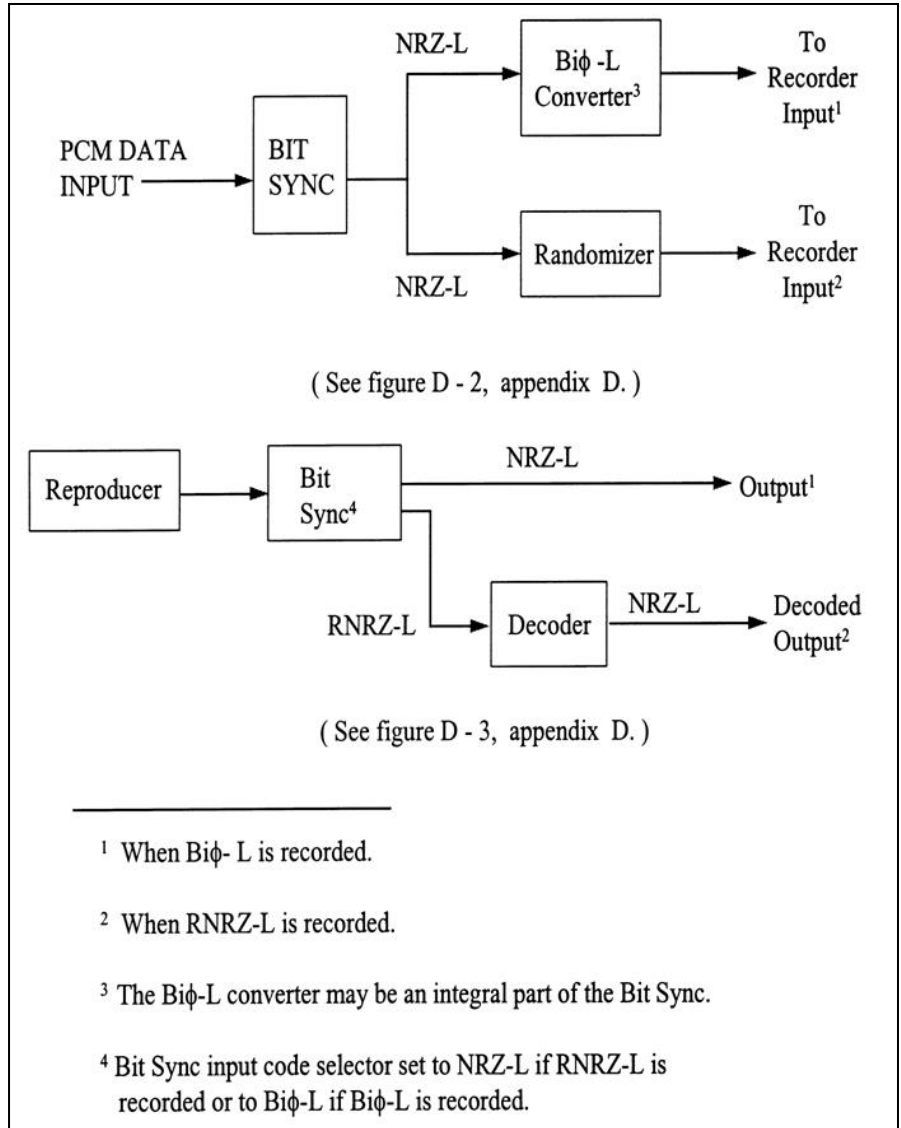

Figure A.2-13. Serial high-density digital record and reproduce

20.4.4. Record Parameters

The record parameters are explained in the following items.

- a. High-density PCM data shall be recorded in compliance with the direct record parameters detailed in Subsection [17.1](#) including the use of an ac bias signal level that produces the required 2 dB over-bias condition.

- b. The peak-to-peak level of the PCM input signal shall be equal to twice the rms value of the signal amplitude used to establish the standard record level with a tolerance of ± 25 percent (see Subparagraph [17.2](#)).
- c. The signal to be recorded must be bi-level. Bi-level signals are signals where only two levels are present. Therefore, signals containing noise must be converted to bi-level signals before they are recorded.
- d. To minimize the effects of tape dropouts, serial high-density digital data should not be recorded on the edge tracks of the tape.

20.4.5. Reproduce Parameters

All reproduce parameters in Subsection [17.3](#) shall apply.

20.4.5.1. PCM Signature

A PCM signature should be recorded before or after or both before and after the data to provide a method for adjusting the reproduce head azimuth and the reproducer equalizers. The data rate of the PCM signature should be the same as the rate of the data to be recorded (see Section [7](#) for tape signature recording).

20.4.5.2. Phase Equalizer

Correct phase equalization is very important to the reconstruction of the serial high-density digital data. Adjustable phase equalizers are desirable but not mandatory.

20.4.6. Magnetic Tape

High-density digital (HDD) magnetic tapes are recommended; however, wide band instrumentation tapes can be used on recorder and reproducer systems with 1.27 mm (0.050 inch) track widths (see Sections [22](#) through [27](#) below).

20.4.7. Tape Copying

The following practices are recommended when making copies of original data tapes.

- a. Convert data reproduced from the original tape to a bi-level signal prior to recording a copy.
- b. Align reproduce head azimuth to original tape.
- c. Adjust reproducer equalizers correctly.
- d. Prior to recording the copy, use the recorded PCM signature to optimize the quality of the reproduced data.

20.4.8. PCM Bit Synchronizer

The PCM bit synchronizer should contain circuitry to reestablish the baseline reference PCM signal (a dc restorer circuit). This circuit is essential when reproducing RNRZ-L at reproduced bit rates less than 1 Mb/s. The PCM bit synchronizer loop bandwidth should be selected for optimum performance between 0.1 and 3 percent of the bit rate.

| | |
|--|--|
|  <p>NOTE</p> | <p>If an appropriate PCM bit synchronizer is not available, the tape can be copied directly; however, the SNR will be decreased.</p> |
|--|--|

21. Preamble Recording for Automatic or Manual Recorder Alignment

A preamble (or postamble) may be recorded on the same tape as the data signal with known frequency and amplitude elements which will allow automatic or manual alignment of the signal electronics to optimize the performance of the playback system. Reproduce azimuth, equalization, and FM demodulator sensitivity may be adjusted at all available tape speeds. The preamble may be used for manual adjustment of any instrumentation magnetic tape recorder/reproducer (wide band and double density). Automatic adjustment requires a recorder/reproducer specifically designed with the capability to automatically adjust one or more of the following: reproduce-head azimuth, amplitude equalization, phase equalization, and FM demodulator sensitivity. The signal source may be internal to the recorder or may be externally generated.

21.1. Alignment, Direct Electronics

Direct electronics shall use a 1/11 band edge square wave for both manual and automatic alignment as given in this annex.

21.2. Alignment, FM Electronics

The FM electronics shall use a 1/11 band edge square wave and ± 1.414 Vdc or 0.05 Hz square wave for both manual and automatic alignment as given in this annex.

22. Magnetic Tape Standards: General

The following standards define terminology, establish key performance criteria, and reference test procedures for longitudinally-oriented oxide, unrecorded magnetic tape designed for instrumentation recording,⁴ and reference specifications for 19 mm (0.75 in) cassettes designed for digital helical scan recording and S-VHS cassettes designed for 12.65 mm (1/2 in) digital helical scan recording. Classes of instrumentation recording tapes include high-resolution (HR) tapes used for wide band recording, HDD tapes used for high-density digital PCM recording, and high energy (HE) tapes used for double-density recording.

Coercivities of HR and HDD tapes are in the range of 275 to 350 oersteds. High-energy tapes have coercivities of 600 to 800 oersteds. Nominal base thickness is 25.4 μm (1.0 mil) and nominal coating thickness is 5 μm (200 microinches) for all tapes. Where required, limits are specified to standardize configurations and to establish the basic handling characteristics of the tape. Limits placed on the remaining requirements must be determined by the tape user in light of the intended application and interchangeability requirements imposed on the tape (see [Table A.2-14](#) for examples of suggested requirement limits).

| Table A.2-14. Suggested Tape Requirement Limits | | |
|--|--|-----------------------|
| Paragraph No. | Tape Requirement | Suggested Limits |
| 27.1 | Bias Level | ± 2.0 dB from MCT |
| 27.2 | Record Level | ± 2.0 dB from MCT |
| 27.3 | Wavelength Response (Table A.2-15) | |

⁴ Federal specifications may be used to replace paragraphs contained in this chapter where applicable. High output and HDD tapes are not included in the federal specifications. Other standards are listed in [Annex A.21](#).

| | | | | |
|----------------------|--|------------------------------------|----------|-------------|
| 27.4 | Output at 0.1 UBE Wavelength | 1.5 dB from MCT | | |
| 27.5 | Short Wavelength Output Uniformity | 2.5 dB (HR tape); 2.5 dB (HE tape) | | |
| 27.6 | Dropouts per 30 m (100 ft) (average) | Center Tracks | | Edge Tracks |
| | | 5 | HR Tape | 10 |
| | | 1 | HDD Tape | 1 |
| | | 20 | HE Tape | 30 |
| 27.7 | Durability (See Table A.2-16) | | | |
| 27.8 | Modulation Noise | 1 dB maximum | | |

| Table A.2-15. Suggested Wavelength Response Requirements | | | |
|---|-----------|-----------------------------|-------------------|
| HR and HDD Tape | | | |
| Measurement Wavelength | | HR Response (dB) | HDD Response (dB) |
| (μm) | (mils) | | |
| 3810.00 | (150.000) | 1.00 | 2.00 |
| 254.00 | (10.000) | 1.00 | 1.00 |
| 15.14 | (0.600) | 0.00 | 0.00 |
| 6.35 | (0.250) | 1.50 | 1.50 |
| 3.18 | (0.125) | 2.00 | 2.00 |
| 2.54 | (0.100) | 2.50 | 2.50 |
| 2.03 | (0.080) | 2.50 | 2.50 |
| 1.52 | (0.060) | 3.00 | 3.00 |
| High-Energy Tape | | | |
| Measurement Wavelength | | HE Wavelength Response (dB) | |
| (μm) | (mils) | | |
| 25.40 | (1.000) | 2.00 | |
| 12.70 | (0.500) | 2.00 | |
| 7.62 | (0.300) | 0.00 | |
| 3.18 | (0.125) | 2.50 | |
| 1.52 | (0.060) | 2.50 | |
| 1.02 | (0.040) | 3.00 | |
| 0.76 | (0.030) | 3.50 | |

| Table A.2-16. Durability Signal Losses | | |
|---|----------|--|
| Designated Tape Length | | Number of Allowable Signal Losses (per pass) |
| Meters | Feet | |
| 762 | (2500) | 2 |
| 1097 | (3600) | 2 |
| 1402 | (4600) | 2 |
| 1524 | (5000) | 2 |
| 2195 | (7200) | 3 |
| 2804 | (9200) | 3 |
| 3292 | (10,800) | 4 |

23. Definitions

Underlined terms appearing within definitions indicate that these terms are defined elsewhere in Section 23.0. For the purpose of this standard, the following definitions apply.

Back Coating. A thin coating of conductive material (for example, carbon) bonded to the surface of a magnetic tape opposite the magnetic-coated surface for reducing electrostatic charge accumulation and for enhancing high-speed winding uniformity. Resistivity of the back coating should be 1 megohm per square or less, whereas the oxide-coated magnetic surface resistivity is much higher (also see magnetic oxide coating).

Base. The material on which the magnetic oxide coating (and back coating, if employed) is applied in the manufacture of magnetic tapes. For most applications, polyester-base materials are currently employed.

Bias Level. The level of high frequency ac bias current or voltage in a direct record system needed to produce a specified level of a UBE frequency sine-wave signal at a particular tape speed. Bias level is usually adjusted to produce maximum output or increased beyond maximum to depress the output 2 dB.

Bi-Directional. Ability of a magnetic tape to record and to reproduce a specified range of signals within specified tolerances of various characteristics when either end of the tape on the reel is used as the leading end.

Binder. Material in which the magnetic oxide particles or back-coating particles are mixed to bond them to the base material.

Blocking. Failure of the magnetic coating to adhere to the base material because of layer-to-layer adhesion in a wound tape pack.

Center Tracks. On a recorded tape, center tracks are those that are more than one-track distance from either edge of the tape, for example, tracks 2 through 13 of a 14-track tape or tracks 2 through 27 of a 28-track tape.

Dropout. A reproduced signal of abnormally low amplitude caused by tape imperfections severe enough to produce a data error. In digital systems, dropouts produce bit errors.

Edge Tracks. The data tracks nearest the two edges of a recorded magnetic tape, for example, tracks 1 and 14 of a 14-track tape.

Erase. Removal of signals recorded on a magnetic tape to allow reuse of the tape or to prevent access to sensitive or classified data. Instrumentation recorders and reproducers do not usually have erase heads, so bulk erasers or degaussers must be employed.

E-Value. The radial distance by which the reel flanges extend beyond the outermost layer of tape wound on a reel under a tape tension of 3.33 to 5.56 newtons (12 to 20 ounces of force) per inch of tape width. Inadequate E-value may prohibit the use of protective reel bands.

High-Density Digital Magnetic Tape. Instrumentation magnetic tape with nominal base thickness of 25.40 μm (1 mil) and coercivity of 275 to 350 oersteds used to record and reproduce high-density digital (PCM) signals with per-track bit densities of 590 b/mm (15 kb/inch) or greater.

High-Energy Magnetic Tape. Magnetic tapes having coercivity of 600 to 800 oersteds and nominal base thickness of 25.4 μm (1 mil) used for double-density analog recording and high-density digital recording above 980 b/mm (25 kb/inch).

High-Resolution Magnetic Tape. Instrumentation magnetic tape used for recording on wide band recorder and reproducer systems. The HR and HDD tapes may have identical coatings

and coercivities (275 to 350 oersteds) but differ in the extent and type of testing conducted by the manufacturer.

Layer-to-Layer Signal Transfer (Print Through). Transfer of a signal to a layer of a wound magnetic tape originating from a signal recorded on an adjacent layer of tape on the same reel. Saturation-level recorded signals and tape storage at elevated temperatures are likely contributors to this effect.

Magnetic Oxide Coating. Material applied to a base material to form a magnetic tape. The magnetic oxide coating contains the oxide particles, the binder, and other plasticizing and lubricating materials necessary for satisfactory operation of the magnetic tape system (also see back coating).

Manufacturer's Centerline Tape (MCT). A tape selected by the manufacturer from his production, where the electrical and physical characteristics are employed as reference standards for all production tapes to be delivered during a particular contractual period. Electrical characteristics include, but are not limited to, bias level, record level, output at 0.1 UBE, and wavelength response. The MCTs are not usually available for procuring agency use.

Manufacturer's Secondary Centerline Tape (MSCT). A tape selected by a manufacturer from his production and provided in lieu of an MCT. On the MSCT, the electrical characteristics may depart from the MCT characteristics, but calibration data referenced in the MCT are provided. All other characteristics of the MSCT are representative of the manufacturer's product.

Modulation Noise. Noise riding on a reproduced signal that is proportional to the amplitude of the recorded signal (below saturation) and results from tape-coating irregularities in particle size, orientation, coercivity, and dispersion.

Record Level. The level of record current or voltage required to achieve a specified reproduce output level with bias level previously set to the correct value. In direct record systems, standard record level is the level of a 0.1 UBE frequency signal required to produce 1 percent third harmonic distortion in the reproduced output signal because of tape saturation.

Scatterwind. Lateral displacements of tape wound on a reel which gives an irregular appearance to the side surfaces of a tape pack. Scatterwind can result from such things as poorly controlled tape tension, guiding, static electrical charge, and poor tape slitting.

Shedding. Loss of magnetic coating from tape during operation on a tape transport. Excessive shedding causes excessive dropout.

Short Wavelength Output Uniformity. A measure of high-frequency reproduce signal amplitude uniformity caused by oxide coating variations.

Upper Band Edge. The highest frequency that can be recorded and reproduced at a particular tape speed in the direct record mode. The UBE signals are used in setting bias level; 0.1 UBE signals are used to set record level.

Wavelength Response. The record and reproduce characteristic of a magnetic tape which depends on tape formulation, coating thickness, and other tape physical parameters and is a function of the wavelength recorded on the tape (tape speed divided by signal frequency) rather than the actual frequency recorded.

Working Length. Length of tape usable for reliable recording and reproduction of data. Actual tape length on a reel exceeds the working length to provide for tape start and stop at each end of the reel without loss of data.

Working Reference Tape (WRT). A tape or tapes of the same type as an MCT or MSCT selected by the user and calibrated to the MCT or MSCT. The WRTs are employed in conducting tests on tape types during a procurement activity and for aligning and testing recorder and reproducer systems to minimize running the MCT or MSCT.

24. General Requirements for Standard Instrumentation Tapes and Reels

The following subparagraphs describe the requirements for tapes and reels.

24.1. Reference Tape System

To establish a set of test procedures that can be performed independently and repeatedly on different manufacturers' tape transports, a centerline reference tape system employing MCT, MSCT, or WRTs as required, should be used. The reference tape system provides a centerline tape against which tape or tape recorder specifications may be tested or standard tapes for aligning operational recorders.

24.1.1. Manufacturer's Centerline Tape

The electrical characteristics provided for a manufacturer's centerline tape include, but are not limited to, bias level, record level, wavelength response, and output at 0.1 UBE wavelength. The physical characteristics of the MCT shall also represent the manufacturer's production and shall be representative of all production tape delivered during any resultant contractual period (see MCT definition in Section [23](#))

24.1.2. Manufacturer's Secondary Centerline Tape

On the MSCT, the electrical characteristics are calibrated to the manufacturer's reference tape, and calibration data are supplied with the MSCT. The physical characteristics of the MSCT shall represent the manufacturer's production (see secondary MSCT definition in Section [23](#)).

24.1.3. Working Reference Tape

Working reference tapes shall be of the same type as those under procurement or test and shall be used in place of a MCT or MSCT for all applicable test procedures (see WRT definition in Section [23](#)).

| | |
|---|---|
|  NOTE | The MCT or MSCT shall be a full-length tape of 25.4 mm (1 in.) width, wound on a 266.7 mm (10 1/2 in.) or 355.6 mm (14 in.) reel or as designated by the tape user. The center one-third of the working tape length shall be used as the calibrated working area. |
|---|---|

24.1.4. Test Recorder and Reproducer

A laboratory quality test recorder shall be designated for use with the reference tape system during any magnetic tape procurement and test program. The recorder selected shall meet the requirements specified in this annex.

24.1.5. MCT/MSCT/WRT Use

Using MCT or MSCT as a reference, the tape user performs all tests necessary to determine if the manufacturer's centerline performance values meet operational and recorder requirements. All acceptable centerline tapes are retained by the tape user as references in subsequent acceptance test procedures performed in support of resultant contracts or contractual periods. A working reference tape, which has been calibrated to an MCT or MSCT, is used as the

actual working reference in the applicable testing procedures outlined in Volume III, RCC Document 118. Dropout tests should use a tape other than the MSCT or WRT.

24.2. Marking and Identifying

See Federal Specification W-T-1553B.⁵

24.3. Packaging

Specified by user.

24.4. Winding

The tape shall be wound on the reel or hub with the oxide surface facing toward the hub (“A” wind). The front of the wound reel is defined as that flange visible when viewing the tape reel with the loose end of the tape hanging from the viewer's right.

24.5. Reels and Hubs

Reels and hubs shall conform to the tape user specified requirements of Federal Specification W-R-175.⁶

24.6. Radial Clearance (E-Value)

For all tape lengths, use 3.175 mm (0.125 inch), (See E-Value definition in Section [23](#)).

24.7. Flammable Materials

Flammable materials shall not be a part of the magnetic tape. Flammable materials will ignite from a match flame and will continue to burn in a still carbon dioxide atmosphere.

24.8. Toxic Compounds

Compounds that produce toxic effects in the environmental conditions normally encountered under operating and storing conditions as defined in Subsection [25.2](#) shall not be part of the magnetic tape. Toxicity is defined as the property of the material that has the ability to do chemical damage to the human body. Highly toxic or corrosive compounds produced under conditions of extreme heat shall be identified and described by the manufacturer.

25. General Characteristics of Instrumentation Tapes and Reels

The following subparagraphs describe the general characteristics for tapes and reels.

⁵ General Services Administration. “General Specification for Tape, Instrumentation, Recording, Magnetic Oxide-Coated.” Federal Specification W-T-1553B. 12 August 1996. Canceled with no replacement. Retrieved 30 June 2020. Available at https://quicksearch.dla.mil/qsDocDetails.aspx?ident_number=49387.

⁶ General Services Administration. “General Specification for Reels and Hubs for Magnetic Recording Tape.” W-R-175D. 22 December 1986. Canceled with no replacement. Retrieved 30 June 2020. Available at https://quicksearch.dla.mil/qsDocDetails.aspx?ident_number=49028.

25.1. Dimensional Specifications

Magnetic tape shall be supplied on flanged reels in the standard lengths, widths, and base thicknesses outlined in [Table A.2-17](#). Reel and hub diameters are taken from Federal Specification W-R-175.

| Table A.2-17. Tape Dimensions | | | |
|--|------------------------------------|------------------------------------|------------------------|
| Dimension | Millimeters | Inches | |
| Tape Width | 25.4 +0 -0.10 | 1.000 +0 -0.004 | |
| Tape Thickness | | | |
| Base Material | 0.025 | 0.0010 | Nominal ⁽¹⁾ |
| Oxide Thickness | 0.005 | 0.0002 | Nominal |
| Tape Length by Reel Diameters (reels with 76 mm (3 in.) center hole) | | | |
| Reel Diameter | Nominal Tape Length ⁽²⁾ | Minimum True Length ⁽³⁾ | |
| 266 mm (10.5 in.) | 1100 m (3600 ft) | 1105 m (3625 ft) | |
| " " " " | 1400 m (4600 ft) | 1410 m (4625 ft) | |
| 356 mm (14.0 in.) | 2200 m (7200 ft) | 2204 m (7230 ft) | |
| " " " " | 2800 m (9200 ft) | 2815 m (9235 ft) | |
| 381 mm (15.0 in.) | 3290 m (10,800 ft) | 3303 m (10,835 ft) | |
| 408 mm (16.0 in.) | 3800 m (12,500 ft) | 3822 m (12,540 ft) | |
| Notes: | | | |
| 1. Actual tape base material thickness slightly less because of manufacturing conventions. | | | |
| 2. Original dimensions are in feet. Metric conversions are rounded for convenience. | | | |
| 3. Tape-to-flange radial clearance (E-value) is 3.18 mm (0.125 in.). | | | |

25.2. Environmental Conditions

The tape shall be able to withstand, with no physical damage or performance degradation, any natural combination of operating or non-operating conditions as defined in subparagraphs [25.2.1](#) and [25.2.2](#) immediately below.

25.2.1. Tape Storing Conditions

Magnetic tape is subject to deterioration at temperature and humidity extremes. In some cases, the damage is reversible, but irreversible damage may occur, especially with long-term storage in unfavorable conditions.

25.2.2. Operating Environment

[Table A.2-18](#) depicts recommended limits.

| Table A.2-18. Environment Recommended Limits | |
|---|---|
| Condition | Range |
| Temperature | 4 to 30°C (40 to 85°F) |
| Humidity | 20 to 60 percent relative humidity (RH) non-condensing |
| Pressure | Normal ground or aircraft operating altitude pressures. For very high altitudes, tape users should consult with |

| | |
|--|--|
| | manufacturers to determine if tape and recorder compatibility is affected by low atmospheric pressure. |
|--|--|

| | |
|--|---|
| NOTE  | <ol style="list-style-type: none"> 1. Binder/oxide system tends to become sticky and unusable above 50°C (125°F). 2. In low humidity, tape binder and oxide system tends to dry out, and oxide and binder adhesion can be unsatisfactory. Brown stains on heads may appear below 40 percent RH. 3. In high humidity, abrasivity is increased and other performance problems may arise. |
|--|---|

25.2.3. Non-operating Environment

Temperature and Relative Humidity:

Short Term: 0 to 45°C (32 to 115°F) and 10 to 70 percent RH non-condensing

Long Term: 1 to 30°C (33 to 85°F) and 30 to 60 percent RH non-condensing

| | |
|--|---|
| NOTE  | Experience has shown that with long exposure to temperatures below freezing, lubricants and plasticizers tend to migrate out of the oxide coating thereby resulting in poor lubrication and gummy surface deposits. |
|--|---|

25.3. Other Characteristics

Storage life, bi-directional performance, frictional vibration, and scatterwind characteristics shall conform to Federal Specification W-T-1553 unless otherwise specified by the tape user at the time of purchase.

26. Physical Characteristics of Instrumentation Tapes and Reels

As specified in Federal Specifications W-T-1553B, W-T-1553/1-4,⁷ and W-R-175.

27. Instrumentation Tape Magnetic and Electrical Characteristics

The following subparagraphs describe required magnetic and electrical tape characteristics.

⁷ General Services Administration. "Tape, Instrumentation Recording, Magnetic Oxide-Coated, 345 Oersteds Coercivity, 5 Dropouts per 100 Foot..." Federal Specification W-T-1553/1. 12 August 1996. Canceled with no replacement. -General Services Administration. "Tape, Instrumentation Recording, Magnetic Oxide-Coated, 345 Oersteds Coercivity, 4 Dropouts per 100 Foot..." Federal Specification W-T-1553/2. 12 August 1996. Canceled with no replacement. -General Services Administration. "Tape, Instrumentation Recording, Magnetic Oxide-Coated, 700 Oersteds Coercivity, 4 Dropouts Per 100 Foot..." Federal Specification W-T-1553/3. 12 August 1996. Canceled with no replacement. -General Services Administration. "Tape, Instrumentation Recording, Magnetic Oxide-Coated, 800 Oersteds Coercivity, 2 Dropouts Per 100 Foot..." Federal Specification W-T-1553/4. 12 August 1996. Canceled with no replacement. Retrieved 16 April 2019. All W-T-1553 documents available at <http://quicksearch.dla.mil/qsSearch.aspx>.

27.1. Bias Level

The bias level (see bias level definition in Section 23) required by the magnetic tape shall not differ from the bias level requirements of the reference tape by more than the amount specified by the tape user. The test procedure outlined in Subparagraph 5.3.8.1, Bias Level, Volume III of RCC Document 118 shall be used to determine compliance with this requirement.

27.2. Record Level

The record level (see record level definition in Section 23) required by the magnetic tape shall not differ from the record level requirements of the reference tape by more than the amount specified by the tape user. The test procedure outlined in Subparagraph 5.3.8.2, Record Level, Volume III of RCC Document 118 shall be used to determine compliance with this requirement.

27.3. Wavelength Response

The output of the magnetic tape, measured at the wavelength values listed in Table A.2-19, shall not differ from the output of the reference tape by more than the amounts specified by the tape user. Wavelength response requirements shall be specified in terms of output after having normalized the output to zero decibels at the 0.1 UBE wavelength. The test procedure outlined in Subparagraph 5.3.9, Wavelength Response and Output at 0.1 Upper Band Edge Wavelength, Volume III of RCC Document 118 shall be used to determine compliance with this requirement (see Table A.2-15).

| Table A.2-19. Measurement Wavelengths | | | |
|--|-----------|-------------------------|----------|
| High-Resolution and HDD Tape | | High-Energy Tape | |
| (μm) | (mils) | (μm) | (mils) |
| 3810.00 | (150.000) | 254.00 | (10.000) |
| 254.00 | (10.000) | 25.40 | (1.000) |
| 25.40 | (1.000) | 12.70 | (0.500) |
| 6.35 | (0.250) | 6.35 | (0.250) |
| 3.18 | (0.125) | 3.18 | (0.125) |
| 2.54 | (0.100) | 2.54 | (0.100) |
| 2.03 | (0.080) | 1.52 | (0.060) |
| 1.52 | (0.060) | 1.02 | (0.040) |
| | | 0.76 | (0.030) |

27.4. Output at 0.1 UBE Wavelength

The wavelength output of the magnetic tape shall not differ from the 0.1 UBE wavelength of the reference tape by more than the amount specified by the tape user. The test procedure outlined in Subparagraph 5.3.9, Wavelength Response and Output at 0.1 Upper Band Edge Wavelength, Volume III of RCC Document 118 shall be used to determine compliance with this requirement.

27.5. Short Wavelength Output Uniformity

The short wavelength output of the magnetic tape shall be consistently uniform so that a signal recorded and reproduced throughout the working tape length in either direction of longitudinal tape motion shall remain free from long-term amplitude variation to the extent specified by the tape user. The test procedure outlined in Subparagraph 5.3.10, Short Wavelength Output Uniformity, Volume III of RCC Document 118 shall be used to determine compliance with this requirement.

27.6. Dropouts

The instantaneous non-uniformity (dropout) output of a recorded signal, caused by the magnetic tape, shall not exceed the center-track and edge-track limits specified by the tape user on the basis of dropouts per 30.48 m (100 ft.) of nominal working tape length. The nominal dropout count shall be determined by totaling all the dropouts per track over the working tape length and dividing by the total number of 30.48 m (100 ft.) intervals tested.

A second method of specifying the allowable dropout count is to specify the maximum number per track for each 30.48 m (100 ft.) interval tested. This method may be preferred if critical data is recorded in specific areas of the working tape length, but a specified number of dropouts per hundred feet greater than the average values may be expected.

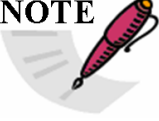
| | |
|---|---|
|  <p>NOTE</p> | <p>Dropout test results are very dependent on the tape transport used for the test and will vary from run to run on a given transport. Edge tracks tend to contain more dropouts than the center tracks, and more dropouts are allowed on the edge tracks. Refer to Table A.2-14.</p> |
|---|---|

For HR tapes, a dropout is defined as a 6 dB reduction in amplitude for a period of 5 microseconds or more of a 1 MHz sine-wave signal recorded and reproduced at a tape speed of 3048 mm/s (120). Signal losses of 6 dB or more which exceed the 5 microsecond time period shall constitute a dropout count for each 5 microsecond time period occurring in the given signal loss. The definitions for center tracks and edge tracks are in Section 23. The test procedure outlined in Subparagraph 5.3.11, Volume III of RCC Document 118 shall be used to determine compliance with this requirement.

For HDD tapes, a dropout is defined as a 10 dB or greater reduction in amplitude for a period of 1 microsecond or more of a square-wave test signal of maximum density recorded and reproduced at 3048 mm/s or 1524 mm/s (120 in/s or 60 in/s). On at least every other track (7 tracks of the odd head on a 28-track head assembly (alternatively, every other track of the even head) record and reproduce a square-wave test signal of 2 MHz at 3048 mm/s (120 in/s) or 1 MHz at 1524 mm/s (60 in/s). The record level shall be set slightly above saturation by adjusting the record current to produce maximum reproduce output and increasing the record current until the output signal is reduced to 90 percent of maximum. For playback, a reproduce amplifier and a threshold detector shall be used. The signal-to-noise ratio of the test signal at the input to the threshold detector shall be at least 25 dB, and the detector shall detect any signal loss of 10 dB or more below reference level. The reference level shall be established by averaging the test signal output level over a 10 m (30.8 ft.) nominal tape length in the vicinity of a dropout.

For each of the seven tracks tested, the accumulated duration in microseconds of detected dropout events shall be displayed and used to directly display the dropout rate for each track

scaled appropriately for the tape working length. Signal losses of 10 dB or more which exceed the 1 microsecond time period shall constitute a dropout count for each microsecond time period occurring in the given signal loss.

For high-energy tapes, a dropout is defined as for high-resolution tapes except that a 2-MHz signal is used.

27.7. Durability

The magnetic tape shall resist deterioration in magnetic and electrical performance because of wear to the coating surface. Signal losses, as defined below, caused by surface wear shall not occur in excess of the per-pass limits specified in [Table A.2-16](#) for the first 35 passes.

Signal losses in excess of those limits specified above shall not occur during either a record, record and reproduce or uninterrupted reproduce pass of the working tape length. Signal loss is a reduction in signal amplitude of 3 dB or greater for a period of 3 through 10 seconds of a recorded and reproduced short wavelength signal. Where a continuous loss of signal of 3 dB or greater exceeds the 10-second period, a signal loss count shall be required for every sequential 10-second time period occurring in the given signal loss. The test procedure outlined in Subparagraph 5.3.12, Durability, Volume III of RCC Document 118 shall be used to determine compliance with this requirement.

27.8. Modulation Noise

The amplitude modulation superimposed upon a recorded and reproduced signal by the magnetic tape shall not exceed the limits specified by the tape user. The test procedure outlined in Subparagraph 5.3.13, Modulation Noise, Volume III of RCC Document 118 shall be used to determine compliance with this requirement.

27.9. Layer-to-Layer Signal Transfer

A signal resulting from layer-to-layer signal transfer shall be reduced in amplitude from the original signal a minimum of 40 dB for 25.4 μm (1.0 mil) tape and 46 dB for 38.1 μm (1.5 mils) tape. The test procedure outlined in Subparagraph 5.3.14, Layer-to-Layer Signal Transfer, Volume III of RCC Document 118 shall be used to determine compliance with this requirement.

27.10. Erase Ease

For HR and HDDR tapes, an erase field of 79.58 kiloamps per meter (kA/m) (1000 oersteds) shall effect at least a 60 dB reduction in output amplitude of a previously recorded 25.4 μm (1.0 mil) wavelength signal. For HE tapes, an erase field of 160 kA/m (2000 oersteds) shall effect at least a 60 dB reduction of a previously recorded 25.4 μm (1.0 mil) wavelength signal. The test procedure outlined in Subparagraph 5.3.15, Volume III of RCC Document 118 shall be used to determine compliance with this requirement.

27.11. Suggested Tape Requirement Limits

[Table A.2-14](#) lists some suggested limits to be used for instrumentation tape.

ANNEX B Citations

- General Services Administration. "General Specification for Tape, Instrumentation, Recording, Magnetic Oxide-Coated." Federal Specification W-T-1553B. 12 August 1996. Canceled with no replacement. Retrieved 30 June 2020. Available at https://quicksearch.dla.mil/qsDocDetails.aspx?ident_number=49387.
- . "General Specification for Reels and Hubs for Magnetic Recording Tape." W-R-175D. 22 December 1986. Canceled with no replacement. Retrieved 30 June 2020. Available at https://quicksearch.dla.mil/qsDocDetails.aspx?ident_number=49028.
- . "Tape, Instrumentation Recording, Magnetic Oxide-Coated, 345 Oersteds Coercivity, 4 Dropouts per 100 Foot..." Federal Specification W-T-1553/2. 12 August 1996. Canceled with no replacement. Retrieved 30 June 2020. Available at https://quicksearch.dla.mil/qsDocDetails.aspx?ident_number=121475.
- . "Tape, Instrumentation Recording, Magnetic Oxide-Coated, 345 Oersteds Coercivity, 5 Dropouts per 100 Foot..." Federal Specification W-T-1553/1. 12 August 1996. Canceled with no replacement. Retrieved 30 June 2020. Available at https://quicksearch.dla.mil/qsDocDetails.aspx?ident_number=121474.
- . "Tape, Instrumentation Recording, Magnetic Oxide-Coated, 700 Oersteds Coercivity, 4 Dropouts Per 100 Foot..." Federal Specification W-T-1553/3. 12 August 1996. Canceled with no replacement. Retrieved 30 June 2020. Available at https://quicksearch.dla.mil/qsDocDetails.aspx?ident_number=121476.
- . "Tape, Instrumentation Recording, Magnetic Oxide-Coated, 800 Oersteds Coercivity, 2 Dropouts Per 100 Foot..." Federal Specification W-T-1553/4. 12 August 1996. Canceled with no replacement. Retrieved 30 June 2020. Available at https://quicksearch.dla.mil/qsDocDetails.aspx?ident_number=121477.
- Range Commanders Council. *IRIG Serial Time Code Formats*. IRIG Standard 200-16. May be superseded by update. Retrieved 30 June 2020. Available at <https://www.trmc.osd.mil/wiki/x/wou8Bg>.
- . *IRIG Standard Parallel Binary and Parallel Binary Coded Decimal Time Code Formats*. IRIG Standard 205-87. May be superseded by update. Retrieved 30 June 2020. Available to RCC members with Private Page access at <https://www.trmc.osd.mil/wiki/x/9IVyBQ>.
- . *Test Methods for Recorder and Reproducer Systems and Magnetic Tape*. Volume III. RCC 118-99. May be superseded by update. Retrieved 30 June 2020. Available at <https://www.trmc.osd.mil/wiki/x/fou8Bg>.
- . *Test Methods for Telemetry Systems and Subsystems*. Volume IV. RCC 118-79. May be superseded by update. Retrieved 30 June 2020. Available at <https://www.trmc.osd.mil/wiki/x/gIu8Bg>.

****** END OF ANNEX A.2 ******