



**IRIG STANDARD 106-22**

**TELEMETRY STANDARDS**

**ABERDEEN TEST CENTER  
DUGWAY PROVING GROUND  
ELECTRONIC PROVING GROUND  
REAGAN TEST SITE  
REDSTONE TEST CENTER  
WHITE SANDS TEST CENTER  
YUMA PROVING GROUND**

**NAVAL AIR WARFARE CENTER AIRCRAFT DIVISION PATUXENT RIVER  
NAVAL AIR WARFARE CENTER WEAPONS DIVISION CHINA LAKE  
NAVAL AIR WARFARE CENTER WEAPONS DIVISION POINT MUGU  
NAVAL SURFACE WARFARE CENTER DAHLGREN DIVISION  
NAVAL UNDERSEA WARFARE CENTER DIVISION KEYPORT  
NAVAL UNDERSEA WARFARE CENTER DIVISION NEWPORT  
PACIFIC MISSILE RANGE FACILITY**

**96th TEST WING  
412th TEST WING  
ARNOLD ENGINEERING DEVELOPMENT COMPLEX**

**SPACE LAUNCH DELTA 30  
SPACE LAUNCH DELTA 45**

**NATIONAL AERONAUTICS AND SPACE ADMINISTRATION**

**DISTRIBUTION A: APPROVED FOR PUBLIC RELEASE  
DISTRIBUTION IS UNLIMITED**

This page intentionally left blank.

**DOCUMENT 106-22**

**TELEMETRY STANDARDS**

**May 2022**

**Prepared by**

**TELEMETRY GROUP**

**Published by**

**Secretariat  
Range Commanders Council  
US Army White Sands Missile Range,  
New Mexico 88002-5110**

This page intentionally left blank.

## TABLE OF CONTENTS

Changes in This Edition.....	v
Preface.....	vii

### CHAPTERS

<a href="#">CHAPTER 1:</a>	<a href="#">Introduction</a>
<a href="#">CHAPTER 2: *</a>	<a href="#">Transmitter and Receiver Systems</a>
<a href="#">CHAPTER 3:</a>	<a href="#">Frequency Division Multiplexing Telemetry Standards</a>
<a href="#">CHAPTER 4:</a>	<a href="#">Pulse Code Modulation Standards</a>
<a href="#">CHAPTER 5:</a>	<a href="#">Digitized Audio Telemetry Standard</a>
<a href="#">CHAPTER 6:</a>	<a href="#">Recorder &amp; Reproducer Command and Control</a>
<a href="#">CHAPTER 7:</a>	<a href="#">Packet Telemetry Downlink</a>
<a href="#">CHAPTER 8:</a>	<a href="#">Digital Data Bus Acquisition Formatting Standard</a>
<a href="#">CHAPTER 9: *</a>	<a href="#">Telemetry Attributes Transfer Standard</a>
<a href="#">CHAPTER 10:</a>	<a href="#">Digital On-board Recorder Standard</a>
<a href="#">CHAPTER 11: *</a>	<a href="#">Recorder Data Packet Format Standard</a>
<a href="#">CHAPTER 21:</a>	<a href="#">Telemetry Network Standard Introduction</a>
<a href="#">CHAPTER 22:</a>	<a href="#">Network-Based Protocol Suite</a>
<a href="#">CHAPTER 23:</a>	<a href="#">Metadata Configuration</a>
<a href="#">CHAPTER 24:</a>	<a href="#">Message Formats</a>
<a href="#">CHAPTER 25:</a>	<a href="#">Management Resources</a>
<a href="#">CHAPTER 26:</a>	<a href="#">TmNSDataMessage Transfer Protocol</a>
<a href="#">CHAPTER 27:</a>	<a href="#">Radio Frequency Network Access Layer</a>
<a href="#">CHAPTER 28:</a>	<a href="#">Radio Frequency Network Management</a>

\* Changed

### APPENDIXES

Beginning with RCC 106-17, the appendixes that were previously stand-alone documents are now integrated with the chapters that cover the same material. This does not include four appendixes that are retired but maintained for historical purposes; these four remain stand-alone files and are renamed as annexes. The following lists new locations for the appendixes.

Appendix A, Frequency Considerations for Telemetry	<a href="#">Chapter 2</a> , Appendix 2-A
Appendix B, Use Criteria for Frequency Division Multiplexing	<a href="#">Chapter 3</a> , Appendix 3-A
Appendix C, PCM Standards (Additional Information and Recommendations)	<a href="#">Chapter 4</a> , Appendix 4-A
Appendix D, Magnetic Tape Recorder and Reproducer Information and Use Criteria	<a href="#">Annex A-2</a>
Appendix E, Deleted (Available Transducer Documentation)	none
Appendix F, Continuously Variable Slope Delta Modulation	<a href="#">Chapter 5</a> , Appendix 5-A
Appendix G, ADARIO Data Block Field Definitions	<a href="#">Annex A-3</a>
Appendix H, Application of the Telemetry Attributes Transfer Standard	<a href="#">Chapter 9</a> , Appendix 9-A

Appendix I, Telemetry Attributes Transfer Standard Cover Sheet	<a href="#">Chapter 9</a> , Appendix 9-B
Appendix J, Telemetry Attributes Transfer Standard Format Example	<a href="#">Chapter 9</a> , Appendix 9-C
Appendix K, Pulse Amplitude Modulation Standards	<a href="#">Annex A-1</a>
Appendix L, Asynchronous Recorder Multiplexer Output Re- constructor (ARMOR)	<a href="#">Annex A-4</a>
Appendix M, Properties of the Differential Encoder Specified in IRIG Standard 106 for OQPSK Modulations	<a href="#">Chapter 2</a> , Appendix 2-B
Appendix N, Telemetry Transmitter Command and Control Protocol *	<a href="#">Chapter 2</a> , Appendix 2-C
Appendix O, Floating Point Formats	<a href="#">Chapter 9</a> , Appendix 9-D
Appendix P, Derived Parameter Specification	<a href="#">Chapter 9</a> , Appendix 9-E
Appendix Q, Extended Binary Golay Code	<a href="#">Chapter 7</a> , Appendix 7-A
Appendix R, Low-Density Parity Check Code for Telemetry Systems	<a href="#">Chapter 2</a> , Appendix 2-D
Appendix S, Space-Time Coding for Telemetry Systems	<a href="#">Chapter 2</a> , Appendix 2-E

## Changes in This Edition

This document is an updated version of and replaces Range Commanders Council (RCC) Document 106-20. The RCC Telemetry Group (TG) made an extensive effort to produce a well-coordinated and useful document. The following is a summary of these efforts.

- a. Task TG-169: Updates to the Digital Telemetry Recording Standards.  
OBJECTIVE/SCOPE: Update IRIG 106 Chapters 6, 9R, 10, and 11 to include recorder capabilities required by the RCC range members.
- b. Task TG-171: Updates in Chapter 9.  
OBJECTIVE/SCOPE: Update IRIG 106 Chapter 9 with updates discussed in TG 136 and 137. This task created a new sub-messages Q Group in Chapter 9.
- c. Task TG-173: Add CRC to Chapter 7 TmNS Message and Ethernet MAC layer packet types  
OBJECTIVE/SCOPE: Add CRC to Chapter 7 Packet types that don't have an existing CRC. Add attribute in Chapter 9 for presence of CRC.
- d. Task TG-176: Adjacent Channel Interference (ACI) Performance for Coded Waveforms.  
OBJECTIVE/SCOPE: IRIG 106 Appendix 2-A.4 contains minimum frequency spacing recommendations for the three waveforms in the standard, PCM/FM, SOQPSK, and ARTM CPM. This task will update that recommendation as needed for the coded waveforms SOQPSK-STC and SOQPSK-LDPC now in the standard. The recommendation will be based upon extensive lab testing in the Telemetry Lab with all combinations of coded and uncoded waveforms.
- e. Task TG-177: IRIG 106 Chapter 2 Modulation  
OBJECTIVE/SCOPE: The three modulations in Chapter 2 (PCM/FM, SOQPSK, ARTM CPM) are currently defined correctly but are inconsistent in their definitions. This task will redefine each waveform as variants of the general case of Continuous Phase Modulation (CPM). Since FQPSK has not been adopted by the AMT community, it has been moved to Appendix 2-B.
- f. Task TG-180: Augmentation of IRIG 106 Appendix 2-D with LDPC Parity Examples  
OBJECTIVE/SCOPE: Add examples in IRIG 106 Appendix 2-D, specifically D.4 and D.5, for each Low-Density Parity Check (LDPC) encoding scheme that includes information block test patterns and resulting parities.
- g. Task TG-182: Data Quality Encapsulation for Coded Telemetry Links  
OBJECTIVE/SCOPE: Data Quality Metrics (DQM) and thus Data Quality Encapsulation (DQE) are gaining wide acceptance as the source selection metric for Best Source Selection (BSS). This combined with the implementation of coded telemetry links requires an update to Appendix 2-G of IRIG 106. This task will specify payload lengths in the DQE message when utilizing Space-Time Code (STC), forward error correction in the form of LDPC or a combination of both (STC-LDPC) in the telemetry link.

This page intentionally left blank.



## Preface

The TG of the RCC has prepared this document to foster the compatibility of telemetry transmitting, receiving, and signal processing equipment at the member ranges under the cognizance of the RCC. The range commanders highly recommend that telemetry equipment operated by the ranges and telemetry equipment used in programs that require range support conform to these standards.

These standards do not necessarily define the existing capability of any test range, but constitute a guide for the orderly implementation of telemetry systems for both ranges and range users. The scope of capabilities attainable with the utilization of these standards requires the careful consideration of tradeoffs. Guidance concerning these tradeoffs is provided in the text. The standards provide the necessary criteria on which to base equipment design and modification. The ultimate purpose is to ensure efficient spectrum utilization, interference-free operation, interoperability between ranges, and compatibility of range user equipment with the ranges.

This standard is complemented by a companion series: RCC Document 118, Test Methods for Telemetry Systems and Subsystems; RCC Document 119, Telemetry Applications Handbook; RCC Document 123, IRIG 106 Chapter 10 Programmers Handbook; and RCC Document 124, Telemetry Attributes Transfer Standard (TMATS) Handbook.

The policy of the TG is to update the telemetry standards and test methods documents as required to be consistent with advances in technology.

Please direct any questions to:

Secretariat, Range Commanders Council  
ATTN: TEWS-TDR  
1510 Headquarters Avenue  
White Sands Missile Range, New Mexico 88002-5110  
Telephone (575) 678-1107, DSN 258-1107  
E-mail [rcc-feedback@trmc.osd.mil](mailto:rcc-feedback@trmc.osd.mil)

**\*\*\*\*\* NOTHING FOLLOWS \*\*\*\*\***

## CHAPTER 1

### Introduction

The Telemetry Standards address the here-to-date conventional methods, techniques, and practices affiliated with aeronautical telemetry applicable to the member RCC ranges. The first 11 chapters are generally devoted to a different element of the telemetry system or process. Chapters 21 through 28 address the topic of network telemetry. These chapters are to be used together to define the various aspects of network telemetry.

Reference documents are identified at the point of reference. Commonly used terms are defined in standard reference glossaries and dictionaries. Definitions of terms with special applications are included when the term first appears, generally in appendices of individual chapters. Radio frequency terms are defined in the *Manual of Regulations and Procedures for Federal Radio Frequency Management*. Copies of that manual may be obtained from:

Executive Secretary, Interdepartmental Radio Advisory Committee (IRAC)  
U.S. Department of Commerce, National Telecommunications and Information  
Administration (NTIA)  
Room 1087, HCHB Building  
1401 Constitution Avenue, N.W.  
Washington, D.C. 20230

This page intentionally left blank.

## CHAPTER 2

### Transmitter and Receiver Systems

<b>Acronyms</b> .....	<b>ix</b>
<b>Chapter 2. Transmitter and Receiver Systems</b> .....	<b>2-1</b>
2.1 Radio Frequency Standards for Telemetry .....	2-1
2.2 Bands.....	2-1
2.2.1 Allocation of the Lower L-Band (1435 to 1535 MHz).....	2-2
2.2.2 Allocation of the Lower S-Band (2200 to 2300 MHz).....	2-2
2.2.3 Allocation of the Upper S-Band (2310 to 2395 MHz) .....	2-2
2.2.4 Allocation of the Lower C-Band (4400 to 4940 MHz).....	2-3
2.2.5 Allocation of the Middle C-Band (5091 to 5150 MHz) .....	2-3
2.2.6 Allocation of the Upper C-Band (5925 to 6700 MHz).....	2-3
2.3 Telemetry Transmitter Systems .....	2-3
2.3.1 Center Frequency Tolerance .....	2-3
2.3.2 Output Power .....	2-3
2.3.3 Modulation.....	2-3
2.3.4 Spurious Emission and Interference Limits.....	2-15
2.3.5 Operational Flexibility .....	2-16
2.3.6 Modulated Transmitter Bandwidth.....	2-16
2.3.7 Valid Center Frequencies Near Telemetry Band Edges .....	2-17
2.4 Telemetry Receiver Systems.....	2-17
2.4.1 Spurious Emissions.....	2-17
2.4.2 Frequency Tolerance.....	2-17
2.4.3 Receiver Phase Noise.....	2-17
2.4.4 Spurious Responses .....	2-18
2.4.5 Operational Flexibility .....	2-18
2.4.6 Intermediate Frequency Bandwidths .....	2-18
2.4.7 C-band Downconversion .....	2-18
2.5 Codes for Telemetry Systems .....	2-19
2.5.1 Low-Density Parity-Check Code.....	2-19
2.5.2 Space-Time Code.....	2-19
2.6 Randomization Methods for Telemetry Systems.....	2-20
2.6.1 Introduction.....	2-20
2.6.2 Randomizer Types .....	2-20
2.6.3 Randomizer Application .....	2-20
2.7 Data Quality Metrics and Data Quality Encapsulation.....	2-20
2.8 Interference Protection Criteria for Aeronautical Mobile Telemetry Systems.....	2-20
<b>Appendix 2-A. Frequency Considerations for Telemetry</b> .....	<b>A-1</b>

A.1.	Purpose.....	A-1
A.2.	Scope.....	A-1
A.2.a.	Definitions.....	A-1
A.2.b.	Modulation methods .....	A-1
A.2.c.	Other Notations.....	A-2
A.3.	Authorization to Use a Telemetry System .....	A-2
A.3.a.	RF Spectrum Support Certification .....	A-2
A.3.b.	Frequency Authorization .....	A-4
A.4.	Frequency Usage Guidance .....	A-4
A.4.a.	Minimum Frequency Separation.....	A-4
A.4.b.	Geographical Separation.....	A-12
A.4.c.	Multicarrier Operation .....	A-12
A.4.d.	Transmitter Antenna System Emission Testing.....	A-12
A.5.	Bandwidth.....	A-12
A.5.a.	Concept .....	A-13
A.5.b.	Bandwidth Estimation and Measurement .....	A-14
A.5.c.	Other Bandwidth Measurement Methods .....	A-16
A.5.d.	Spectral Equations .....	A-18
A.5.e.	Receiver Bandwidth.....	A-20
A.5.f.	Receiver Noise Bandwidth .....	A-21
A.5.g.	Symmetry .....	A-21
A.5.h.	FM Transmitters (alternating current-coupled) .....	A-21
A.6.	Spectral Occupancy Limits .....	A-21
A.6.a.	Spectral Mask.....	A-21
A.6.b.	Spectral Mask Examples.....	A-23
A.7.	Technical Characteristics of Digital Modulation Methods.....	A-24
A.8.	SOQPSK-TG Characteristics.....	A-25
A.9.	Advanced Range Telemetry Continuous Phase Modulation Characteristics .....	A-26
A.10.	PCM/FM .....	A-27
A.11.	Valid Center Frequencies Near Telemetry Band Edges .....	A-28

**Appendix 2.B. Properties of the Differential Encoder Specified in IRIG Standard 106 for OQPSK Modulations..... B-1**

B.1.	Introduction.....	B-1
B.2.	The Need For Differential Encoding .....	B-1
B.3.	A Simple Solution To The Carrier Phase Ambiguity Problem.....	B-3
B.4.	Immunity to Carrier Phase Rotation .....	B-6
B.5.	Initial Values.....	B-8
B.6.	Error Propagation.....	B-9
B.7.	Recursive Processing and Code Memory .....	B-9
B.8.	Frequency Impulse Sequence Mapping for SOQPSK.....	B-11
B.9.	Summary .....	B-12

B.10. System-Level Software Reference Implementation of Differential Encoder  
 Defined in IRIG Standard 106 for FQPSK and SOQPSK Modulations..... B-12

B.10.a. Introduction.....B-12

B.10.b. Matlab Workspace Operation .....B-13

B.10.c. Script for Modules .....B-14

**Appendix 2-C. Telemetry Transmitter Command and Control Protocol..... C-1**

C.1. Introduction..... C-1

C.2. Command Line Interface ..... C-1

C.2.a. User Command Line Interface.....C-1

C.2.b. Optional Programming Interface .....C-1

C.3. Initialization ..... C-2

C.4. Basic Command Set..... C-2

C.4.a. Basic Command Set Summary .....C-2

C.4.b. Commands: Basic Command Set.....C-3

C.5. Extended Command Set..... C-10

C.5.a. Extended Command Set Summary .....C-10

C.5.b. Commands: Extended Command Set .....C-11

C.6. Transmitter Communication Example..... C-14

C.7. Non-Standard Commands..... C-14

C.8. Physical Layer(s) ..... C-14

**Appendix 2-D. Low-Density Parity-Check Codes for Telemetry Systems..... D-1**

D.1. Background..... D-1

D.2. Code Description ..... D-1

D.3. Parity Check Matrices..... D-2

D.4. Encoding ..... D-9

D.4.a. Code Rate =1/2, Information Block Size = 1024,  $M = 512$  ..... D-11

D.4.b. Code Rate =1/2, Information Block Size = 4096,  $M = 2048$  ..... D-12

D.4.c. Code Rate =2/3, Information Block Size = 1024,  $M = 256$ ..... D-17

D.4.d. Code Rate =2/3, Information Block Size = 4096,  $M = 1024$ ..... D-21

D.4.e. Code Rate =4/5, Information Block Size = 1024,  $M = 128$ ..... D-27

D.4.f. Code Rate =4/5, Information Block Size = 4096,  $M = 512$  ..... D-34

D.4.g. Example Data Tst Patterns and Resulting Parity Values ..... D-41

D.5. Synchronization ..... D-43

D.6. Randomization ..... D-44

D.7. Performance ..... D-45

**Appendix 2-E. Space-Time Coding for Telemetry Systems ..... E-1**

E.1. Code Description .....E-1

E.2. Modulation.....E-3

E.3. Performance .....E-4

E.4.	Resources .....	E-6
E.5.	Combining Coding Schemes.....	E-6
<b>Appendix 2-F. Use of Recommendation ITU-R M.1459 for Protection of AMT Ground Stations from Terrestrial, Airborne, and Satellite Interference .....</b>		
<b>F-1</b>		
F.1.	Introduction and Summary .....	F-1
F.2.	Practical Application of the Rec M.1459 Protection Criteria.....	F-1
<b>Appendix 2-G. Standards for Data Quality Metrics and Data Quality Encapsulation.....</b>		
<b>G-1</b>		
G.1.	Purpose.....	G-1
G.2.	Scope.....	G-1
G.3.	Data Quality Metric .....	G-1
G.4.	Data Quality Encapsulation Protocol.....	G-2
<b>Appendix 2-H. Dynamic Multipath Channel Model for Aeronautical Mobile Telemetry.....</b>		
<b>H-1</b>		
H.1.	Preliminaries .....	H-1
H.2.	The Dynamic Multipath Channel.....	H-2
H.3.	Channel Emulator Settings .....	H-3
<b>Appendix 2-I. Citations.....</b>		
<b>I-1</b>		

### Table of Figures

Figure 2-1.	A Conceptual CPM Modulator .....	2-5
Figure 2-2.	PCM/FM Modulator Using a Pre-modulation Filter .....	2-6
Figure 2-3.	Frequency Pulse Shapes Generated by Filtering an NRZ Pulse Shape .....	2-8
Figure 2-4.	The Frequency Pulse for SOQPSK-TG .....	2-10
Figure 2-5.	Eye Diagrams for the Inphase (Top) and Quadrature (Bottom) Components of SOQPSK-TG .....	2-11
Figure 2-6.	Block Diagram of an SOQPSK-TG Modulator Showing the Placement of the Differential Encoder.....	2-12
Figure 2-7.	The Frequency Pulse for ARTM CPM .....	2-14
Figure 2-8.	Continuous Single-Sideband Phase Noise Power Spectral Density .....	2-15
Figure A-1.	Spectra of 5-Mbps PCM/FM, SOQPSK-TG, and ARTM CPM Signals.....	A-4
Figure A-2.	Center Frequency Spacing 5 Mbps PCM/FM and 3 Mbps SOQPSK-TG.....	A-7
Figure A-3.	Center Frequency Spacing 12.5 Mbps PCM/FM and 6 Mbps ARTM CPM.....	A-7
Figure A-4.	Center Frequency Spacing 4.3 Mbps SOQPSK-TG and 7.25 Mbps SOQPSK-TG.....	A-8
Figure A-5.	Center Frequency Spacing 8 Mbps SOQPSK-LDPC and 4.2 Mbps PCM/FM .....	A-8
Figure A-6.	Center Frequency Spacing 3.6 Mbps SOQPSK-LDPC and 12 Mbps SOQPSK-TG.....	A-9
Figure A-7.	Center Frequency Spacing 8 Mbps SOQPSK-STC and 2 Mbps PCM/FM.....	A-9



Figure A-8. Center Frequency Spacing 5.8 Mbps SOQPSK-STC/LDPC and 6.95 Mbps SOQPSK-LDPC..... A-10

Figure A-9. Center Frequency Spacing 11 Mbps SOQPSK and 2.7 Mbps SOQPSK-LDPC ..... A-11

Figure A-10. Center Frequency Spacing 5 Mbps SOQPSK-STC and 5 Mbps SOQPSK-STC ..... A-11

Figure A-11. RNRZ PCM/FM Signal ..... A-15

Figure A-12. Spectrum Analyzer Calibration of 0-dBc Level ..... A-16

Figure A-13. Biφ PCM/PM Signal ..... A-17

Figure A-14. FM/AM Signal and Carson’s Rule ..... A-18

Figure A-15. Typical Receiver RLC IF Filter Response (−3 dB Bandwidth = 1 MHz) ..... A-20

Figure A-16. RLC and SAW IF Filters ..... A-20

Figure A-17. Filtered 5-Mbps RNRZ PCM/FM Signal and Spectral Mask..... A-23

Figure A-18. Unfiltered 5-Mbps RNRZ PCM/FM Signal and Spectral Mask..... A-23

Figure A-19. Typical 5-Mbps SOQPSK TG Signal and Spectral Mask ..... A-24

Figure A-20. Typical 5-Mbps ARTM CPM Signal and Spectral Mask..... A-24

Figure A-21. Measured SOQPSK-TG Phase Trajectory ..... A-25

Figure A-22. SOQPSK-TG Power Spectrum (5 Mbps) ..... A-26

Figure A-23. BEP vs.  $E_b/N_0$  Performance of 5 Mbps SOQPSK-TG..... A-26

Figure A-24. Power Spectrum of 5 Mbps ARTM CPM..... A-27

Figure A-25. BEP vs.  $E_b/N_0$  Performance of 5 Mbps ARTM CPM..... A-27

Figure A-26. Power Spectrum of 5 Mbps PCM/FM Signal ..... A-28

Figure A-27. BEP vs.  $E_b/N_0$  Performance of 5-Mbps PCM/FM ..... A-28

Figure A-28. Spectral Masks at −25 dBm ..... A-29

Figure A-29. Bit Rate vs. Band Edge Back-off ..... A-30

Figure B-1. Transmission System ..... B-2

Figure B-2. OQPSK 106 Symbol-to-Phase Mapping Convention..... B-2

Figure B-3. Detection Ambiguity..... B-3

Figure B-4. QPSK State Timing..... B-4

Figure B-5. OQPSK State Timing..... B-4

Figure B-6. SOQPSK Transmitter..... B-11

Figure B-7. OQPSK Transmitter (With Precoder)..... B-12

Figure C-1. Terminal Window for STC-Enabled Transmitter ..... C-10

Figure C-2. Typical Terminal Window ..... C-14

Figure D-1. Parity Check Matrix H for (n=2048, k=1024) Rate 1/2..... D-4

Figure D-2. Parity Check Matrix H for (n=8192, k=4096) Rate 1/2..... D-5

Figure D-3. Parity Check Matrix H for (n=1536, k=1024) Rate 2/3..... D-6

Figure D-4. Parity Check Matrix H for (n=6144, k=4096) Rate 2/3..... D-7

Figure D-5. Parity Check Matrix H for (n=1280, k=1024) Rate 4/5..... D-8

Figure D-6. Parity Check Matrix H for (n=5120, k=4096) Rate 4/5..... D-9

Figure D-7. Quasi-Cyclic Encoder Using Feedback Shift Register ..... D-10

Figure D-8. ASM/Codeblock Structure..... D-43

Figure D-9. Codeblock Randomizer..... D-44

Figure D-10. LDPC Detection Performance with 4-state Trellis Demodulator ..... D-45

Figure D-11. LDPC Detection Performance with Symbol-by-Symbol Demodulator..... D-46

Figure E-1. Symbol-to-Phase Mapping for IRIG-106 Offset QPSK Modulation ..... E-1

Figure E-2.	Notional Diagram Illustrating the Periodic Insertion of 128 Pilot Bits Every 3200 Alamouti-Encoded Bits .....	E-3
Figure E-3.	Notional Block Diagram of the Space-Time Code Transmitter .....	E-4
Figure E-4.	Example Detection Curve Performance.....	E-6
Figure F-1.	Excerpt from Article 21 of the International Radio Regulations .....	F-5
Figure F-2.	Geometry of a Geostationary Link Showing (a) Elevation, (b) Azimuth from a Point T on the Earth.....	F-8
Figure F-3.	Digital Audio Radio Service Downlink Beam Gain Contours .....	F-9
Figure F-4.	Elevation Angles from Surface of the Earth to the 115.2° West Longitude Orbital Location .....	F-10
Figure F-5.	FCC Emission Mask for the WCS OOB Band from 2360 – 2390 MHz.....	F-11
Figure F-6.	Simulated OOB Emissions from an LTE Handset .....	F-12
Figure F-7.	Graphical Representation of the Two-Ray Model .....	F-14
Figure F-8.	Comparison of Free-Space One-Slope and Two-Ray Propagation Models .....	F-15
Figure F-9.	Rayleigh Fading of a Signal Transmitted from a Moving Platform .....	F-16
Figure F-10.	S-band Telemetry Signal Received from an Aircraft in Flight.....	F-17
Figure F-11.	Rayleigh Distribution as Presented in Figure 2 of Rec M.1459 (Jablonski 2004) .....	F-18
Figure F-12.	EDX Signal Pro Map of Hypothetical Transmitters and Receivers in the Pax River Region .....	F-21
Figure F-13.	EDX Signal Pro Path Loss Profile for the TX007 to RX007 Path .....	F-21
Figure F-14.	Actual Measured Path Loss Data from an NTIA Report (Hufford and Steele) .....	F-22
Figure F-15.	Composite AMT Pattern from Rec M.1459 .....	F-26
Figure F-16.	Aggregate Interference as a Function of AMT Antenna Pointing Angle .....	F-27
Figure F-17.	Statgain Pattern .....	F-31
Figure H-1.	The Gaussian Power Spectral Density $S_2(f)$ given by Eq. H-5 for $B_{rms}=2$ Hz.....	H-4
Figure H-2.	The Options for the Power Spectral Density of the Diffuse Component in the Spirent SR5500 Wireless Channel Emulator (Spirent, p. 153).....	H-5

### Table of Tables

Table 2-1.	Telemetry Frequency Allocations.....	2-1
Table 2-2.	CPM Parameters .....	2-5
Table 2-3.	Parameters for the Bessel Filtered NRZ Frequency Pulse.....	2-7
Table 2-4.	SOQPSK-TG Parameters.....	2-10
Table 2-5.	ARTM CPM Dibit to Symbol Mapping .....	2-13
Table 2-6.	Standard Receiver Intermediate Frequency Bandwidths.....	2-18
Table 2-7.	Interference Protection Criteria by Band and Angle of Arrival.....	2-21
Table A-1.	Coefficients for Minimum Frequency Separation Calculation for Uncoded Waveforms.....	A-5
Table A-2.	Coefficients for Minimum Frequency Separation Calculation for Coded Waveforms.....	A-5
Table A-3.	Multipliers for Over-The-Air Bit Rate Calculation .....	A-5
Table A-4.	B99% for Various Digital Modulation Methods .....	A-13

Table A-5.	Characteristics of Various Modulation Methods .....	A-24
Table A-6.	L-Band Frequency Range (10 W, 5 Mbps).....	A-29
Table A-7.	Valid Center Frequency, Band Edge Back-Off .....	A-31
Table B-1.	Constellation Axis Rotations .....	B-3
Table B-2.	Response to Run of 1s.....	B-6
Table B-3.	SOQPSK Pre-Coding Table for IRIG-106 Compatibility .....	B-11
Table B-4.	Script “runDEdemo” Output.....	B-13
Table C-1.	Basic Command Set.....	C-2
Table C-2.	Extended Command Set.....	C-10
Table D-1.	Codeblock Length per Information Block Size .....	D-1
Table D-2.	Submatrix Size per Information Block Size .....	D-2
Table D-3.	Generator Matrix Sizes .....	D-10
Table D-4.	First Rows of Circulants in Generator Matrix, $r=1/2$ , $k=1024$ .....	D-11
Table D-5.	First Rows of Circulants in Generator Matrix, $r=1/2$ , $k=4096$ .....	D-13
Table D-6.	First Rows of Circulants in Generator Matrix, $r=2/3$ , $k=1024$ .....	D-17
Table D-7.	First Rows of Circulants in Generator Matrix, $r=2/3$ , $k=4096$ .....	D-21
Table D-8.	First Rows of Circulants in Generator Matrix, $r=4/5$ , $k=1024$ .....	D-27
Table D-9.	First Rows of Circulants in Generator Matrix, $r=4/5$ , $k=4096$ .....	D-34
Table D-10.	ASM Definition .....	D-43
Table D-11.	Bandwidth Expansion Factor .....	D-44
Table F-1.	Statgain Formulas .....	F-31
Table G-1.	BEP Verses DQM.....	G-1
Table H-1.	Spirent SR5500 Wireless Channel Emulator Settings for Three Paths that Define the Dynamic Multipath Channel for Aeroautical Mobile Telemetry in L-Band .....	H-7
Table H-2.	Spirent SR5500 Wireless Channel Emulator Settings for Three Paths that Define the Dynamic Multipath Channel for Aeroautical Mobile Telemetry in S-Band .....	H-7
Table H-3.	Spirent SR5500 Wireless Channel Emulator Settings for Three Paths that Define the Dynamic Multipath Channel for Aeroautical Mobile Telemetry in C-Band .....	H-8

This page intentionally left blank.

## Acronyms

$\mu\text{V}$	microvolt
AFTRCC	Aerospace and Flight Test Radio Coordinating Council
AM	amplitude modulation
AMT	aeronautical mobile telemetry
ARTM	Advanced Range Telemetry
ASM	attached synchronization marker
AWGN	additive white Gaussian noise
BPSK	binary phase shift keying
BEP	bit error probability
BER	bit error rate
Bi $\phi$	bi-phase
BSS	Broadcasting-Satellite Service
CPM	continuous phase modulation
CCSDS	Consultative Committee for Space Data Systems
dB	decibel
dBc	decibels relative to the carrier
dB <sub>i</sub>	decibels isotropic
dBm	decibels referenced to one milliwatt
dBW	decibels relative to one watt
DoD	Department of Defense
DQE	data quality encapsulation
DQM	data quality metric
EESS	Earth Exploration-Satellite Services
EIRP	effective isotropic radiated power
FCC	Federal Communications Commission
FEC	forward error correction
FM	frequency modulation
FQPSK	Feher's Quadrature Phase Shift Keying
Hz	hertz
IF	intermediate frequency
I/N	interference-to-noise ratio
I/Q	in-phase/quadrature-component
IPC	interference protection criteria
IRIG	Inter-Range Instrumentation Group
ITM	Irregular Terrain Model
kHz	kilohertz
LDPC	low-density parity-check
L-R	Longley-Rice
LTE	Long-Term Evolution
Mbps	megabits per second
MC4EB	Military Command, Control, Communications, and Computers Executive Board
MHz	megahertz
MIL-STD	Military Standard
MSK	minimum shift keying

NRZ-L	non-return-to-zero-level
NTIA	National Telecommunications and Information Administration
OOBE	out-of-band emission
OQPSK	offset quadrature phase shift keying
PAPR	peak-to-average-power-ratio
PCM	pulse code modulation
PFD	power flux density
PM	phase modulation
PSD	power spectral density
QPSK	quadrature phase shift keying
RCC	Range Commanders Council
RF	radio frequency
RLC	resistor-inductor-capacitor
RNRZ	randomized non-return-to-zero
SAW	surface acoustic wave
SDARS	Satellite Digital Audio Radio Service
SHF	super-high frequency
STC	space-time code
SOQPSK	shaped offset quadrature phase shift keying
UHF	ultra-high frequency
US&P	United States and Possessions
VCO	voltage-controlled oscillator
VHF	very-high frequency
WCS	Wireless Communication Service

## CHAPTER 2

### Transmitter and Receiver Systems

#### 2.1 Radio Frequency Standards for Telemetry

These standards provide the criteria to determine equipment and frequency use requirements and are intended to ensure efficient and interference-free use of the radio frequency (RF) spectrum. These standards also provide a common framework for sharing data and providing support for test operations between ranges. The RF spectrum is a limited natural resource; therefore, efficient use of available spectrum is mandatory. In addition, susceptibility to interference must be minimized. Systems not conforming to these standards require justification upon application for frequency assignment, and the use of such systems is highly discouraged. The standards contained herein are derived from the National Telecommunications and Information Administration's (NTIA) Manual of Regulations and Procedures for Federal Radio Frequency Management.<sup>1</sup>

#### 2.2 Bands

The bands used for telemetry are described in [Table 2-1](#).

<b>Table 2-1. Telemetry Frequency Allocations</b>			
<b>Frequency Range (MHz)</b>	<b>Unofficial Designation</b>	<b>Comments</b>	<b>Refer to:</b>
1435-1525	Lower L-band	Telemetry primary service (part of mobile service) in USA	<a href="#">2.2.1</a>
2200-2290	Lower S-band	Telemetry co-primary service in USA	<a href="#">2.2.2</a>
2310-2360	Upper S-band	Wireless Communications Service (WCS) and Broadcasting-Satellite Service (BSS) are primary services. Telemetry is a secondary service in the USA for federal users only in 2310-2320 MHz and 2345-2360 MHz.	<a href="#">2.2.3</a>
2360-2395	Upper S-band	Telemetry primary service in USA	<a href="#">2.2.3</a>
4400-4940	Lower C-band	See Paragraph <a href="#">2.2.4</a>	<a href="#">2.2.4</a>
5091-5150	Middle C-band	See Paragraph <a href="#">2.2.5</a>	<a href="#">2.2.5</a>
5925-6700	Upper C-band	See Paragraph <a href="#">2.2.6</a>	<a href="#">2.2.6</a>

The 1780-1850 MHz band (unofficially called “upper L-band”) can also be used for telemetry at many test ranges, although it is not explicitly listed as a telemetry band in the NTIA Table of Frequency Allocations.<sup>2</sup> The mobile service is a primary service in the 1780-1850 MHz band and telemetry is a part of the mobile service. Since the 1780-1850 MHz band is not considered a standard telemetry band per this document, potential users must coordinate, in advance, with the individual range(s) and ensure use of this band can be supported at the subject

<sup>1</sup> National Telecommunications and Information Administration. “Manual of Regulations and Procedures for Federal Radio Frequency Management.” September 2015. May be superseded by update. Retrieved 17 May 2021. Available at [https://www.ntia.doc.gov/files/ntia/publications/manual\\_sep\\_2015.pdf](https://www.ntia.doc.gov/files/ntia/publications/manual_sep_2015.pdf).

<sup>2</sup> Code of Federal Regulations, Table of Frequency Allocations, title 47, sec. 2.106.

range and that it will meet their technical requirements. While these band designations are common in telemetry parlance, they may have no specific meaning to anyone else. Telemetry assignments are made for testing<sup>3</sup> manned and unmanned aircraft, for missiles, space, land, and sea test vehicles, and for rocket sleds and systems carried on such sleds. Telemetry assignments are also made for testing major components of the aforementioned systems.

#### 2.2.1 Allocation of the Lower L-Band (1435 to 1535 MHz)

This band is allocated in the United States and Possessions (US&P) for government and nongovernmental aeronautical telemetry use on a shared basis. The Aerospace and Flight Test Radio Coordinating Council (AFTRCC) works with the government Area Frequency Coordinators on the non-governmental use of this band. The frequencies in this range will be assigned for aeronautical telemetry and associated remote-control operations<sup>4</sup> for testing of manned or unmanned aircraft, missiles, rocket sleds, and other vehicles or their major components. Authorized usage includes telemetry associated with launching and reentry into the earth's atmosphere as well as any incidental orbiting prior to reentry of manned or unmanned vehicles undergoing flight tests. The following frequencies are shared with flight telemetering mobile stations: 1444.5, 1453.5, 1501.5, 1515.5, and 1524.5 MHz. The frequency range 1435 to 1525 MHz is allocated for the exclusive use of aeronautical telemetry in the United States of America.

#### 2.2.2 Allocation of the Lower S-Band (2200 to 2300 MHz)

No provision is made in this band for the flight testing of manned aircraft.

##### 2.2.2.1 2200 to 2290 MHz

These frequencies are shared equally by the United States Government's fixed, mobile, space research, space operation, and the Earth Exploration-Satellite Services (EESS), and include telemetry associated with launch vehicles, missiles, upper atmosphere research rockets, and space vehicles regardless of their trajectories.

##### 2.2.2.2 2290 to 2300 MHz

Allocations in this range are for the space research service (deep space only) on a shared basis with the fixed and mobile (except aeronautical mobile) services.

#### 2.2.3 Allocation of the Upper S-Band (2310 to 2395 MHz)

This band is allocated to the fixed, mobile, radiolocation, and BSS in the United States of America. Government and nongovernmental telemetry users share portions of this band, chiefly 2360-2390 MHz, in a manner similar to that of the L-band. Telemetry assignments are made for flight-testing of manned or unmanned aircraft, missiles, space vehicles, or their major components.

##### 2.2.3.1 2310 to 2360 MHz

These frequencies have been reallocated and were auctioned by the Federal Communications Commission (FCC) in April 1997. The WCS is the primary service in the frequencies 2305-2320 MHz and 2345-2360 MHz.

---

<sup>3</sup> A telemetry system as defined here is not critical to the operational (tactical) function of the system.

<sup>4</sup> The word used for remote-control operations in this band is *telecommand*.



#### 2.2.3.2 2360 to 2395 MHz

The mobile service (including aeronautical telemetry) is a primary service in this band.

#### 2.2.4 Allocation of the Lower C-Band (4400 to 4940 MHz)

Telemetry is an operation that is currently allowed under the mobile service allocation. Bi-directional telemetry network systems should be operated in the upper part of this band from 4880-4940 MHz. See [Chapter 27](#) Subsection 27.3.1.2 for more information.

#### 2.2.5 Allocation of the Middle C-Band (5091 to 5150 MHz)

Telemetry is an operation that is currently allowed under the mobile service allocation.

#### 2.2.6 Allocation of the Upper C-Band (5925 to 6700 MHz)

This band is not currently allocated as a government band. The process of incorporating federal government use of aeronautical telemetry operations into the NTIA Table of Frequency Allocations for this band has been initiated but not yet completed.

### 2.3 Telemetry Transmitter Systems

Telemetry requirements for air, space, and ground systems are accommodated in the appropriate bands as described in [Section 2.2](#).

#### 2.3.1 Center Frequency Tolerance

Unless otherwise dictated by a particular application, the frequency tolerance for a telemetry transmitter shall be  $\pm 0.002\%$  of the transmitter's assigned center frequency. Transmitter designs shall control transient frequency errors associated with startup and power interruptions. During the first second after turn-on, the transmitter output frequency shall be within the occupied bandwidth of the modulated signal at any time when the transmitter output power exceeds  $-25$  decibels (dB) referenced to one milliwatt (dBm). Between 1 and 5 seconds after initial turn-on, the transmitter frequency shall remain within twice the specified limits for the assigned radio frequency. After 5 seconds, the standard frequency tolerance is applicable for any and all operations where the transmitter power output is  $-25$  dBm or greater (or produces a field strength greater than 320 microvolts [ $\mu$ V]/meter at a distance of 30 meters from the transmitting antenna in any direction). Specific uses may dictate tolerances more stringent than those stated.

#### 2.3.2 Output Power

Emitted power levels shall always be limited to the minimum required for the application. The output power shall not exceed 25 watts<sup>5</sup>. The effective isotropic radiated power (EIRP) shall not exceed 25 watts.

#### 2.3.3 Modulation

The modulations used for aeronautical telemetry, whether analog or digital, have been constant amplitude modulations. Such modulations carry all their information in the phase or instantaneous frequency. Because no information is carried in the amplitude, RF power

---

<sup>5</sup> An exemption from this EIRP limit will be considered; however, systems with EIRP levels greater than 25 watts will be considered nonstandard systems and will require additional coordination with affected test ranges.



amplifiers may operate in full saturation (the most power-efficient mode of operation) and the information is not corrupted by amplitude variations due to transmission.

The standard method for the transmission of digital information is continuous phase modulation (CPM). The three standard modulations are variations of CPM. These three modulations are called pulse code modulation/frequency modulation (PCM/FM), Shaped Offset Quadrature Phase Shift Keying version TG (SOQPSK-TG), and Advanced Range Telemetry CPM (ARTM CPM). Because the characteristics of each are described in CPM terms, this section begins with a technical description of CPM.

### 2.3.3.1 Continuous Phase Modulation

The combination of Equations [2-1](#), [2-2](#), and [2-3](#) define CPM. A carrier signal can be defined as

$$s(t) = A_c \cos(2\pi f_c t + \phi(t)) \quad 2-1$$

$$\phi(t) = 2\pi \sum_i h_i \alpha_i q(t - iT_s) \quad 2-2$$

$$q(t) = \int_{-\infty}^t g(u) du \quad 2-3$$

where  $A_c$  is the constant carrier amplitude,  $f_c$  is the carrier frequency (in Hertz), and  $\phi(t)$  is the time-varying phase that carries the information. The phase is given by Equation [2-2](#), where  $i$  indexes the data symbols,  $h_i$  is the modulation index applied to the  $i$ -th data symbol,  $\alpha_i$  is the  $i$ -th data symbol,  $T_s$  is the symbol time (the reciprocal of the symbol rate), and  $q(t)$  is the phase response. The time-integral of a frequency pulse  $g(t)$  defines the phase response, as shown in Equation [2-3](#).

The length of the frequency pulse  $g(t)$  is an integer multiple of the symbol time  $T_s$ , that is, the frequency pulse spans an integer number of symbols. The number of symbols spanned by the frequency pulse is denoted by  $L$ . If  $L=1$ , then the modulated carrier is called *full response* CPM. If  $L>1$ , then the modulated carrier is called *partial response* CPM. Partial response frequency pulses produce smoother, more gradual phase transitions that reduce the bandwidth of the modulated carrier.

The convention in CPM is to scale the amplitude of the frequency pulse so that it has an area  $1/2$ . As a consequence of this phase response  $q(t)$  may be expressed as

$$q(t) = \begin{cases} 0 & t < 0 \\ \int_0^t g(u) du & 0 \leq t < LT_s \\ 1/2 & t \geq LT_s \end{cases} \quad 2-4$$

Equation [2-4](#) shows that the phase response  $q(t)$  lasts forever.

A CPM signal may be created using an FM modulator in the arrangement shown in [Figure 2-1](#).



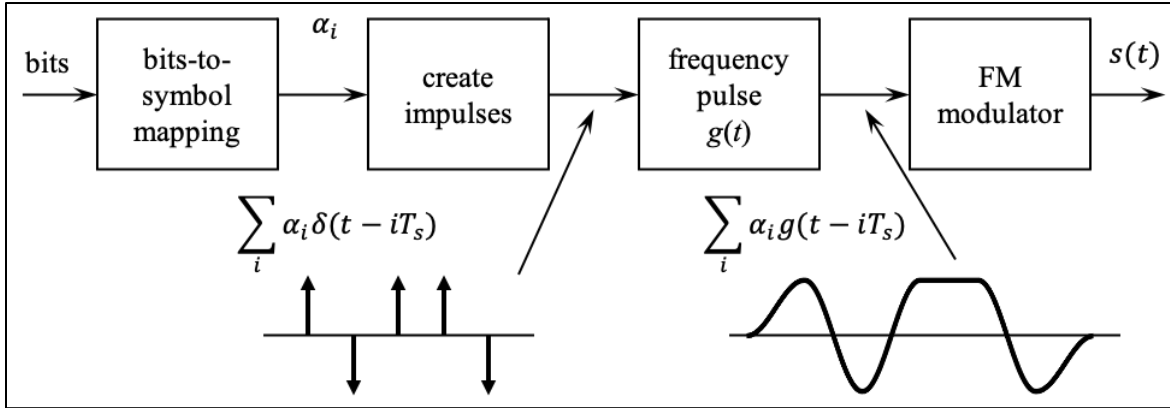

Figure 2-1. A Conceptual CPM Modulator

The diagram illustrates a conceptual method for generating the frequency pulse train that uses a filter whose impulse response is the frequency pulse  $g(t)$  and whose input is a train of weighted impulse functions. The peak frequency deviation of the FM modulator  $\Delta f_i$  applied to the  $i$ -th data symbol  $\alpha_i$  is given by

$$h_i = 2\Delta f_i T_s \tag{2-5}$$

In words, the digital modulation index is two times the peak frequency deviation divided by the symbol rate.

In summary CPM is defined by the set of parameters listed in [Table 2-2](#).

Table 2-2. CPM Parameters		
Name	Symbol	Description
alphabet	$\alpha$	the symbols used to carry digital information
frequency pulse	$g(t)$	frequency pulse with span $L$ symbol times
modulation index(es)	$h$	the ratio of the peak-to-peak frequency deviation to the symbol rate

All three waveforms, PCM/FM, SOQPSK-TG, and ARTM CPM, may all be described using these parameters.

Because the phase response  $q(t)$  lasts forever, CPM is a modulation with memory. Consequently, the optimum detector finds the symbol *sequence* that best matches the received signal. In CPM, the  $i$ -th symbol  $\alpha_i$  advances the phase of the modulated carrier by  $\pi h_i \alpha_i$  radians after  $L$  symbol times. The cumulative contribution of the phase changes is called the phase state and, due to the modulo- $2\pi$  nature of phase and the finite size of the alphabet, there is only a finite number of phase states. During any symbol interval, the CPM waveform is completely defined by the phase state and the  $L-1$  previous symbols. During any symbol interval, the CPM waveform is completely defined by the phase state and the  $L-1$  previous symbols, as the phase state and the  $L-1$  previous symbols comprise the CPM state. The set of possible CPM states forms a finite state machine. Adding the time dimension to the state transitions produces a trellis. The optimum detector, in the maximum likelihood sense, searches the trellis for the CPM state

sequence that most closely matches the received signal. The most commonly used search algorithm is called the Viterbi algorithm.

2.3.3.2 PCM/FM

This modulation has been in use since the 1970s and thus is used in a large number of legacy systems. The CPM parameters for *unfiltered* PCM/FM are



$$\alpha_i = \begin{cases} -1 & i\text{-th bit} = 0 \\ +1 & i\text{-th bit} = 1 \end{cases} \quad 2-6$$

$$h_i = 0.7, \text{ all } i \quad 2-7$$

$$g_1(t) = \begin{cases} \frac{1}{2T_b} & 0 \leq t \leq T_b \\ 0 & \text{otherwise} \end{cases} \quad 2-8$$

When it was adopted, PCM/FM was generated using the technology available. In place of the “create-impulses” block in [Figure 2-1](#), a circuit that created a non-return-to-zero level (NRZ-L) waveform from the bits was used. The FM modulator was usually a voltage-controlled oscillator (VCO).

To reduce the bandwidth of the modulated carrier, a smoother frequency pulse is required. This pulse was created by applying a low-pass filter, called a premodulation filter, to the NRZ-L pulse train. The filter was usually a multi-pole linear phase filter whose  $-3$  dB corner frequency was 0.7 times the bit rate. The concept is illustrated in [Figure 2-2](#).

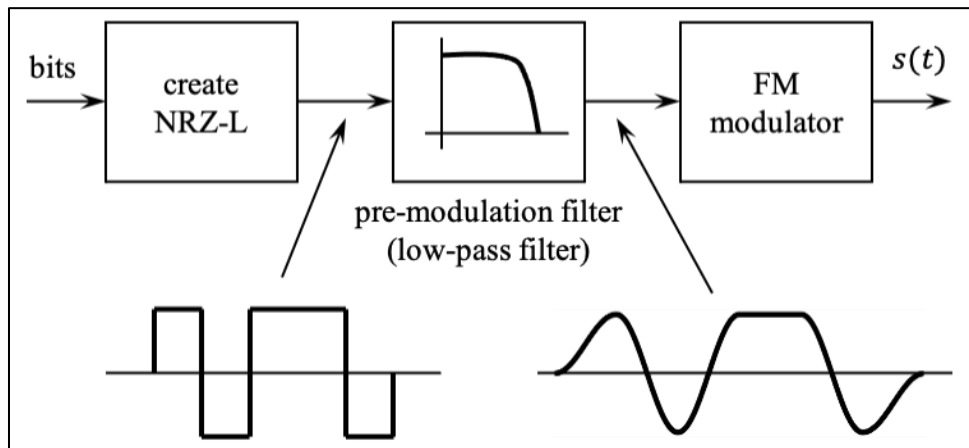

Figure 2-2. PCM/FM Modulator Using a Pre-modulation Filter

The end result is a frequency pulse that is defined as the output of premodulation filter in response to the frequency pulse  $g_1(t)$  in Equation 2-8. The most common continuous-time filter with linear phase is the Bessel filter. The parameters for *filtered* PCM/FM are

$$\alpha_i = \begin{cases} -1 & i\text{-th bit} = 0 \\ +1 & i\text{-th bit} = 1 \end{cases} \quad 2-9$$

$$h_i = 0.7, \text{ all } i \tag{2-10}$$

$$g_2(t) = \begin{cases} A \sum_{n=1}^N \left[ B_n \left( \frac{t}{T_b} \right) - B_n(0) \right] & 0 \leq \frac{t}{T_b} < 1 \\ A \sum_{n=1}^N \left[ B_n \left( \frac{t}{T_b} \right) - B_n \left( \frac{t - T_b}{T_b} \right) \right] & 1 \leq \frac{t}{T_b} \end{cases} \tag{2-11}$$

for an even-ordered Bessel filter and

$$g_2(t) = \begin{cases} A \frac{C_0}{a_0} [1 - e^{a_0(t/T_b)}] + A \sum_{n=1}^N \left[ B_n \left( \frac{t}{T_b} \right) - B_n(0) \right] & 0 \leq \frac{t}{T_b} < 1 \\ A \frac{C_0}{a_0} [e^{a_0(t-T_b)/T_b} - e^{a_0(t/T_b)}] + A \sum_{n=1}^N \left[ B_n \left( \frac{t}{T_b} \right) - B_n \left( \frac{t - T_b}{T_b} \right) \right] & 1 \leq \frac{t}{T_b} \end{cases} \tag{2-12}$$

for an odd-ordered Bessel filter, where

$$B_n(x) = \frac{2C_n e^{a_n b x}}{a_n^2 + \omega_n^2} [(\omega_n \sin(\theta_n) - a_n \cos(\theta_n)) \cos(\omega_n b x) + (a_n \sin(\theta_n) + \omega_n \cos(\theta_n)) \sin(\omega_n b x)] \tag{2-13}$$

$b$  is the -3dB corner frequency relative to the bit rate given by

$$b = 2\pi \times 0.7 \tag{2-14}$$

and where  $A$  is a constant chosen to normalize the area of  $g(t)$  to the standard value of 1/2. The parameters  $C_n$ ,  $a_n$ ,  $\omega_n$ , and  $\theta_n$  for orders 4 – 8 are listed in [Table 2-3](#).

<b>Table 2-3. Parameters for the Bessel Filtered NRZ Frequency Pulse</b>				
<b>Fourth-order Bessel filter (N=2)</b>				
$n$	$C_n$	$a_n$	$\omega_n$	$\theta_n$ (deg)
1	1.321405	-0.995209	1.257106	126.547182
2	4.049108	-1.370068	0.410250	-78.794227
<b>Fifth-order Bessel filter (N=2)</b>				
$n$	$C_n$	$a_n$	$\omega_n$	$\theta_n$ (deg)
0	8.594891	-1.502316	0.717910	-152.010950
1	1.261186	-0.957677	1.471124	60.587298
2	5.568066	-1.380877	0.717910	-152.010950
<b>Sixth-order Bessel filter (N=3)</b>				
$n$	$C_n$	$a_n$	$\omega_n$	$\theta_n$ (deg)
1	1.174080	-0.930657	1.661863	-3.657188

2	7.027081	-1.381858	0.971472	138.041767
3	15.136528	-1.571490	0.320896	-74.465371
<b>Seventh-order Bessel filter (N=3)</b>				
$n$	$C_n$	$a_n$	$\omega_n$	$\theta_n$ (deg)
0	32.675401	-1.684368	0.589245	-146.065944
1	1.070723	-0.909868	1.836451	-66.775408
2	8.331228	-1.378903	1.191567	70.220403
3	23.598522	-1.612039	0.589245	-146.065944
<b>Eighth-order Bessel filter (N=4)</b>				
$n$	$C_n$	$a_n$	$\omega_n$	$\theta_n$ (rads)
1	0.959732	-0.892870	1.998326	-129.100317
2	9.414294	-1.373841	1.388357	3.883967
3	33.701870	-1.636939	0.822796	144.350081
4	60.742083	-1.757408	0.272868	-72.170321

A plot of the frequency pulses is shown in [Figure 2-3](#). The frequency pulses span  $L=3$  symbol times. Consequently, filtered PCM/FM is a partial response CPM. The frequency pulses are more similar than they are different. The different delays shown in the figure are due to the increasing (and more linear) group delay as the order of the Bessel filter increases.

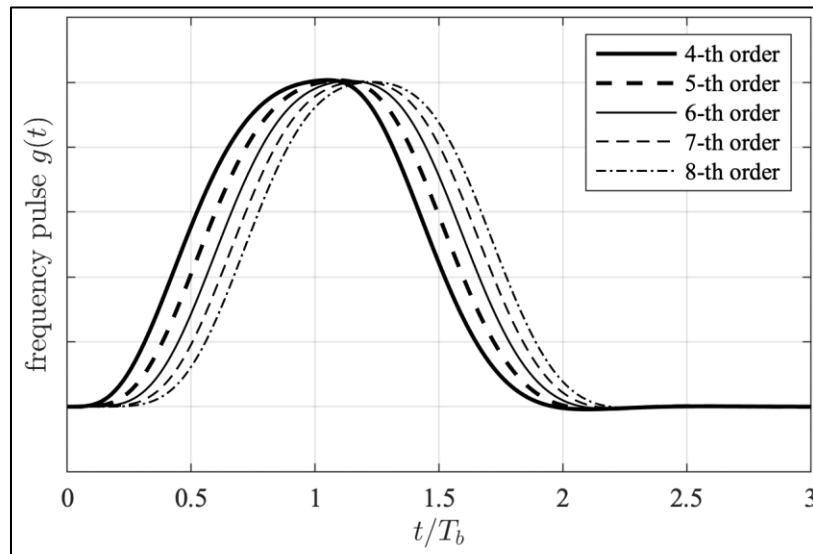

Figure 2-3. Frequency Pulse Shapes Generated by Filtering an NRZ Pulse Shape

In legacy transmitters based only on continuous-time processing, the peak frequency deviation needed to be carefully measured and was set by hand. Modern modulators often use discrete-time processing to create sampled versions of the waveforms and do not suffer from this problem.

The optimum detector is the trellis-based detector described in Subsection [2.3.3.1](#). However, the technology of the day could not perform the computations required to implement optimum detection. Consequently, the most common detectors in use from the early 1970s to the early 2000s were based on limiter-discriminators to produce a noisy version of the waveform

$$\frac{d}{dt}\phi(t) = 2\pi h \sum_i \alpha_i g(t - iT_b) \quad 2-15$$

The limiter-discriminator output was connected to a timing phase-lock-loop circuit (commonly called a bit synchronizer) to recover the clock and underlying bit sequence. As technology advanced, optimum detection based on a trellis search became feasible. However, optimum detection requires the modulation index to be precisely  $h=0.7$ , which can be difficult to achieve using legacy modulators as described above. The trellis-based detectors currently available accommodate small variations in the modulation index at the cost of modest reductions in detection efficiency.

### 2.3.3.3 SOQPSK-TG

This modulation was introduced to this standard in 2004 as a more bandwidth-efficient alternative to PCM/FM. It is a partial response CPM with a constrained ternary alphabet. The frequency pulse is a spectral raised-cosine pulse windowed by a modified temporal raised-cosine function. The CPM parameters of SOQPSK-TG are

$$a_i = \begin{cases} -1, & i\text{-th bit} = 0 \\ +1, & i\text{-th bit} = 1 \end{cases} \quad 2-16$$

$$\alpha_i = (-1)^{i+1} \frac{a_{i-1}(a_i - a_{i-2})}{2} \quad 2-17$$

$$h_i = 0.5, \text{ all } i \quad 2-18$$

$$g(t) = \left[ \frac{A \cos\left(\frac{\pi\rho Bt}{2T_b}\right)}{1 - 4\left(\frac{\rho Bt}{2T_b}\right)^2} \right] \left[ \frac{\sin\left(\frac{\pi Bt}{2T_b}\right)}{\frac{\pi Bt}{2T_b}} \right] w(t) \quad 2-19$$

where the window  $w(t)$  is

$$w(t) = \begin{cases} 1 & |t/2T_b| \leq T_1 \\ \frac{1}{2} + \frac{1}{2} \cos\left(\frac{\pi\left(\left|\frac{t}{2T_b}\right| - T_1\right)}{T_2}\right) & T_1 < |t/2T_b| \leq T_1 + T_2 \\ 0 & |t/2T_b| > T_1 + T_2 \end{cases} \quad 2-20$$

Equation [2-17](#) is a precoder that converts binary symbols in the set  $\{-1,+1\}$ , to ternary symbols in the set  $\{-1,0,+1\}$ . The ternary symbol sequence is constrained. The purpose of this precoder is discussed below in the context of detection. A new bit occurs every  $T_b$  seconds. The precoder produces a new ternary symbol every  $T_b$  seconds.

The SOQPSK-TG frequency pulse is illustrated in [Figure 2-4](#).

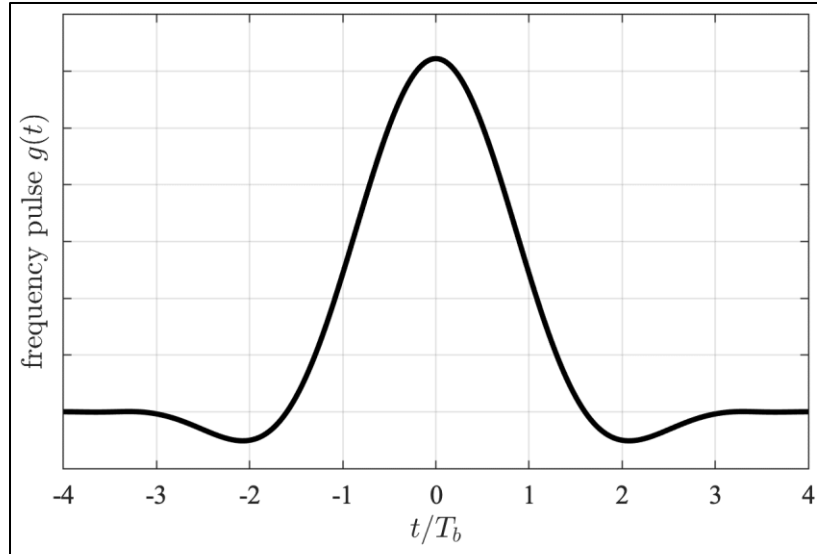

Figure 2-4. The Frequency Pulse for SOQPSK-TG

Observe that the independent time variable in the plot is  $-4T_b \leq t \leq 4T_b$  and follows from the way the frequency pulse is defined in Equations [2-19](#) and [2-20](#). The frequency pulse is not really non-causal; the mathematical expressions are more convenient when the time variable is centered at zero. The frequency pulse spans  $L=8$  bit times. The constant  $A$  in Equation [2-19](#) is chosen to normalize the area of  $g(t)$  to the standard value of  $1/2$ :

$$\int_{-(T_1+T_2)2T_b}^{(T_1+T_2)2T_b} g(t)dt = \frac{1}{2} \quad 2-21$$

There are four other parameters in Equations [2-19](#) and [2-20](#) that define the frequency pulse:  $\rho, B, T_1, T_2$ . Adjusting these parameters produces a trade-off between spectral efficiency and detection efficiency. The -TG version of SOQPSK is defined by the parameters listed in [Table 2-4](#).

<b>Table 2-4. SOQPSK-TG Parameters</b>				
Parameter	$\rho$	$B$	$T_1$	$T_2$
Value	0.70	1.25	1.5	0.5

The frequency pulse is a complicated pulse shape that is not easily approximated by applying a continuous-time low-pass filter to an NRZ-L pulse train. Consequently, most transmitters use sophisticated digital signal processing techniques to generate a discrete-time version of the input to the FM modulator.



The optimum detector is the trellis-based detector described in Subsection 2.3.3.1 and a number of reduced-complexity versions with very good performance have been developed.<sup>6,7</sup> When SOQPSK-TG was adopted, its interoperability with offset QPSK (OQPSK) was an important consideration. It is well known that CPM with a binary alphabet and with  $h=5$  is closely related to OQPSK<sup>8</sup>. This relationship is illustrated by the eye diagrams formed by the inphase and quadrature components of SOQPSK-TG illustrated in Figure 2-5. In this plot, the equivalent OQPSK symbol time  $T_s = 2T_b$  is used for the time axis. The figure shows that sampling the inphase and quadrature components of SOQPSK-TG at the instants corresponding to the maximum eye openings can be used to recover the data. Note that the time instants for the inphase and quadrature components are offset by  $T_s/2$  relative to each other.

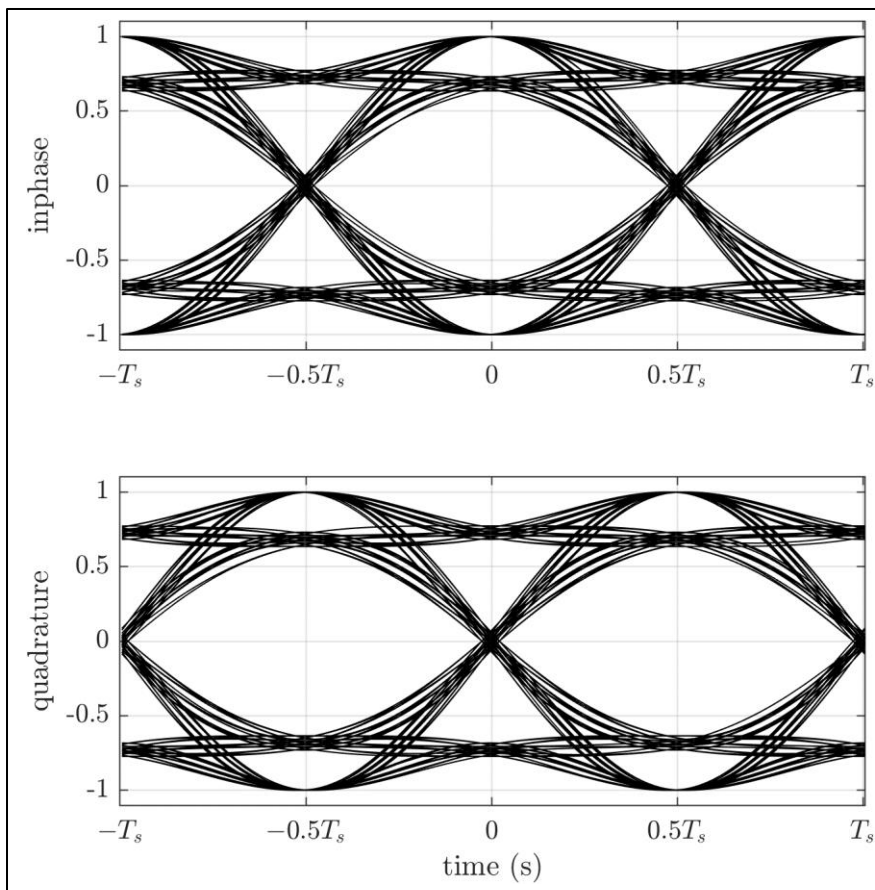

Figure 2-5. Eye Diagrams for the Inphase (Top) and Quadrature (Bottom) Components of SOQPSK-TG

For a generic CPM with a binary alphabet and  $h=5$ , the relationship to OQPSK follows from the fact that each binary symbol changes the CPM phase by  $\pi/2$  rads. Because of the cumulative phase memory in CPM, the phase state must be tracked to recover the data. The

<sup>6</sup> Mark Geoghegan. "Implementation and Performance Results for Trellis Detection of SOQPSK." In *Proceedings of the International Telemetry Conference*, Las Vegas, NV, October 2001.

<sup>7</sup> Perrins, E. and M. Rice. "Reduced-Complexity Approach to Iterative Detection of Coded SOQPSK." *IEEE Transactions on Communications*, vol 55, no. 7, pp 1354-1362, July 2007.

<sup>8</sup> P. Laurent. "Exact and Approximate Construction of Digital Phase Modulations by Superposition of Amplitude Modulated Pulses (AMP)." *IEEE Transactions on Communications*, vol. 34, no. 2, pp. 150-160, February 1986.

precoder in Equation 2-17 removes the cumulative phase memory from SOQPSK-TG and permits symbol-by-symbol detection using an OQPSK detector with a detection filter in place of a matched filter.<sup>9,10</sup> The precoder converts the phase *shift* normally associated with a CPM symbol to an *absolute* phase as in OQPSK.

The benefits of the precoder (symbol-by-symbol detection) are achieved at the cost of a 90° phase ambiguity exists in the recovered carrier phase reference when using decision directed techniques. To allow correct detection in the presence of the 90° phase ambiguity, differential encoding is applied to the bits prior to the precoder given by Equation 2-17. The differential encoder<sup>11</sup> operates on user bit pairs ( $b_{2i}, b_{2i+1}$ ) to produce a pair of differentially encoded bits ( $\delta_{2i}, \delta_{2i+1}$ ). The differential encoding operation is defined by

$$\begin{aligned}\delta_{2i} &= b_{2i} \oplus \bar{\delta}_{2i-1} \\ \delta_{(2i+1)} &= b_{(2i+1)} \oplus \delta_{2i}\end{aligned}\tag{2-22}$$

where the bits are their “logical values”  $b_{2i}, b_{2i+1} \in \{0,1\}$ ,  $\oplus$  is the Boolean exclusive or operation, and  $\bar{\delta}_{2i-1}$  is the logical complement of  $\delta_{2i-1}$ . The corresponding differential decoder must be applied to the bit decisions at the detector output. The differential decoder operates on pairs of differential encoded bits ( $\delta_{2i}, \delta_{2i+1}$ ) to produce a pair of user bits ( $b_{2i}, b_{2i+1}$ ). The differential decoder is defined by

$$\begin{aligned}b_{2i} &= \delta_{2i} \oplus \bar{\delta}_{2i-1} \\ b_{2i+1} &= \delta_{2i+1} \oplus \delta_{2i}\end{aligned}\tag{2-23}$$

A block diagram illustrating the inclusion of the differential encoder in an SOQPSK-TG modulator is shown in Figure 2-6.

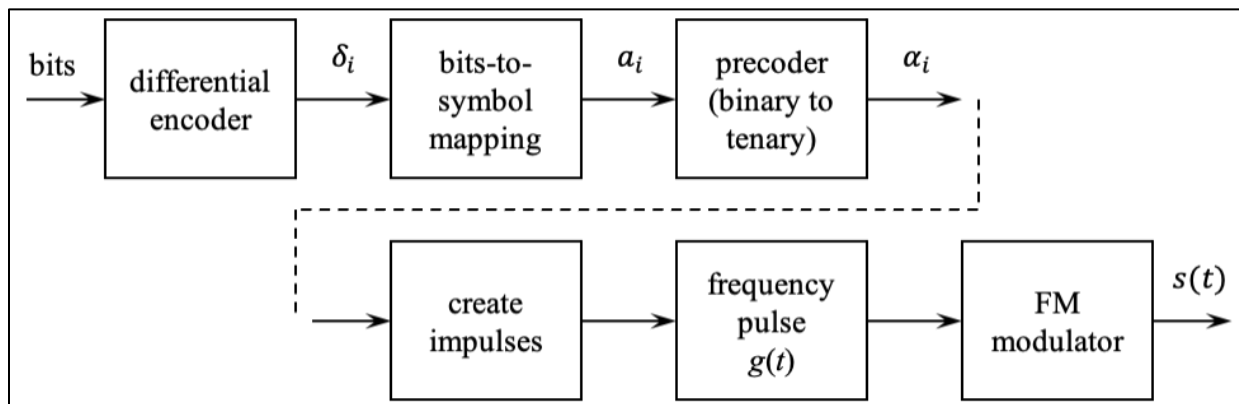

Figure 2-6. Block Diagram of an SOQPSK-TG Modulator Showing the Placement of the Differential Encoder

<sup>9</sup> Mark Geoghegan. “Optimal Linear Detection of SOQPSK.” In *Proceedings of the International Telemetry Conference*, San Diego, CA, October 2002.

<sup>10</sup> E. Perrins, “FEC Systems for Aeronautical Telemetry.” *IEEE Transactions on Aerospace and Electronic Systems*, vol 49, no. 4, pp 2340-2352, October 2013.

<sup>11</sup> A more detailed description of the differential encoder and decoding, including some encoding and decoding examples, is found in [Appendix 2-B](#).

There is an alternative description<sup>12</sup> of SOQPSK-TG based on a longer frequency pulse but eliminates the need for the precoder (Equation 2-18) (and the resulting constrained ternary alphabet) and the differential encoder (Equation 2-22).

2.3.3.4 ARTM CPM

This modulation was introduced to this standard in 2007 as a more bandwidth-efficient alternative to SOQPSK-TG. It is a partial response CPM with a quaternary alphabet, two alternating modulation indexes, and a temporal raised-cosine frequency pulse. The CPM parameters of ARTM CPM are



$$\alpha_i \in \{-3, -1, +1, +3\} \text{ according to Table 2-5} \tag{2-24}$$

$$h_i = \begin{cases} 4/16 & i \text{ even} \\ 5/16 & i \text{ odd} \end{cases} \tag{2-25}$$

$$g(t) = \begin{cases} \frac{1}{6T_s} \left[ 1 - \cos\left(\frac{2\pi t}{3T_s}\right) \right] & 0 \leq t \leq 3T_s \\ 0 & \text{otherwise.} \end{cases} \tag{2-26}$$

Table 2-5. ARTM CPM Dibit to Symbol Mapping	
Input Dibit $[b_{2i}, b_{2i+1}]$	Symbol value $\alpha_i$
0 0	-3
0 1	-1
1 0	+1
1 1	+3

Because the symbols are quaternary, two bits (called a *dibit*) define a symbol. A new bit is input every  $T_b$  seconds. A quaternary symbol is output every  $T_s = 2T_b$  seconds. A plot of the frequency pulse is shown in Figure 2-7. The frequency pulse spans  $L=3$  symbol times and has area 1/2.

<sup>12</sup> Perrins, E. and M. Rice. "Unification of Signal Models for SOQPSK." In *Proceedings of the International Telemetry Conference*, Glendale, AZ, 5-8 November 2018.

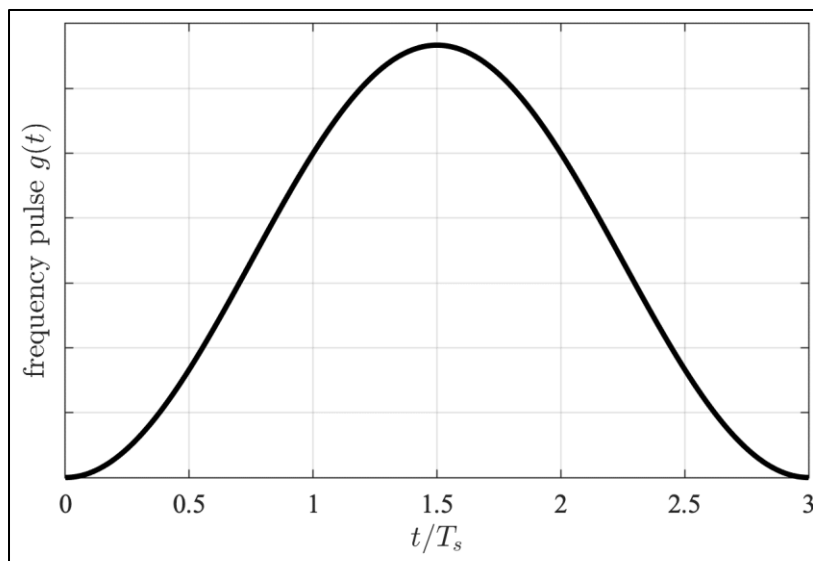

Figure 2-7. The Frequency Pulse for ARTM CPM

The frequency pulse could be approximated by applying a continuous-time low-pass filter to an NRZ-L pulse train. Unfortunately, the alternating modulation indexes and strict spectral containment requirements render the approximate approach unusable. Consequently, transmitters use sophisticated digital signal processing techniques to generate a discrete-time version of the input to the FM modulator.

The optimum detector is the trellis-based detector described in Subsection [2.3.3.1](#). The trellis associated with the optimum detector possesses a large number of states. Reduced-complexity detectors for ARTM CPM have been described and analyzed.<sup>13</sup>

#### 2.3.3.5 Data Randomization

The data input to the transmitter shall be randomized using either an encryptor that provides randomization or an Inter-Range Instrumentation Group (IRIG) 15-bit randomizer as described in [Chapter 6](#) and [Annex A.2](#). The purpose of the randomizer is to prevent degenerative data patterns from degrading data quality.

#### 2.3.3.6 Bit Rate

Bit rate is defined as the over-the-air bit rate which includes any and all added overhead associated with coding. Without coding the input bit rate to the transmitter equals the output bit rate.

#### 2.3.3.7 Transmitter Phase Noise

The sum of all discrete spurious spectral components (single-sideband) shall be less than  $-36$  dBc. The continuous single-sideband phase noise power spectral density (PSD) shall be below the curve shown in [Figure 2-8](#). The maximum frequency for the curve is one-fourth of the bit rate. For bit rates greater than 4 megabits per second (Mbps), the phase noise PSD shall be less than  $-100$  dBc/hertz (Hz) between 1 MHz and one-fourth of the bit rate.

<sup>13</sup> Perrins, E. and M. Rice. "Reduced-complexity Detectors for Multi-h CPM in Aeronautical Telemetry." In *IEEE Transactions on Aerospace and Electronic Systems*, vol. 40, no. 1, pp. 286-300, January 2007.

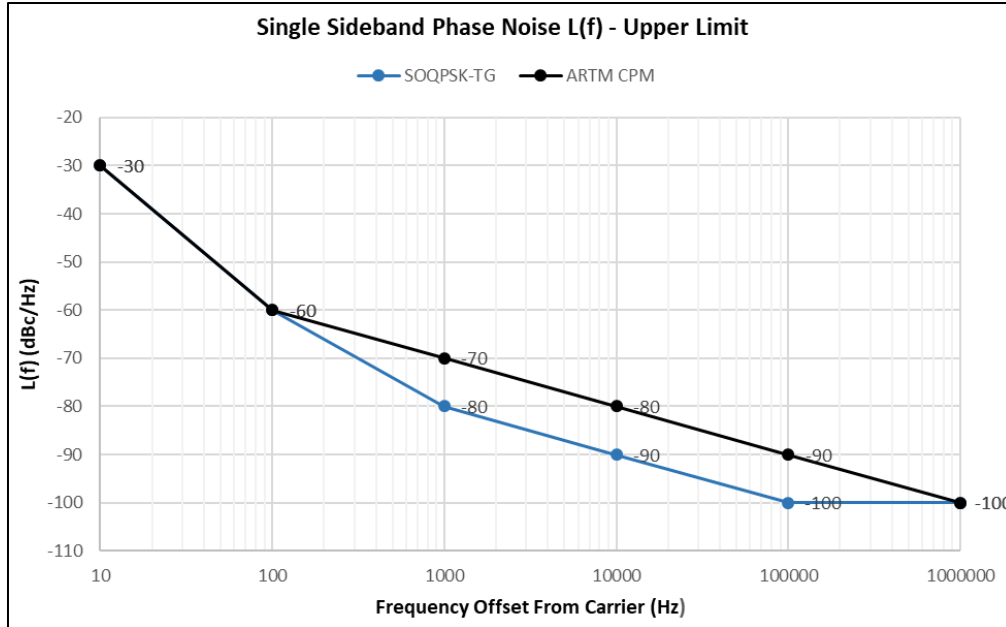

Figure 2-8. Continuous Single-Sideband Phase Noise Power Spectral Density

### 2.3.3.8 Modulation Polarity

An increasing voltage at the input of an FM transmitter shall cause an increase in output carrier frequency. An increase in voltage at the input of a phase modulation (PM) transmitter shall cause an advancement in the phase of the output carrier. An increase in voltage at the input of an amplitude modulation (AM) transmitter shall cause an increase in the output voltage of the output carrier.

### 2.3.4 Spurious Emission and Interference Limits

Spurious<sup>14</sup> emissions from the transmitter case, through input and power leads, and at the transmitter RF output and antenna-radiated spurious emissions are to be within required limits shown in Military Standard (MIL-STD)-461,<sup>15</sup> CE106 with the following clarifications.

- Harmonics (except the second and third) and all other spurious emissions shall be at least 80 dB down from the level of the fundamental, which is equal to  $-80$  dBc.
- The second and third harmonics shall be suppressed to a limit of  $-25$  dBm.
- Spurious emission limits are not applicable within the bandwidth of the transmitted signal defined in Subsection [2.3.6](#).
- Testing shall occur with a modulated carrier.

#### 2.3.4.1 Transmitter-Antenna System Emissions

Emissions from the antenna are of primary importance. For example, a tuned antenna may or may not attenuate spurious frequency products produced by the transmitter, and an

<sup>14</sup> Any unwanted signal or emission is spurious whether or not it is related to the transmitter frequency (harmonic).

<sup>15</sup> Department of Defense. "Requirements for the Control of Electromagnetic Interference Characteristics of Subsystems and Equipment." MIL-STD-461-G. 11 December 2015. May be superseded by update. Retrieved 17 May 2021. Available at [https://quicksearch.dla.mil/qsDocDetails.aspx?ident\\_number=35789](https://quicksearch.dla.mil/qsDocDetails.aspx?ident_number=35789).

antenna or multi-transmitter system may generate spurious outputs when a pure signal is fed to its input. The transmitting pattern of such spurious frequencies is generally different from the pattern at the desired frequency. Antenna-radiated spurious outputs shall be no greater than 320  $\mu\text{V}/\text{meter}$  at 30 meters in any direction, which is equal to  $-25\text{ dBm}$  when cable losses plus antenna gain are assumed to be unity.

<b>WARNING</b>	Spurious levels of $-25\text{ dBm}$ may severely degrade performance of sensitive receivers whose antennas are located in close proximity to the telemetry transmitting antenna. Therefore, lower spurious levels may be required in certain frequency ranges, such as near Global Positioning System frequencies.
----------------	--

#### 2.3.4.2 Conducted and Radiated Interference

Interference (and the RF output itself) radiated from the transmitter or fed back into the transmitter power, signal, or control leads could interfere with the normal operation of the transmitter or the antenna system to which the transmitter is connected. All signals conducted by the transmitter's leads (other than the RF output cable) in the range of 150 kilohertz (kHz) to 50 MHz and all radiated fields in the range of 150 kHz to 10 gigahertz (GHz) (or other frequency ranges as specified) must be within the limits of the applicable standards or specifications.

#### 2.3.5 Operational Flexibility

Each transmitter shall be capable of operating at all frequencies within its allocated band without design modification.<sup>16</sup>

#### 2.3.6 Modulated Transmitter Bandwidth<sup>17</sup>

Telemetry applications covered by this standard shall use 99-percent power bandwidth to define occupied bandwidth and  $-25\text{ dBm}$  bandwidth as the primary measure of spectral efficiency. The  $-25\text{ dBm}$  bandwidth is the minimum bandwidth that contains all spectral components that are  $-25\text{ dBm}$  or larger. A power level of  $-25\text{ dBm}$  is exactly equivalent to an attenuation of the transmitter power by  $55 + 10 \times \log(P)\text{ dBc}$  where P is the transmitter power expressed in watts. The spectra are assumed symmetrical about the transmitter's center frequency unless specified otherwise. All spectral components larger than  $-(55 + 10 \times \log(P))\text{ dBc}$  at the transmitter output must be within the spectral mask calculated using the following equation:

$$M(f) = K + 90 \log R - 100 \log |f - f_c|; |f - f_c| \geq \frac{R}{m} \quad 2-27$$

where  $M(f)$  = power relative to P (i.e., units of dBc) at frequency f (MHz)

K =  $-20$  for analog signals

=  $-28$  for binary signals

=  $-61$  for SOQPSK-TG

=  $-73$  for ARTM CPM

$f_c$  = transmitter center frequency (MHz)

<sup>16</sup> The intent is that fixed-frequency transmitters can be used at different frequencies by changing crystals or other components. All applicable performance requirements will be met after component change.

<sup>17</sup> These bandwidths are measured using a spectrum analyzer with the following settings: 30-kHz resolution bandwidth, 300-Hz video bandwidth, and no max hold detector or averaging.

$R$  = bit rate (Mbps) for digital signals or  $(\Delta f + f_{\max})$  (MHz) for analog FM signals  
 $m$  = number of states in modulating signal  
 $m = 2$  for binary signals  
 $m = 4$  for quaternary signals and analog signals  
 $\Delta f$  = peak deviation  
 $f_{\max}$  = maximum modulation frequency

Note that the mask in this standard is different than the masks contained in earlier versions of the Telemetry Standards. Equation [2-27](#) does not apply to spectral components separated from the center frequency by less than  $R/m$ . The  $-25$  dBm bandwidth is not required to be narrower than 1 MHz. Binary signals include all modulation signals with two states while quaternary signals include all modulation signals with four states (quadrature phase shift keying [QPSK] is one example of four-state signals). Section [A.6](#) contains additional discussion and examples of this spectral mask.

### 2.3.7 Valid Center Frequencies Near Telemetry Band Edges

The telemetry bands, as specified, start and stop at discrete frequencies. Telemetry transmitters transmitting PCM/FM, SOQPSK-TG, or ARTM CPM, even with optimal filtering, do not have discrete start and stop frequencies. In order to determine a valid carrier frequency, the transmitter power, modulation scheme, and data rate must be known. The distance, in frequency, from the point in which the spectral masks, as described in Subsection [2.3.6](#), intersect the absolute value of  $-25$  dBm equals the amount in which the transmitter carrier frequency must be from the band edge frequency. Subsection [A.11](#) contains additional discussion and examples of center frequency determination when operating near telemetry band edges.

## 2.4 Telemetry Receiver Systems

As a minimum, receiver systems shall have the following characteristics.

### 2.4.1 Spurious Emissions

The RF energy radiated from the receiver itself or fed back into the power supply, and/or the RF input, output, and control leads in the range from 150 kHz to 10 GHz shall be within the limits specified in MIL-STD-461. The receiver shall be tested in accordance with MIL-STD-461 or RCC Document 118, Volume II.<sup>18</sup> Other applicable standards and specifications may be used in place of MIL-STD-461, if necessary.

### 2.4.2 Frequency Tolerance

The accuracy of all local oscillators within the receiver shall be such that the conversion accuracy at each stage and overall is within  $\pm 0.001$  percent of the indicated tuned frequency under all operating conditions for which the receiver is specified.

### 2.4.3 Receiver Phase Noise

The sum of all discrete spurious spectral components (single-sideband) shall be less than  $-39$  dBc. The continuous single-sideband phase noise PSD shall be 3 dB below the curve shown in [Figure 2-8](#). The maximum frequency for the curve in [Figure 2-8](#) is one-fourth of the bit rate.

---

<sup>18</sup> Range Commanders Council. *Test Methods for Telemetry Systems and Subsystems Volume 2*. RCC 118-20. June 2020. May be superseded by update. Retrieved 17 May 2021. Available at <https://www.trmc.osd.mil/wiki/x/flu8Bg>.

For bit rates greater than 4 Mbps, the phase noise PSD shall be less than  $-103$  dBc/Hz between 1 MHz and one-fourth of the bit rate.

2.4.4 Spurious Responses

Rejection of any frequency other than the one to which the receiver is tuned shall be a minimum of 60 dB referenced to the desired signal over the range 150 kHz to 10 GHz.

2.4.5 Operational Flexibility

All ground-based receivers shall be capable of operating over the entire band for which they are designed. External down-converters may be either intended for the entire band or a small portion but capable of retuning anywhere in the band without modification.

2.4.6 Intermediate Frequency Bandwidths

The standard receiver intermediate frequency (IF) bandwidths are shown in [Table 2-6](#). These bandwidths are separate from and should not be confused with post-detection low-pass filtering that receivers provide.<sup>19</sup> The ratio of the receiver’s  $-60$  dB bandwidth to the  $-3$  dB bandwidth shall be less than 3 for new receiver designs.

<b>Table 2-6. Standard Receiver Intermediate Frequency Bandwidths</b>		
300 kHz	1.5 MHz	6 MHz
500 kHz	2.4 MHz	10 MHz
750 kHz	3.3 MHz	15 MHz
1000 kHz	4.0 MHz	20 MHz

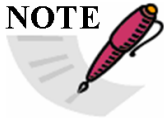
 <p><b>NOTE</b></p>	<ol style="list-style-type: none"> <li>1. For data receivers, the IF bandwidth should typically be selected so that 90 to 99 percent of the transmitted spectrum is within the receiver 3 dB bandwidth. In most cases, the optimum IF bandwidth will be narrower than the 99 percent power bandwidth.</li> <li>2. Bandwidths are expressed at the points where response is 3 dB below the response at the design center frequency, assuming that passband ripple is minimal, which may not be the case. The 3-dB bandwidth is chosen because it closely matches the noise bandwidth of a “brick-wall” filter of the same bandwidth. The “optimum” bandwidth for a specific application may be other than that stated here. Ideal IF filter response is symmetrical about its center frequency; in practice, this may not be the case.</li> <li>3. Not all bandwidths are available on all receivers or at all test ranges. Additional receiver bandwidths may be available at some test ranges, especially if the range has receivers with digital IF filtering</li> </ol>
--	--

2.4.7 C-band Downconversion

For telemetry receive systems employing C-band downconversion, the following mapping of C-band RF to C-band IF frequencies is recommended for the lower C and middle C bands. This downconversion scheme utilizes a high-side local oscillator frequency of 5550 MHz

<sup>19</sup> In most instances, the output low-pass filter should *not* be used to “clean up” the receiver output prior to use with demultiplexing equipment.



to minimize the potential of mixing products interfering with received telemetry signals. Additionally, using a standardized approach fosters interoperability between manufacturers of telemetry antenna systems employing downconversion and manufacturers of telemetry receivers with C-IF tuners.

No recommendation will be made at this point for the downconversion of the upper C band (5925-6700 MHz).

Examples:

$$\text{C-IF Frequency} = (5550 \text{ MHz} - \text{C-RF Frequency})$$

$$1150 \text{ MHz} = (5550 \text{ MHz} - 4400 \text{ MHz})$$

$$610 \text{ MHz} = (5550 \text{ MHz} - 4940 \text{ MHz})$$

$$459 \text{ MHz} = (5550 \text{ MHz} - 5091 \text{ MHz})$$

$$400 \text{ MHz} = (5550 \text{ MHz} - 5150 \text{ MHz})$$

## 2.5 Codes for Telemetry Systems

### 2.5.1 Low-Density Parity-Check Code

Forward error correction (FEC) is a way of adding additional information to a transmitted bit stream in order to decrease the required signal-to-noise ratio to the receiver for a given bit error rate (BER). Low-density parity-check (LDPC) code is a block code, meaning that a block of information bits has parity added to them in order to correct for errors in the information bits. The term “low-density” stems from the parity check matrix containing mostly 0’s and relatively few 1’s. This specific LDPC variant comes from the satellite link community and is identical to the Accumulate-Repeat-4-Jagged-Accumulate code described by the Consultative Committee for Space Data Systems (CCSDS) standard 131.1-O-2-S.1,<sup>20</sup> which describes nine different LDPC codes with different coding rates (rate 1/2, 2/3, 4/5) and information block sizes (1024, 4096, 16384). In the trade between the transmission channel characteristics, bandwidth efficiency, coding gain, and block size all three rates and block sizes 1024 and 4096 are considered in this standard. Additional information on this LDPC code is contained in [Appendix 2-D](#).

### 2.5.2 Space-Time Code

As the name suggests, this code uses space diversity and time diversity to overcome the two-antenna problem, which is characterized by large variances in the antenna gain pattern from a test article caused by transmitting the same telemetry signal time through two transmit antennas. These signals are typically delayed in time and have differing amplitudes. The space-time code (STC) in this standard applies to only SOQPSK-TG modulation. The input bit stream is space-time coded, resulting in two parallel bit streams that then have a pilot sequence added to each at fixed bit intervals (or blocks). These encoded/pilot-added streams are then individually modulated through phase-locked transmitters to a carrier using SOQPSK-TG modulation, power amplified, then connected to a top and bottom antenna. The job of estimating frequency offset, delays, gains, and phase shifts due to the transmission channel then space-time decode the signal is done with the STC receiver. Additional information on the STC is contained in [Appendix 2-E](#).

<sup>20</sup> Consultative Committee for Space Data Systems. *Low Density Parity Check Codes for Use in Near-Earth and Deep Space Applications*. Standard CCSDS 131.1-O-2-S. September 2007. Rescinded. Retrieved 17 May 2021. Available at <https://public.ccsds.org/Pubs/131x1o2e2s.pdf>.

## 2.6 Randomization Methods for Telemetry Systems

### 2.6.1 Introduction

The following randomization and de-randomization methods are recommended for wireless serial streaming telemetry data links. The choice of randomization method used should be based on whether or not a self-synchronizing randomizer is required for the application.

### 2.6.2 Randomizer Types

#### 2.6.2.1 Self-Synchronizing Randomizers

Self-synchronizing randomizers, such as the traditional IRIG randomizer described in [Annex A.2](#), work best when there are no known identifiers in the bit stream to aid in synchronizing the de-randomizer. This type of de-randomizer has the characteristic of creating additional bit errors when a bit error is received at the de-randomizer input. For this randomizer a single bit error at the input will create an additional two bit errors in the output stream. This BER extension will cause a degradation in detection efficiency of the link of approximately 0.5 dB.

#### 2.6.2.2 Non-Self-Synchronizing Randomizers

Non-self-synchronizing randomizers, such as the CCSDS randomizer described in [Appendix 2-D](#), do not create additional bit errors when a bit error is received at the de-randomizer input. Therefore there is no extension of BER; however, these types of randomizers need to be synchronized with the incoming bit stream. This is usually accomplished through the use of pilot bits or synchronization markers in the data stream to aid in synchronization. Performance of this type of randomizer will exceed that of a self-synchronizing randomizer lending itself as a better choice for coded links or links requiring data-aided synchronization.

### 2.6.3 Randomizer Application

As defined in [Appendix 2-D](#), CCSDS randomization should be used for coded links such as LDPC links or links exhibiting a block structure with synchronization markers.

Traditional IRIG randomization as defined in [Annex A.2](#) should be used for non-encrypted links that are absent of synchronization markers or do not contain markers of any type. Encrypted telemetry links do not require randomization.

## 2.7 Data Quality Metrics and Data Quality Encapsulation

A reliable metric for estimating data quality can be very useful when controlling telemetry data processing equipment, such as Best Source Selectors, that require an understanding of received data quality in order to operate effectively. To accomplish this, a standardized method for estimating bit error probability (BEP) is needed. In addition to the metric, a standardized method for transporting the metric with the associated data is required. [Appendix 2-G](#) provides a standard for a data quality metric (DQM), determined in the telemetry receiver demodulator, and a standard for data quality encapsulation (DQE) allowing for transport of the received telemetry data and associated DQM.

## 2.8 Interference Protection Criteria for Aeronautical Mobile Telemetry Systems

Aeronautical mobile telemetry (AMT) ground stations use very high gain directional antenna systems that are sensitive to interference from other RF communication systems.

Without appropriate interference protection, these systems could be severely impacted or even rendered useless for mission support. To prevent this from happening, appropriate interference protection criteria (IPC) are needed.

[Table 2-7](#) lists the acceptable power flux density (PFD) levels for interference in each telemetry band. These levels are based on the well-established and accepted IPC contained in International Telecommunications Union Radio Service (ITU-R) Recommendation M.1459<sup>21</sup> (Rec M.1459). These IPCs provide AMT protection for aggregate interference from satellites and terrestrial emitters as a function of the angle of arrival  $\alpha$  of the interfering signal(s) at or above the horizon derived using the methodology given in Annex A of Rec M.1459.

<b>Table 2-7. Interference Protection Criteria by Band and Angle of Arrival</b>		
<b>L band, from 1435 – 1535 MHz</b>		
-181.0	dB(W/m <sup>2</sup> ) in 4 kHz	for $0 \leq \alpha \leq 4^\circ$
$-193.0 + 20 \log \alpha$	dB(W/m <sup>2</sup> ) in 4 kHz	for $4 < \alpha \leq 20^\circ$
$-213.3 + 35.6 \log \alpha$	dB(W/m <sup>2</sup> ) in 4 kHz	for $20 < \alpha \leq 60^\circ$
-150.0	dB(W/m <sup>2</sup> ) in 4 kHz	for $60 < \alpha \leq 90^\circ$
<b>Upper L band, from 1755 – 1855 MHz</b>		
-181.0	dB(W/m <sup>2</sup> ) in 4 kHz	for $0^\circ \leq \alpha \leq 3^\circ$
$-190.878 + 21.948 \log \alpha$	dB(W/m <sup>2</sup> ) in 4 kHz	for $3^\circ < \alpha \leq 15^\circ$
$-185.722 + 18.286 \log \alpha$	dB(W/m <sup>2</sup> ) in 4 kHz	for $15^\circ < \alpha \leq 60^\circ$
-153.7	dB(W/m <sup>2</sup> ) in 4 kHz	for $60^\circ < \alpha \leq 90^\circ$
<b>Lower S band, from 2200 – 2290 MHz</b>		
-180.0	dB(W/m <sup>2</sup> ) in 4 kHz	for $0^\circ \leq \alpha \leq 2^\circ$
$-186.613 + 21.206 \log \alpha$	dB(W/m <sup>2</sup> ) in 4 kHz	for $2^\circ < \alpha \leq 15^\circ$
-161	dB(W/m <sup>2</sup> ) in 4 kHz	for $15^\circ < \alpha \leq 90^\circ$
<b>Upper S band, from 2310 – 2390 MHz</b>		
-180.0	dB(W/m <sup>2</sup> ) in 4 kHz	for $0^\circ \leq \alpha \leq 2^\circ$
$-187.5 + 23.66 \log \alpha$	dB(W/m <sup>2</sup> ) in 4 kHz	for $2^\circ < \alpha \leq 11.5^\circ$
-162	dB(W/m <sup>2</sup> ) in 4 kHz	for $11.5^\circ < \alpha \leq 90^\circ$
<b>Lower C band, from 4400 – 4940 MHz</b>		
-178.0	dB(W/m <sup>2</sup> ) in 4 kHz	for $0^\circ \leq \alpha \leq 1^\circ$
$-180.333 + 2.333 \alpha$	dB(W/m <sup>2</sup> ) in 4 kHz	for $1^\circ < \alpha \leq 4^\circ$
-171.0	dB(W/m <sup>2</sup> ) in 4 kHz	for $4^\circ < \alpha \leq 90^\circ$
<b>Middle C band, from 5091 – 5150 MHz</b>		
-178.0	dB(W/m <sup>2</sup> ) in 4 kHz	for $0^\circ \leq \alpha \leq 1^\circ$
$-180.0 + 2.0 \alpha$	dB(W/m <sup>2</sup> ) in 4 kHz	for $1^\circ < \alpha \leq 3^\circ$
-174.0	dB(W/m <sup>2</sup> ) in 4 kHz	for $3^\circ < \alpha \leq 90^\circ$
<b>Upper C band, from 5925 – 6700 MHz</b>		
-178.0	dB(W/m <sup>2</sup> ) in 4 kHz	for $0^\circ \leq \alpha \leq 1^\circ$

<sup>21</sup> International Telecommunication Union. “Protection criteria for telemetry systems in the aeronautical mobile service...” ITU-R Recommendation M.1459. May 2000. May be superseded by update. Retrieved 17 May 2021. Available at <https://www.itu.int/rec/R-REC-M.1459-0-200005-I/en>.

<b>Table 2-7. Interference Protection Criteria by Band and Angle of Arrival</b>		
$-181.6 + 3.6 \alpha$	dB(W/m <sup>2</sup> ) in 4 kHz	for $1^\circ < \alpha \leq 2^\circ$
-174.4	dB(W/m <sup>2</sup> ) in 4 kHz	for $2^\circ < \alpha \leq 90^\circ$

[Appendix 2-F](#) provides additional explanation and example calculations to aid in understanding the application of these IPCs for different interference scenarios.

## APPENDIX 2-A

### Frequency Considerations for Telemetry

#### A.1. Purpose

This appendix was prepared with the cooperation and assistance of the Range Commanders Council (RCC) Frequency Management Group. This appendix provides guidance to telemetry users for the most effective use of the telemetry bands. Coordination with the frequency managers of the applicable test ranges and operating areas is recommended before a specific frequency band is selected for a given application. Government users should coordinate with the appropriate Area Frequency Coordinator and commercial users should coordinate with the AFTRCC. A list of the points of contact can be found in the NTIA manual (NTIA 2015).

#### A.2. Scope

This appendix is to be used as a guide by users of telemetry frequencies at Department of Defense (DoD)-related test ranges and contractor facilities. The goal of frequency management is to encourage maximal use and minimal interference among telemetry users and between telemetry users and other users of the electromagnetic spectrum.

##### A.2.a. Definitions

The following terminology is used in this appendix.

**Allocation (of a Frequency Band).** Entry of a frequency band into the Table of Frequency Allocations<sup>22</sup> for use by one or more radio communication services or the radio astronomy service under specified conditions.

**Assignment (of a Radio Frequency or Radio Frequency Channel).** Authorization given by an administration for a radio station to use an RF or RF channel under specified conditions.

**Authorization.** Permission to use an RF or RF channel under specified conditions.

**Certification.** The Military Command, Control, Communications, and Computers Executive Board's (MC4EB) process of verifying that a proposed system complies with the appropriate rules, regulations, and technical standards.

**J/F 12 Number.** The identification number assigned to a system by the MC4EB after the Application for Equipment Frequency Allocation (DD Form 1494) is approved; for example, J/F 12/6309 (sometimes called the J-12 number).

**Resolution Bandwidth.** The  $-3$  dB bandwidth of the measurement device.

##### A.2.b. Modulation methods

###### A.2.b(1) Traditional Modulation Methods

The traditional modulation methods for aeronautical telemetry are FM and PM. The PCM/FM method has been the most popular telemetry modulation since around 1970. The RF

---

<sup>22</sup> The definitions of the radio services that can be operated within certain frequency bands contained in the radio regulations as agreed to by the member nations of the International Telecommunications Union. This table is maintained in the United States by the Federal Communications Commission and the NTIA.

signal is typically generated by filtering the baseband NRZ-L signal and then frequency modulating a VCO. The optimum peak deviation is 0.35 times the bit rate and a good choice for a premodulation filter is a multi-pole linear phase filter with bandwidth equal to 0.7 times the bit rate. Both FM and PM have a variety of desirable features but may not provide the required bandwidth efficiency, especially for higher bit rates.

#### A.2.b(2) Improved Bandwidth Efficiency

When better bandwidth efficiency is required, the standard modulation methods for digital signal transmission are SOQPSK-TG and ARTM CPM. These methods offer constant characteristics and is compatible with nonlinear amplifiers with minimal spectral regrowth and minimal degradation of detection efficiency. Modulation method SOQPSK-TG requires the use of the differential encoder described in [Appendix 2-B](#). All of these bandwidth-efficient modulation methods require the data to be randomized either with the IRIG randomizer or through encryption.

#### A.2.c. Other Notations

The following notations are used in this appendix. Other references may define these terms slightly differently.

- a. **B99%** - Bandwidth containing 99% of the total power.
- b. **B<sub>-25dBm</sub>** - Bandwidth containing all components larger than -25 dBm.
- c. **B<sub>-60dBc</sub>** - Bandwidth containing all components larger than the power level that is 60 dB below the unmodulated carrier power.
- d. **dBc** - Decibels relative to the power level of the unmodulated carrier.
- e. **f<sub>c</sub>** - Assigned center frequency.

### A.3. Authorization to Use a Telemetry System

All RF emitting devices must have approval to operate in the US&P via a frequency assignment unless granted an exemption by the national authority. The NTIA is the President's designated national authority and spectrum manager. The NTIA manages and controls the use of RF spectrum by federal agencies in US&P territory. Obtaining a frequency assignment involves the two-step process of obtaining an RF spectrum support certification of major RF systems design, followed by an operational frequency assignment to the RF system user. These steps are discussed below and further explained in RCC 120 Appendix A.<sup>23</sup>

#### A.3.a. RF Spectrum Support Certification

All major DoD RF systems used by federal agencies must be submitted to the NTIA, via the Interdepartment Radio Advisory Committee, for system review and spectrum support certification prior to committing funds for acquisition and procurement. During the system review process, compliance with applicable standards, allocation tables, rules, and regulations is checked. For DoD agencies and for support of DoD contracts, this is accomplished via the

---

<sup>23</sup> Range Commanders Council. "Application for Equipment Frequency Allocation for Aeronautical Mobile Telemetry Systems." In *Telemetry Systems Radio Frequency Handbook*, Appendix A. RCC 120-21. July 2021. May be superseded by update. Retrieved July 10 2021. Available at <https://www.trmc.osd.mil/wiki/x/iYu8Bg>.

submission of technical data describing the system that will operate in the RF spectrum to the MC4EB. Noncompliance with standards, tables, rules, or regulations can result in denial of support, limited support, or support on an unprotected non-priority basis. All DoD RF users must obtain frequency assignments for any RF system (even if not considered major). This assignment is accomplished by submission of frequency use proposals through the appropriate frequency management offices. Frequency assignments may not be granted for major systems that have not obtained spectrum support certification.

#### A.3.a(1) Frequency Allocation

Telemetry systems must normally operate within the frequency bands designated for their use in the Table of Frequency Allocations. With sufficient justification, use of other bands may at times be permitted, but the certification process is much more difficult. If certification is granted on a noninterference basis to incumbent users, the local frequency manager is often unable to grant assignments because of interference to incumbent users.

##### a. *Telemetry Bands*

Air and space-to-ground telemetering is allocated in the ultra-high frequency (UHF) bands 1435 to 1535, 2200 to 2290, and 2310 to 2390 MHz (commonly known as the lower L-band, the lower S-band, and the upper S-band) and in the super-high frequency (SHF) bands 4400 to 4940 and 5091 to 5150 MHz (commonly known as lower C-band and middle C-band). Other mobile bands, such as 1780-1850 MHz, can also be used at many test ranges. Since these other bands are not considered a standard telemetry band per this document, potential users must coordinate, in advance, with the individual range(s) and ensure use of this band can be supported at the subject range(s) and that their technical requirements will be met.

##### b. *Very High Frequency Telemetry*

The very-high frequency (VHF) band, 216-265 MHz, was used for telemetry operations in the past. Telemetry bands were moved to the UHF bands as of 1 January 1970 to prevent interference to critical government land mobile and military tactical communications. Telemetry operation in this band is strongly discouraged and is considered only on an exceptional case-by-case basis. Refer to the Table of Frequency Allocations within the NTIA Red Book.

#### A.3.a(2) Technical Standards

The MC4EB and the NTIA review proposed telemetry systems for compliance with applicable technical standards. For the UHF and SHF telemetry bands, the current revisions of the following standards are considered applicable:

- a. RCC Document IRIG 106, Telemetry Standards;
- b. MIL-STD-461;
- c. NTIA Manual of Regulations and Procedures for Federal Radio Frequency Management (also referred to as the NTIA Red Book).

Applications for certification are also thoroughly checked in many other ways, including necessary and occupied bandwidths, modulation characteristics, reasonableness of output power, correlation between output power and amplifier type, and antenna type and characteristics. The associated receiver normally must be specified or referenced. The characteristics of the receiver and transmit and receive antennas are also verified.

A.3.b. Frequency Authorization

Spectrum certification of a telemetry system verifies that the system meets the technical requirements for successful operation in the electromagnetic environment; however, a user is not permitted to radiate with the telemetry system before requesting and receiving a specific frequency assignment. The assignment process considers when, where, and how the user plans to radiate. Use of the assignments is tightly scheduled by and among the individual ranges to make the most efficient use of the limited telemetry RF spectrum and to ensure that one user does not interfere with other users.

**A.4. Frequency Usage Guidance**

Frequency usage is controlled by scheduling in the areas where the tests will be conducted. [Figure A-1](#) displays the modulated spectrum for the uncoded modulation methods of PCM/FM, SOQPSK-TG, and ARTM CPM. Also considered are the coded waveforms of SOQPSK-STC, SOQPSK-LDPC, and SOQPSK-STC/LDPC. The spectra for these coded waveforms are identical to uncoded SOQPSK except for the occupied bandwidth.

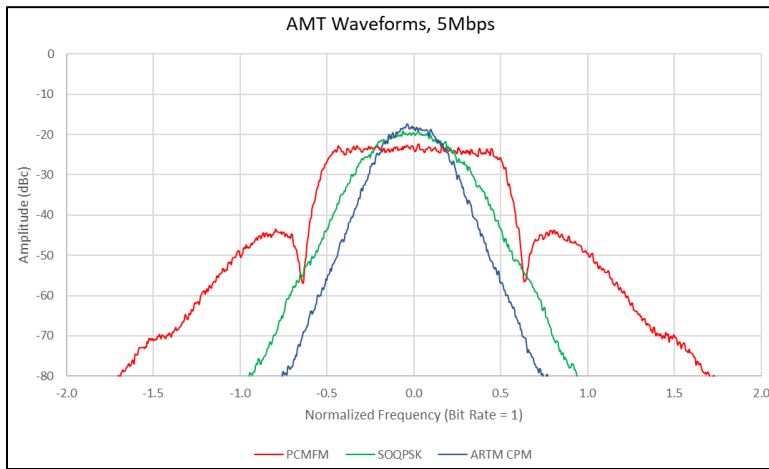

Figure A-1. Spectra of 5-Mbps PCM/FM, SOQPSK-TG, and ARTM CPM Signals

Coded waveforms increase the over-the-air bit rate and thus the transmitted bandwidth. This increase is due to the coding overhead added by each coding scheme. The following recommendations are based on extensive testing coupled with good engineering practice for scheduling spectrum usage. It is assumed that the occupied bandwidth of the waveforms fits within the telemetry band of interest in all cases.

A.4.a. Minimum Frequency Separation

The minimum required frequency separation can be calculated using Equation [A-1](#).

$$\Delta F_0 = a_s n_s R_s + a_i n_i R_i \tag{A-1}$$

where  $\Delta F_0$  = the minimum required center frequency separation in MHz;  
 $R_s$  = bit rate of desired signal in Mbps;  
 $R_i$  = bit rate of interfering signal in Mbps;  
 $a_s$  = spacing coefficient determined by the desired signal type;



$a_i$  = spacing coefficient determined by the interfering signal type and waveform characteristics;  
 $n_s$  = over-the-air bit rate multiplier for the desired signal;  
 $n_i$  = over-the-air bit rate multiplier for the interfering signal.

When neither signal is coded, use the spacing coefficients in [Table A-1](#). The over-the-air bit rate multiplier for the desired and interfering signals is 1 for uncoded waveforms.

<b>Table A-1. Coefficients for Minimum Frequency Separation Calculation for Uncoded Waveforms</b>		
Modulation Type	$a_s$	$a_i$
PCM/FM	0.80	0.95
SOQPSK-TG	0.60	0.45
ARTM CPM	0.55	0.30

When coded waveforms are the desired signal, the same equation (Equation [A-1](#)) for calculating the minimum frequency separation is used but with a different value of  $a_i$  depending upon the interfering signal per [Table A-2](#). This places the interfering signal closer to the coded desired signal. In addition, the appropriate over-the-air bit rate multiplier  $n_s$  and  $n_i$  for each signal should also be used per [Table A-3](#).

<b>Table A-2. Coefficients for Minimum Frequency Separation Calculation for Coded Waveforms</b>		
Modulation-Coding Type	$a_s$	$a_i$
PCM/FM		0.75
SOQPSK-TG		0.35
ARTM CPM		0.25
SOQPSK-STC	0.60	
SOQPSK-LDPC	0.60	
SOQPSK-STC/LDPC	0.60	

<b>Table A-3. Multipliers for Over-The-Air Bit Rate Calculation</b>	
Modulation-Coding Type	Multiplier $n_s, n_i$
PCM/FM, SOQPSK-TG, ARTM CPM	1
SOQPSK-STC	26/25
SOQPSK-LDPC Code Rate $r = 4/5$	21/16
SOQPSK-LDPC Code Rate $r = 2/3$	25/16
SOQPSK-LDPC Code Rate $r = 1/2$	33/16
SOQPSK-STC/LDPC $r = 4/5$	273/200
SOQPSK-STC/LDPC $r = 2/3$	13/8
SOQPSK-STC/LDPC $r = 1/2$	429/200

The minimum spacing needs to be calculated for the desired signal and the interferer and vice versa. The spacing factors have subscripts of *s* for signal and *i* for interferer. The required frequency spacing from the interferer,  $a_i$ , is directly related to the power spectrum of the interfering signal. The values for  $a_s$  are a function of the effective detection filter bandwidths, the adjacent channel interference resistance of the desired signal modulation and coding method, and the type of detector employed within the receiver. The values for  $a_s$  and  $a_i$  are slightly conservative for most cases and assume the receiver being used does not have spurious responses that cause additional interference. The main assumptions are as follows:

- a. The NRZ PCM/FM signals are assumed to be premodulation filtered with a multi-pole Bessel filter with  $-3$  dB point of exactly 0.7 times the bit rate and the peak deviation of exactly 0.35 times the bit rate. The modulation index  $h = 0.7$ .
- b. With the stipulation given in a., a multi-symbol detector is assumed for NRZ PCM/FM.
- c. The receiver IF filter is assumed to be no narrower than 1.5 times the bit rate and no wider than 2 times the bit rate and provides at least 6 dB of attenuation of the interfering signal.
- d. The interfering signal is assumed to be no more than 20 dB stronger than the desired signal. resulting in a carrier-to-interferer ratio  $C/I \leq -20$  dB.
- e. The receiver is assumed to be operating in linear mode and not in saturation; no significant intermodulation products or spurious responses are present.

The following examples are grouped into two categories that correspond to [Table A-1](#), [Table A-2](#), and [Table A-3](#). The first category is for calculating the required spacing when only uncoded waveforms are being scheduled. For these waveforms the bit rate multiplier is 1; therefore, the bit rate equals the over-the-air bit rate. The second category is for calculating the required spacing when there are both uncoded and coded waveforms being scheduled. In each example the desired and interfering signals are swapped for the spacing calculation with the larger resulting spacing being chosen. The reason for this is that both signals are desired, just by different users.

#### Uncoded Waveform Examples

1. Desired Signal: 5 Mbps PCM/FM; Interfering Signal: 3 Mbps SOQPSK-TG

Desired Signal: 3 Mbps SOQPSK-TG; Interfering Signal: 5 Mbps PCM/FM

$$0.85 * 1 * 5 + 0.45 * 1 * 3 = 5.6 \text{ MHz}$$

$$0.60 * 1 * 3 + 0.95 * 1 * 5 = 6.6 \text{ MHz}$$

The larger value is 6.6 MHz; center frequencies are assigned in 1 MHz steps so the minimum spacing is 7 MHz. An example of this minimum frequency spacing is shown in [Figure A-2](#).

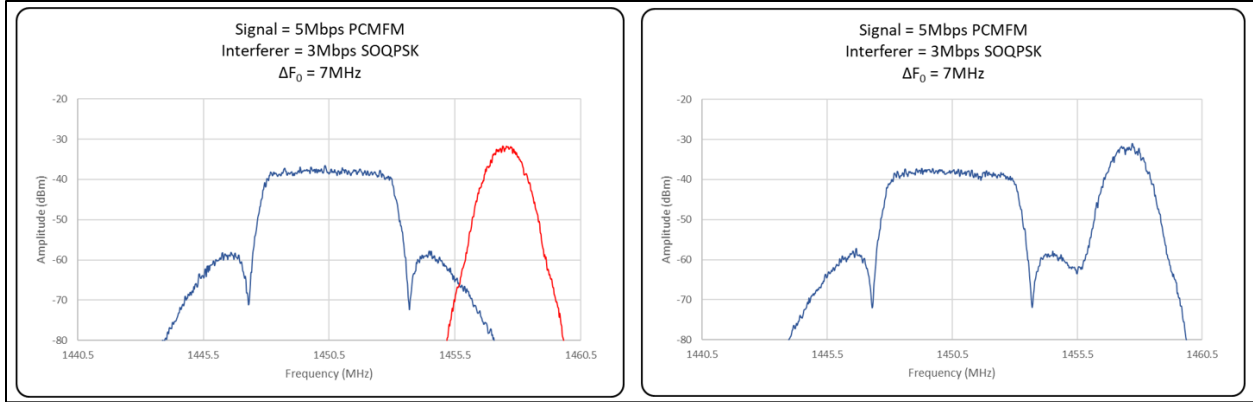

Figure A-2. Center Frequency Spacing 5 Mbps PCM/FM and 3 Mbps SOQPSK-TG

2. Desired Signal: 12.5 Mbps SOQPSK-TG; Interfering Signal: 6 Mbps ARTM CPM  
Desired Signal: 6 Mbps ARTM CPM; Interfering Signal: 12.5 Mbps SOQPSK-TG

$$0.60 \cdot 1 \cdot 12.5 + 0.30 \cdot 1 \cdot 6 = 9.3 \text{ MHz}$$

$$0.55 \cdot 1 \cdot 6 + 0.45 \cdot 1 \cdot 12.5 = 8.9 \text{ MHz}$$

The larger value is 9.3 MHz; center frequencies are assigned in 1 MHz steps so the minimum spacing is 10 MHz. An example of this minimum frequency spacing is shown in [Figure A-3](#).

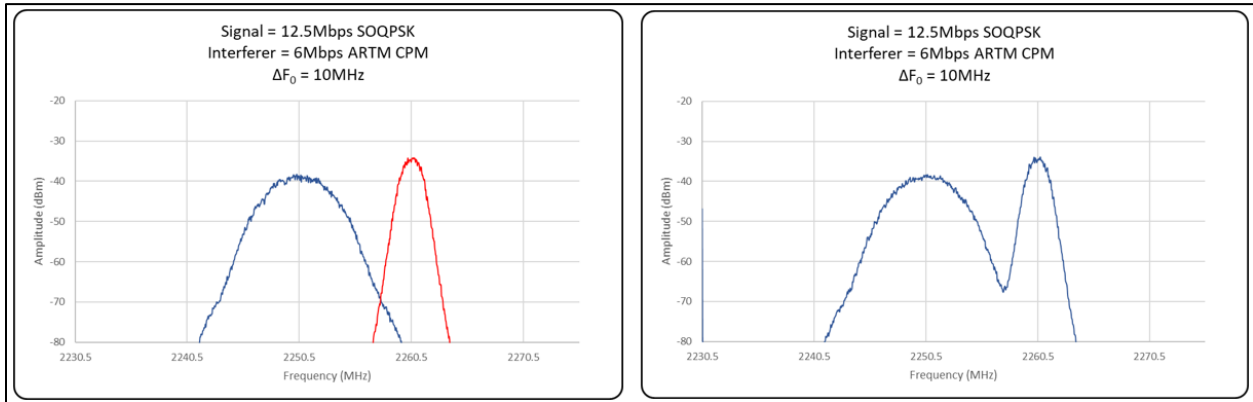

Figure A-3. Center Frequency Spacing 12.5 Mbps PCM/FM and 6 Mbps ARTM CPM

3. Desired Signal: 4.3 Mbps SOQPSK-TG; Interfering Signal: 7.25 Mbps SOQPSK-TG  
Desired Signal: 7.25 Mbps SOQPSK-TG; Interfering Signal: 4.3 Mbps SOQPSK-TG

$$0.60 \cdot 1 \cdot 4.3 + 0.45 \cdot 1 \cdot 7.25 = 5.8 \text{ MHz}$$

$$0.60 \cdot 1 \cdot 7.25 + 0.45 \cdot 1 \cdot 4.3 = 6.3 \text{ MHz}$$

The larger value is 6.3 MHz; center frequencies are assigned in 1 MHz steps, so the minimum spacing is 7 MHz. An example of this minimum frequency spacing is shown in [Figure A-4](#).

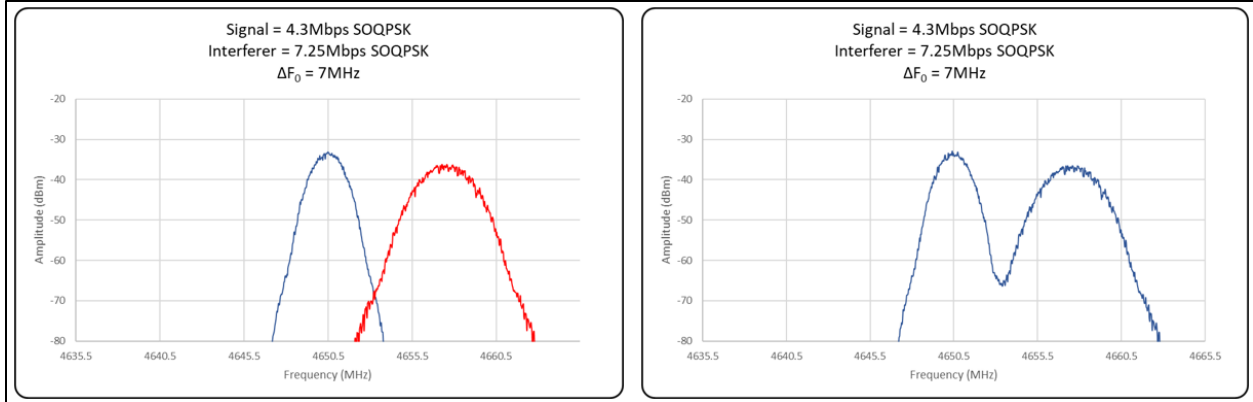

Figure A-4. Center Frequency Spacing 4.3 Mbps SOQPSK-TG and 7.25 Mbps SOQPSK-TG

*Coded Waveform Examples*

When calculating the minimum frequency separation using the spacing coefficients in [Table A-2](#), note that the interfering signal can be placed closer in frequency when the desired signal is coded. This is reflected in the spacing factor  $a_i$  for the interfering signal decreasing in value when compared to the uncoded case ([Table A-1](#)). The bit rate  $r$  used in these calculations is the over-the-air bit rate after coding is applied. [Table A-3](#) gives the multipliers used in determining the over-the-air bit rate for each possible combination of modulation and coding scheme.

1. Desired Signal: 8 Mbps SOQPSK-LDPC ( $r=4/5$ ,  $k=1024$ ); Interfering Signal: 4.2 Mbps PCM/FM

Desired Signal: 4.2 Mbps PCM/FM; Interfering Signal: 8 Mbps SOQPSK-LDPC ( $r=4/5$ ,  $k=1024$ )

$$0.60 \cdot (21/16) \cdot 8 + 0.75 \cdot 1 \cdot 4.2 = 9.45 \text{ MHz} \quad 0.80 \cdot 1 \cdot 4.2 + 0.45 \cdot (21/16) \cdot 8 = 8.09 \text{ MHz}^1$$

The largest value is 9.45 MHz; frequencies are assigned in 1 MHz steps so the minimum spacing is 10 MHz. [1] In this calculation, the spacing coefficient of 0.45 for SOQPSK-TG in [Table A-1](#) should be used for the coded interfering signal as the desired signal is uncoded. An example of this minimum frequency spacing is shown in [Figure A-5](#).

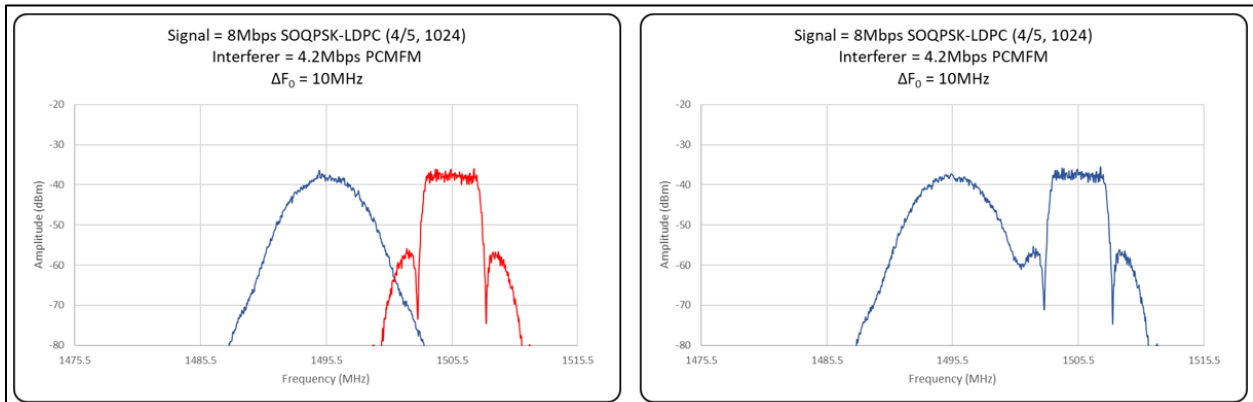

Figure A-5. Center Frequency Spacing 8 Mbps SOQPSK-LDPC and 4.2 Mbps PCM/FM

2. Desired Signal: 3.6 Mbps SOQPSK-LDPC ( $r=1/2$ ,  $k=4096$ ); Interfering Signal: 12 Mbps SOQPSK-TG  
Desired Signal: 12 Mbps SOQPSK-TG; Interfering Signal: 3.6 Mbps SOQPSK-LDPC ( $r=1/2$ ,  $k=4096$ )

$$0.60 \cdot (33/16) \cdot 3.6 + 0.35 \cdot 1 \cdot 12 = 8.655 \text{ MHz} \quad 0.60 \cdot 1 \cdot 12 + 0.45 \cdot (33/16) \cdot 3.6 = 10.54 \text{ MHz}^1$$

The largest value is 10.54 MHz; frequencies are assigned in 1 MHz steps so the minimum spacing is 11 MHz. [1] In this calculation, the spacing coefficient of 0.45 for SOQPSK-TG in [Table A-1](#) should be used for the coded interfering signal as the desired signal is uncoded. An example of this minimum frequency spacing is shown in [Figure A-6](#).

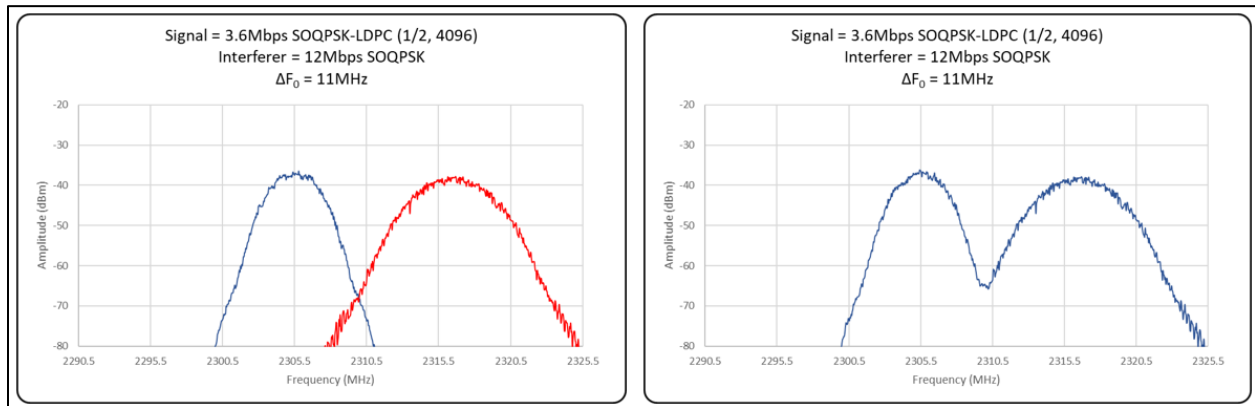

Figure A-6. Center Frequency Spacing 3.6 Mbps SOQPSK-LDPC and 12 Mbps SOQPSK-TG

3. Desired Signal: 8 Mbps SOQPSK-STC; Interfering Signal: 2 Mbps PCM/FM  
Desired Signal: 2 Mbps PCM/FM; Interfering Signal: 8 Mbps SOQPSK-STC

$$0.60 \cdot (26/25) \cdot 8 + 0.75 \cdot 1 \cdot 2 = 6.49 \text{ MHz} \quad 0.80 \cdot 1 \cdot 2 + 0.45 \cdot (26/25) \cdot 8 = 5.34 \text{ MHz}^1$$

The largest value is 6.49 MHz; frequencies are assigned in 1 MHz steps so the minimum spacing is 7 MHz. [1] In this calculation, the spacing coefficient of 0.45 for SOQPSK-TG in [Table A-1](#) should be used for the coded interfering signal as the desired signal is uncoded. An example of this minimum frequency spacing is shown in [Figure A-7](#).

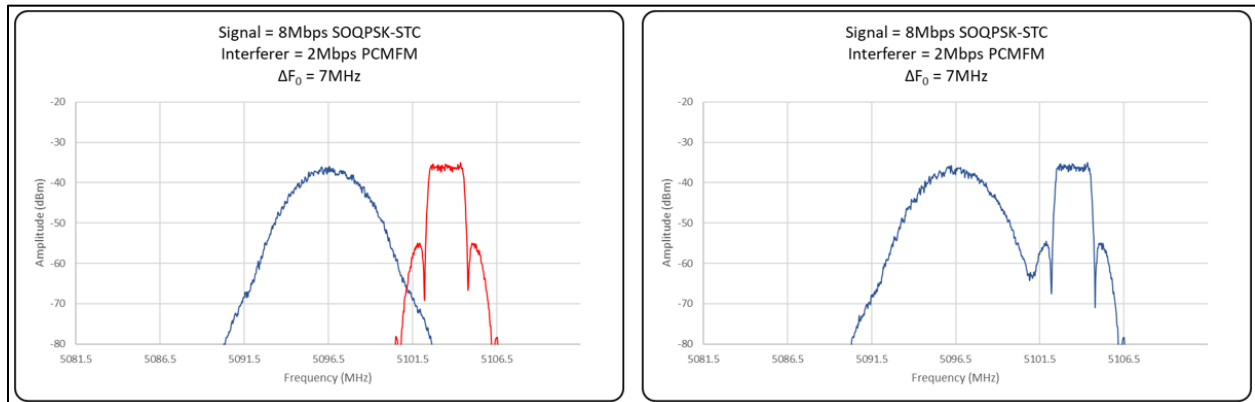

Figure A-7. Center Frequency Spacing 8 Mbps SOQPSK-STC and 2 Mbps PCM/FM

4. Desired Signal: 5.8 Mbps SOQPSK-STC/LDPC ( $r=2/3, k=1024$ ); Interfering Signal: 6.95 Mbps SOQPSK-LDPC ( $r=4/5, k=4096$ )

Desired Signal: 6.95 Mbps SOQPSK-LDPC ( $r=4/5, k=4096$ ); Interfering Signal: 5.8 Mbps SOQPSK-STC/LDPC ( $r=2/3, k=1024$ )

$$0.60 \cdot (13/8) \cdot 5.8 + 0.35 \cdot (21/16) \cdot 6.95 = 8.85 \text{ MHz}^1$$

$$0.60 \cdot (21/16) \cdot 6.95 + 0.35 \cdot (13/8) \cdot 5.8 = 8.77 \text{ MHz}^1$$

The largest value is 8.85 MHz; frequencies are assigned in 1 MHz steps so the minimum spacing is 9 MHz. [1] In both of these calculations the spacing coefficient of 0.35 for SOQPSK-TG in [Table A-2](#) should be used for the coded interfering signal as the desired signal is also coded. An example of this minimum frequency spacing is shown in [Figure A-8](#).

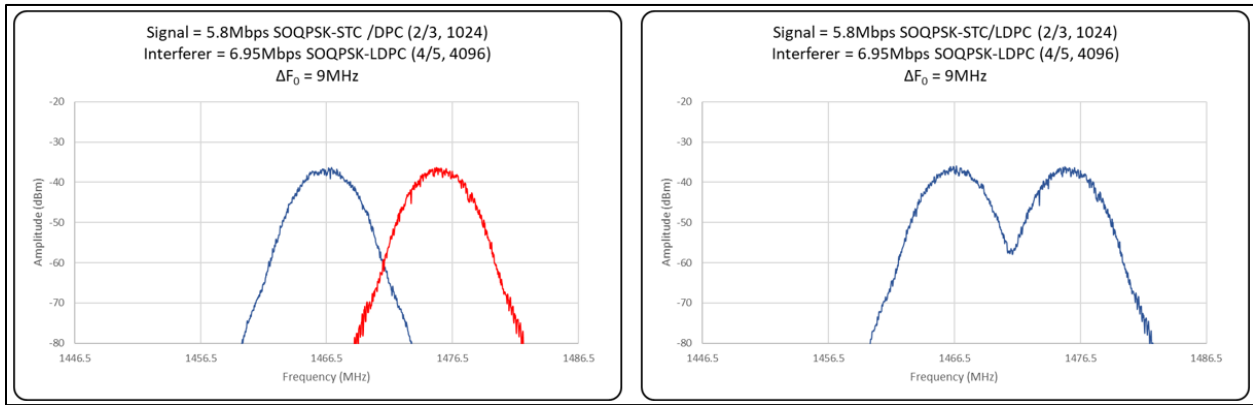

Figure A-8. Center Frequency Spacing 5.8 Mbps SOQPSK-STC/LDPC and 6.95 Mbps SOQPSK-LDPC

5. Desired Signal: 11 Mbps SOQPSK; Interfering Signal: 2.7 Mbps SOQPSK-LDPC ( $r=4/5, k=1024$ )

Desired Signal: 2.7 Mbps SOQPSK-LDPC ( $r=4/5, k=1024$ ); Interfering Signal: 11 Mbps SOQPSK

$$0.60 \cdot (1) \cdot 11 + 0.45 \cdot (21/16) \cdot 2.7 = 8.19 \text{ MHz} \quad 0.60 \cdot (21/16) \cdot 2.7 + 0.35 \cdot (1) \cdot 11 = 5.98 \text{ MHz}^1$$

The largest value is 8.19 MHz; frequencies are assigned in 1 MHz steps so the minimum spacing is 9 MHz. [1] In this calculation the spacing coefficient of 0.35 for SOQPSK-TG in [Table A-2](#) should be used for the uncoded interfering signal as the desired signal is coded. An example of this minimum frequency spacing is shown in [Figure A-9](#).

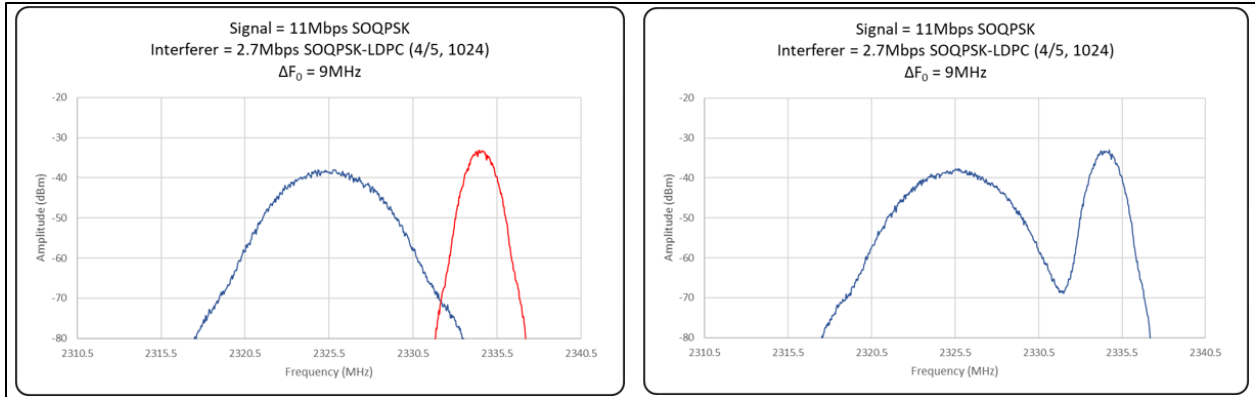

Figure A-9. Center Frequency Spacing 11 Mbps SOQPSK and 2.7 Mbps SOQPSK-LDPC

6. Desired Signal: 5 Mbps SOQPSK-STC; Interfering Signal: 5 Mbps SOQPSK-STC

$$0.60*(26/25)*5 + 0.35*(26/25)*5 = 4.94 \text{ MHz}^1$$

Only one calculation was done as both signals are identical, resulting a value of 4.94 MHz; frequencies are assigned in 1 MHz steps so the minimum spacing is 5 MHz. [1] In this calculation, the spacing coefficient of 0.35 for SOQPSK-TG in [Table A-2](#) should be used for the coded interfering signal as the desired signal is also coded. An example of this minimum frequency spacing is shown in [Figure A-10](#).

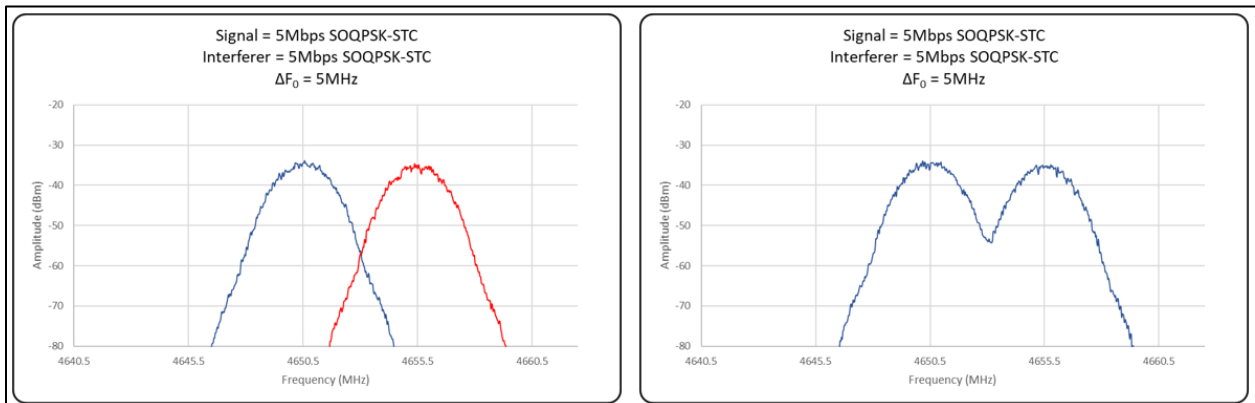

Figure A-10. Center Frequency Spacing 5 Mbps SOQPSK-STC and 5 Mbps SOQPSK-STC

In some cases it may be desirable to set aside a bandwidth for each signal independent of other signals based solely on modulation scheme and over-the-air bit rate. Typical values for spacing factors for this type of frequency spacing are 2.5 for PCM/FM, 1.5 for SOQPSK, and 1.3 for ARTM CPM. One problem with this approach is that it does not include receiver or detector characteristics or coding and therefore the calculated frequency separations are often much wider than those calculated using [Equation A-1](#).

Several examples of this type of frequency separation calculation are shown below.

1. Desired Signal: 5 Mbps PCM/FM; Interfering Signal: 3 Mbps SOQPSK  
 $[2.5*(1)*5 + 1.5*(1)*3]/2 = 8.5 \text{ MHz}$

In order to arrive at the center-to-center spacing, the total calculated bandwidth must be divided by a factor of 2. The frequencies are assigned in 1 MHz steps, so the minimum spacing is 9 MHz. Compare this value to 7 MHz using Equation [A-1](#) and it becomes evident this type of calculation is pessimistic.

2. Desired Signal: 5.8 Mbps SOQPSK-STC/LDPC ( $r=2/3$ ,  $k=1024$ ); Interfering Signal: 6.95 Mbps SOQPSK-LDPC ( $r=4/5$ ,  $k=4096$ )

$$[1.5*(13/8)*5.8 + 1.5*(21/16)*6.95]/2 = 13.9 \text{ MHz}$$

The frequencies are assigned in 1 MHz steps, so the minimum spacing is 14 MHz. Compare this to 9 MHz when using Equation [A-1](#).

3. Desired Signal: 5 Mbps SOQPSK-STC; Interfering Signal: 5 Mbps SOQPSK-STC

$$[1.5*(26/25)*5 + 1.5*(26/25)*5]/2 = 7.8 \text{ MHz}$$

The frequencies are assigned in 1 MHz steps, so the minimum spacing is 8 MHz. Compare this to 5 MHz when using Equation [A-1](#).

#### A.4.b. Geographical Separation

Geographical separation can be used to further reduce the probability of interference from adjacent signals.

#### A.4.c. Multicarrier Operation

If two transmitters are operated simultaneously and sent or received through the same antenna system, interference due to intermodulation is likely at frequencies of  $(2f_1 - f_2)$  and  $(2f_2 - f_1)$ . Between three transmitters, the two-frequency possibilities still exist, but intermodulation products may exist as well at  $(f_1 + f_2 - f_3)$ ,  $(f_1 + f_3 - f_2)$ , and  $(f_2 + f_3 - f_1)$ , where  $f_1$ ,  $f_2$ , and  $f_3$  represent the output frequencies of the transmitters. Intermodulation products can arise from nonlinearities in the transmitter output circuitry that cause mixing products between a transmitter output signal and the fundamental signal coming from nearby transmitters. Intermodulation products also can arise from nonlinearities in the antenna systems. The generation of intermodulation products is inevitable, but the effects are generally of concern only when such products exceed  $-25$  dBm. The general rule for avoiding third-order intermodulation interference is that in any group of transmitter frequencies, the separation between any pair of frequencies should not be equal to the separation between any other pair of frequencies. Because individual signals have sidebands, it should be noted that intermodulation products have sidebands spectrally wider than the sidebands of the individual signals that caused them.

#### A.4.d. Transmitter Antenna System Emission Testing

Radiated tests will be made in lieu of transmitter output tests only when the transmitter is inaccessible. Radiated tests may still be required if the antenna is intended to be part of the filtering of spurious products from the transmitter or is suspected of generating spurious products by itself or in interaction with the transmitter and feed lines. These tests should be made with modulation enabled.

### A.5. **Bandwidth**

The definitions of bandwidth in this section are universally applicable. The limits shown here are applicable for telemetry operations in the telemetry bands specified in [Chapter 2](#). For the



purposes of telemetry signal spectral occupancy, the bandwidths used are B99% and B<sub>-25dBm</sub>. A power level of -25 dBm is exactly equivalent to an attenuation of the transmitter power by 55 + 10×log(P) dB where P is the transmitter power expressed in watts. How bandwidth is actually measured and what the limits are, expressed in terms of that measuring system, are detailed in the following paragraphs.

A.5.a. Concept

The term “bandwidth” has an exact meaning in situations where an AM, double-sideband, or single-sideband signal is produced with a band-limited modulating signal. In systems employing FM or PM, or any modulation system where the modulating signal is not band limited, bandwidth is infinite with energy extending toward zero and infinite frequency falling off from the peak value in some exponential fashion. In this more general case, bandwidth is defined as the band of frequencies in which most of the signal’s energy is contained. The definition of “most” is imprecise. The following terms are applied to bandwidth.

A.5.a(1) Authorized Bandwidth

For purposes of this document, the authorized bandwidth is the necessary bandwidth required for transmission and reception of intelligence and does not include allowance for transmitter drift or Doppler shift.

A.5.a(2) Occupied Bandwidth

The width of a frequency band such that below the lower and above the upper frequency limits, the mean powers emitted are each equal to a specified percentage of the total mean power of a given emission. Unless otherwise specified by the ITU for the appropriate class of emission, the specified percentage shall be 0.5%. In this document occupied bandwidth and B99% are interchangeable.

A.5.a(3) Necessary Bandwidth for a Given Class of Emission

For a given class of emission, the width of the frequency band that is just sufficient to ensure the transmission of information at the rate and with the quality required under specified conditions. Note: the term “under specified conditions” does not include signal bandwidth required when operating with adjacent channel signals (i.e., potential interferers).

a. *The NTIA Manual*

This manual states that “All reasonable effort shall be made in equipment design and operation by Government agencies to maintain the occupied bandwidth of the emission of any authorized transmission as closely to the necessary bandwidth as is reasonably practicable.”

b. *Necessary Bandwidth (DD Form 1494)*

The necessary bandwidth is part of the emission designator on the DD Form 1494. For telemetry purposes, the necessary bandwidth can be calculated using the equations shown in [Table A-4](#). Equations for these and other modulation methods are contained in Annex J of the NTIA Manual.

<b>Table A-4. B99% for Various Digital Modulation Methods</b>	
<b>Description</b>	<b>B99%</b>
NRZ PCM/FM, premod filter BW=0.7R, Δf=0.35R	1.16 R
NRZ PCM/FM, no premod filter, Δf=0.25R	1.18 R

NRZ PCM/FM, no premod filter, $\Delta f=0.35R$	1.78 R
NRZ PCM/FM, no premod filter, $\Delta f=0.40R$	1.93 R
NRZ PCM/FM, premod filter $BW=0.7R$ , $\Delta f=0.40R$	1.57 R
Minimum shift keying (MSK), no filter	1.18 R
SOQPSK-TG	0.78 R
ARTM CPM	0.56 R

**Filtered NRZ PCM/FM.**  $B_n = 1.16 \cdot \text{bit rate}$  with  $h=0.7$  and premodulation filter bandwidth = 0.7 times bit rate. Example: PCM/FM modulation used to send 5 Mbps using PCM/FM with 2 signaling states and 1.75 MHz peak deviation; bit rate= $5 \cdot 10^6$ ; necessary bandwidth ( $B_n$ ) = 5.8 MHz.

**SOQPSK-TG.**  $B_n = 0.78 \cdot \text{bit rate}$ . Example: SOPQSK-TG modulation used to send 5 Mbps using 4 signaling states; bit rate= $5 \cdot 10^6$ ;  $B_n = 3.9$  MHz.

**ARTM CPM.**  $B_n = 0.56 \cdot \text{bit rate}$  with  $h=4/16$  and  $5/16$  on alternating symbols; digital modulation used to send 5 Mbps using FM with 4 signaling states and with alternating modulation index each symbol; bit rate= $5 \cdot 10^6$ ;  $B_n = 2.8$  MHz.

#### A.5.a(4) Received (or Receiver) Bandwidth

The received bandwidth is usually the  $-3$  dB bandwidth of the receiver IF section.

#### A.5.b. Bandwidth Estimation and Measurement

Various methods are used to estimate or measure the bandwidth of a signal that is not band limited. The bandwidth measurements are performed using a spectrum analyzer (or equivalent device) with the following settings: 30-kHz resolution bandwidth, 300-Hz video bandwidth, and no max hold detector or averaging. These settings are different than those in earlier versions of the Telemetry Standards. The settings were changed to get more consistent results across a variety of bit rates, modulation methods, and spectrum analyzers. The most common measurement and estimation methods are described in the following paragraphs.

##### A.5.b(1) B99%

This bandwidth contains 99% of the total power. Typically, B99% is measured using a spectrum analyzer or estimated using equations for the modulation type and bit rate used. If the two points that define the edges of the band are not symmetrical about the assigned center frequency, their actual frequencies and difference should be noted. The B99% edges of randomized NRZ (RNRZ) PCM/FM signals are shown in [Figure A-11](#). [Table A-4](#) presents B99% for several digital modulation methods as a function of the bit rate (R).

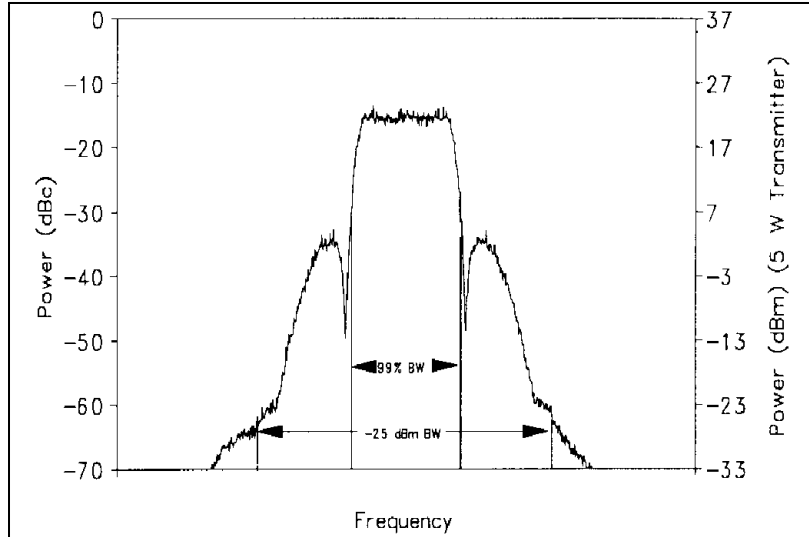

Figure A-11. RNRZ PCM/FM Signal

#### A.5.b(2) $B_{-25\text{dBm}}$

$B_{-25\text{dBm}}$  is the bandwidth containing all components larger than  $-25\text{ dBm}$ . A power level of  $-25\text{ dBm}$  is exactly equivalent to an attenuation of the transmitter power by  $55 + 10 \times \log(P)$  dB where  $P$  is the transmitter power expressed in watts.  $B_{-25\text{dBm}}$  limits are shown in [Figure A-11](#).  $B_{-25\text{dBm}}$  is primarily a function of the modulation method, transmitter power, and bit rate. The transmitter design and construction techniques also strongly influence  $B_{-25\text{dBm}}$ . With a bit rate of 5 Mbps and a transmitter power of 5 watts, the  $B_{-25\text{dBm}}$  of an NRZ PCM/FM system with near optimum parameter settings is about 13.3 MHz, while  $B_{-25\text{dBm}}$  of an equivalent SOQPSK-TG system is about 7.5 MHz, and  $B_{-25\text{dBm}}$  of an equivalent ARTM CPM system is about 5.8 MHz.

#### A.5.b(3) Scheduled Bandwidth

This bandwidth should be used by organizations responsible for either requesting or scheduling bandwidth required for telemetry signals. These signals are either packed tightly within existing telemetry bands, operating without adjacent signals, or are scheduled near telemetry band edges. Scheduled bandwidth should be calculated for these three cases in the following manner.

- If the telemetry signal will be operating in the absence of adjacent signals, use the  $B_{99\%}$  (occupied bandwidth) calculations in [Table A-4](#) to determine scheduled bandwidth.
- If the telemetry signal will be operating in the presence of adjacent telemetry signals, use the minimum frequency separation calculations in [Table A-1](#) to determine scheduled bandwidth.
- If the telemetry signal will be operating near a telemetry band edge, use the calculations in [Section A.11](#) to determine proper spacing from the band edge.

### A.5.c. Other Bandwidth Measurement Methods

The methods discussed above are the standard methods for measuring the bandwidth of telemetry signals. The following methods are also sometimes used to measure or to estimate the bandwidth of telemetry signals.

#### A.5.c(1) Below Unmodulated Carrier

This method measures the power spectrum with respect to the unmodulated carrier power. To calibrate the measured spectrum on a spectrum analyzer, the unmodulated carrier power must be known. This power level is the 0-dB reference (commonly set to the top of the display). In AM systems, the carrier power never changes; in FM and PM systems, the carrier power is a function of the modulating signal. Therefore, a method to estimate the unmodulated carrier power is required if the modulation cannot be turned off. For most practical angle modulated systems, the total carrier power at the spectrum analyzer input can be found by setting the spectrum analyzer's resolution and video bandwidths to their widest settings, setting the analyzer output to max hold, and allowing the analyzer to make several sweeps. The maximum value of this trace will be a good approximation of the unmodulated carrier level. [Figure A-12](#) shows the spectrum of a 5-Mbps RNRZ PCM/FM signal measured using the standard spectrum analyzer settings discussed previously and the spectrum measured using 3-MHz resolution, video bandwidths, and max hold.

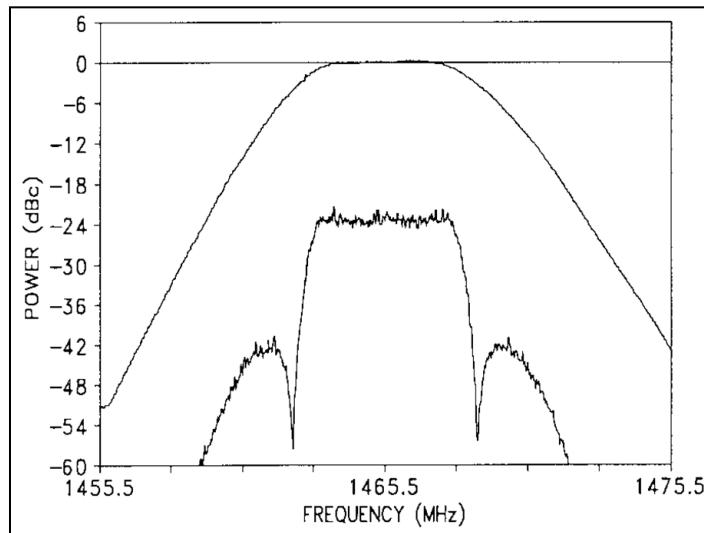

Figure A-12. Spectrum Analyzer Calibration of 0-dBc Level

The peak of the spectrum measured with the latter conditions is very close to 0-dBc and can be used to estimate the unmodulated carrier power (0-dBc) in the presence of FM or PM. In practice, the 0-dBc calibration would be performed first, and the display settings would then be adjusted to use the peak of the curve as the reference level (0-dBc level) to calibrate the spectrum measured using the standard spectrum analyzer settings. With the spectrum analyzer set for a specific resolution bandwidth, video bandwidth, and detector type, the bandwidth is taken as the distance between the two points outside of which the spectrum is thereafter some number (say, 60 dB) below the unmodulated carrier power determined above.  $B_{-60\text{dBc}}$  for the 5-Mbps signal shown in [Figure A-12](#) is approximately 13 MHz.

$B_{-60\text{dBc}}$  of an RNRZ PCM/FM signal with a peak deviation of  $0.35R$ , a four-pole premodulation filter with  $-3$  dB corner at  $0.7R$ , and a bit rate greater than or equal to 1 Mbps can be approximated by the following equation:

$$B_{-60\text{dBc}} = [2.78 - 0.3 * \log_{10}(R)] * R \quad \text{A-2}$$

where  $B$  is in MHz;  
 $R$  is in Mbps.

Thus  $B_{-60\text{dBc}}$  of a 5-Mbps RNRZ signal under these conditions would be approximately 12.85 MHz.  $B_{-60\text{dBc}}$  will be greater if peak deviation is increased or the number of filter poles is decreased.

#### A.5.c(2) Below Peak

This method is not recommended for measuring the bandwidth of telemetry signals. The modulated peak method, the least accurate measurement method, measures between points where the spectrum is thereafter XX dB below the level of the highest point on the modulated spectrum. [Figure A-13](#) shows the RF spectrum of a 400-kbps bi-phase (Bi $\phi$ )-level PCM/PM signal with a peak deviation of  $75^\circ$  and a pre-modulation filter bandwidth of 800 kHz.

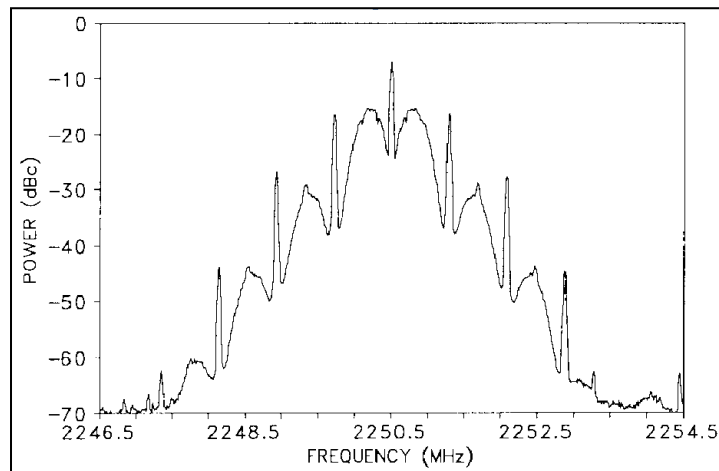

Figure A-13. Bi $\phi$  PCM/PM Signal

The largest peak has a power level of  $-7$  dBc. In comparison, the largest peak in [Figure A-13](#) had a power level of  $-22$  dBc. This 15-dB difference would skew a bandwidth comparison that used the peak level in the measured spectrum as a common reference point. In the absence of an unmodulated carrier to use for calibration, the below-peak measurement is often (erroneously) used and described as a below-unmodulated-carrier measurement. Using max hold exacerbates this effect still further. In all instances the bandwidth is overstated, but the amount varies.

#### A.5.c(3) Carson's Rule

Carson's Rule is a method to estimate the bandwidth of an FM subcarrier system. Carson's Rule states the following:

$$B = 2(\Delta f + f_{\text{max}}) \quad \text{A-3}$$

where  $B$  is the bandwidth;  
 $\Delta f$  is the peak deviation of the carrier frequency;

$f_{\max}$  is the highest frequency in the modulating signal.

Figure A-14 shows the spectrum that results when a 12-channel constant bandwidth multiplex with 6-dB/octave pre-emphasis frequency modulates an FM transmitter. B99% and the bandwidth calculated using Carson's Rule are also shown. Carson's Rule will estimate a value greater than B99% if little of the carrier deviation is due to high-frequency energy in the modulating signal.

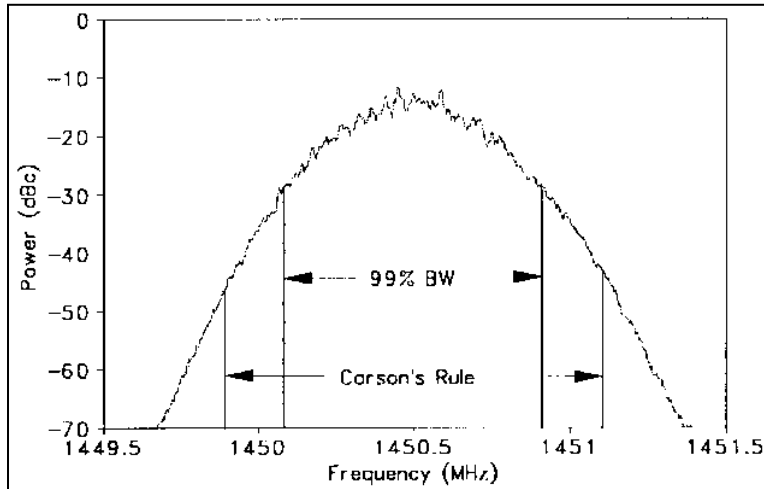

Figure A-14. FM/AM Signal and Carson's Rule

#### A.5.d. Spectral Equations

The following equations can be used to calculate the RF spectra for several digital modulation methods with unfiltered waveforms.<sup>24, 25, 26</sup> These equations can be modified to include the effects of filtering.<sup>27, 28</sup>

RNRZ PCM/FM (valid when  $D \neq \text{integer}$ ,  $D = 0.5$  gives MSK spectrum)

$$S(f) = \frac{4 B_{SA}}{R} \left( \frac{D}{\pi(D^2 - X^2)} \right)^2 \frac{(\cos \pi D - \cos \pi X)^2}{1 - 2 \cos \pi D \cos \pi X + \cos^2 \pi D}, \quad \cos \pi D < Q \quad \text{A-4}$$

<sup>24</sup> I. Korn. *Digital Communications*, New York, Van Nostrand, 1985.

<sup>25</sup> M. G. Pelchat. "The Autocorrelation Function and Power Spectrum of PCM/FM with Random Binary Modulating Waveforms," *IEEE Transactions*, Vol. SET-10, No. 1, pp. 39-44, March 1964.

<sup>26</sup> Tey, W. M. and T. Tjhung. "Characteristics of Manchester-Coded FSK," *IEEE Transactions on Communications*, Vol. COM-27, pp. 209-216, January 1979.

<sup>27</sup> Watt, A. D., V. J. Zurick, and R. M. Coon. "Reduction of Adjacent-Channel Interference Components from Frequency-Shift-Keyed Carriers," *IRE Transactions on Communication Systems*, Vol. CS-6, pp. 39-47, December 1958.

<sup>28</sup> E. L. Law. "RF Spectral Characteristics of Random PCM/FM and PSK Signals," *International Telemetry Conference Proceedings*, pp. 71-80, 1991.

## RNRZ PSK

$$S(f) = \frac{B_{SA}}{R} \frac{\sin^2\left(\frac{\pi X}{2}\right)}{\left(\frac{\pi X}{2}\right)^2} \quad \text{A-5}$$

## RNRZ QPSK and OQPSK

$$S(f) = \frac{2B_{SA}}{R} \frac{\sin^2(\pi X)}{(\pi X)^2} \quad \text{A-6}$$

## Random Biφ PCM/FM

$$S(f) = \frac{B_{SA}}{4R} \left( \frac{\pi D}{2} \frac{\sin\left(\frac{\pi(X-D)}{4}\right)}{\frac{\pi(X-D)}{4}} \frac{\sin\left(\frac{\pi(X+D)}{4}\right)}{\frac{\pi(X+D)}{4}} \right)^2 + \left( \frac{D \sin\left(\frac{\pi D}{2}\right)}{\pi(X^2 - D^2)} \right)^2 \delta\{(f - f_c) - nR\} \quad \text{A-7}$$

## Random Biφ PCM/PM

$$S(f) = \frac{B_{SA} \sin^2(\beta)}{R} \frac{\sin^4\left(\frac{\pi X}{4}\right)}{\left(\frac{\pi X}{4}\right)^2} + \cos^2(\beta) \delta(f - f_c), \quad \beta \leq \frac{\pi}{2} \quad \text{A-8}$$

- where
- $S(f)$  = power spectrum (dBc) at frequency  $f$
  - $B_{SA}$  = spectrum analyzer resolution bandwidth\*
  - $R$  = bit rate
  - $D = 2\Delta f/R$
  - $X = 2(f-f_c)/R$
  - $\Delta f$  = peak deviation
  - $\beta$  = peak phase deviation in radians
  - $f_c$  = carrier frequency
  - $\delta$  = Dirac delta function
  - $N = 0, \pm 1, \pm 2, \dots$
  - $Q$  = quantity related to narrow band spectral peaking when  $D \approx 1, 2, 3, \dots$
  - $Q \approx 0.99$  for  $B_{SA} = 0.003 R$ ,  $Q \approx 0.9$  for  $B_{SA} = 0.03 R$

\*The spectrum analyzer resolution bandwidth term was added to the original equations.

A.5.e. Receiver Bandwidth

Receiver predetection bandwidth is typically defined as the points where the response to the carrier before demodulation is  $-3$  dB from the center frequency response. The carrier bandwidth response of the receiver is, or is intended to be, symmetrical about the carrier in most instances. [Figure A-15](#) shows the response of a typical older-generation telemetry receiver with RLC IF filters and a 1-MHz IF bandwidth selected. Outside the stated bandwidth, the response usually falls fairly rapidly, often 20 dB or more below the passband response at 1.5 to 2 times the passband response.

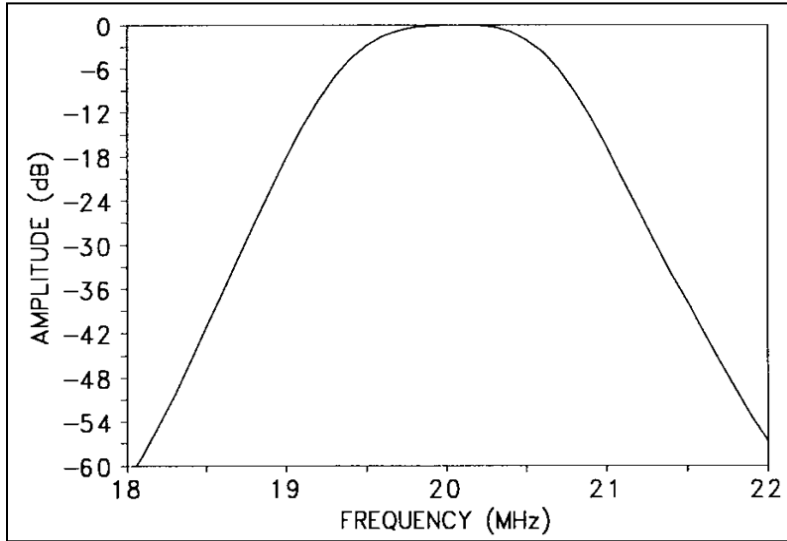

Figure A-15. Typical Receiver RLC IF Filter Response ( $-3$  dB Bandwidth = 1 MHz)

[Figure A-16](#) shows an overlay of an RLC IF filter and a SAW filter. Note that the SAW filter rolls off much more rapidly than the RLC filter. The rapid falloff outside the passband helps reduce interference from nearby channels and has minimal effect on data.

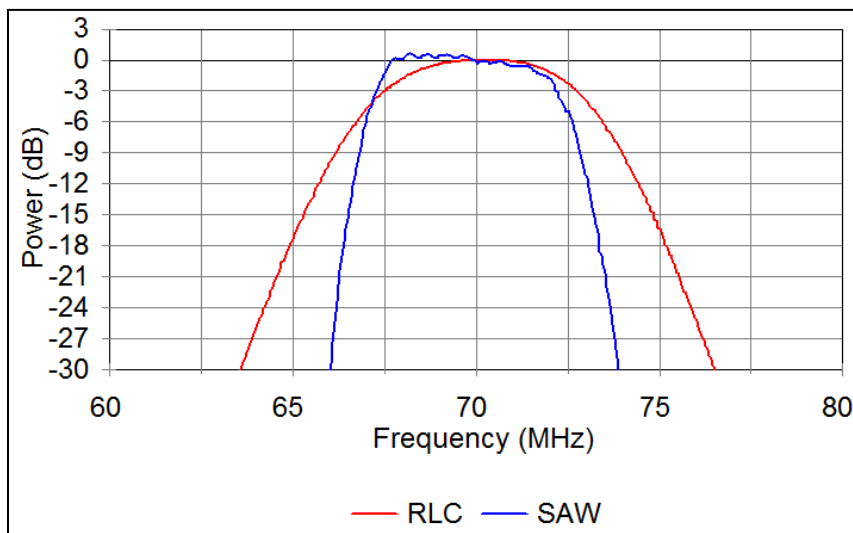

Figure A-16. RLC and SAW IF Filters



#### A.5.f. Receiver Noise Bandwidth

For the purpose of calculating noise in the receiver, the bandwidth must be integrated over the actual shape of the IF, which, in general, is not a square-sided function. Typically, the value used for noise power calculations is the  $-3$  dB bandwidth of the receiver.

#### A.5.g. Symmetry

Many modulation methods produce a spectrum that is asymmetrical with respect to the carrier frequency. Exceptions include FM/FM systems, RNRZ PCM/FM systems, and randomized SOQPSK-TG, and ARTM CPM systems. The most extreme case of asymmetry is due to single-sideband transmission, which places the carrier frequency at one edge of the occupied spectrum. If the spectrum is not symmetrical about the band center, the bandwidth and the extent of asymmetry must be noted for frequency management purposes.

#### A.5.h. FM Transmitters (alternating current-coupled)

Alternating current-coupled FM transmitters should not be used to transmit NRZ signals unless the signals to be transmitted are randomized. This is because changes in the ratio of 1s to 0s will increase the occupied bandwidth and may degrade the BER. When alternating current-coupled transmitters are used with RNRZ signals, it is recommended that the lower  $-3$  dB frequency response of the transmitter be no greater than the bit rate divided by 4000. For example, if a randomized 1-Mbps NRZ signal is being transmitted, the lower  $-3$  dB frequency response of the transmitter should be no larger than 250 Hz.

### A.6. **Spectral Occupancy Limits**

Telemetry applications covered by this standard shall use B99% to define occupied bandwidth and  $B_{-25\text{dBm}}$  as the primary measure of spectral efficiency. The spectra are assumed symmetrical about the center frequency unless otherwise specified. The primary reason for controlling the spectral occupancy is to control adjacent channel interference, thereby allowing more users to be packed into a given amount of frequency spectrum. The adjacent channel interference is determined by the spectra of the signals and the filter characteristics of the receiver.

#### A.6.a. Spectral Mask

One common method of describing the spectral occupancy limits is a spectral mask. The aeronautical telemetry spectral mask is described below. Note that the mask in this standard is different than the masks contained in the earlier versions of the Telemetry Standards. All spectral components larger than  $-[55 + 10 \times \log(P)]$  dBc (i.e., larger than  $-25$  dBm) at the transmitter output must be within the spectral mask calculated using the following equation:

$$M(f) = K + 90 \log R - 100 \log |f - f_c|; \quad |f - f_c| \geq \frac{R}{m} \quad \text{A-9}$$

where  $M(f)$  = power (dBc) at frequency  $f$  (MHz)  
 $K = -20$  for analog signals  
 $K = -28$  for binary signals  
 $K = -61$  for SOQPSK-TG

$K = -73$  for ARTM CPM

$f_c$  = transmitter center frequency (MHz)

$R$  = bit rate (Mbps) for digital signals or  $(\Delta f + f_{\max})(MHz)$  for analog FM signals

$m$  = number of states in modulating signal ( $m = 2$  for binary signals,  $m = 4$  for quaternary signals and analog signals)

$\Delta f$  = peak deviation

$f_{\max}$  = maximum modulation frequency

These bandwidths are measured using a spectrum analyzer with settings of 30-kHz resolution bandwidth, 300-Hz video bandwidth, and no max hold detector or averaging. Note that these settings are different than those listed in previous editions of the Telemetry Standards. The changes were made to get more consistent results with various bit rates and spectrum analyzers. The spectra measured with these settings give slightly larger power levels than with the previous settings; this is why the value of  $K$  was changed from  $-63$  to  $-61$  for SOQPSK signals. The power levels near center frequency should be approximately  $J - 10\log(R)$  dBc where  $J = -10$  for ARTM CPM,  $-12$  for SOQPSK-TG, and  $-15.5$  for PCM/FM signals. For a bit rate of 5 Mbps, the level is approximately  $-17$  dBc for ARTM CPM,  $-19$  dBc for SOQPSK-TG, and  $-22.5$  dBc for PCM/FM. If the power levels near center frequency are not within 3 dB of these values, then a measurement problem exists and the carrier power level (0 dBc) and spectrum analyzer settings should be verified.

$B_{-25dBm}$  is not required to be narrower than 1 MHz. The first term  $K$  in Equation [A-9](#) accounts for bandwidth differences between modulation methods. Equation [A-9](#) can be rewritten as  $M(f) = K - 10\log R - 100\log|(f-f_c)/R|$ . When Equation [A-9](#) is written this way, the  $10\log R$  term accounts for the increased spectral spreading and decreased power per unit bandwidth as the modulation rate increases. The last term forces the spectral mask to roll off at 30 dB/octave (100 dB/decade). Any error detection or error correction bits, which are added to the data stream, are counted as bits for the purposes of this spectral mask. The spectral masks are based on the power spectra of random real-world transmitter signals. For instance, the binary signal spectral mask is based on the power spectrum of a binary NRZ PCM/FM signal with peak deviation equal to 0.35 times the bit rate and a multipole premodulation filter with a  $-3$  dB frequency equal to 0.7 times the bit rate (see [Figure A-11](#)). This peak deviation minimizes the BER with an optimum receiver bandwidth while also providing a compact RF spectrum. The premodulation filter attenuates the RF sidebands while only degrading the BER by the equivalent of a few tenths of a dB of RF power. Further decreasing of the premodulation filter bandwidth will only result in a slightly narrower RF spectrum, but the BER will increase dramatically. Increasing the premodulation filter bandwidth will result in a wider RF spectrum, and the BER will only be decreased slightly. The recommended premodulation filter for NRZ PCM/FM signals is a multipole linear phase filter with a  $-3$  dB frequency equal to 0.7 times the bit rate. The unfiltered NRZ PCM/FM signal rolls off at 12 dB/octave so at least a three-pole filter (filters with four or more poles are recommended) is required to achieve the 30 dB/octave slope of the spectral mask. The spectral mask includes the effects of reasonable component variations (unit-to-unit and temperature).

### A.6.b. Spectral Mask Examples

[Figure A-17](#) and [Figure A-18](#) show the binary spectral mask of Equation [A-9](#) and the RF spectra of 5-Mbps RNRZ PCM/FM signals. The RF spectra were measured using a spectrum analyzer with 30-kHz resolution bandwidth, 300-Hz video bandwidth, and no max hold detector. The span of the frequency axis is 20 MHz. The transmitter power was 5 watts, and the peak deviation was 1750 kHz. The modulation signal for [Figure A-17](#) was filtered with a 4-pole linear-phase filter with  $-3$  dB frequency of 3500 kHz. All spectral components in [Figure A-17](#) were contained within the spectral mask. The minimum value of the spectral mask was  $-62$  dBc (equivalent to  $-25$  dBm). The peak modulated signal power levels were about 22.5 dB below the unmodulated carrier level ( $-22.5$  dBc). [Figure A-18](#) shows the same signal with no premodulation filtering. The signal was not contained within the spectral mask when a premodulation filter was not used.

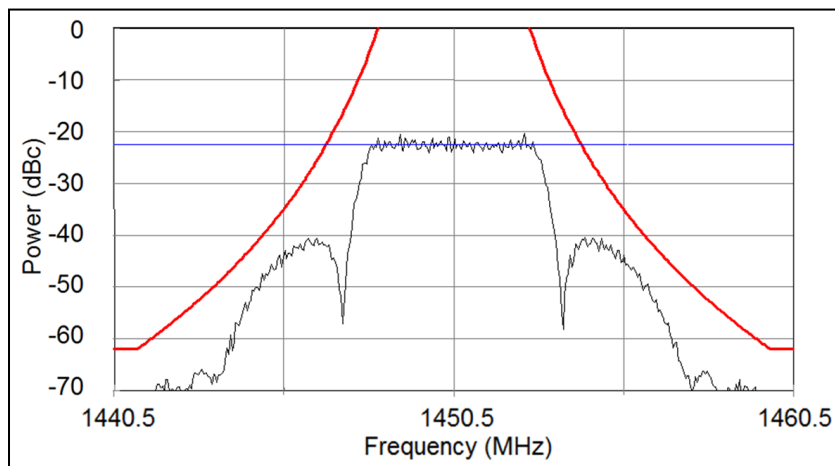

Figure A-17. Filtered 5-Mbps RNRZ PCM/FM Signal and Spectral Mask

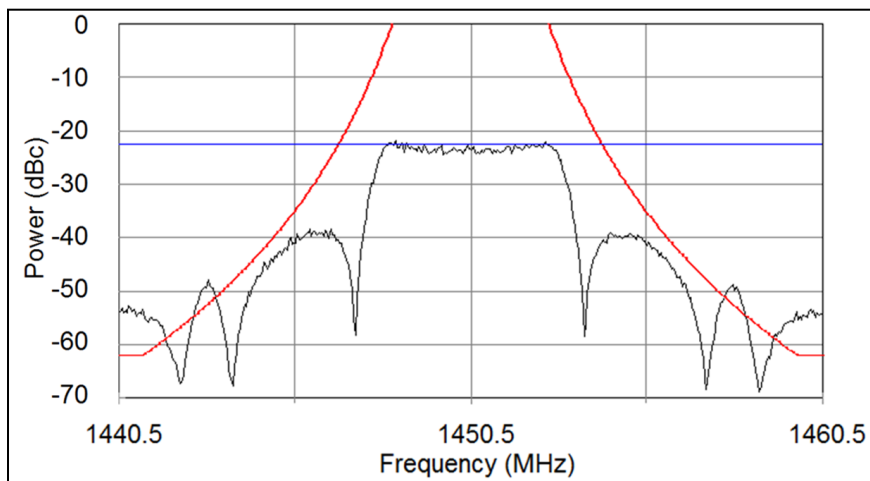

Figure A-18. Unfiltered 5-Mbps RNRZ PCM/FM Signal and Spectral Mask

[Figure A-19](#) shows the SOQPSK mask of Equation [A-9](#) and the RF spectrum of a 5-Mbps SOQPSK-TG signal. The transmitter power was assumed to be 5 watts in this example. The peak value of the SOQPSK-TG signal was about  $-19$  dBc. [Figure A-20](#) shows a typical 5-

Mbps ARTM CPM signal and its spectral mask. The peak value of the ARTM CPM signal was about  $-17$  dBc.

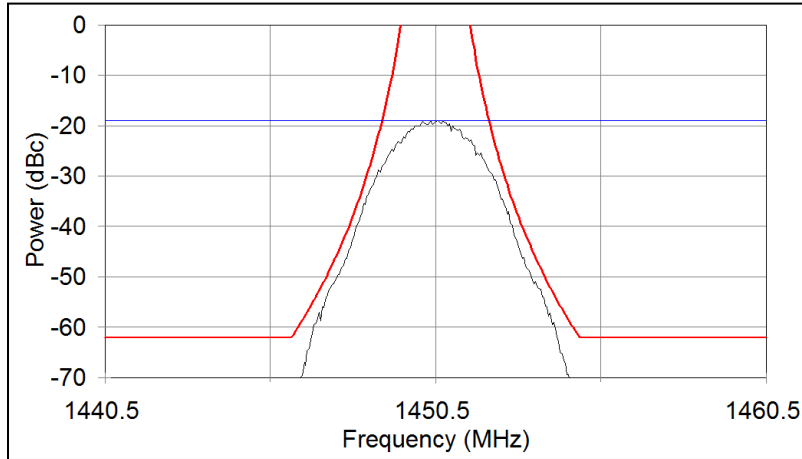

Figure A-19. Typical 5-Mbps SOQPSK TG Signal and Spectral Mask

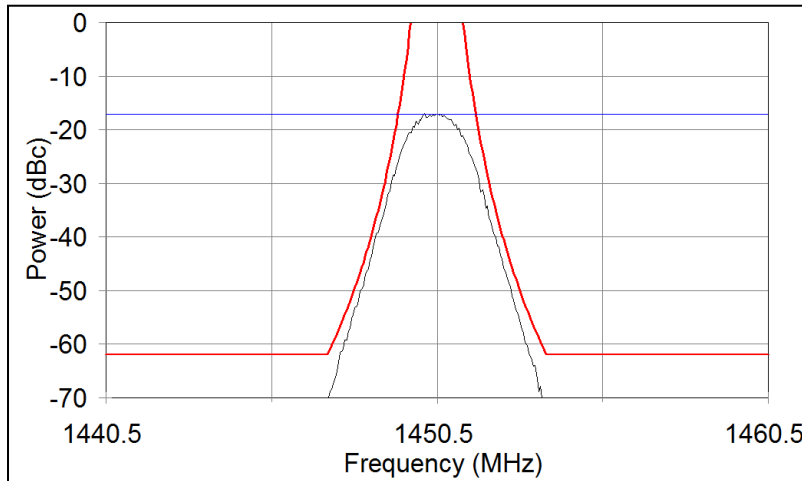

Figure A-20. Typical 5-Mbps ARTM CPM Signal and Spectral Mask

### A.7. Technical Characteristics of Digital Modulation Methods

[Table A-5](#) provides a summary of some of the technical characteristics of the modulation methods discussed in this summary.

<b>Table A-5. Characteristics of Various Modulation Methods</b>				
Characteristic	PCM/FM with single symbol detection	PCM/FM with multi-symbol detection	SOQPSK-TG	ARTM CPM
Occupied Bandwidth	1.16 bit rate	1.16 bit rate	0.78 bit rate	0.56 bit rate
Detection Efficiency ( $E_b/N_0$ for $BEP=1e-5$ )	11.8-15+ dB	9.5 dB	11.5-12 dB	12.5-13 dB
Synchronization time	100 to 10,000 bits	250 bits	200 to 5,000 bits	10,000 to 40,000 bits

$E_b/N_0$ for $BEP=1e-3$	9-12+ dB	6.5 dB	8.5 dB	10.5 dB
Phase noise susceptibility*	2	1	3	4
Co-channel interference susceptibility*	2	1	3	4
* Scale 1-4, 1 Being Best				

### A.8. SOQPSK-TG Characteristics

The SOQPSK is a family of constant envelope CPM waveforms defined by Hill.<sup>29</sup> The details of SOQPSK-TG are described in Subsection 2.3.3.3. The SOQPSK-TG signal amplitude is constant and the phase trajectory is determined by the coefficients in Table 2-4. Therefore, SOQPSK-TG can be implemented using a precision phase or frequency modulator with proper control of the phase trajectory. Figure A-21 illustrates the measured phase trajectory of an SOQPSK-TG signal. The vertical lines correspond approximately to the “bit” decision times.

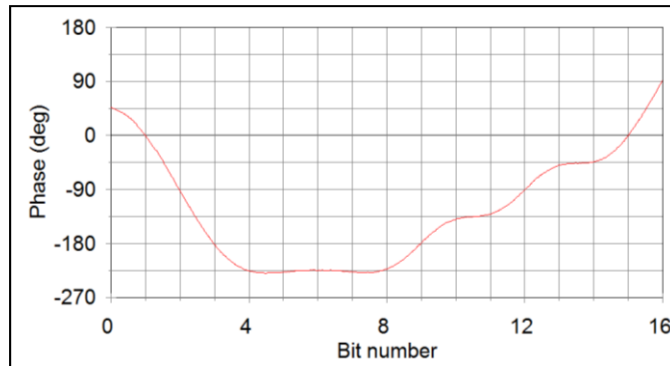

Figure A-21. Measured SOQPSK-TG Phase Trajectory

The power spectrum of a random 5-Mbps SOQPSK-TG signal is shown in Figure A-22.  $B_{-60dBc}$  of this 5-Mbps signal was about 7.34 MHz. Note that the maximum power level is about  $-19$  dBc.

<sup>29</sup> T.J. Hill. “An Enhanced, Constant Envelope, Interoperable Shaped Offset QPSK (SOQPSK) Waveform for Improved Spectral Efficiency.” Paper presented during 36th Annual International Telemetry Conference, San Diego, CA. October 23-26, 2000.

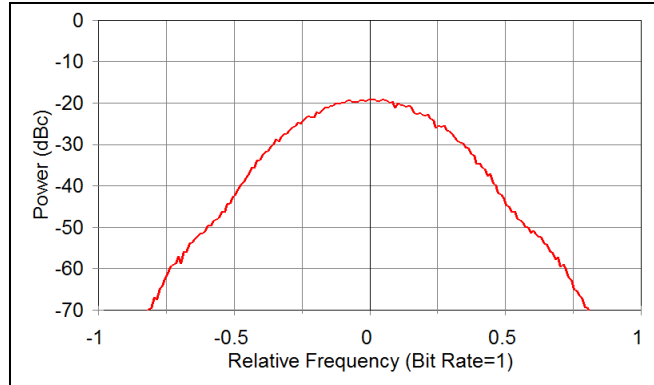
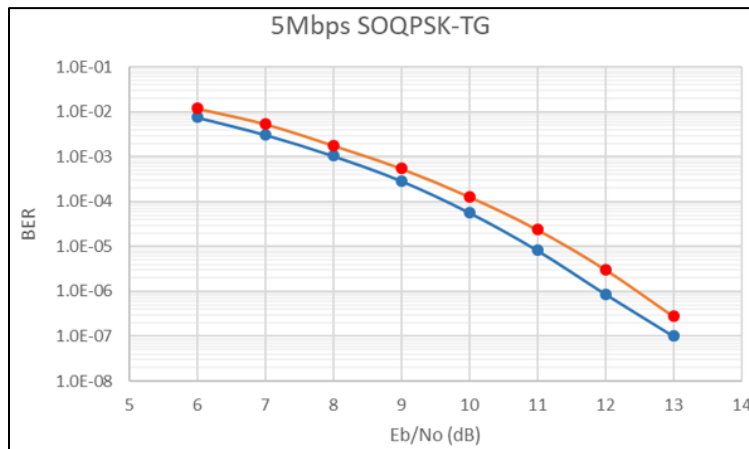

Figure A-22. SOQPSK-TG Power Spectrum (5 Mbps)

Figure A-23 shows the measured BEP versus signal energy per bit/noise power per Hz ( $E_b/N_0$ ) of two SOQPSK-TG modulator/demodulator combinations including nonlinear amplification and differential encoding/decoding in an AWGN environment with no fading. Other combinations of equipment may have different performance. Phase noise levels higher than those recommended in [Chapter 2](#) can significantly degrade the BEP performance.

Figure A-23. BEP vs.  $E_b/N_0$  Performance of 5 Mbps SOQPSK-TG

### A.9. Advanced Range Telemetry Continuous Phase Modulation Characteristics

The ARTM CPM is a quaternary signaling scheme in which the instantaneous frequency of the modulated signal is a function of the source data stream. The frequency pulses are shaped for spectral containment purposes. As defined for this standard, the modulation index alternates at the symbol rate between  $h=4/16$  and  $h=5/16$ . The purpose of alternating between two modulation indices is to maximize the minimum distance between data symbols, which results in minimizing the BEP. These particular modulation indices were selected as a good tradeoff between spectral efficiency and data-detection ability. [Figure A-24](#) shows the power spectrum of a 5-Mbps ARTM CPM signal and [Figure A-25](#) shows the measured BEP versus  $E_b/N_0$ . The maximum power level was about  $-19$  dBc.  $B_{-60\text{dBc}}$  of this 5-Mbps signal was about 5.54 MHz. Note that the power spectrum of ARTM CPM is about 25% narrower than that of SOQPSK-TG but the BEP performance is worse. The ARTM CPM modulation is also more susceptible to phase noise than SOQPSK-TG.

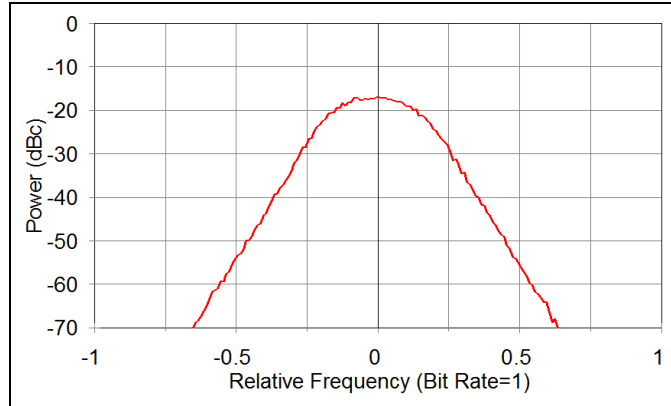

Figure A-24. Power Spectrum of 5 Mbps ARTM CPM

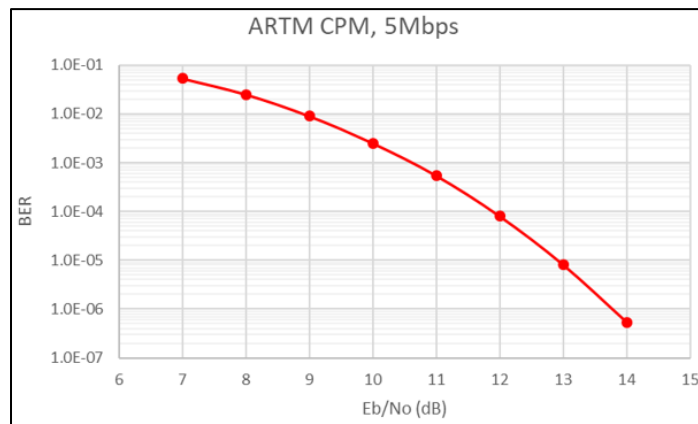

Figure A-25. BEP vs.  $E_b/N_0$  Performance of 5 Mbps ARTM CPM

### A.10. PCM/FM

The most popular telemetry modulation since 1970 is PCM/FM. The RF signal is typically generated by filtering the baseband NRZ-L signal and then frequency modulating a VCO. The optimum peak deviation is 0.35 times the bit rate ( $h=0.7$ ) and a good choice for a premodulation filter is a multi-pole linear phase filter with bandwidth equal to 0.7 times the bit rate. [Figure A-26](#) shows the power spectrum of a pseudo-random 5-Mbps PCM/FM signal with peak deviation of 1.75 MHz and a 3.5-MHz linear phase low-pass filter. Note that the spectrum is nearly flat from a frequency equal to  $-0.5$  times the bit rate to a frequency equal to  $+0.5$  times the bit rate. The power level near the center frequency is about  $-22.5$  dBc for a bit rate of 5 Mbps and the standard spectrum analyzer settings.

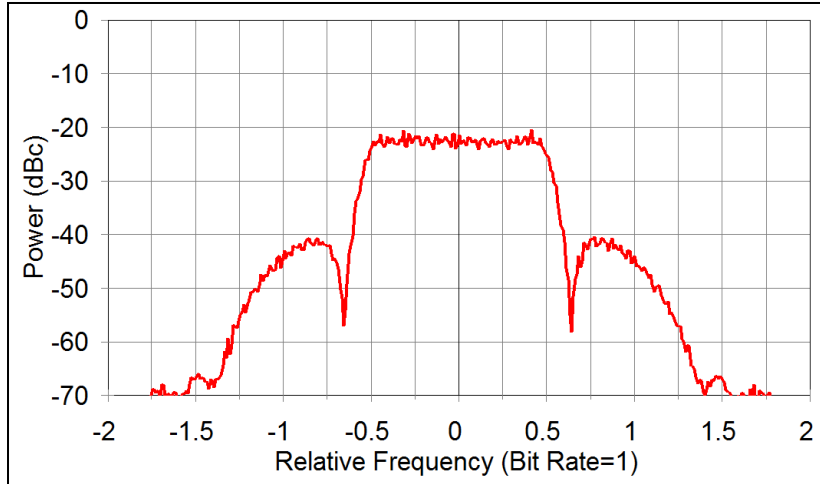

Figure A-26. Power Spectrum of 5 Mbps PCM/FM Signal

Figure A-27 shows the BEP versus  $E_b/N_0$  performance of 5-Mbps PCM/FM with a multi-symbol bit detector and with three different receivers/detectors. Note that an  $E_b/N_0$  of about 9 dB is required to achieve a BEP of about  $10^{-5}$  with the multi-symbol detector<sup>30,31</sup> while an  $E_b/N_0$  of about 12 to 14 dB is typically required to achieve a BEP of about  $10^{-5}$  with typical FM demodulators and single-symbol detectors. These are typical detection performance numbers and will vary depending upon receiver/demodulator implementations and whether or not trellis demodulation is used. The PCM/FM modulation method is fairly insensitive to phase noise.

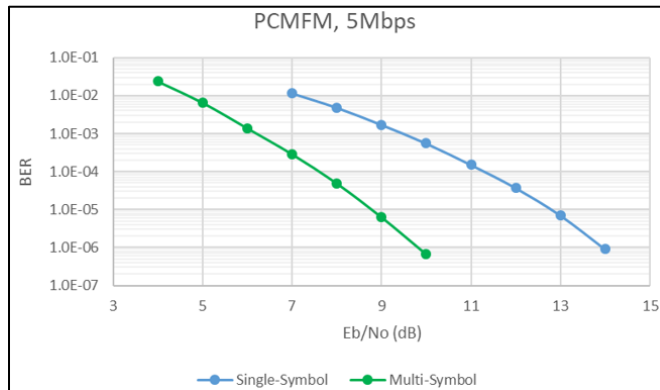

Figure A-27. BEP vs.  $E_b/N_0$  Performance of 5-Mbps PCM/FM

### A.11. Valid Center Frequencies Near Telemetry Band Edges

The telemetry bands and associated frequency ranges identified in Table 2-1 identify the frequency limits for each band. Telemetry transmitters cannot be centered at the band edges due to obvious out-of-band emissions (OOBE). Bit rate to the transmitter and modulation scheme drive the amount of separation required between the center frequency and the band edge. To

<sup>30</sup> Osborne, W. P. and M. B. Luntz. “Coherent and Noncoherent Detection of CPFSK,” IEEE Transactions on Communications, August 1974.

<sup>31</sup> Mark Geoghegan. “Improving the Detection Efficiency of Conventional PCM/FM Telemetry by using a Multi-Symbol Demodulator.” *Proceedings of the 2000 International Telemetry Conference*, Volume XXXVI, 675-682, San Diego CA, October 2000.



determine the amount of back-off required, the distance from the center of the spectral masks for each modulation scheme (see Subsection 2.3.6) to the intersection of the mask and the absolute limit of  $-25$  dBm must be calculated. To illustrate this, see Figure A-28. Using these calculations will assure that outside the specified telemetry bands no part of the modulated spectrum is over the absolute limit of  $-25$  dBm.

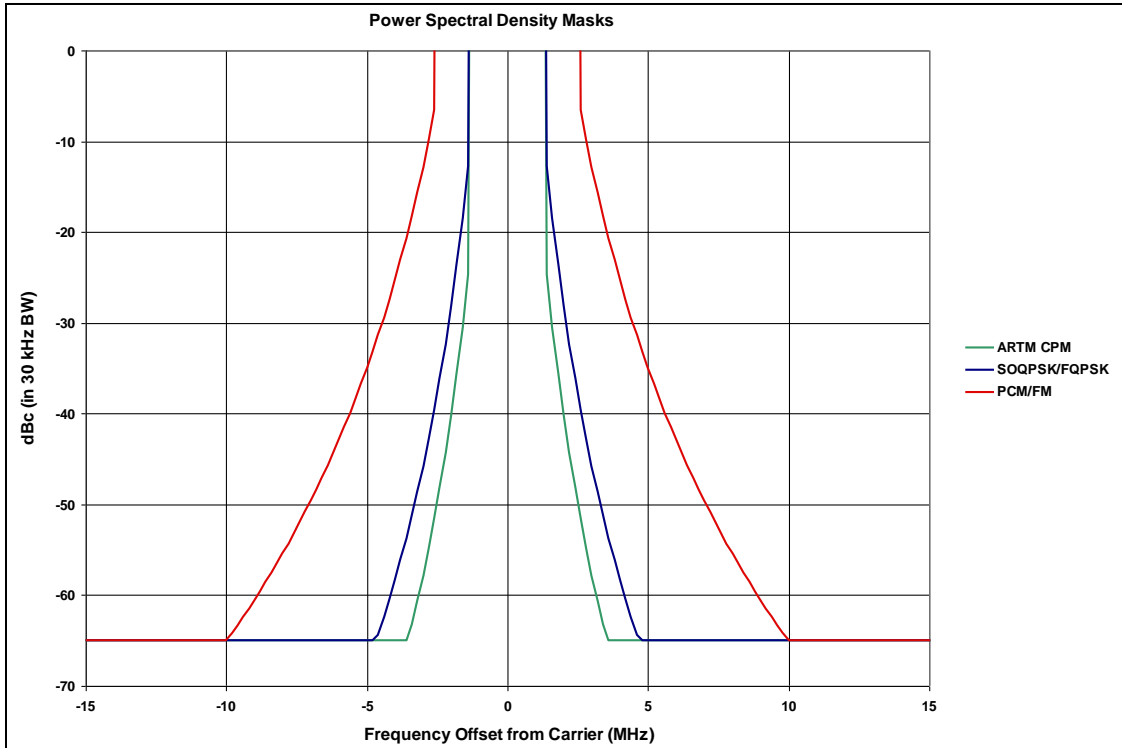

Figure A-28. Spectral Masks at  $-25$  dBm

The mask is calculated for all the modulation schemes at a bit rate of 5 Mbps with transmitter output power assumed to be 10 W. This transmitter operating with PCM/FM as its modulation scheme requires a back-off from band edge of 9.98 MHz; since channelization in these bands is limited to 0.5-MHz steps, this value is rounded up to 10 MHz. This same transmitter operating with SOQPSK will require 4.67 MHz, rounded up to 5 MHz, of back-off from band edge. Likewise, for ARTM-CPM the back-off is 3.54 MHz or 4 Mbps when rounded up. To further this example, if this was an L-band transmitter, viable carrier frequencies would be as specified in Table A-6.

Table A-6. L-Band Frequency Range (10 W, 5 Mbps)	
Modulation Type	Viable L-Band Frequency Range
PCM/FM	1445-1515 MHz
SOQPSK-TG	1440-1520 MHz
ARTM CPM	1439-1521 MHz

For a given modulation scheme and transmitter output power, as the bit rate increases, the amount of back-off from the band edge also increases. Figure A-29 illustrates this point.

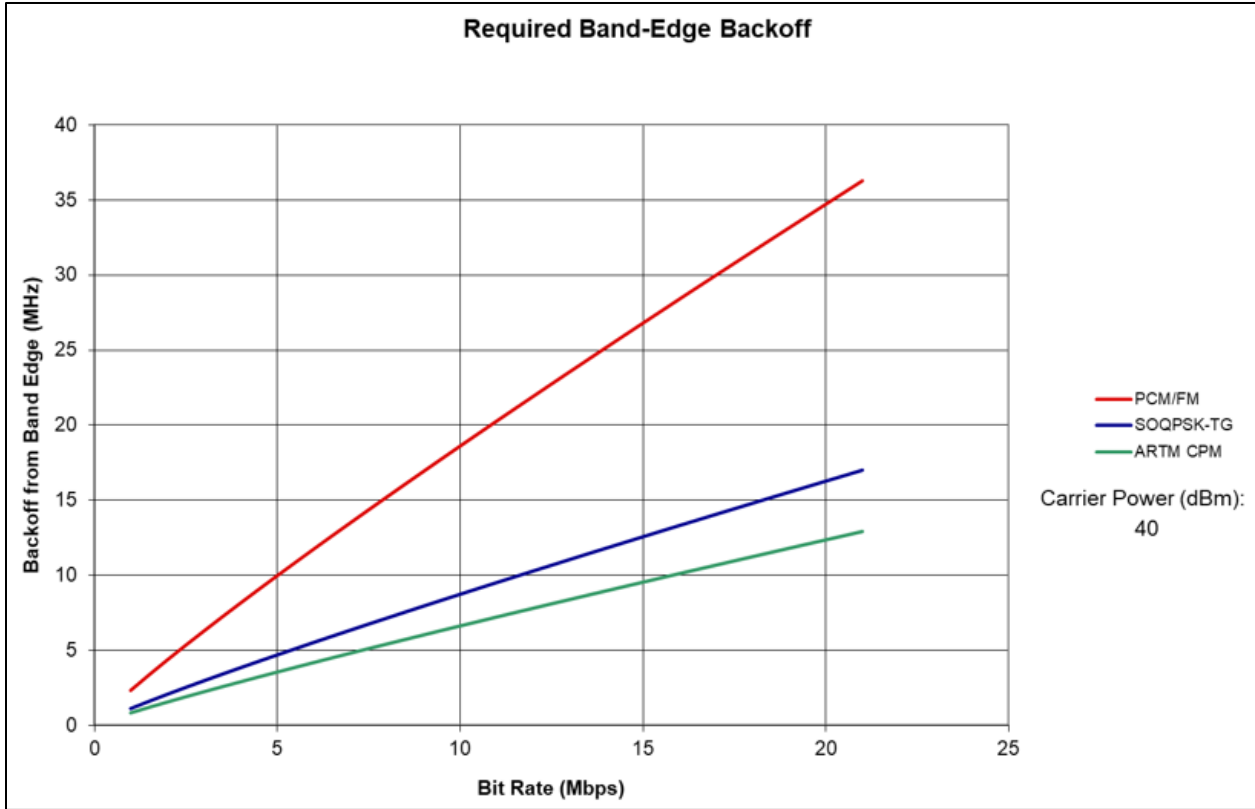

Figure A-29. Bit Rate vs. Band Edge Back-off



**NOTE**

For ease in making calculations, an Excel spreadsheet application can be used. [Table A-7](#) provides an example of a 10-watt transmitter (+40 dBm) operating at 1 Mbps in L-band and S-band using the formulas in the spreadsheet. The Excel file that created [Table A-7](#) can be downloaded [here](#) and used for interactive calculations.

The input values for transmitter output power and bit rate are in the cells highlighted in yellow. The amount of back-off will be displayed in the cells highlighted in light blue. Additionally, each telemetry band is displayed with the useable carrier frequency range for each modulation scheme given in blue.

**Table A-7. Valid Center Frequency, Band Edge Back-Off**

Carrier Power or EIRP (dBm):		40	Input Number	
Mask floor (at this nominal TX power):		-65	dBc	
		<b>PCM/FM</b>	<b>SOQPSK</b>	<b>ARTM CPM</b>
Bit Rate (Mbps):		1.00	1.00	1.00
K =		-28	-61	-73
m =		2	4	4
Bit Rate (bps)		1.00E+06	1.00E+06	1.00E+06
Mask hits floor at offset of (MHz)		2.34	1.10	0.83
Band-edge backoff (MHz, rounded to nearest 0.5 MHz)		2.5	1.5	1
				<b>Result</b>
<b>L-Band</b>	Band Edge, Lower (MHz)	1435		
	Band Edge, Upper (MHz)	1525		
	Lower center freq. at this bit rate (MHz)	1437.5	1436.5	1436.0
	Upper center freq. at this bit rate (MHz)	1522.5	1523.5	1524.0
<b>L-Band</b>	Band Edge, Lower (MHz)	1780		
	Band Edge, Upper (MHz)	1850		
	Lower center freq. at this bit rate (MHz)	1782.5	1781.5	1781.0
	Upper center freq. at this bit rate (MHz)	1847.5	1848.5	1849.0
<b>S-Band</b>	Band Edge, Lower (MHz)	2200		
	Band Edge, Upper (MHz)	2290		
	Lower center freq. at this bit rate (MHz)	2202.5	2201.5	2201.0
	Upper center freq. at this bit rate (MHz)	2287.5	2288.5	2289.0
<b>S-Band</b>	Band Edge, Lower (MHz)	2360		
	Band Edge, Upper (MHz)	2395		
	Lower center freq. at this bit rate (MHz)	2362.5	2361.5	2361.0
	Upper center freq. at this bit rate (MHz)	2392.5	2393.5	2394.0
<b>C-Band</b>	Band Edge, Lower (MHz)	4400		
	Band Edge, Upper (MHz)	4940		
	Lower center freq. at this bit rate (MHz)	4402.5	4401.5	4401.0
	Upper center freq. at this bit rate (MHz)	4937.5	4938.5	4939.0
<b>C-Band</b>	Band Edge, Lower (MHz)	5091		
	Band Edge, Upper (MHz)	5150		
	Lower center freq. at this bit rate (MHz)	5093.5	5092.5	5092.0
	Upper center freq. at this bit rate (MHz)	5147.5	5148.5	5149.0

This page intentionally left blank.

## APPENDIX 2-B

## Properties of the Differential Encoder Specified in IRIG Standard 106 for OQPSK Modulations

### B.1. Introduction

This appendix summarizes a study of the differential encoder originally adopted by the US DoD ARTM project and the RCC and incorporated into the IRIG 106 for Feher's Quadrature Phase Shift Keying (FQPSK)-B modulation. The study, performed by Mr. Robert Jefferis of the TYBRIN Corporation, was prompted by inquiries from industry representatives who were concerned that this particular differential code was not associated with commercial telecommunication standards and the fact that manufacturers had experienced confusion over correct implementation. The study results shown in this appendix prove the code to be robust, reliable, and applicable to SOQPSK-TG as well as FQPSK-B and FQPSK-JR.<sup>32</sup>

This appendix is organized along the following structure. Section [B.2](#) describes the need for differential encoding. Section [B.3](#) explains the IRIG-106 differential code for OQPSK. Section [B.4](#) demonstrates differential code's invariance with respect to constellation rotation. Section [B.5](#) shows the differential decoder to be self-synchronizing. Section [B.6](#) reviews the differential decoder's error propagation characteristics. Section [B.7](#) analyzes a recursive implementation of the differential code. Section [B.8](#) describes use of this code with frequency modulator-based SOQPSK transmitters. Section [B.9](#) provides a summary of the findings. A description of the implementation of the entire coding and decoding process can be seen at [B.10](#) to this appendix.

### B.2. The Need For Differential Encoding

Practical carrier recovery techniques like Costas loops and squaring loops exhibit a troublesome M-fold carrier phase ambiguity. The following paragraphs provide a description of ambiguity problems and how to overcome them.

[Figure B-1](#) shows a simplified quadriphase transmission system that is one of the methods recommended for transparent point-to-point transport of a serial binary data stream. Transparent means that only revenue-bearing data is transmitted. There is no in-line channel coding nor is special bit pattern insertion allowed. The assumption is made for an NRZ-L data stream containing the bit sequence  $b(nT_b)$  transmitted at rate  $r_b = 1/T_b$  bits per second. For QPSK and OQPSK modulations, the bit stream is divided into subsets  $e$  containing even-numbered bits and  $o$  containing odd numbered bits. The transmission rate associated with the split symbol streams is  $r_s = r_b/2$  symbols per second. Symbol values are converted to code symbols by the differential encoder described in Section [B.3](#). A baseband waveform generator converts the digital symbol time series into continuous time signals suitable for driving the vector modulator as prescribed for the particular modulation in use. Thus, each subset modulates one of two orthogonal subcarriers, the in-phase ( $I$ ) channel, and the quadrature ( $Q$ ) channel. The modulator combines these subcarriers, creating a phase-modulated RF signal  $S(t)$ . On the receive side, demodulation separates the subcarriers, translates them back to baseband, and constructs

---

<sup>32</sup> FQPSK-JR is an FQPSK variant developed by Mr. Robert Jefferis, TYBRIN Corporation, and Mr. Rich Formeister, RF Networks, Inc.

replicas of the code symbol series  $E'(nT_s)$  and  $O'(nT_s)$ . Decoding reverses the encoding process and a multiplexer recreates a replica of the bit stream  $b'(nT_b)$ .

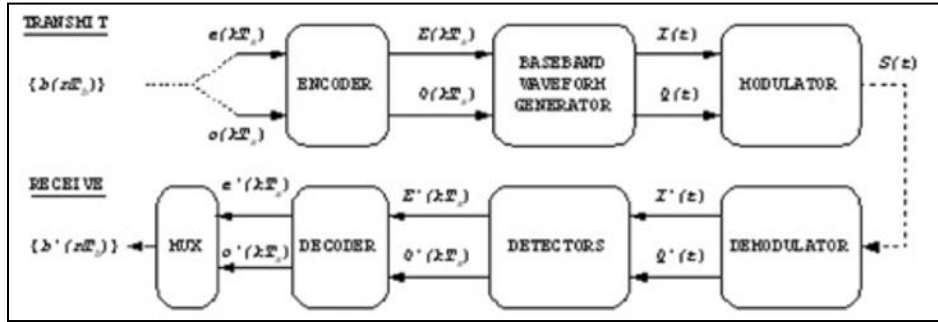

Figure B-1. Transmission System

Most QPSK and OQPSK systems employ coherent demodulation. [Figure B-2](#) is a simplified diagram of commonly used modulation and demodulation structures. Note the optional single-bit delay shown in the odd symbol path. This creates the significant difference between QPSK and OQPSK, the delay being inserted to create OQPSK.<sup>33</sup> Practical carrier recovery techniques like Costas loops and squaring loops exhibit a troublesome M-fold phase ambiguity (M=4 for QPSK and OQPSK).<sup>34</sup> Each time the demodulator carrier synchronizer phase locks to the modulator local oscillator its absolute phase relationship to the local oscillator contains the offset term  $\beta$ , which can take on values of  $0, \pm \pi/2, \text{ or } \pi$  radians.<sup>35</sup>

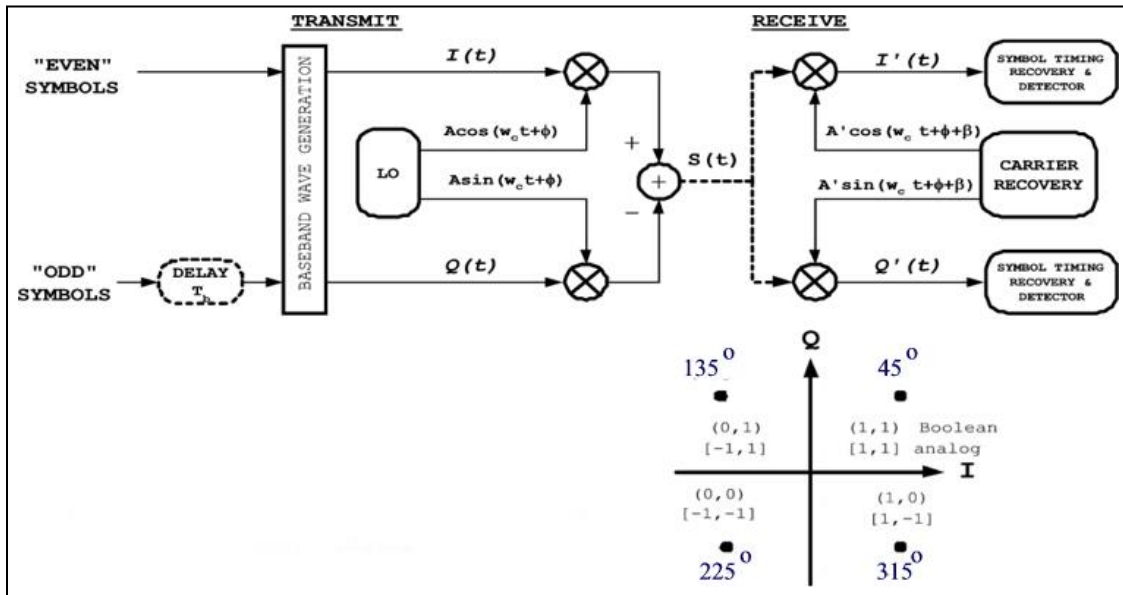

Figure B-2. OQPSK 106 Symbol-to-Phase Mapping Convention

<sup>33</sup> The delay can be inserted into either channel. The IRIG-106 convention and most published literature regarding FQPSK and SOQPSK indicate the delay in the odd (or Q) channel.

<sup>34</sup> Proakis, J. G. and M. Salehi. *Digital Communications*. 5<sup>th</sup> Edition. Boston: McGraw-Hill, 2008.

<sup>35</sup> The initial offset angle  $\phi$  is generally unknown and uncontrolled; it is tracked by the carrier recovery circuitry and the symbol timing circuits automatically ignore.

The symbol detectors have insufficient information to determine which phase offset exists. They always interpret demodulator output with the assumption that  $\beta=0$ . The resulting constellation axis rotations and their impact on demodulator output are shown at [Figure B-3](#) and [Table B-1](#). The 180° rotation is symmetric. The Axis (subcarrier) assignment is unchanged but the sense (polarity) of both axes gets reversed. The 90° and 270° rotations are asymmetric. Axis assignment is swapped and one axis polarity is reversed in each case.

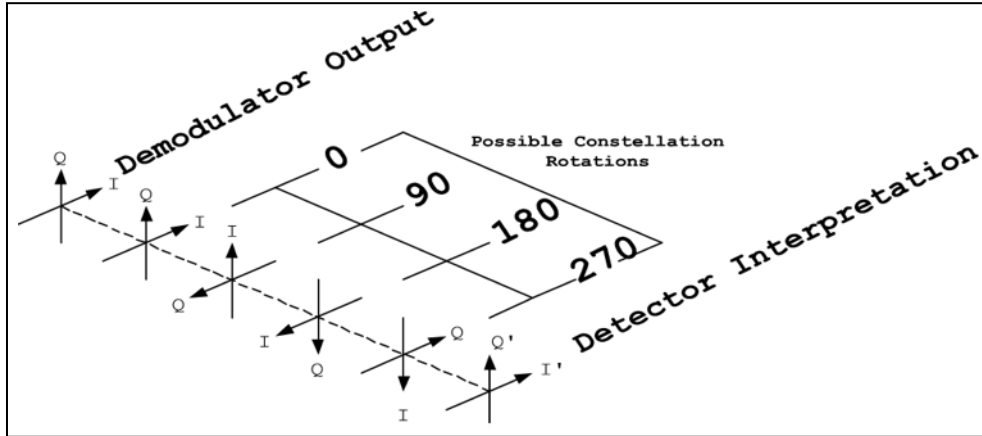

Figure B-3. Detection Ambiguity

Table B-1. Constellation Axis Rotations		
Rotation	+I'	+Q'
0	I	Q
$\pi/2$	-Q	I
$\pi$	-I	-Q
$3\pi/2$	Q	-I

### B.3. A Simple Solution To The Carrier Phase Ambiguity Problem

Differential encoding has been used to work around the carrier ambiguity for many years. For phase modulations, source data is coded such that phase differences rather than absolute phase coordinates become the information-bearing attribute of the signal. The QPSK and OQPSK modulations use *I* and *Q* independently, with each channel transporting one symbol stream. Starting with the first binary digit, bit 0, even-numbered bits form the sequence  $\{e_k\}$  and odd-numbered bits form the sequence  $\{o_{k+1}\}$  where the counting index is changed from the bit index *n* to the symbol pair index

$$k = 2n \quad k \in \{0,2,4,6,\dots\} \quad \text{B-1}$$

[Figure B-4](#) illustrates how QPSK modulators process bits in pairs (dibits), mapping and asserting time coincident symbol phase coordinates ( $I_k, Q_k$ ).<sup>36</sup> Phase state changes commence and end on symbol interval timing boundaries, each state taking on one of four possible values at detector decision instants; however, the case of interest is shown in [Figure B-5](#).

<sup>36</sup> Rectangular I and Q baseband waveforms are used only for illustration.

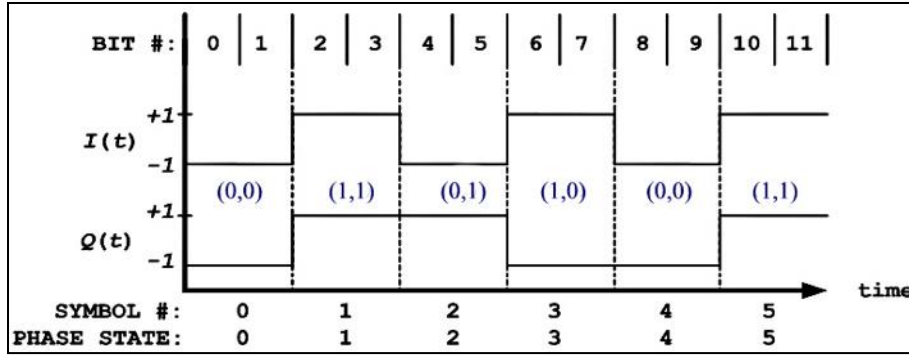

Figure B-4. QPSK State Timing

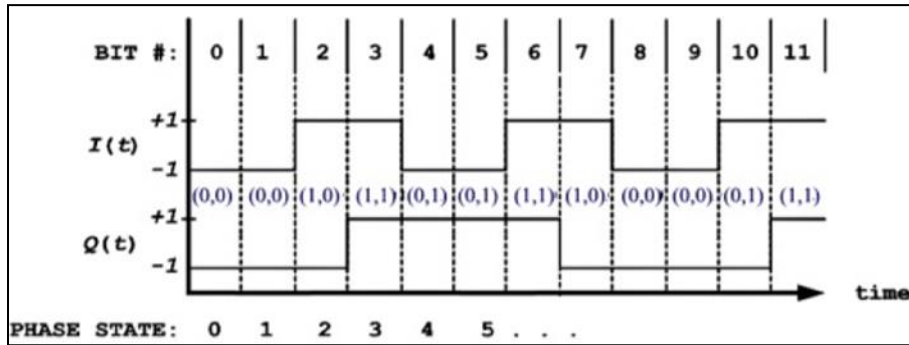

Figure B-5. OQPSK State Timing

The Q channel half-symbol delay causes OQPSK phase trajectories to evolve on a half-symbol (bit) rate basis. For the particular cases of FQPSK and SOQPSK-TG, carrier phase either remains unchanged or changes by  $\pm\pi/4$  or  $\pm\pi/2$  radians over the pending bit interval.

The OQPSK inter-channel delay might at first seem a difficult complication because it creates additional ambiguity; in other words, the receiver must resolve relative inter-channel delay; however, as shown below, this is not a problem.

The differential encoding rule adopted in IRIG-106 for OQPSK appears in Feher<sup>37</sup> and is therein attributed to Clewer<sup>38</sup> and Weber.<sup>39</sup> Bit by bit, the code symbol sets  $\{E_k\}$  and  $\{O_{k+1}\}$  are formed with the Boolean expressions:

$$E_k \equiv e_k \oplus \overline{O_{k-1}} \quad (\text{B-2a})$$

$$O_{(k+1)} \equiv o_{k+1} \oplus E_k \quad (\text{B-2b})$$

B-2

<sup>37</sup> Kamilo Feher. *Digital Communications: Satellite/Earth Station Engineering*. Englewood Cliffs: Prentice-Hall, 1983, pp. 168-170.

<sup>38</sup> R. Clewer. "Report on the Status of Development of the High Speed Digital Satellite modem", RML-009-79-24, Spar Aerospace Limited, St. Anne de Bellevue, P.Q., Canada, November 1979. Quoted in Kamilo Feher. *Digital Communications: Satellite/Earth Station Engineering*. Englewood Cliffs: Prentice-Hall, 1983.

<sup>39</sup> W. J. Weber III. "Differential Encoding for Multiple Amplitude and Phase Shift Keying Systems." In IEEE Transactions on Communications, Vol. COM-26, No. 3, March 1978.



Two bits are coded for each value of  $k$  in a two-step process. First, the even symbol  $E_k$  is coded with current bit  $e_k$ . Then the next bit,  $o_{k+1}$  becomes current and the odd symbol  $O_{k+1}$  is computed. In each code set the exclusive-or operator is applied to the state defining variables just like binary phase shift keying (BPSK) differential encoding. Unlike BPSK however, the current source bit and the most recent code symbol from the other channel determine adjacent phase transitions. The inverted code symbol in Equation [B-2a](#) introduces asymmetry in the equations. Its significance will become evident in the next section.

The code symbol sets  $\{E\}$  and  $\{O\}$  are applied to the  $I$  and  $Q$  channels of the OQPSK modulator. The initial assignment of  $\{E\}$  to either  $I$  or  $Q$  can be made arbitrarily; however, with this code definition, once the choice is made at the modulator, decoding will fail if channel assignment conventions change anywhere during the transmission or decoding processes. Thus, the assignment convention must extend to the physical modulator and demodulator. The IRIG-106 assigns  $I$  to the physical  $I$  subcarrier (also known as the “real” or “cosine” subcarrier) and  $Q$  is applied to the physical  $Q$  subcarrier (also known as the “imaginary” or “sine” subcarrier). In order to stress this assignment convention, IRIG-106 expresses Equation [B-2](#) explicitly in terms of the  $I$  and  $Q$  channel variables:

$$I_k \equiv e_k \oplus \overline{Q}_{(k-1)} \quad (\text{B-3a})$$

B-3

$$Q_{(k+1)} \equiv o_{(k+1)} \oplus I_k \quad (\text{B-3b})$$

Decoding is straightforward. When  $\beta=0$ ,  $I'=I$ , and  $Q'=Q$ , inspection of the following truth tables reveals simple decoding instructions:

Equation [B-3a](#)

Equation [B-3b](#)

$I_k$	$\overline{Q}_{(k-1)}$	$e_k$	$Q_{(k+1)}$	$I_k$	$o_{(k+1)}$	
0	0	0	0	0	0	
0	1	1	1	0	1	$\Rightarrow$ decoding equation
1	0	1	0	1	1	
1	1	0	1	1	0	

Equation [B-3](#)

$$e'_k = I'_k \oplus \overline{Q}'_{k-1} \quad (\text{B-4a})$$

B-4

$$o'_{k+1} = Q'_{k+1} \oplus I'_k \quad (\text{B-4b})$$

The equations at [B-3](#) may not convey an intuitive sense of the shift from absolute phase states to phase differences. Extending [B-3a](#) backwards in time by substituting [B-3b](#) into [B-3a](#) results in:

$$I_k = e_k \oplus (\overline{o_{k-1} \oplus I_{k-2}}) = I_{k-2} \oplus (\overline{e_k \oplus o_{k-1}}) \quad (\text{B-5})$$

Similarly, for the next bit interval the results are:

$$Q_{k+1} = o_{k+1} \oplus (\overline{e_k \oplus \overline{Q}_{k-1}}) = Q_{k-1} \oplus (\overline{o_{k+1} \oplus e_k}) \quad (\text{B-6})$$

This recursive form clearly shows that on a bit-by-bit basis, the current and most recent bits control phase trajectory motion, not absolute phase. Note that [B-5](#) and [B-6](#) do not define the sign of a phase change. Predictable decoder output requires that two additional conventions be established and maintained. Boolean logic polarity conventions used throughout the system must be consistent. The IRIG-106 assumes positive true logic. Finally, sign conventions and channel assignment used within the transmitter (baseband signal generator and modulator) and the receiver (demodulator) must be constrained to produce a consistent code symbol-to-phase mapping convention. The IRIG-106 convention is shown in [Figure B-2](#). For example, if {b} were to consist entirely of logic one values, i.e., a run of 1s, the differential encoding process and mapping convention will produce the phase trajectory shown in [Table B-2](#).

<b>Table B-2. Response to Run of 1s</b>							
<b>n</b>	<b>b(n)</b>	<b>k</b>	<b>I<sub>k</sub></b>	<b>Q<sub>k-1</sub></b>	<b>Q<sub>k+1</sub></b>	<b>Phase (deg)</b>	<b>Phase Δ</b>
0	1	0	0	0*		225*	
1	1				1	135	$-\pi/2$
2	1	1	1	1		45	$-\pi/2$
3	1				0	315	$-\pi/2$
4	1	2	0	0		225	$-\pi/2$
5	1				1	135	$-\pi/2$
* denotes assumed initial conditions							

The trajectory spins clockwise, and the phase is retarded by  $90^\circ$  during each bit interval.<sup>40</sup> Obviously, any single (unbalanced) sign change and any change to the mapping convention will alter the trajectory.

#### **B.4. Immunity to Carrier Phase Rotation**

The equations at [B-3](#) and [B-4](#) are invariant with respect to cardinal constellation rotation as shown in the following.

Proof:

The  $\beta=0$  case is decoded correctly by definition according to equations [B-5](#) and [B-6](#). At [Table B-1](#), when  $\beta = \pi$  there is no axis swap but the decoder is presented with

$$\begin{aligned} I'_k &= \bar{I}_k \\ Q'_{k+1} &= \bar{Q}_{k+1} \end{aligned}$$

Decoding will progress as follows:

Step 1. Even channel; apply Equation [B-4a](#);

$$e'_k = I'_k \oplus \bar{Q}'_{k-1} = \bar{I}_k \oplus Q_{k-1} = I_k \oplus \bar{Q}_{k-1} = e_k$$

<sup>40</sup> FQPSK-B, FQPSK-JR, and SOQPSK-TG modulations respond to a run of 1s with an S(t) that is ideally, a pure tone at frequency  $f_c - r_b/4$  Hz. This is referred as “lower sideband” mode. Similarly, a run of zeroes will produce a constant anti-clockwise trajectory spin and a tone at  $f_c + r_b/4$  Hz (“upper sideband” mode).

Step 2. Odd channel; apply equation [B-4b](#);

$$o'_{k+1} = Q'_{k+1} \oplus I'_k = \bar{Q}_{k+1} \oplus \bar{I}_k = Q_{k+1} \oplus I_k = o_{k+1}$$

Thus, symmetric rotation is transparent to the code. When  $\beta=\pi/2$  the decoder sees the following.

$$\begin{aligned} I'_k &= \bar{Q}_{k-1} \\ Q'_{k+1} &= I_k \end{aligned}$$

Decoding takes place in the same sequence:

Step 1. Even channel, apply equation [B-4a](#);

$$e'_k = I'_k \oplus \bar{Q}'_{k-1} = \bar{Q}_{k-1} \oplus \bar{I}_k = I_k \oplus Q_{k-1} = o_{k-1}$$

Step 2. Odd channel, apply equation [B-4b](#);

$$o'_{k+1} = Q'_{k+1} \oplus I'_k = I_k \oplus \bar{Q}_{k-1} = e_k$$

In this case the bit sequence is recovered correctly and the code definition coupled with consistent sign conventions automatically compensates for the asymmetric rotation by reversing the application order of [B-4a](#) and [B-4b](#). As a result, the output indices are shifted back in time one bit period. Asymmetric rotation causes a one-bit delay in the decoding process. Finally, the same result is seen when  $\beta=3\pi/2$ :

$$\begin{aligned} I'_k &= Q_{k-1} \\ Q'_{k+1} &= \bar{I}_k \end{aligned}$$

Step 1. Even channel; apply equation [B-4a](#);

$$e'_k = I'_k \oplus \bar{Q}'_{k-1} = Q_{k-1} \oplus I_k = I_k \oplus Q_{k-1} = o_{k-1}$$

Step 2. Odd channel; apply equation [B-4b](#);

$$o'_{k+1} = Q'_{k+1} \oplus I'_k = \bar{I}_k \oplus Q_{k-1} = I_k \oplus \bar{Q}_{k-1} = e_k$$

In all cases the decoder correctly reproduces the original bit sequence. Decoding is instantaneous for symmetric rotations but it is delayed by one bit in 2 out of 4 possible asymmetric rotation startup scenarios.

The need for consistent function assignment now becomes clear. Application of [B-4b](#) to a code symbol formed with [B-3a](#) produces the complement of the original bit. Likewise, application of [B-4a](#) to a symbol coded with [B-3b](#) inverts the result.

At this point, the OQPSK inter-channel delay ambiguity mentioned in Section [B.2](#) has not been resolved. The roles of  $I'$  and  $Q'$  reverse with asymmetric rotations and there is no way to determine when this occurs; however, as long as the code symbol time sequence is preserved at the decoder and the roles of  $I'$  and  $Q'$  do not get reversed in terms of the application of [B-4a](#)

and [B-4b](#), inter-channel delay is transparent to the code with respect to reconstruction of the original data sequence.<sup>41</sup>

### B.5. Initial Values

Equations [B-3](#) and [B-4](#) do not impose any implementation constraints on initial values when encoding or decoding starts. To confirm this it is assumed that hardware power-up (or initial data presentation) may cause encoding to commence with either channel. It is further assumed that no provisions for specific initial values in encoder and decoder state memories have been made. If coding starts with  $I$  (see equation [B-3a](#)), the first code symbol will be computed:

$$\|I_0\| = e_0 \oplus \langle \bar{Q}_{-1} \rangle$$

where  $\langle . \rangle$  denotes an unknown initial value and double vertical bars denote computed values influenced by initial values. Encoding equations [B-3a](#) and [B-3b](#) will progress as follows:

$$\|Q_1\| = o_1 \oplus \|I_0\|$$

$$\|I_2\| = e_2 \oplus \|Q_1\|$$

The initial values do establish the absolute sense of code symbols for the duration of transmission; but, on both ends of the process, two of three terms in every equation are affected consistently by the initial value, which by symmetry has no effect on the outcome of exclusive-or operations. Obviously, identical results occur if the encoder starts with  $Q$ . Independent of starting channel and initial value then, the first and all subsequent adjacent code symbol pairs contain valid state change information.

Initial decoder values can produce errors. Again starting with  $I$ , and using equations [B-4a](#) and [B-4b](#), decoding will progress as follows:

$$\|e'_0\| = I'_0 \oplus \langle \bar{Q}'_{-1} \rangle$$

$$o'_1 = Q'_1 \oplus I'_0$$

It is seen that on the second cycle the initial value of the decoder has been flushed out. At most, one bit will be decoded in error. Similarly, if decoding starts with  $Q$ , output will progress:

$$\|o'_1\| = Q'_1 \oplus \langle I'_0 \rangle$$

$$e'_2 = I'_2 \oplus \bar{Q}'_1$$

Again, only the first decoded bit may be incorrect. The conclusion, then, is that initial values can produce at most one decoded bit error; however, there is another source of startup errors that is seen as an initial value problem. Section [B.4](#) showed that odd phase rotations ( $\pi/2$

---

<sup>41</sup> If for some reason the system application requires that one can determine whether a specific symbol was originally transmitted via I or Q, then this code is not appropriate.

and  $3\pi/2$ ) cause a single bit delay in the decoder. Examining this further, the first symbol index value will be  $k = 0$ . If the decoder starts with equation [B-4a](#), the first decoded bit will be:

$$e'_0 = I'_0 \oplus \langle \overline{Q}'_{-1} \rangle = I_0 \oplus \langle Q_{-1} \rangle = \langle o_{-1} \rangle$$

If the decoder starts with equation [B-4b](#) the first result will be:

$$o'_1 = Q'_1 \oplus I'_0 = I_0 \oplus \langle \overline{Q}'_{-1} \rangle = \|e_0\|$$

The first case produces the aforementioned delay. The decoder emits an extra bit. The second bit emitted is actually the first bit of the sequence reconstruction and is still subject to the single initial value error probability of startup processing. The latter case does not produce a delay; it only presents the possibility of a first bit decoding error.

## B.6. Error Propagation

Differential encoding incurs a bit error penalty because received code symbols influence more than one decoded bit. First consider a single-symbol detection error in current symbol  $E'$  that is labeled  $\varepsilon_k$ . The following sequence of decoding steps shows how the error propagates. Since the  $E$  channel was chosen as current, decoding starts with equation [B-4a](#). The single detection error creates two sequential decoding errors. By symmetry we can state that the same result occurs if a single error occurs in  $O'$ .

$$\begin{aligned} b'_k &= \varepsilon_k \oplus \overline{Q}_{k-1} = \overline{b}_k \Rightarrow \text{error} \\ b'_{k+1} &= Q_{k+1} \oplus \varepsilon_k = \overline{b}_{k+1} \Rightarrow \text{error} \\ b'_{k+2} &= E'_{k+2} \oplus Q'_{k+1} = b_{k+2} \Rightarrow \text{correct} \end{aligned}$$

Next is the case of two symbol detection errors occurring consecutively on  $E'$  and  $O'$ , i.e., detectors emit error symbols  $E'_{k} = \varepsilon_k$  and  $O'_{k+1} = \varepsilon_{k+1}$ . Starting again with equation [B-4a](#) yields:

$$\begin{aligned} b'_k &= \varepsilon_k \oplus \overline{Q}_{(k-1)} = \overline{b}_k \Rightarrow \text{error} \\ b'_{(k+1)} &= \varepsilon_{(k+1)} \oplus \varepsilon_k = O'_{(k+1)} \oplus E_k = b_{(k+1)} \Rightarrow \text{correct} \\ b'_{(k+2)} &= E'_{(k+2)} \oplus \varepsilon_{(k+1)} = b_{(k+2)} \Rightarrow \text{error} \\ b'_{(k+3)} &= O'_{(k+3)} \oplus E'_{(k+2)} = b_{(k+3)} \Rightarrow \text{correct} \end{aligned}$$

Two consecutive symbol errors produce two decoding errors but the errors are not adjacent. The conclusion from this is that symbol detection errors influence no more than two decoding cycles, i.e., the maximum error multiplication factor is 2.

## B.7. Recursive Processing and Code Memory

Most systems reconstruct the original bit rate clock and  $\{b\}$  by merging  $\{e'\}$  and  $\{o'\}$ . For a variety of reasons, designers might be tempted to multiplex  $\{I'\}$  and  $\{Q'\}$  into a bit rate code symbol sequence  $\{B_n\}$  prior to decoding; however, the same considerations that foster desire for post-multiplex decoding are likely to be accompanied by loss of transmitted code

symbol order, i.e., loss of knowledge whether a given code symbol came from  $I$  or  $Q$ . The question arises as to whether  $\{B_n\}$  alone contains enough information for unique decoding. The answer is no, and the proof is shown below.

Proof:

A decoding function can be derived by inspection of equations [B-5](#) and [B-6](#). Equation [B-5](#) can be rearranged as follows:

$$I_k = e_k \oplus o_{k-1} \oplus \bar{I}_{k-2} \quad \text{B-7}$$

Similarly, from equation [B-6](#) we can write

$$Q_{k+1} = o_{k+1} \oplus e_k \oplus \bar{Q}_{k-1} \quad \text{B-8}$$

Here are two instances of a seemingly identical recursive relationship, i.e., the current code symbol is the difference between the current bit, the previous bit, and the inverse of the most recent code symbol from the current channel. We can consolidate these equations by converting to post-multiplex bit rate indexing, i.e.,

$$B_n = b_n \oplus b_{(n-1)} \oplus \bar{B}_{n-2} \quad \text{B-9}$$

from which we can immediately write the decoding function

$$b'_n = b'_{(n-1)} \oplus B'_n \oplus \bar{B}'_{(n-2)} \quad \text{B-10}$$

On the surface it seems that Equation [B-10](#) will work;<sup>42</sup> however, these relations involve two differences, rather than one, and therefore introduce superfluous initial condition dependence. For brevity, only the pitfalls of [B-10](#) are examined herein, assuming that a non-recursive encoder is used. From startup, decoding will progress as follows.

$$\begin{aligned} \|b'_0\| &= \langle b'_{-1} \rangle \oplus B'_0 \oplus \langle \bar{B}'_{-2} \rangle \\ \|b'_1\| &= \|b'_0\| \oplus B'_1 \oplus \langle \bar{B}'_{-1} \rangle \\ \|b'_2\| &= \|b'_1\| \oplus B'_2 \oplus \bar{B}'_0 \\ \|b'_3\| &= \|b'_2\| \oplus B'_3 \oplus \bar{B}'_1 \\ &\vdots \\ &\vdots \\ &\vdots \end{aligned}$$

As seen, absolute polarity of the first and all subsequent decoded bits is determined by three initial values. Absent appropriate side information for selecting initial values, the post-multiplex decoder offers a 50-50 chance of decoding with correct polarity. The code sequence defined by equations at [B-3](#) has a two-symbol memory. Additional symbols do not provide new information regarding the trajectory history. Another way to view this problem is to note that this

<sup>42</sup> The interested reader is left to confirm that equation C-10 is indeed rotation invariant.

recursive decoder does not guarantee preservation of symbol order, which is a prerequisite to reliable decoding.

### B.8. Frequency Impulse Sequence Mapping for SOQPSK

The SOQPSKs first described by Hill<sup>43</sup> and Geoghegan<sup>44</sup> are defined as special cases of CPM. Since 1998, at least two manufacturers have exploited the fact that modern digital waveform synthesis techniques enable direct implementation of the CPM equations with virtually ideal frequency modulators and filter impulse responses. A generic model of these implementations is in [Figure B-6](#). The I and Q channels, per se, do not exist in this transmitter. At the beginning of each bit interval, impulses from the bit-to-impulse alphabet mapper direct the impulse filter/frequency modulator to advance the carrier phase by 90°, retard it by or 90°, or leave the phase unchanged. This is accomplished with a ternary alphabet of frequency impulses having normalized amplitudes of  $\{-1,0,1\}$ .<sup>45</sup> This structure cannot be mapped directly into the constellation convention of a quadriphase implementation because there is no way to control absolute phase. The equations at [B-3](#) can be applied to this non-quadrature architecture via pre-coding. A general treatment SOQPSK pre-coding is contained in Simon.<sup>46</sup> The pre-coding truth table given in [Table B-3](#) applied to the model in [Figure B-7](#) will yield a phase trajectory history identical to one generated by the quadriphase counterpart of [Figure B-2](#) using the equations at [B-3](#); however, one more constraint is necessary to establish compatibility with the IRIG-106 quadriphase convention. [Table B-3](#) assumes the stipulation that positive sign impulse values will cause the modulator to increase carrier frequency.

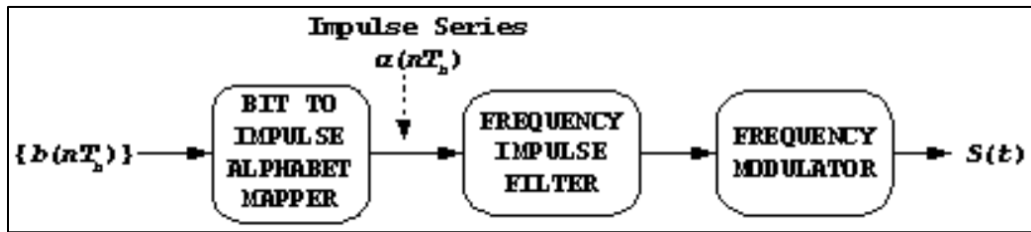

Figure B-6. SOQPSK Transmitter

Table B-3. SOQPSK Pre-Coding Table for IRIG-106 Compatibility									
MAP $\alpha_k$ FROM $I_k$					MAP $\alpha_{k+1}$ FROM $Q_{k+1}$				
$I_k$	$Q_{k-1}$	$I_{k-2}$	$\Delta\Phi$	$\alpha_k$	$Q_{k+1}$	$I_k$	$Q_{k-1}$	$\Delta\Phi$	$\alpha_{k+1}$
-1	X*	-1	0	0	-1	X*	-1	0	0
+1	X*	+1	0	0	+1	X*	+1	0	0
-1	-1	+1	$-\pi/2$	-1	-1	-1	+1	$+\pi/2$	+1
-1	+1	+1	$+\pi/2$	+1	-1	+1	+1	$-\pi/2$	-1
+1	-1	-1	$+\pi/2$	+1	+1	-1	-1	$-\pi/2$	-1

<sup>43</sup> Hill, “An Enhanced, Constant Envelope, Interoperable Shaped Offset QPSK.”

<sup>44</sup> Geoghegan, “Implementation and Performance Results.”

<sup>45</sup> The so-called ternary alphabet is actually 2 binary alphabets  $\{-1,0\}$  and  $\{0,1\}$ , the appropriate one chosen on a bit-by-bit basis according to certain state transition rules.

<sup>46</sup> Marvin Simon. “Multiple-Bit Differential Detection of Offset Quadriphase Modulations.” IPN Progress Report 42-151. 15 November 2002. Jet Propulsion Laboratory, Pasadena, CA. Retrieved 17 May 2021. Available at [http://ipnpr.jpl.nasa.gov/progress\\_report/42-151/151A.pdf](http://ipnpr.jpl.nasa.gov/progress_report/42-151/151A.pdf).

+1	+1	-1	$-\pi/2$	-1	+1	+1	-1	$+\pi/2$	+1
* Note: Does not matter if “X” is a +1 or a -1									

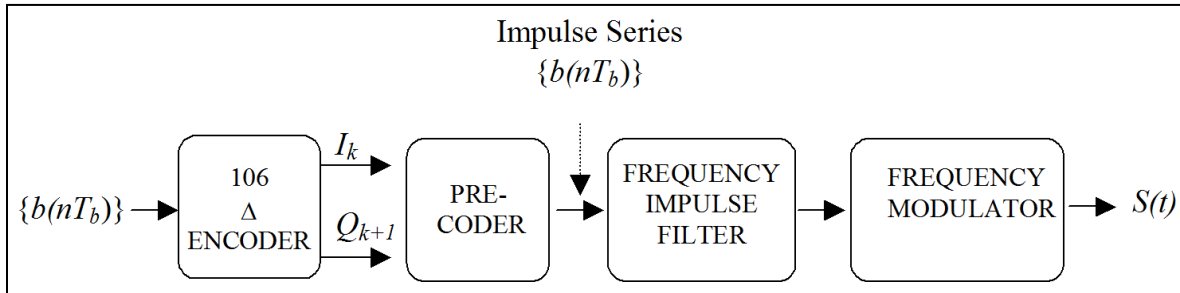

Figure B-7. OQPSK Transmitter (With Precoder)

## B.9. Summary

This investigation confirmed that the differential encoder defined in the equations at [B-3](#) is entirely satisfactory for SOQPSK, FQPSK-JR, and FQPSK-B systems where conventional coherent demodulation and single-symbol detection is used. In addition, a method of extending this code to SOQPSK is presented without proof.

Specifically, the following has been shown.

- When accompanied by consistent sign conventions, a consistent symbol-to-phase mapping rule, and preservation of symbol order, the OQPSK differential code defined in [B-3](#) and the decoding rule defined in [B-4](#) is rotation invariant and unambiguously reconstructs the original data bit sequence.
- Decoding is instantaneous.
- Equations [B-3](#) and [B-4](#) do not require attention to initial values.
- At most, two consecutive output bits will be in error after carrier and symbol synchronization is acquired.
- The recursive relations in equations [B-9](#) and [B-10](#) are ambiguous and therefore unreliable.
- The code exhibits a detection error multiplication factor of at most two.

## B.10. System-Level Software Reference Implementation of Differential Encoder Defined in IRIG Standard 106 for FQPSK and SOQPSK Modulations

### B.10.a. Introduction

The Matlab®™ program listings below provide a Matlab function “Desysdemo” and an execution control script “runDEdemo”. In the context of differential encoding, the function provides a complete system simulation including a differential encoder, an ideal vector modulator, channel phase rotation, demodulation, the functional equivalent of an ideal single-symbol sample and hold detector, and a decoder. The user can create sample data vectors or use the example data provided. In addition, the user can manipulate the initial value vectors to explore all possible initial value and demodulator phase rotation combinations of the quadriphase implementation model.



By setting the variable “style” to zero, the function will also emulate the pre-coded frequency modulator architecture required for SOQPSKs; however, the initial value of transmitter carrier phase is hard-coded at  $45^\circ$ . This was done to avoid proliferation of initial value options and is thought to be an insignificant omission because it does not affect generality of the phase rotation options.

This material assumes that the user is familiar with Matlab workspace operation. The program relies only on basic Matlab license libraries. No special toolboxes or blocksets are required.

#### B.10.b. Matlab Workspace Operation

The user should place the script (shown below in Section [B.10.c](#)) in the directory of choice and make that directory current in the workspace. In order to execute the canned example, the user needs to create the variable “example” in the workspace and set its value to 1.

Executing the script “runDEdemo” should produce the output displayed in [Table B-4](#).

<b>Table B-4. Script “runDEdemo” Output</b>				
results =				
Model: Quadriphase Vector Modulator				
Demodulator Phase Rotation = $0^\circ$				
Initial States:	Encoder Memory	Encoder Channel	Decoder Memory	Decoder Channel
	(0,0)	0	(0,0)	0
Input Bit	TX Phase	RX Phase	Output Bit	Decoding Error
1	225	225	1	0
1	135	135	1	0
1	45	45	1	0
0	45	45	0	0
0	135	135	0	0
1	135	135	1	0
0	135	135	0	0
1	135	135	1	0
1	45	45	1	0
1	315	315	1	0
0	315	315	0	0
0	45	45	0	0
1	45	45	1	0
0	45	45	0	0

The first column of the results shown above is a replica of the input data vector. The second column shows the initial value-dependent evolution of transmitted phase. The third column shows the effect of any non-zero phase rotation chosen. The fourth column shows the decoded output bit stream. The fifth column flags decoding errors with values of 1. Certain combinations of phase rotation and initial values will produce values of 9 in the fourth and fifth

columns; results of this nature are associated with cases that delay the output decoding process by one bit.

Variable definitions and implied instructions for manipulating the runtime options can be obtained by using the normal Matlab help command for these specific programs.

#### B.10.c. Script for Modules

Electronic copies of these programs have been provided to the RCC Telemetry Group. The script for the modules discussed above is shown on the following pages.

```

% Control Script 'runDEdemo', for running system demonstration
% of differential encoder and phase mapping convention
% defined in RCC standard IRIG-106 for FQPSK-B modulation.
% This version extends demonstration options to the pre-coder
% required for implementing SOQPSK with frequency modulators.
%
% Each example run requires input variables in the Matlab workspace:
%
% "example" - a flag to run with user supplied data vector or run
% the example data set that consists of two repetitions of a
% a 7-bit pseudo random sequence(0=user, 1=example)
% "data" - optional user supplied binary bit sequence (arbitrary
length)
% "rotation_choice" - pointer to demodulator phase rotation options:
% 1=0, 2=pi/2, 3= pi, 4=3*pi/2
% "initTX" - vector of binary encoder startup values:
% initTX(1)= 1st of two encoder code symbol memory values(binary,
arbitrary)
% initTX(2)= 2nd encoder code symbol memory value(binary, arbitrary)
% initTX(3)= starting channel for encoder(binary, 0=I, 1=Q)
% "initRX" - vector of binary decoding startup values
% initRX(1)= 1st of two decoder state memory values(binary, arbitrary)
% initRX(2)= 2nd decoder state memory value(binary, arbitrary)
% initRX(3)= starting channel for decoder(binary, 0=I, 1=Q)
% "style" - 1=quadrature transmitter architecture (FQPSK)
% 0=frequency modulator transmitter architecture (SOQPSK)
% The example values are:
% data=[1 1 1 0 0 1 0 1 1 1 0 0 1 0]
% rotation_choice=1
% initTX=[0 0 0]
% initRX=[0 0 0]
% style=1

% R.P.Jefferis, TYBRIN Corp., JULY, 2002
% SOQPSK model added 14JUL03
% This version has been tested with Matlab versions:5.2,6.1

% *** Sample Input Setup ***
if example
    data=[1 1 1 0 0 1 0 1 1 1 0 0 1 0];
    rotation_choice=1;
    initTX=[0 0 0];
    initRX=[0 0 0];
    style=1;
end

% *** Run the Reference Implementation ***

[test,delay]=DEsysdemo(data,rotation_choice,initTX,initRX,style);

% *** Prepare Screen Output ***

```

```

ROTATION=[0 90 180 270];
if style
    results=sprintf('Model: Quadriphase Vector Modulator\n')
else
    results=sprintf('Model: Frequency modulator (SOQPSK) model\n')
end
results=[results sprintf('Demodulator Phase Rotation = %3.0f
degrees\n',ROTATION(rotation_choice))];
results=[results sprintf('Initial States: Encoder Encoder Decoder
Decoder\n')];
results=[results sprintf('
Memory Channel Memory
Channel\n')];
results=[results sprintf('-----
----\n')];
results=[results sprintf('
(%d,%d) %d (%d,%d)
%d\n\n',...
    initTX(1:2),initTX(3),initRX(1:2),initRX(3))];
results=[results sprintf(' Input TX RX Output Decoding\n')];
results=[results sprintf(' Bit Phase Phase Bit Error\n')];
results=[results sprintf('-----\n')];
for n=1:length(data)
    results=[results sprintf(' %d %3.0f %3.0f %d
%d\n',...
        test(n,:))];
end
results

% _____ END OF CONTROL SCRIPT _____

function [result,delay]=
DEsystemdemo(inbits,rotation_choice,initTX,initRX,style)
% Reference simulation for Range Commanders Council standard IRIG 106-
2000
% FQPSK-B differential encoding and phase mapping convention.
%
% Input arguments: see "help" for "runDEdemo" script
% Output arguments:
% "result" - Mx5 matrix,M=number of input bits,columns contain:
% (:,1)input bit,(:,2)TX phase,(:,3)RX phase,(:,4)output
bit,(:,5)status
% "delay" - overall encode/decode process delay in bits

% "TX" prefixes refer to transmitter/encoder variables, "RX" prefixes
% refer to receiver/decoder variables
% Robert P. Jefferis, TYBRIN Corp., July,2002.
% SOQPSK model added 14JUL03
% This version has been tested with Matlab versions: 5.2,6.1
numbits=length(inbits)

% *****
% * Transmitter *
% *****

```

```

% *** differential encoder (also SQPSK pre-coder)****

% encoder memory initial values:
% [(last I ch. code symbol) (last Q ch. code symbol)]
TXlastSYM=initTX(1:2);
% point encoder to either I or Q starting channel(0=I)
TXpoint=initTX(3);
for n=1:numbits
    switch TXpoint
        case 0
            %TXlastSYM
            % compute "current" I channel code symbol
            TXnewISYM=xor(inbits(n),~TXlastSYM(2));
            TXcodeSYM(n,:)= [TXnewISYM TXlastSYM(2)]; % new phase
coordinates(I,Q)
            TXlastSYM(1)=TXnewISYM; % update encoder memory state
            TXpoint = ~TXpoint; % point to Q channel eq. for next bit
        case 1
            % compute "current" Q channel code symbol
            TXnewQSYM=xor(inbits(n),TXlastSYM(1));
            TXcodeSYM(n,:)= [TXlastSYM(1) TXnewQSYM]; % new phase
coordinates(I,Q)
            TXlastSYM(2)=TXnewQSYM;% update encoder memory state
            TXpoint= ~TXpoint; % point to I channel eq. for next bit
        otherwise
            disp('Invalid Specification of Encoder starting channel');
    end
end
end

% *** modulate ***

switch style
case 1 % ** Quadriphase vector modulator **

    % RCC IRIG 106 FQPSK-B phase mapping convention: (I,Q)
    for n=1:numbits
        index=floor(2*TXcodeSYM(n,1)+TXcodeSYM(n,2));
        switch index
            case 3 % [1 1]
                TXphase(n)=45; % TX phase angle, degrees
            case 1 % [0 1]
                TXphase(n)=135;
            case 0 % [0 0]
                TXphase(n)=225;
            case 2 % [1 0]
                TXphase(n)=315;
            otherwise, disp('map error')
        end
    end
end
case 0 % ** Frequency modulator w/pre-coder **

```

```

% * pre-coder *
% map code symbol sequence to frequency impulse series, alpha(n)
alpha=zeros(1,numbits);
TXpoint=initTX(3); % in this mode, points to start index
for n=3:numbits
    if TXpoint % Q(k+1) map
        if TXcodeSYM(n,2)==TXcodeSYM(n-2,2)
            elseif xor(TXcodeSYM(n,2),TXcodeSYM(n-1,1))
                alpha(n)=-1;
            else
                alpha(n)=1;
            end
        else % I(k) map
            if TXcodeSYM(n,1)==TXcodeSYM(n-2,1)
                elseif xor(TXcodeSYM(n,1),TXcodeSYM(n-1,2))
                    alpha(n)=1;
                else
                    alpha(n)=-1;
                end
            end
        TXpoint=~TXpoint; % switch to complement function for next bit
    end

% convert alpha to phase trajectory
lastTXphase=45; % initial phase of S(t)
for n=1:numbits
    TXphase(n)=mod(lastTXphase+alpha(n)*90,360);
    lastTXphase=TXphase(n);
end
otherwise
end

% *****
% * Receiver *
% *****

% *** Demodulator Phase Rotation ***
ROTATE=[0 pi/2 pi 3*pi/2];
rotate=ROTATE(rotation_choice);
for n=1:numbits
    switch rotate
        case 0
            RXphase(n)=TXphase(n);
        case pi/2
            RXphase(n)=mod(TXphase(n)+90,360);
        case pi
            RXphase(n)=mod(TXphase(n)+180,360);
        case 3*pi/2
            RXphase(n)=mod(TXphase(n)+270,360);
        otherwise
            end
end
end

```

```

% *** detector ***
for n=1:numbits
    switch RXphase(n)
    case 45
        RXcodeSYM(n,:)=[1 1];
    case 135
        RXcodeSYM(n,:)=[0 1];
    case 225
        RXcodeSYM(n,:)=[0 0];
    case 315
        RXcodeSYM(n,:)=[1 0];
    otherwise
    end
end

% *** decode and reconstruct data bit sequence ***

% decoder memory initial values:
% [(last decoded I channel bit) (last decoded Q channel bit)]
RXlastSYM=initRX(1:2);
% point decoder channel to either I or Q starting channel (0=I)
RXpoint=initRX(3);
for n=1:numbits
    switch RXpoint
    case 0
        % compute "current" decoded I channel bit
        RXbits(n)=xor(RXcodeSYM(n,1),~RXlastSYM(2));
        RXlastSYM=RXcodeSYM(n,:); % update decoder state
        RXpoint = ~RXpoint; % point to Q channel eq. for next bit
    case 1
        % compute "current" decoded Q channel bit
        RXbits(n)=xor(RXcodeSYM(n,2),RXlastSYM(1));
        RXlastSYM=RXcodeSYM(n,:); % update decoder state
        RXpoint= ~RXpoint; % point to I channel eq. for next bit

    otherwise
    end
end

% _____ END OF TX and RX Processing _____

% *****
% * Assemble Output *
% *****

% identify delay incurred in overall process
offset=xcorr(inbits,RXbits);
offset(1:numbits-1)=[];
[offset,delay]=max(offset(1:min(length(offset),10)));
delay=delay-1;

```

```

% adjust RX output bit vector to compensate for delay,
% inserting values of 9 at beginning of vector to represent
% artifact bits associated with asymmetric rotation cases
checkbits=inbits;
if delay
    newfront=ones(1,delay)*9;
    checkbits=[newfront inbits];
    checkbits(end-delay+1:end)=[];
    RXbits(1:delay)=9;
end
% identify decoding errors in reconstructed bit stream
xmsn_error=checkbits~=RXbits;
xmsn_error(1:delay)=9;
% assemble output matrix
result(:,1)=inbits';
result(:,2)=TXphase';
result(:,3)=RXphase';
result(:,4)=RXbits';
result(:,5)=xmsn_error';

% _____END OF FUNCTION DEsysdemo_____

```



## APPENDIX 2-C

**Telemetry Transmitter Command and Control Protocol****C.1. Introduction**

This appendix provides standards for commands, queries, and status information when communicating with telemetry transmitters configured with communication ports. The commands are divided into two categories of command sets as follows.

- a. Basic. The basic command set contains the minimum (required) commands for transmitter control, query, and status.
- b. Extended. The extended command set contains optional commands that may or may not be implemented and may be shown as references.

**C.2. Command Line Interface****C.2.a. User Command Line Interface**

This interface is the default upon power up of the transmitter. Each command or query is ended by a carriage return <CR>. Information returned from the transmitter will be followed by a carriage return <CR> and the “>” will be displayed to indicate the transmitter is ready to receive commands or queries.

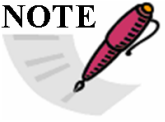
 <p><b>NOTE</b></p>	<p>With regard to this standard, it is assumed that a carriage return &lt;CR&gt; is followed by a line feed. The transmitter will return the “OK” mnemonic for each command that is accepted. The transmitter will return “ERR” for a command or query that was interpreted as an error. Verification that a query was either accepted or found to be in error will be the response to the query. All commands are case-insensitive. The transmitter will operate in half-duplex mode and will echo typed characters to the command terminal.</p>
--	---

In addition to the required user command line interface items, the following list contains options that may or may not be implemented.

- a. Backspacing to correct typed errors.
- b. A character input to recall the last command line. The “^” character followed by a <CR> is recommended.

**C.2.b. Optional Programming Interface**

If the transmitter is not commanded or queried through a terminal program (human interface), there may be an option to operate in half-duplex mode so that concatenated commands can be sent directly to the transmitter (bulk transmitter set-up). If this option is used, the transmitter will only return a single accepted “OK” response if the entire string was interpreted and accepted. When concatenating commands, the semicolon is used as the delimiter for each command. If this optional programming interface is implemented, the transmitter will identify the semicolon delimiter, recognize the character string as a bulk command, and recognize the start of a new command after each delimiter.

### C.3. Initialization

Upon successful communication initialization, the transmitter will provide the controlling terminal with (as a minimum) the manufacturer's name, model number, serial number, and supported IRIG-106 release number. Other information (such as information on firmware and temperature) deemed appropriate by the manufacturer is allowed. This information will be displayed only upon a successful power up and communication initialization of the transmitter. Should an unsuccessful power up occur, based upon criteria of the transmitter manufacturer, the transmitter shall return "ERR" and allow only the RE(RES) command to reset the transmitter (see Subsection [C.4.b\(9\)](#)).

Upon successful communication, after a power up, a communication connection, a command, or a query, the transmitter will send a carriage return followed by a ">" to signify the transmitter is ready to accept commands and queries.

### C.4. Basic Command Set

#### C.4.a. Basic Command Set Summary

The basic command fields use a minimum two characters with the optional capability of using a maximum of four characters. If possible, the longer four-character field should be used to add intuitiveness to the basic command set. The commands in the basic command set are shown in [Table C-1](#).

<b>Table C-1. Basic Command Set</b>	
<b>Command</b>	<b>Function</b>
FR(FREQ)	Sets or queries the carrier frequency.
MO(MOD)	Sets or queries the modulation mode.
RA(RAND)	Sets or queries the setting of data randomization (ON or OFF).
RF	Sets or queries the RF output (ON or OFF).
QA(QALL)	Queries the status of all basic commands.
VE(VERS)	Queries, at a minimum, the manufacturer's name, model number, and serial number of the transmitter.
SV(SAVE)	Saves the current set-up of the transmitter to on-board nonvolatile random access memory (RAM).
RL(RCLL)	Retrieves a transmitter set-up from on-board nonvolatile RAM.
RE(RES)	Resets the transmitter to a known configuration or restarts the internal power-up sequence.
DS(DSRC)	Sets or queries the data source (INT or EXT).
CS(CLKS)	Sets or queries the clock source (INT or EXT).
ID(IDP)	Sets or queries the internal data pattern (one of five possible settings).
IC(ICR)	Sets or queries the internal clock rate.
TE(TEMP)	Queries the internal temperature (in Celsius).
FC(FEC)	Sets or queries FEC.
ST(STC)	Sets or queries Space Time Coding.

C.4.b. Commands: Basic Command Set

C.4.b(1) Carrier Frequency

Carrier frequency is set or queried with the FR(FREQ) mnemonic as described below.

- a. Set Frequency. Use “FR(FREQ) XXXX.X <CR>” where XXXX.X is the commanded frequency in MHz in 0.5-MHz steps. If the command is accepted, an “OK <CR>” is issued as a response.

In the event of an incorrect commanded carrier frequency (for example the commanded frequency is out of the tuning range of the transmitter), the transmitter will default to the currently set carrier frequency before the command was issued. The transmitter will then return “ERR FR(FREQ) XXXX.X <CR>” where XXXX.X is the prior frequency set in the transmitter.

- b. Query Frequency. “FR(FREQ) <CR>” queries the currently set carrier frequency and returns “FR(FREQ) XXXX.X <CR>” where XXXX.X is the current set frequency in MHz.

C.4.b(2) Modulation Mode

Modulation mode is set or queried with the MO(MOD) mnemonic.

- a. Set Modulation Mode. Use “MO(MOD) X <CR>” where X corresponds to the modulation mode. If the command is accepted, an “OK <CR>” is issued as a response.

Command	Modulation Type
MO(MOD) 0	PCM/FM
MO(MOD) 1	SOQPSK-TG
MO(MOD) 2	ARTM-CPM
MO(MOD) 6	Modulation off (carrier only)

In the event of an incorrect commanded modulation mode, the transmitter will default to the previous modulation mode and return “ERR MO(MOD) X <CR>” to indicate the error and the current modulation mode. The “MO(MOD) 6” command turns off the modulation for carrier-only mode. Modulation will return upon a new commanded modulation mode. If the transmitter is in single mode, only single mode commands are valid and the above error response will be sent should an invalid modulation mode command be sent. The same logic applies when the transmitter is in dual mode.

- b. Query Modulation Mode. “MO(MOD) <CR>” queries the currently set modulation mode and returns “MO(MOD) X <CR>” where the integer X is represented in the above table.

C.4.b(3) Data Randomization

Data randomization is set or queried with the RA(RAND) mnemonic. For additional information on randomization, see Subsection [2.3.3.5](#). This command only enables/disables the randomizer specified in [Annex A.2](#), Figure A.2-2.

- a. Set Data Randomization. Use “RA(RAND) X <CR>” where X corresponds to a 1 or 0. If the command is accepted, an “OK <CR>” is issued as a response.

Command	Randomization
RA(RAND) 1	On
RA(RAND) 0	Off

	<p><b>NOTE</b> When FEC is enabled, randomization per Section <a href="#">D.6</a> should be implemented. If RA(RAND) was enabled prior to enabling FEC, it will be disabled when FEC is enabled. The default state for RA(RAND) will be off when FEC is enabled.</p>
---	--

In the event of an incorrect data randomization command, the transmitter will default to its current setting and return “ERR RA(RAND) X <CR>” to indicate the error and the currently set state. If FC(FEC) is enabled, a “RA(RAND) 1” command will return an ERR RA(RAND) 1<CR>.

- b. Query Randomization Mode. “RA(RAND) <CR>” queries the currently set randomization and returns “RA(RAND) X <CR>” where integer X is represented in the above table.

C.4.b(4) RF Output

The RF output is set or queried with the RF mnemonic.

- a. Set RF Output. Use “RF X <CR>” where X corresponds to a 1 or 0. If the command is accepted, an “OK <CR>” is issued as a response.

Command	RF Output
RF 1	On
RF 0	Off

In the event of an incorrect RF output command, the transmitter will maintain its current state and return “ERR RF X <CR>” to indicate the error and return the current RF output setting for the transmitter.

- b. Query RF Output. “RF <CR>” queries the currently set RF output and returns “RF X <CR>” where X corresponds to the numbers in the above table.

C.4.b(5) Query All

The “query all” command is executed with the QA(QALL) mnemonic.

- a. Query Transmitter Configuration. The command “QA(QALL) <CR>” requests the current setting of all basic commands. The transmitter response will contain, as a minimum, the following, in this order:

- (1) Carrier Frequency. [FR(FREQ) XXXX.X]<CR>
- (2) Modulation Mode. [MO(MOD) X] <CR>
- (3) Randomization setting. [RA(RAND) X] <CR>
- (4) RF Output setting. [RF X] <CR> OK<CR>
- (5) Data Source. [DS(DSRC) X] <CR>
- (6) Internal Data Pattern [ID(IDP) X] <CR>
- (7) Clock Source [CS(CLKS) X] <CR>
- (8) Internal Clock Rate [IC(ICR) XX.XXX] <CR>

- (9) Internal Temperature [TE(TEMP) XXX] <CR>
- (10) Forward Error Correction [FC(FEC) X] <CR>
- (11) Space Time Coding [ST(STC) X] <CR>

- b. Status of Other Commands. If other commands are implemented in the transmitter beyond the basic set, a complete status should be given for each implemented command.

#### C.4.b(6) Version

The “version” command is executed with the VE(VERS) <CR> mnemonic.

- a. Query Transmitter Version. “VE(VERS) <CR>” requests the current version of the transmitter. The response will contain (at a minimum) the following information about the transmitter and in this order:

- (1) Manufacturer Name
- (2) Model Number
- (3) Serial Number

- b. Formatting and Delimiting the Fields. It is left up to the transmitter manufacturer to format and delimit the above fields and, if chosen, add additional information to the response.

#### C.4.b(7) Save

The “save” command is executed with the SV(SAVE) mnemonic.

For “Save Transmitter Set-Up”, “SV(SAVE) X<CR>” saves the current settings of the transmitter to register “X” in nonvolatile memory within the transmitter. If only one location is available, the value of “X” is zero. This document puts no limit to the number of storage registers as this is limited by available nonvolatile memory.

The command “SV(SAVE) <CR>” will save to the default location 0.

In the event of an unsuccessful save command, the transmitter will return ERR SV(SAVE) X<CR> to indicate the error and no save function will be performed.

In order to avoid the situation of fielding a flight test item that has been inadvertently programmed to use internal clock and data sources, the transmitter power up configuration will always have the clock and data source as external. In addition, when saving to register “0” clock and data sources will always be set to external.

#### C.4.b(8) Recall

The recall command is executed with the RL(RCLL) mnemonic.

For “Recall Transmitter Set-up”, “RL(RCLL) X<CR>” retrieves and restores the transmitter set-up from register “X” in nonvolatile memory within the transmitter. Values of X start at zero. The “0” register location should be used exclusively for the default set-up, which is the memory location that is loaded during power-up.

The command “RL(RCLL) <CR>” will recall from the default register location “0”.

In the event of an unsuccessful recall command, the transmitter will return ERR RL(RCLL) X<CR> to indicate the error and no recall function will be performed.

During a recall operation the transmitter will always set the clock and data sources to external (see Subsection [C.4.b\(7\)](#)).

C.4.b(9) Reset

The transmitter can be reset with the RE(RES) mnemonic.

- a. Reset Transmitter. “RE(RES) <CR>” resets the transmitter by reinitializing the transmitter. The transmitter will use the following basic settings as a base configuration.

Transmitter Setting	Command	Result
Carrier frequency	[FR(FREQ)]	Lowest valid frequency within the tuning range
Modulation mode	[MO(MOD)]	MO(MOD) 0, PCM/FM
Differential encoding	[DE X]	DE 0, Differential encoding off
Randomization	[RA(RAND) X]	RA(RAND) 0, Randomization off
RF output	[RF X]	RF 0, RF output off
Data source	[DS(DSRC)]	DS(DSRC) 0 External
Clock source	[CS(CLKS)]	CS(CLKS) 0 External
Internal Data Pattern	[ID(IDP)] 11	[ID(IDP)] 11 PN11 ( 2 <sup>11</sup> -1)
Internal Clock Rate	[IC(ICR)]	IC(ICR) 05.000 5 MHz
Forward Error Correction	[FC(FEC)]	FC(FEC) 0, Forward Error Correction is off
Space Time Coding	[ST(STC)]	ST(STC) 1, Space Time Coding is on

- b. Example Command Use. The Reset command would be used if resetting to a known configuration is required, communication to the transmitter could not be established, if commands were not being recognized, or if some other unknown transmitter state was experienced.

C.4.b(10) Data Source

Data source is set or queried with the DS(DSRC) mnemonic.

- a. Set Data Source. Use “DS(DSRC) X <CR>” where X corresponds to a 1 or 0. If the command is accepted, an “OK <CR>” is issued as a response.

Command	Source
DS(DSRC) 0	External
DS(DSRC) 1	Internal

In the event of an incorrect data source command, the transmitter will return “ERR DS(DSRC) X <CR>” to indicate the error and return the currently set data source state.

- b. Query Data Source. “DS(DSRC) <CR>” queries the currently set data source and returns “DS(DSRC) X <CR>” where integer X is represented in the above table.
- c. Saving Data Source. See Subsection [C.4.b\(7\)](#) regarding saving the data source setting.

C.4.b(11) Clock Source

The clock source is set or queried with the CS(CLKS) mnemonic.

- a. Set Clock Source. Use “CS(CLKS) X <CR>” where X corresponds to a 1 or 0. If the command is accepted, an “OK <CR>” is issued as a response.

Command	Source
CS(CLKS) 0	External
CS(CLKS) 1	Internal

In the event of an incorrect command, the transmitter will return “ERR CS(CLKS) X <CR>” to indicate the error and the current clock source setting for the transmitter.

- b. Query Clock Source. “CS(CLKS) <CR>” queries the currently set clock source and returns “CS(CLKS) X <CR>” where integer X is represented in the above table.
- c. Example Command Use. Internal data can be clocked either with an external or internal clock. This command allows the user to clock the known data with an existing external clock or select the internal clock for more flexibility.
- d. Saving Clock Source. See Subsection [C.4.b\(7\)](#) regarding saving the clock source setting.

C.4.b(12) Internal Data Pattern

The internal data pattern is set or queried with the ID(IDP) mnemonic.

- a. Set Internal Data Pattern. Use “ID(IDP) X” where X corresponds to the internal data pattern. If the command is accepted, an “OK <CR>” is issued as a response.
- b. Example Internal Data Patterns. Example patterns are shown below.

Command	Pattern	
ID(IDP) 9	$2^9-1$	(511 bits)
ID(IDP) 11	$2^{11}-1$	(2047 bits)
ID(IDP) 15	$2^{15}-1$	(32767 bits)
ID(IDP) 20	$2^{20}-1$	(1048575 bits)
ID(IDP) 23	$2^{23}-1$	(8388607 bits)
ID(IDP) 0000	0x0000	Fixed repeating
ID(IDP) FFFF	0xFFFF	Fixed repeating
ID(IDP) AAAA	0101010	Fixed repeating
ID(IDP) XXXX	0xXXXX	Fixed repeating

The minimum supported patterns shall be PN11, PN15, and AAAA. Selection of which additional patterns to implement is left up to the manufacturer. If an error occurs, the transmitter will return “ERR ID(IDP) X <CR>” to indicate the error and return the current data source setting for the transmitter.

- c. Query Internal Data Pattern. “ID(IDP) <CR>” queries the currently set internal data pattern and returns “ID(IDP) X <CR>” where integer X is represented in the above table.
- d. Example Command Use. This feature can be used for system characterization and troubleshooting. A known bit pattern can be used to test and characterize telemetry systems end-to-end or isolate baseband signal problems to the transmitter.

C.4.b(13) Internal Clock Rate

The internal clock rate is set or queried with the IC(ICR) mnemonic.

- a. Set Internal Clock Rate. Use “IC(ICR) XX.XXX <CR>” where XX.XXX corresponds to the clock frequency in MHz and is used to clock the selected internal data pattern. See Subsection [C.4.b\(12\)](#). Actual range for the clock frequency is left to the manufacturer but should correspond to the specified useable input clock frequency range. Resolution should be ±1 kHz. Accuracy for the internal clock is left to the manufacturer but should correspond to internal values for the transmitter. If the command is accepted, an “OK <CR>” is issued as a response.

In the event of an incorrect command, the transmitter will identify the error, default to its current state, and return “ERR IC(ICR) XX.XXX <CR>” where “XX.XXX” indicates the current clock source for the transmitter.

- b. Query Internal Clock Rate. “IC(ICR) <CR>” queries the currently set internal clock rate and returns “IC(ICR) XX.XXX” where XX.XXX is the current set internal clock rate in MHz.

C.4.b(14) Internal Temperature

Internal temperature is only a query with the TE(TEMP) mnemonic.

Using TE(TEMP) will query the current internal temperature of the transmitter and returns “TE(TEMP) XXX” where XXX is the temperature in Celsius.

C.4.b(15) Forward Error Correction

When used, FEC is set or queried with the FC(FEC) mnemonic. If FEC per [Appendix 2-D](#) is implemented in the transmitter, this command will enable, disable, or query the current setting.

- a. Set Forward Error Correction. Use “FC(FEC) X <CR>” where X corresponds to the table below. If X=1, then the command structure is “FC(FEC) 1 xxxx yy <CR>” where xxxx corresponds to the block size and yy corresponds to the code rate. If the command is accepted, an “OK <CR>” is issued as a response. When FC(FEC) is enabled, randomization in the transmitter [RA(RAND)] shall be disabled.

Command	Source	Block Size	Code Rate
FC(FEC) 0	Disable		
FC(FEC) 1 xxxx yy	Enable/Block Size/Code Rate	1024 or 4096	12 selects 1/2 23 selects 2/3 45 selects 4/5
FC(FEC) X	Future Error Correction Code Capability		

In the event of an incorrect FEC command, the transmitter will return “ERR FC(FEC) X <CR>” to indicate the error and return the current FEC setting for the transmitter.

- b. Query Forward Error Correction Setting. “FC(FEC) <CR>” queries the currently set FEC condition and returns “FC(FEC) 0<CR>”, when FEC is disabled and returns “FC(FEC) 1 xxxx yy” when FEC is enabled.



- c. Refer to [Appendix 2-D](#) for additional details on FEC and the associated randomization used.

C.4.b(16) Space Time Coding

An STC-enabled transmitter is two independent transmitters when STC is disabled. The command prompt indicates which transmitter is communicating over the serial port. When STC is enabled modulation will be SOQPSK-TG per [Appendix 2-E](#).

- a. Set Space Time Coding. Use “ST(STC) X <CR>” where X corresponds to a 1 or 0. If the command is accepted, an “OK <CR>” is issued as a response.

Command	Space Time Coding	Prompt
ST(STC) 0	Disable	RF1> or RF2>
ST(STC) 1	Enable	>

- b. Query Space Time Coding. “ST(STC) <CR>” returns “ST(STC) X<CR>” where integer X is represented in the table above. “STC 0” is associated with a command prompt of RF1> or RF2>.
- c. Independent Commanding. The following command structure allows independent commanding when STC is disabled.
  - Upon issuing an “ST(STC) 0 <CR>” command, the command prompt changes from “>” to “RF1>”, indicating communication with the transmitter associated with RF port 1 (Xmtr1). The default command prompt is “RF1>”.
  - To change to the other transmitter, issue the command “RF2” and the command prompt changes to “RF2>”, indicating communication with the transmitter associated with RF port 2 (Xmtr2).
  - Commands apply to both transmitters independently.
  - Issuing “ST(STC) 1 <CR>” returns the “>” prompt indicating STC mode is enabled and commands apply as they would to a single transmitter. At the “>” prompt independent control of each transmitter is not available.
- d. Example Command Use. The examples in [Figure C-1](#) illustrate the use of several commands to configure transmitter parameters.

>	transmitter is ready to receive commands or queries
>ST	Queries STC mode
>ST 1	Responds STC is enabled
>	transmitter is ready to receive commands or queries
>ST 0	Disables STC
RF1>	Responds RF1 is ready to receive commands or queries
RF1>MO 0	Sets RF1 modulation mode to PCM/FM
RF1>ST 1	Enables STC
>	transmitter is ready to receive commands or queries
>MO	Queries modulation mode
>MO 1	Responds modulation mode is SOQPSK
>	transmitter is ready to receive commands or queries
>ST 0	Disables STC
RF1>	RF1 is ready to receive commands or queries
RF1>FR 4450.5	Sets RF1 frequency to 4450.5 MHz
RF1>DS 0	Sets RF1 data source to External
RF1>CS 0	Sets RF1 clock source to External
RF1>RF2	Selects RF2 to receive commands or queries
RF2>	RF2 is ready to receive commands or queries
RF2>MO 0	Sets RF2 to PCM/FM modulation mode
RF2>FR 4460.5	Sets RF2 frequency to 4460.5 MHz
RF2>DS 0	Sets RF2 data source to External
RF2>CS 0	Sets RF2 clock source to External
RF2>MO 2	Sets RF2 modulation mode to ARTM-CPM
RF2>ST 1	Enables STC
>	transmitter is ready to receive commands or queries

Figure C-1. Terminal Window for STC-Enabled Transmitter

## C.5. Extended Command Set

### C.5.a. Extended Command Set Summary

Although the extended command set does not include all possible commands, its use provides a standard way of implementing known features of transmitters. This standard will be updated at appropriate intervals should new capabilities arise. Commands in the extended command set are shown in [Table C-2](#).

<b>Command</b>	<b>Function</b>
DP(DPOL)	Sets or queries data polarity (NORM or INV)
RP(RPWR)	Sets or queries the output RF power (HI or LO)
SP(SLP)	Low-power consumption mode, sleep mode
VP()	Variable RF power command
CP()	Sets or queries the input clock phase
DE()	Sets or queries differential encoding (ON or OFF)
RZ()	Sets or queries RF power on/off pin polarity

C.5.b. Commands: Extended Command Set

C.5.b(1) Data Polarity

Data polarity is set or queried with the DP(DPOL) mnemonic.

- a. Set Data Polarity. Use “DP(DPOL) X <CR>” where X corresponds to a 1 or 0. Actual data polarity, when referenced to the input clock, does not need to be known; this command either inverts the incoming data or does not. If the command is accepted, an “OK <CR>” is issued as a response.

Command	Polarity
DP(DPOL) 0	Normal
DP(DPOL) 1	Inverted

In the event of an incorrect data polarity command, the transmitter will maintain its current setting and return “ERR DP(DPOL) X <CR>” to indicate the error and return the current data polarity setting for the transmitter.

- b. Query Data Polarity. “DP(DPOL) <CR>” queries the current data polarity and returns “DP(DPOL) X <CR>” where integer X is represented in the above table.

C.5.b(2) RF Power (High/Low)

High output power or low output power is set or queried with the RP(RPWR) mnemonic.

- a. Set RF Output Power. Use “RP(RPWR) X <CR>” where X corresponds to a 1 or a 0. If the command is accepted, an “OK <CR>” is issued as a response.

Command	Output RF Power Level
RP(RPWR) 0	Low
RP(RPWR) 1	High

- b. Query RF Output Power Level. “RP(RPWR) <CR>” queries the currently set output RF power level and returns “RP(RPWR) X <CR>” where integer X is represented in the above table.

In the event of an incorrect RF power command, the transmitter will return “ERR RP(RPWR) X <CR>” to indicate the error and return the current RF power setting for the transmitter.

- c. Example use. The low setting could be used for lab testing or ground checks when transmitter and receiver antennas are co-located. The high power setting is for normal, over-the-air telemetry transmission.

C.5.b(3) Low Power Consumption, Sleep Mode

The transmitter can be placed into a mode of low input power consumption with the SP(SLP) mnemonic.

- a. Set Low Power Mode. Use “SP(SLP) X” where X corresponds to a 1 or 0 as shown in the following table. If the command is accepted, an “OK <CR>” is issued as a response.

Command	Source
SP(SLP) 0	Full Operation Mode
SP(SLP) 1	Sleep Mode

Sleep mode powers down all nonessential circuitry within the transmitter to reduce input power consumption. Note, in order to return from sleep mode, the transmitter must monitor and recognize the SP(SLP) 0 command. In the event of an incorrect command, the transmitter will return “ERR SP(SLP) X <CR>” to indicate the error and the current power mode setting for the transmitter.

- b. Query Power Mode. “SP(SLP) <CR>” queries the power mode setting and returns “SP(SLP) X <CR>” where integer X is represented in the above table.

C.5.b(4) Variable Power Mode

The transmitter can support user-selectable output power levels using the VP XX<CR> mnemonic.

- a. Set Variable Power Level. Use “VP XX<CR>” or “VP X<CR>” to set a range of RF output power levels available in discrete predefined steps. If the command is accepted, an “OK<CR>” is issued as a response. In the event of an incorrect command, the transmitter will return “ERR VP XX<CR>” to indicate the error and the current variable power level for the transmitter.
- b. Query Variable Power Level. “VP<CR>” queries the power mode setting and returns “VP XX<CR>” where integer XX is represented in the table below.
- c. Look Up Table. The actual value of output power that corresponds to “XX” is undefined. Each manufacturer will provide an equation or lookup table that defines the output power as a function of “XX”.

Command	RF Power Level
VP XX	Full Power (equivalent to RP 1)
VP (XX – 1)	Less than full power
VP 1 (or VPP 01)	More than low power
VP 0 (or VPP 00)	Low Power (equivalent to RP 0)

- d. Variable Power in STC Transmitters. For transmitters with STC capability, the VP command applies to both transmitters. When STC is disabled, output power for each transmitter can be independently controlled with the VP command.

C.5.b(5) Input Clock Phase

The transmitter can support user-selectable input clock phasing using the CP X<CR> mnemonic.

- a. Set Input Clock Phase. Use “CP X<CR>” where X corresponds to a 1, 0, or A. If the command is accepted, an “OK<CR>” is issued as a response. In the event of an incorrect input clock phase command, the transmitter will return “ERR CP X<CR>” to indicate the error and return the current input clock phase setting for the transmitter.

- b. Query Input Clock Phase. “CP<CR>” queries the input clock phase setting and returns “CP X<CR>” where the value of X is represented in the table below.

Command	Input Clock Phase	Data Transitions
CP 0	0°	Rising Edge of Clock
CP 1	180°	Falling Edge of Clock
CP A	0° or 180°	Edge with greatest margin with respect to data transitions

C.5.b(6) Differential Encoding

Differential encoding is set or queried with the DE mnemonic. For additional information, refer to [Appendix 2-B](#). This command is only applicable when modulation mode is set to SOQPSK-TG (MO 1).

- a. Set Differential Encoding. Use “DE X <CR>” where X corresponds to a 1 or 0. If the command is accepted, an “OK <CR>” is issued as a response.

Command	Differential Encoding
DE 1	On
DE 0	Off

In the event of an incorrect differential encoding command, the transmitter will return “ERR DE X<CR>” to indicate the error and return the current differential encoding setting.

- b. Query Differential Encoding. “DE <CR>” queries the currently set differential encoding status and returns “DE X <CR>” where integer X is represented in the above table.
- c. Default. When switching modulation modes the differential encoding shall be switched appropriately. For example, when switching from SOQPSK-TG to PCM/FM, the differential encoding will be set to off.
- d. Manual Control. For the PCM/FM and ARTM-CPM modulation modes, differential encoding will always be disabled (off). For SOQPSK-TG modulation mode, differential encoding will be enabled upon selection of that mode; however, the user can exercise manual control of differential encoding when using SOQPSK-TG modulation. Additionally if either FEC or STC are enabled, differential encoding will be disabled.

C.5.b(7) RF Power On/Off Pin Polarity

The RF power on/off pin polarity is set or queried with the RZ mnemonic. This command sets the polarity of the pin, either a low or high level, to enable RF power output.

- a. Set RF Power On/Off Pin Polarity.

Command	RF Power
RZ(RFZ) 1	On when pin is high
RZ(RFZ) 0	On when pin is low

In the event of an incorrect RF power command, the transmitter will return “ERR RF X<CR> X<CR>” to indicate the error and return the current RF power setting.

- b. Query RF Power On/Off Pin Polarity. “RZ(RFZ) <CR>” queries the currently set RF power status and returns “RZ(RFZ) X <CR>”.
- c. Default. The transmitter will initialize in the RF power pin polarity on/off “On when pin is high” setting.

### C.6. Transmitter Communication Example

A typical terminal window is shown in [Figure C-2](#) for clarity. Transmitter communication initialization is assumed.

```

>FR 1435.5
>OK
>FR
>FR 1435.5
>MO 0
>OK
>DE 1
>ERR DE 0
>MO 7
>ERR MOD 0
>RGDW
>ERR
>TE
>TE 085
>QA
>FR 1435.5
>MO 0
>DE 0
>RA 1
>RF 1
>
    
```

Figure C-2. Typical Terminal Window

### C.7. Non-Standard Commands

 <p><b>NOTE</b></p>	<p>This paragraph is reserved for transmitter commands that fall outside of the commands and command structure discussed above. Additions to this section will be made as non-standard commands are derived and found applicable to this standard.</p>
--	--

### C.8. Physical Layer(s)

The above command sets are independent of the physical layer over which the commands are transferred. The command set should be implemented in such a way that it can be translated over any physical layer interfacing with the transmitter.

Should a three-wire serial interface be chosen, it should be compatible with TIA-232.<sup>47</sup> The intent of this standard is not to force complete EIA-232 compliance; rather, the intent is to establish a serial communication interface with the transmitter so that any terminal program,

<sup>47</sup> Telecommunications Industry Association. *Interface between Data Terminal Equipment and Data Circuit-Terminating Equipment Employing Serial Binary Data Interchange*. TIA/EIA-232-F. 1 October 1997. May be superseded by update. Retrieved 17 May 2021. Available at <https://standards.globalspec.com/std/872822/tia-232>.

such as Windows® HyperTerminal or Linux Minicom, can be used to communicate with the transmitter. A transmit-and-receive line will be supplied with an associated ground return; the choice of connector pin-out is left up to the manufacturer. The serial interface will operate at one of the common transfer rates. Typical baud rates are 300, 600, 1200, 2400, 4800, 9600, 19200, 38400, 57600, and 115200 baud. The default shall be 9600 baud. Should operation at another baud rate be desired, a command must be implemented to accommodate this capability. The command shall have the form BD(BAUD) as described below.

- a. Baud Rate. Serial communication baud rate shall be set or queried with the BD(BAUD) mnemonic.
- b. Set Baud Rate. Use “BD(BAUD) X <CR>” where X corresponds to a number (0-9) in the following table. If the command is accepted, an “OK” <CR>” is issued as a response.

Command	Rate
BD(BAUD) 0	300
BD(BAUD) 1	600
BD(BAUD) 2	1200
BD(BAUD) 3	2400
BD(BAUD) 4	4800
BD(BAUD) 5	9600
BD(BAUD) 6	19200
BD(BAUD) 7	38400
BD(BAUD) 8	57600
BD(BAUD) 9	115200

- c. Query Baud Rate. “BD(BAUD) <CR>” queries the set baud rate of the transmitter and returns “BD(BAUD) X <CR>” where integer X is represented in the above table.

In the event of an incorrect baud rate command, the transmitter will return “ERR BD(BAUD) X<CR>” to indicate the error and return the current baud rate setting for the transmitter.

Communication should be compatible with a terminal set-up consisting of one of the above baud rates with 8 data bits, 1 stop bit, 1 start bit, and no parity. ASCII characters will be transmitted and received. No hardware or software handshaking should be implemented and connector pin-out is left to the manufacturer.

This page intentionally left blank.



## APPENDIX 2-D

**Low-Density Parity-Check Codes for Telemetry Systems****D.1. Background**

The LDPC codes presented are intended to decrease error probabilities in a primarily noisy transmission channel for use in the AMT test environment.

The LDPC code is a linear block code. This type of code maps a block of  $k$  information bits together with a codeword (or codeblock) of  $n$  bits. Think of a linear block code as a chunk of input bits mapped through a coder to a longer chunk of output bits. This is sometimes called an  $n$ - $k$  code. When  $k$  bits are mapped to a length  $n$  codeblock there are  $2^k$  codewords; however, there are  $2^n$  possible codewords composed of  $n$  bits. The idea with error correction codes is to pick the  $2^k$  codewords of the  $2^n$  total possible codewords that are far enough apart (in terms of Hamming distance) to guarantee you are able to correct a certain number of errors.

This particular version of LDPC code is systematic, meaning the transmitted codeblock contains duplications of the bits of the original information. It is also a quasi-cyclic linear block code, meaning the construction of these codes involves juxtaposing smaller cyclic submatrices (circulants) to form a larger parity matrix, all through linear operations.

This code, like all other FEC schemes, requires an encoder on the transmission side and a decoder on the receiving side of the telemetry link. The codes offer much higher decoding speeds via highly parallelized decoder structures. The LDPC code itself does not guarantee sufficient bit transitions to keep receiver symbol synchronizers in lock so a randomizer, defined in this appendix, is required when implementing this FEC code.

Since LDPC is a block code, the start of a codeblock(s) must be identified in order for the decoder to function properly. This identifier, known as the attached synchronization marker (ASM), provides this marker and also aids in detection at very low values of  $E_b/N_0$ . Differential encoding/decoding normally associated with SOQPSK-TG modulation is NOT required and should be disabled. Phase ambiguities will have to be resolved using the ASM.

**D.2. Code Description**

The LDPC code is a linear block code with options for  $\{n,k\}$ , where  $n$  is the length of the codeblock and  $k$  is the length of the information block. An LDPC code can be entirely defined by its parity check matrix,  $\mathbf{H}$ . The  $k \times n$  generator matrix that is used to encode a linear block code can be derived from the parity check matrix through linear operations.

Code rates,  $r$ , chosen for this AMT application are 1/2, 2/3, and 4/5. Information block sizes ( $k$ ) are 1024 and 4096 bits. Given the code rate and information block sizes, codeword block sizes are calculated using  $n = k/r$ . See [Table D-1](#).

<b>Table D-1. Codeblock Length per Information Block Size</b>			
Information Block Length, $k$	Codeblock Length, $n$		
	Rate 1/2	Rate 2/3	Rate 4/5
1024	2048	1536	1280
4096	8192	6144	5120

The  $k \times n$  generator matrix  $\mathbf{G}$  shall be used to encode a linear block code. The matrix  $\mathbf{G}$  can be derived from the parity check matrix  $\mathbf{H}$ .

For each  $\{n,k\}$  in [Table D-1](#) a parity check matrix  $\mathbf{H}$  is constructed from size  $M \times M$  submatrices per [Table D-2](#).

<b>Table D-2. Submatrix Size per Information Block Size</b>			
Information Block Length, $k$	Submatrix size $M$		
	Rate 1/2	Rate 2/3	Rate 4/5
1024	512	256	128
4096	2048	1024	512

### D.3. Parity Check Matrices

Given the  $\{n,k\}$  in [Table D-1](#), there are six parity check matrices that need to be constructed. Section 3.3 in CCSDS standard 131.1-0-2 (CCSDS September 2007) describes how each parity check matrix is constructed and is repeated here for clarity.

The  $\mathbf{H}$  matrices for each code rate are specified below.  $\mathbf{I}_M$  is the  $M \times M$  identity matrix (main diagonal is 1's, all other entries are 0) and  $\mathbf{0}_M$  is the zero matrix.

### Parity Check Matrices

$$H_{1/2} = \begin{bmatrix} \mathbf{0}_M & \mathbf{0}_M & I_M & \mathbf{0}_M & I_M \oplus \Pi_1 \\ I_M & I_M & \mathbf{0}_M & I_M & \Pi_2 \oplus \Pi_3 \oplus \Pi_4 \\ I_M & \Pi_5 \oplus \Pi_6 & \mathbf{0}_M & \Pi_7 \oplus \Pi_8 & I_M \end{bmatrix}$$

$$H_{2/3} = \begin{bmatrix} \mathbf{0}_M & \mathbf{0}_M & \mathbf{0}_M & \mathbf{0}_M & I_M & \mathbf{0}_M & I_M \oplus \Pi_1 \\ \Pi_9 \oplus \Pi_{10} \oplus \Pi_{11} & I_M & I_M & I_M & \mathbf{0}_M & I_M & \Pi_2 \oplus \Pi_3 \oplus \Pi_4 \\ I_M & \Pi_{12} \oplus \Pi_{13} \oplus \Pi_{14} & I_M & \Pi_5 \oplus \Pi_6 & \mathbf{0}_M & \Pi_7 \oplus \Pi_8 & I_M \end{bmatrix}$$

$$H_{4/5} = \begin{bmatrix} \mathbf{0}_M & \mathbf{0}_M & \mathbf{0}_M & \mathbf{0}_M & \mathbf{0}_M & \mathbf{0}_M & \mathbf{0}_M \\ \Pi_{21} \oplus \Pi_{22} \oplus \Pi_{23} & I_M & \Pi_{15} \oplus \Pi_{16} \oplus \Pi_{17} & I_M & \Pi_9 \oplus \Pi_{10} \oplus \Pi_{11} & I_M & \\ I_M & \Pi_{24} \oplus \Pi_{25} \oplus \Pi_{26} & I_M & \Pi_{18} \oplus \Pi_{19} \oplus \Pi_{20} & I_M & \Pi_{12} \oplus \Pi_{13} \oplus \Pi_{14} & \left. \begin{array}{c} H_{1/2} \end{array} \right] \end{bmatrix}$$

Permutation matrix  $\Pi_k$  has non-zero entries in row  $i$  and column entries are defined by  $\pi_k(i)$  for  $i \in \{0, \dots, M-1\}$

$$\pi_k(i) = \frac{M}{4} ((\theta_k + \lfloor 4i/M \rfloor) \bmod 4) + (\phi_k(\lfloor 4i/M \rfloor) + i) \bmod \frac{M}{4}$$

where  $\theta_k$  and  $\phi_k(j)$  are defined in the following tables for the submatrix sizes defined in [Table D-2](#) for each code rate and information block size.

Code Rate = 1/2, Information Block Size = 1024,  $M = 512$

$k$	$\Theta_k$	$\phi_k(0,M)$	$\phi_k(1,M)$	$\phi_k(2,M)$	$\phi_k(3,M)$
1	3	16	0	0	0
2	0	103	53	8	35
3	1	105	74	119	97
4	2	0	45	89	112
5	2	50	47	31	64
6	3	29	0	122	93
7	0	115	59	1	99
8	1	30	102	69	94

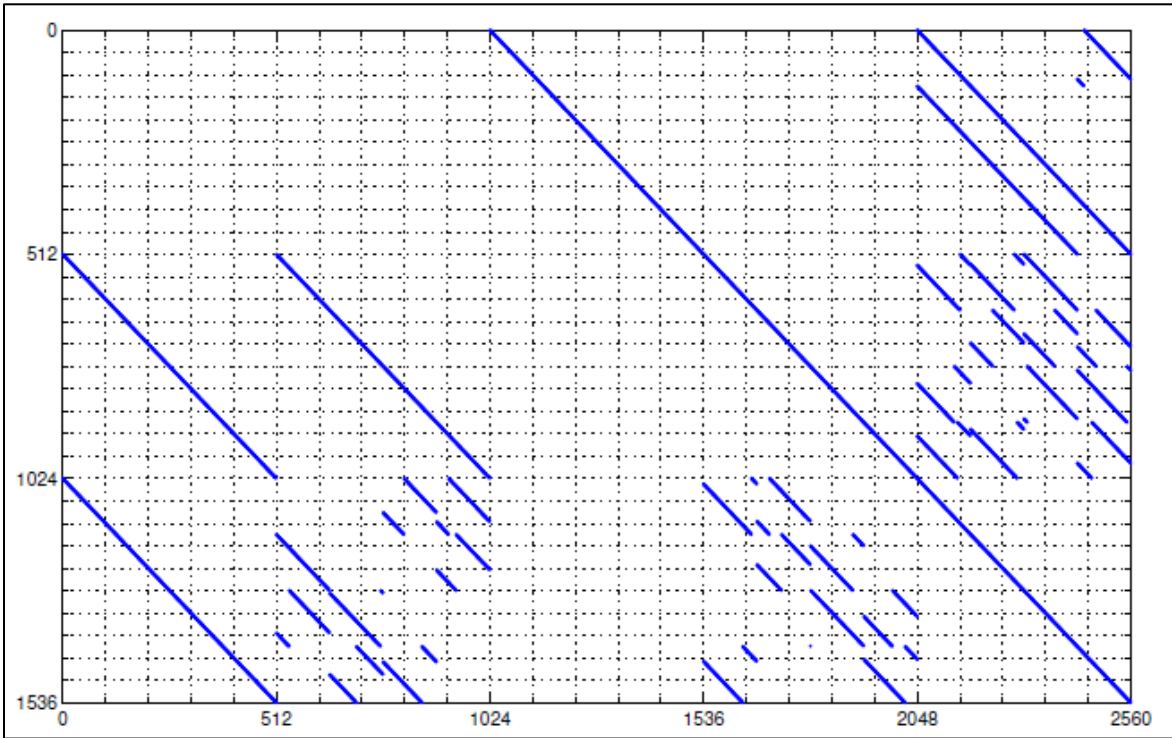

Figure D-1. Parity Check Matrix H for (n=2048, k=1024) Rate 1/2

$k$	$\Theta_k$	$\phi_k(0,M)$	$\phi_k(1,M)$	$\phi_k(2,M)$	$\phi_k(3,M)$
1	3	108	0	0	0
2	0	126	375	219	312
3	1	238	436	16	503
4	2	481	350	263	388
5	2	96	260	415	48
6	3	28	84	403	7
7	0	59	318	184	185
8	1	225	382	279	328

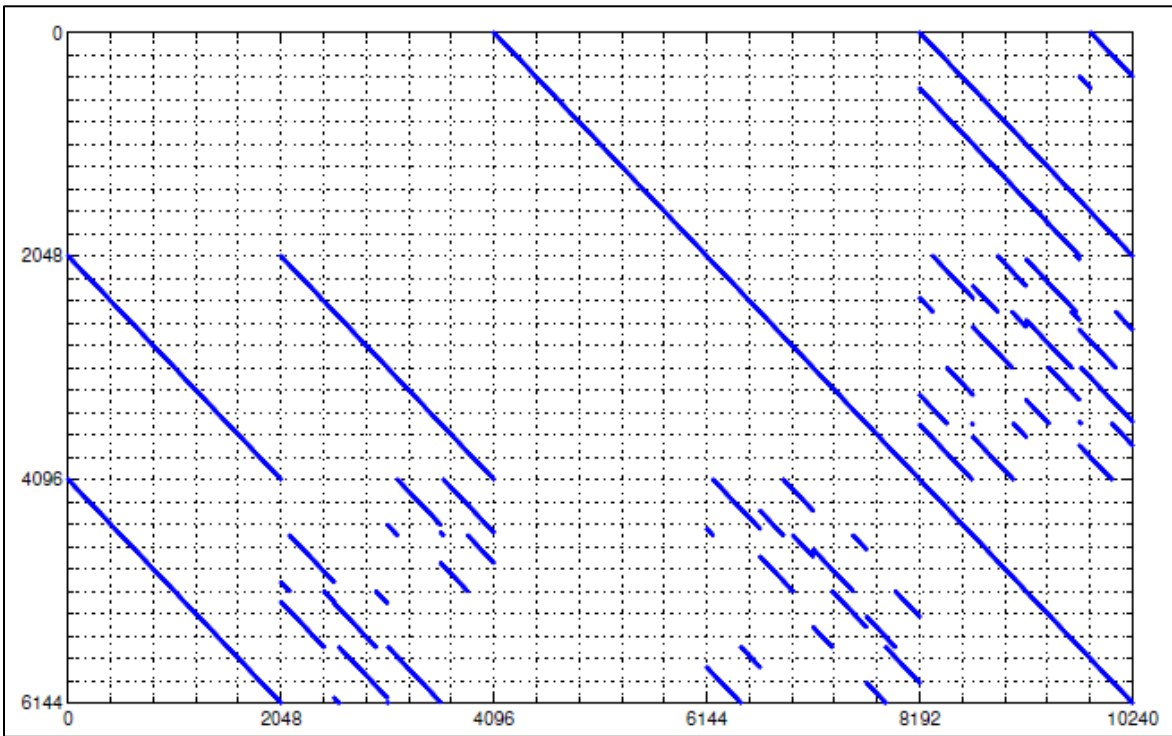

Figure D-2. Parity Check Matrix H for (n=8192, k=4096) Rate 1/2

$k$	$\Theta_k$	$\phi_k(0,M)$	$\phi_k(1,M)$	$\phi_k(2,M)$	$\phi_k(3,M)$
1	3	59	0	0	0
2	0	18	32	46	44
3	1	52	21	45	51
4	2	23	36	27	12
5	2	11	30	48	15
6	3	7	29	37	12
7	0	22	44	41	4
8	1	25	29	13	7
9	0	27	39	9	2
10	1	30	14	49	30
11	2	43	22	36	53
12	0	14	15	10	23
13	2	46	48	11	29
14	3	62	55	18	37

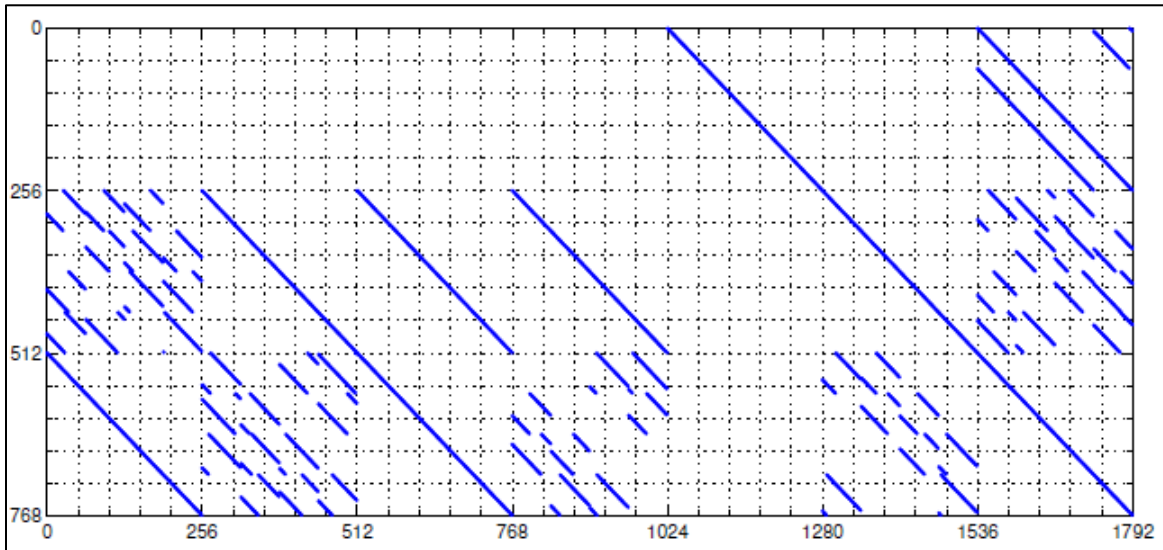

Figure D-3. Parity Check Matrix H for (n=1536, k=1024) Rate 2/3

Code Rate = 2/3, Information Block Size = 4096,  $M = 1024$

$k$	$\Theta_k$	$\phi_k(0,M)$	$\phi_k(1,M)$	$\phi_k(2,M)$	$\phi_k(3,M)$
1	3	160	0	0	0
2	0	241	182	35	162
3	1	185	249	167	7
4	2	251	65	214	31
5	2	209	70	84	164
6	3	103	141	206	11
7	0	90	237	122	237
8	1	184	77	67	125
9	0	248	55	147	133
10	1	12	12	54	99
11	2	111	227	23	105
12	0	66	42	93	17
13	2	173	52	20	97
14	3	42	243	197	91

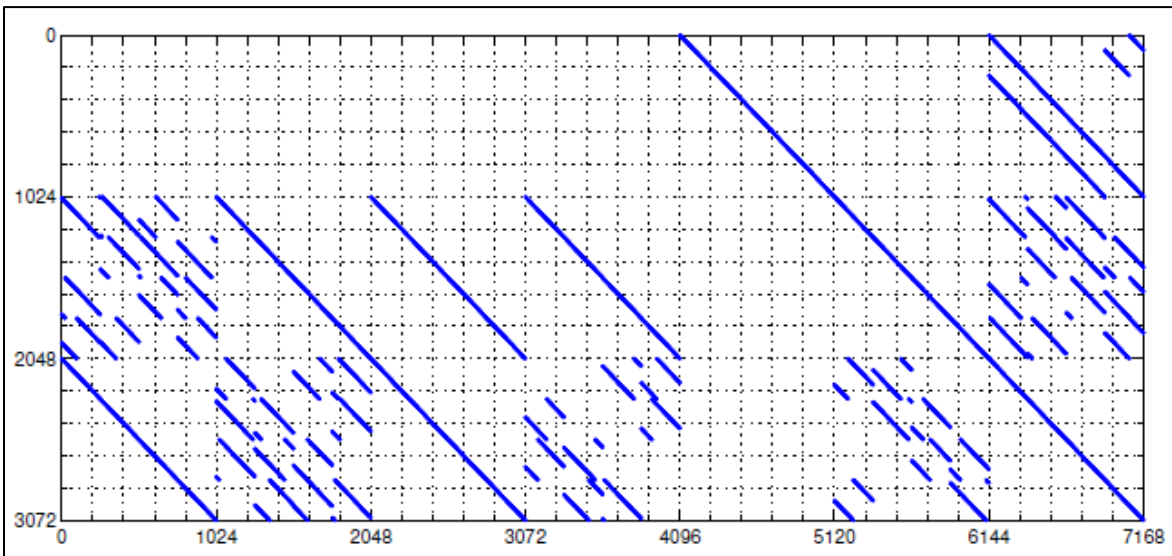

Figure D-4. Parity Check Matrix H for (n=6144, k=4096) Rate 2/3

Code Rate =4/5, Information Block Size = 1024,  $M = 128$

$k$	$\Theta_k$	$\phi_k(0,M)$	$\phi_k(1,M)$	$\phi_k(2,M)$	$\phi_k(3,M)$
1	3	1	0	0	0
2	0	22	27	12	13
3	1	0	30	30	19
4	2	26	28	18	14
5	2	0	7	10	15
6	3	10	1	16	20
7	0	5	8	13	17
8	1	18	20	9	4
9	0	3	26	7	4
10	1	22	24	15	11
11	2	3	4	16	17
12	0	8	12	18	20
13	2	25	23	4	8
14	3	25	15	23	22
15	0	2	15	5	19
16	1	27	22	3	15
17	2	7	31	29	5
18	0	7	3	11	21
19	1	15	29	4	17
20	2	10	21	8	9
21	0	4	2	2	20
22	1	19	5	11	18
23	2	7	11	11	31
24	1	9	26	3	13
25	2	26	9	15	2
26	3	17	17	13	18

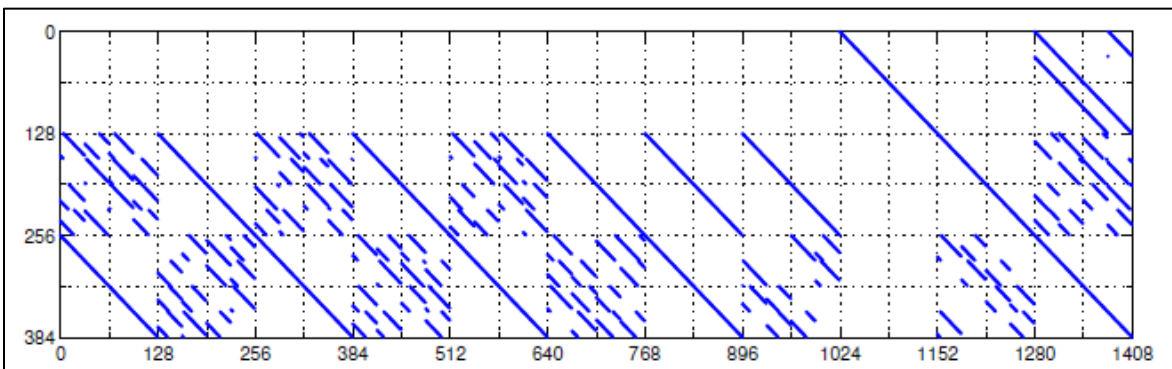

Figure D-5. Parity Check Matrix H for (n=1280, k=1024) Rate 4/5



Code Rate =4/5, Information Block Size = 4096,  $M = 512$

$k$	$\Theta_k$	$\phi_k(0,M)$	$\phi_k(1,M)$	$\phi_k(2,M)$	$\phi_k(3,M)$
1	3	16	0	0	0
2	0	103	53	8	35
3	1	105	74	119	97
4	2	0	45	89	112
5	2	50	47	31	64
6	3	29	0	122	93
7	0	115	59	1	99
8	1	30	102	69	94
9	0	92	25	92	103
10	1	78	3	47	91
11	2	70	88	11	3
12	0	66	65	31	6
13	2	39	62	19	39
14	3	84	68	66	113
15	0	79	91	49	92
16	1	70	70	81	119
17	2	29	115	96	74
18	0	32	31	38	73
19	1	45	121	83	116
20	2	113	45	42	31
21	0	86	56	58	127
22	1	1	54	24	98
23	2	42	108	25	23
24	1	118	14	92	38
25	2	33	30	38	18
26	3	126	116	120	62

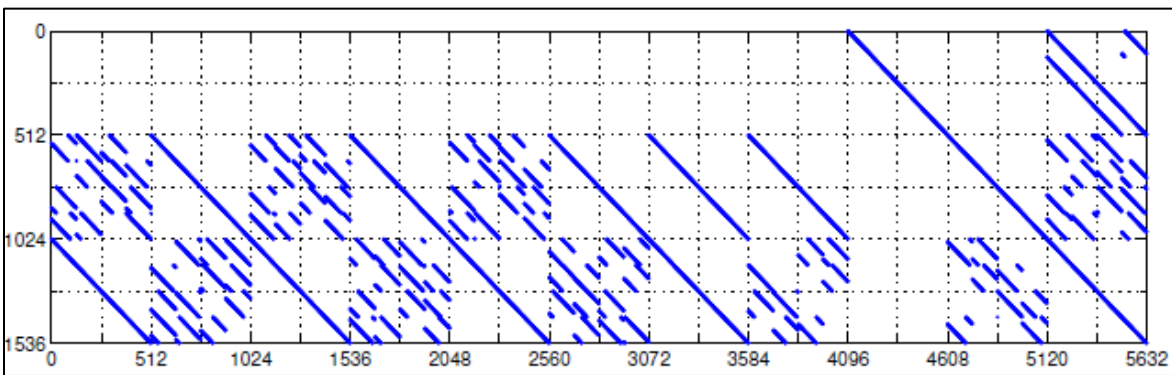

Figure D-6. Parity Check Matrix H for (n=5120, k=4096) Rate 4/5

#### D.4. Encoding

The recommended method for producing codeblocks consistent with the parity check matrices is to perform matrix multiplication (modulo-2) by block-circulant generator matrices. This family of codes supports rates  $K/(K+2)$ , where  $K=2$  for a rate 1/2 code,  $K=4$  for rate 2/3, and

$K=8$  for rate 4/5. Generator matrices,  $\mathbf{G}$ , have size  $MK \times M(K + 3)$  if punctured columns are described in the encoding. (Note: If punctured columns are omitted, as in this case,  $\mathbf{G}$  will have a size equal to  $MK \times M(K + 2)$ ). [Table D-3](#) lists the size of  $\mathbf{G}$  for each information block size and code rate.

Table D-3. Generator Matrix Sizes			
Information Block Length, $k$	Generator Matrix ( $\mathbf{G}$ ) Size		
	Rate 1/2	Rate 2/3	Rate 4/5
1024	$1024 \times 2048$	$1024 \times 1536$	$1024 \times 1280$
4096	$4096 \times 8192$	$4096 \times 6144$	$4096 \times 5120$

These generator matrices may be constructed as follows.

1. Let  $\mathbf{P}$  be the  $3M \times 3M$  submatrix of  $\mathbf{H}$  consisting of the last  $3M$  columns. Let  $\mathbf{Q}$  be the  $3M \times MK$  submatrix of  $\mathbf{H}$  consisting of the first  $MK$  columns.
2. Compute  $\mathbf{W}=(\mathbf{P}-\mathbf{1Q})\mathbf{T}$ , where the arithmetic is performed modulo-2.
3. Construct the generator matrix  $\mathbf{G}=[\mathbf{IMK} \ \mathbf{W}]$  where  $\mathbf{IMK}$  is the  $MK \times MK$  identity matrix, and  $\mathbf{W}$  is a dense matrix of circulants of size  $MK \times M(N-K)$ . The dimension of  $\mathbf{W}$  is  $MK \times 2M$ .

Because the LDPC code is systematic and the generator matrix  $\mathbf{G}$  is block-circulant, an efficient bit-serial encoder can be implemented as shown in [Figure D-7](#). Initially, the binary pattern for the first row of circulants is placed in the shift registers, and the accumulator is set to the length  $2M$  zero vector. The contents of the shift registers are added (modulo-2) to the accumulator if the first message bit is a 1, and the shift registers are cyclicly shifted right one place. This is repeated for each subsequent message bit until  $m=M/4$  cyclic shifts have been performed. The shift registers are then loaded with binary patterns for the next row of circulants, and the process continues in this manner until all message bits have been encoded.

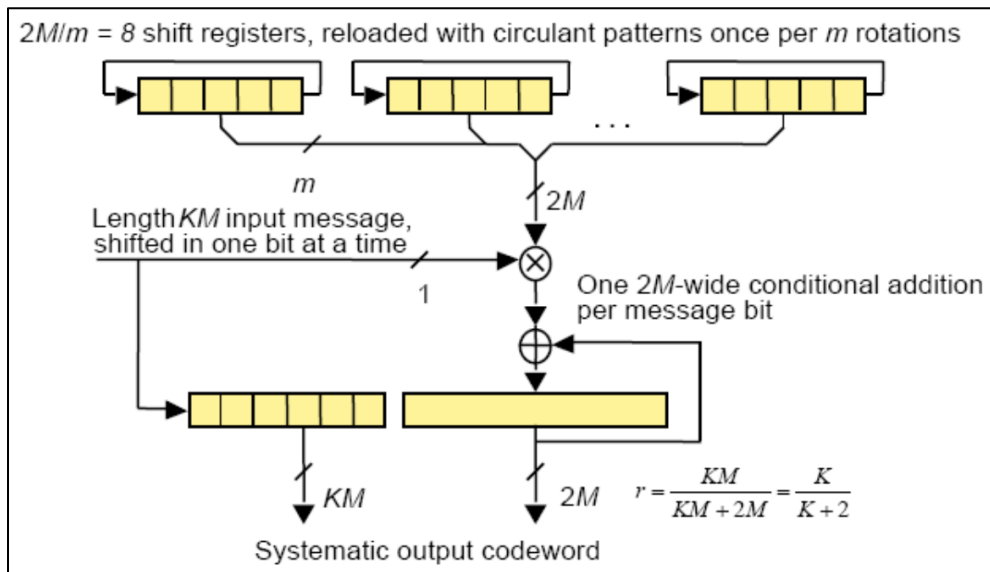

Figure D-7. Quasi-Cyclic Encoder Using Feedback Shift Register

Computing the generator matrix **G** involves inverting a large binary matrix, a computationally demanding task. For convenience, **G** for each information block size and code rate is tabulated here in a compact form.

D.4.a. Code Rate =1/2, Information Block Size = 1024,  $M = 512$

The first 1024 columns of **G** form a  $1024 \times 1024$  identity matrix and the remaining 1024 columns of **G** form a block matrix composed of 16 rows and 8 columns of circulant matrices, each of size  $128 \times 128$ . The first row of each circulant is given in hexadecimal format in [Table D-4](#) according to its location in **G**. Subsequent rows of each circulant can be computed by applying the corresponding number of right circular shifts to the first row.

<b>Table D-4. First Rows of Circulants in Generator Matrix, <math>r=1/2, k=1024</math></b>	
Row 1	
Columns 1025-1152	CFA794F49FA5A0D88BB31D8FCA7EA8BB
Columns 1153-1280	A7AE7EE8A68580E3E922F9E13359B284
Columns 1281-1408	91F72AE8F2D6BF7830A1F83B3CDBD463
Columns 1409-1536	CE95C0EC1F609370D7E791C870229C1E
Columns 1537-1664	71EF3FDF60E2878478934DB285DEC9DC
Columns 1665-1792	0E95C103008B6BCDD2DAF85CAE732210
Columns 1793-1920	8326EE83C1FBA56FDD15B2DDB31FE7F2
Columns 1921-2048	3BA0BB43F83C67BDA1F6AEE46AEF4E62
Row 129	
Columns 1025-1152	565083780CA89ACAA70CCFB4A888AE35
Columns 1153-1280	1210FAD0EC9602CC8C96B0A86D3996A3
Columns 1281-1408	C0B07FDDA73454C25295F72BD5004E80
Columns 1409-1536	ACCF973FC30261C990525AA0CBA006BD
Columns 1537-1664	9F079F09A405F7F87AD98429096F2A7E
Columns 1665-1792	EB8C9B13B84C06E42843A47689A9C528
Columns 1793-1920	DAAA1A175F598DCFDBAD426CA43AD479
Columns 1921-2048	1BA78326E75F38EB6ED09A45303A6425
Row 257	
Columns 1025-1152	48F42033B7B9A05149DC839C90291E98
Columns 1153-1280	9B2CEBE50A7C2C264FC6E7D674063589
Columns 1281-1408	F5B6DEAEBF72106BA9E6676564C17134
Columns 1409-1536	6D5954558D23519150AAF88D7008E634
Columns 1537-1664	1FA962FBAB864A5F867C9D6CF4E087AA
Columns 1665-1792	5D7AA674BA4B1D8CD7AE9186F1D3B23B
Columns 1793-1920	047F112791EE97B63FB7B58FF3B94E95
Columns 1921-2048	93BE39A6365C66B877AD316965A72F5B
Row 385	
Columns 1025-1152	1B58F88E49C00DC6B35855BFF228A088
Columns 1153-1280	5C8ED47B61EEC66B5004FB6E65CBECF3
Columns 1281-1408	77789998FE80925E0237F570E04C5F5B
Columns 1409-1536	ED677661EB7FC3825AB5D5D968C0808C

Columns 1537-1664	2BDB828B19593F41671B8D0D41DF136C
Columns 1665-1792	CB47553C9B3F0EA016CC1554C35E6A7D
Columns 1793-1920	97587FEA91D2098E126EA73CC78658A6
Columns 1921-2048	ADE19711208186CA95C7417A15690C45
Row 513	
Columns 1025-1152	BE9C169D889339D9654C976A85CFD9F7
Columns 1153-1280	47C4148E3B4712DAA3BAD1AD71873D3A
Columns 1281-1408	1CD630C342C5EBB9183ADE9BEF294E8E
Columns 1409-1536	7014C077A5F96F75BE566C866964D01C
Columns 1537-1664	E72AC43A35AD216672EBB3259B77F9BB
Columns 1665-1792	18DA8B09194FA1F0E876A080C9D6A39F
Columns 1793-1920	809B168A3D88E8E93D995CE5232C2DC2
Columns 1921-2048	C7CFA44A363F628A668D46C398CAF96F
Row 641	
Columns 1025-1152	D57DBB24AE27ACA1716F8EA1B8AA1086
Columns 1153-1280	7B7796F4A86F1FD54C7576AD01C68953
Columns 1281-1408	E75BE799024482368F069658F7AAAFB0
Columns 1409-1536	975F3AF795E78D255871C71B4F4B77F6
Columns 1537-1664	65CD9C359BB2A82D5353E007166BDD41
Columns 1665-1792	2C5447314DB027B10B130071AD0398D1
Columns 1793-1920	DE19BC7A6BBCF6A0FF021AABF12920A5
Columns 1921-2048	58BAED484AF89E29D4DBC170CEF1D369
Row 769	
Columns 1025-1152	4C330B2D11E15B5CB3815E09605338A6
Columns 1153-1280	75E3D1A3541E0E284F6556D68D3C8A9E
Columns 1281-1408	E5BB3B297DB62CD2907F09996967A0F4
Columns 1409-1536	FF33AEEE2C8A4A52FCCF5C39D355C39C
Columns 1537-1664	5FE5F09ABA6BCCE02A73401E5F87EAC2
Columns 1665-1792	D75702F4F57670DFA70B1C002F523EEA
Columns 1793-1920	6CE1CE2E05D420CB867EC0166B8E53A9
Columns 1921-2048	9DF9801A1C33058DD116A0AE7278BBB9
Row 897	
Columns 1025-1152	4CF0B0C792DD8FDB3ECEAE6F2B7F663D
Columns 1153-1280	106A1C296E47C14C1498B045D57DEFB5
Columns 1281-1408	968F6D8C790263C353CF307EF90C1F21
Columns 1409-1536	66E6B632F6614E58267EF096C37718A3
Columns 1537-1664	3D46E5D10E993EB6DF81518F885EDA1B
Columns 1665-1792	6FF518FD48BB8E9DDBED4AC0F4F5EB89
Columns 1793-1920	BCC64D21A65DB379ABE2E4DC21F109FF
Columns 1921-2048	2EC0CE7B5D40973D13ECF713B01C6F10

D.4.b. Code Rate = 1/2, Information Block Size = 4096, M = 2048

The first 4096 columns of **G** form a  $4096 \times 4096$  identity matrix and the remaining 8192 columns of **G** form a block matrix composed of 16 rows and 8 columns of circulant matrices,

each of size  $512 \times 512$ . The first row of each circulant is given in hexadecimal format in [Table D-5](#) according to its location in **G**. Subsequent rows of each circulant can be computed by applying the corresponding number of right circular shifts to the first row.

<b>Table D-5. First Rows of Circulants in Generator Matrix, <math>r=1/2</math>, <math>k=4096</math></b>	
Row 1	
Columns 4097- 4608	616DB583006DB99954780CD6DFC9908772D8260D390B1D462A8F62DE8809 216194BE0531EE408AEAF27F50F3AD71865AC7910EEF8824A858CA7B13F C843DAFB1
Columns 4609- 5120	BA3E0B010860D09066A8632E2B273DABDF90C26FCDD989C2831874EA7F BA23D940A294111C1B0C1CF62F56A376B94CF64FA594B987B19226E52570 4D7F2BC66E
Columns 5121- 5632	226C671C22A59AC062490596EB1536C9F66AE799C2489FAD2C131E29ED64 A25CB0ADC88D04C5EC8FECD7F78B3825E626858CFAA0DE77772CE8822C 7AA39628A0
Columns 5633- 6144	123B1C426E2A93366D067D26DE51362EA0BA916EBD1229521B1B044459B3 25785F3F3E24199B2460151E4CAA9FD26A5DC46BE0D6DA907EFAF38F413 642F702F5
Columns 6145- 6656	324AFD5D62F4CC251FF5C0FD95DE0FAB061F0C92CA5BC97F976118AD84 E0663A3BF1B4F07D1CCCC2DF9E09D506B073DED87CC0653C944FC7D438 223C0DF3EB67
Columns 6657- 7168	E62AE13F8D4000D616E814045495F6E969C473B059386F5DDBCC25F4002E B132D73A98414D85346F55DEBFF875F7CB9D2466A412D180E0A1ADA18D 281376A671
Columns 7169- 7680	8EB0FB6BB7B9AD2A2132010511077F6BD424B6F5B578C11D0076B781930F 755EBB72C41ED17519476C257C31C3159BF31FADA2755F1B8A23B22D6A4 28AA290E2
Columns 7681- 8192	54CC73C7599AB67C6807C4286BECF8423F3216EF04E1B6DE61349DDB23E 3A0EB0EF70C5BE1AD91D31B0BB532C1098DC619BF80F3853EEA357091C 05D95170A7E
Row 513	
Columns 4097- 4608	5E6381A718C0A817F8101ECDCDBF825E732E4356CEC42C222DBC476BD70 4837C382B7FBF282B739EDC22B5EEA2909F0EB3ACB9E41FE2AC791130A3 6A9CBFC1D9
Columns 4609- 5120	D4F8DE28FA77F37E4A6B5A82A58CE917CA74C8397E9DB8EDCB2BF65DB 91954457707FE876DFF812D4B99466DF479A00114F27E702249DB3E9311301 E9CE98703
Columns 5121- 5632	74FEAD0013FD861D67D7CE69D3635ECC6266E862D08B63077B45D3098306 EA74159DAEA2263E58705EA5ABE58B7FD41862B9EC1D0F1BD47CD6CB4 2739C24F7FE
Columns 5633- 6144	7ACFF6D64C8E8F94BEABE280CFDCFCFB26AC7330073C25E0313DCB75E 6C5261F15D82AFA665F73A4B4DA4E5D1648EAB051EDEB9857C13C2F019 FCBBA4F9DF2E1
Columns 6145- 6656	9CEFF1147D792C14AA2E211C3B9B94B2C9F24F49B0B1ED6E200C88D743F 5AC1EE283C3A0AC79B9F1F496BDE74A2AA591ACF2F526FB24413A58B49 5F91905F596

Columns 6657- 7168	D8F1469BCA9CC5041C50F1FB479CF2680503AD85BA2C0C6D01D2D739F3 129315E49A9F57236D9585CC0B8A9B4BFE9ADCD97BED9006C33976ACCO 0468693D56FA
Columns 7169- 7680	1EE66371B0EA6C4E1E172C2C5D76806CB7376B8CDEAD96B14A1EC2B656 298B9425EA2F0671082D70AA23C267D1F215C59239AEB40186DF0AB28462 5DC6BAF45E
Columns 7681- 8192	FBFB26BED98BB3B697764A6F82C94039CBF14CB538A7D87801ACBD3A4 44A858BB74F0A4707592EE6B7DC6D21B8F6B4A184B567C8AA4CD825EBF 7F1EDCE015A5
Row 1025	
Columns 4097- 4608	25453670647D23C5E445A705953F3BF4A5AF02E7BC46C969C8141D8782F17 1C9CFF7EBB20945DE5D363AD36D3BD5A0BA081C079CDD04B6E5968187 C8A665344A
Columns 4609- 5120	23E9B1897A6FDF427B5E910AA8D71F9CC6351474BC4563C20FD38953295D 3BA15E7D1010503B7BA1C148251DB8A88AC64E6AF8C1CC056E4EEF1C92 7FEC40C35D
Columns 5121- 5632	57140969483D9E33429FAFD177D031A43B727CF832C8DFFE8D8960CB55BE 4BE27B69CC26F2FB731B53250D6F8EE7DFDA98812B9AAE9C02AE2FEDE A598D6B6E2F
Columns 5633- 6144	22B6CCA50541BD9F5D48565E551B310E10A0DFCB8035A5EC86EB9CD8C8 11CDCBCCCEC3732EF93EE8C9418E25CA5744E07C45F9B161E277BCECE3 88B9B84AAEC4
Columns 6145- 6656	DA37FE277C72CB5CB1BE92AD373867403E46B3535159687ADC79C39DEF7 005C1F11F1CBD5F8877DA66AAC156EF27BB893F5F1132336D52E8AEB60E ACF9BEB3CF
Columns 6657- 7168	D204D92DFA496DAF564272E3FEC51CE53C8F2DF6ACB191E60E14CDEA28 FD5ED0EBE09672ED11A3F6466FE3A967A4EC8390303059AE00DD83102A9 F33B2943E4E
Columns 7169- 7680	6E56928E7FEE3333A36FF3EE7598744CF7C298FEF3EACC7CCC0F36DCBA6 D87BDD441081163A65E27C958AF79C33A98B81814015E77F82EF5120FBDA B540893B4
Columns 7681- 8192	7BEB68CC37F23835C91F5D36D6BA6F0A5E68FEBB6E6A2F247EB5CF57684 D0770249460788DFDC4A1218652BF881B4BB06308EF86484E7070AACC72D 3977CF5D0
Row 1537	
Columns 4097- 4608	6230DEF1ACD4425F7B155A2A285CB2A32CB9D46DA09B28167826E77AEB D85F0C416595E136184841451F5B3E1F17D02C3DB32C2AF50091D6376406D 8CB78A9E3
Columns 4609- 5120	D3B19911ACC450679EAE25B0F290FF372300F1A4BC91A43CB79DB270133 D41DC4970F1420E71C0F816EF938C3C17F0FCBB6E920ED853EAF6D2DC67 92BF87098A
Columns 5121- 5632	B94C2E5DDE78C974AD6F423CD5ACA01EC9420AAF3FE83BEC31D47AAC D3D62FA2476C38595BD66639368181E75B44BAA7ADBC2B42E1D82D7A59 312BB9A16F7D35

Columns 5633- 6144	0B13B44D828071E69DD90DCD9B713A05FD8C21AA5E6E6D8DA49A5C3B3 4F98A4E5E822513F0DA200235C65BFCA1DC2CE4AB21D146B778F6806680 B8AC75285760
Columns 6145- 6656	FEF66B861AA67C768A76D585DFADC8EB6556AD841DEA9F44ACB42B601 6142B6B69F1833474FADEB0400CE4D9F3BD62AD96E57F3E93DD229180F2 D4B5E77D098F
Columns 6657- 7168	EEBE2DFA4D4D86ECB07EEE9565FB589855E1F53BA1B9784A8D195A0E37 21551270089C535216636FBEB4D9E50A9EAC3DCB27891A7005A2AD87427 E6B8326F6B3
Columns 7169- 7680	CA225C7B2A9EABFFDDBC130B5342917848B029917BA98FFD6EF238900 6A6B417F678C61458EF625C96C0D3D07945ABB9836CF80823EB6244D86D1 14CC5DC2B1
Columns 7681- 8192	94F5D55C398B16A71497C4CF102C2F1035C19D5DFC8A301B8DE33D41D90 9C15A3093B09E7489CE6AA14B331B70E76637FE6DDFFFA6DC4C510371C B0D2A6EA3DA
Row 2049	
Columns 4097- 4608	AC5F866DD75CD4C2D5959AC37DE4E1E870313A5B2902F234CD939FE39F3 1FEBF8B46DAC906E3EBA9C3A74DE46E7A9140D3716667BB1EC22A87D5F 8D048BDC5BA
Columns 4609- 5120	57B6024327CDDFF3296BE6508C48045B71FA519156F8C125F4E3B7356576F 32C63BC588908C4E8B3F9F2D12A9E8F35B6FCF296C17FD8E8D076406FA11 D16175F
Columns 5121- 5632	CC45AE82D672979E8A0A359B2328C79AE61F87EBE04DAC93430305486597 32000CE627417B3F8CFD4A992E7F2B680216AF773385B9337E1743D43FD96 5282CF5
Columns 5633- 6144	AE71B0CAFEB4DA3E0B95F1341667C519FB9F89D7CEC711E57485F04A965 CDC832CBEC0BE1B2A3E23B5EAF4C5DAD8767E054B2225A60B88BE1DB6 A35E0BAEB237
Columns 6145- 6656	A206BC721B252D52EA1F8E311203DFF0AE8D65BD1986055701A3C7FEB2D DEDD2D57C3BBA6A2BC56A9157677D7B48AD2907927176F6B22E8A92F6E 9863C9E16D9
Columns 6657- 7168	11B6209E06EFE6ACBBBA2214EF5AEAB9D76645476B2C16B8D14E1AE3F3 A85188835922B914D3F32FE05B7987A2516B3D3C8983AE176DFD04349A45 359B422E1E
Columns 7169- 7680	01CC2266F2B68A4323F8931D7AA37B1CBD70DC2FEE91592327207AA6121 795150A0DC918704A1A293778FE75A99FDCE77E820D0905EF7AC72A682F2 487A6E0FE
Columns 7681- 8192	03F42D94FDE1C13F958DF61112DB4A27A8A8EF35087FD089729F0864C270 6CCB2B6CBD91A9A7B7B31E08EA3570A6E1BED495FC84FACD829F3234B 1D1DC574B67
Row 2561	
Columns 4097- 4608	900AA496432959141795C615CBAEA98002440A0D447EF990435E452CC6902 03BDEBCBA3EEFC7A7CE71EB54B1728AEA9EDE70A7E6A1A8AE8616870 9A899738CCB

Columns 4609- 5120	C5B7A094AEBEA8EC95A414A8DE5D3DBE6745CB0D330B78435AC2BB666 6BB2D43A19EAD3B3D9536D0BB92DB949570981C22805E7DEA452FA649C 84EDC4324A7FB
Columns 5121- 5632	E6A9CAF4EE48400720B8F84CAC3A42483B7E571846E2A5F77A983EE31117 9CEC2D99878FF5AA06ACA0CBBA63B36985E0970761E7F837650BC46C9A 2EB1AEFA95
Columns 5633- 6144	AC4D8AA5C970BB55FDF3408356C9EB2683B6FEE593736B66B49C055BD65 03EEF3C7CADD15C9B86DCA626E1ABF4B971D04C0A9A5AEF8305C3D0E4 CC02C32FA91E
Columns 6145- 6656	D8949EF8FEADF7DA39D395B52D2779A0B305C4FD10C33A434878967D932 1B4835C035CA5802C37F6DC1E39AC30337253114176BBB26576317C72E954 8F179A5A
Columns 6657- 7168	A200FC35B6A0934D57543A60F6114B7B0D78D8DD8932538E545D806A1D9 E47390F092501F4A470CF7B1F9144D0A8F1B0C3D607930A75E5A150233DC EEDB4C10B
Columns 7169- 7680	217C8EB38D4D2A0EF12557321D504ECA670B41E496441FDE341F0232101D 4E3F4158FF6F4EAECC073AA811DD450F528BC6095868B7BF953926056BD4 09E5FE36
Columns 7681- 8192	B82831B150B80A736D6CF7B16660ADCD5E1F4DB96E36E33DCC2F1506C7 B8B0F2A4EC362FB0CF7B8B3B08D6CD1AF7440729D4C3C02627AD8733A0 C94B2EBAF526
Row 3073	
Columns 4097- 4608	FDB4463E6F8FB AF565B1C3320F5704A87309E529842378ECB733784F1CBD 85F4F87FB0525C7C4D307061F74DE2FB3BDFBC77E04EAB75A64FFE51203 AB925E807
Columns 4609- 5120	1D1101A16A2C41DBDCA94C128560BEFDA4ECA6F22B44C6E5085A23F841 06E4FD870FAA789E03FC37086E67B69FC8EB6421AA57FBA27866DF712D 5FEDA21FC51
Columns 5121- 5632	76EE3CB2C4A8629C20FC646A7ADF2A4BE73DCEF53FC926067EB9964996 BCEE403C5642CD2F8084E0C14D3627FAD9F0180DADF07331246C007F3AF 95CC9B451CC
Columns 5633- 6144	3638887EB493F5EE3361F07E00F115BC04AF404BE6BA3467322B37A8E6AB F47710D56C3BC751892CFD12F29CC4319D0562005562D05261D39FDF528A 11E65BBE
Columns 6145- 6656	A0BF07C52E9A9ED7AC3F0FB9196A450E162009509F20BEE74FCC6316BC4 824D93CBAC25E470A7468A629EB520E980DE31F8C8873F4ED21B57AAEB F43A5754359
Columns 6657- 7168	CD089ABE548975678C2123223CF3F345AE0CECF0A3726BFBB130E34169A 874B6C4CDEFC0A05D7DA1EE475E5407F1535399086700874C13000E2EE21 DF3EEFB65
Columns 7169- 7680	4BEF6F2B4137DC6EF197D514E904B8F31BAD6C846D6BD7D7480F4818C3C 57B4C7F53F168E48020273702071EE48EC53422C71C90AA0262982B82BB6F F3100D8A



Columns 7681- 8192	EB3E8F033DA73FA82B3B93E50C60E5936A07D3218946588D0EFB39E1A55 C0FB9DBA87DA50C4697EE2ED72B004301019E595B92A2F55F7F1B37C203 0B79057F52
Row 3585	
Columns 4097- 4608	59CA13359E16B10A7F8778BBAF5D45E32C643B524022FE777A8F557C1414 1D638E84BC4DBB1CE5866CD0B89C1CC5C6F7BF7E25D2B4FC28A16E67C F8BFAC4F4BD
Columns 4609- 5120	A612F30067700487B6584B1AD578659FC2B7443228B2B7B443882DABBF55 739CB9660F530631A2CFDCBE94D21692CAC01DA9EB5048FFF17BC4FB59 57E8C9DF1F
Columns 5121- 5632	29E0573D85359FB7924AABBDDDCD26F5740FFA6824FCFCBD53BF1DFB5 87E0667641DD3F82962F5E6EA26461279B0F69479645462983DBBBCC544D A90255121EA
Columns 5633- 6144	A97C7B71923F0382DF60C9E34D84CAC289B578899EBCF924F4304B80581C 9887B1198F074143DCC4324D7DF301466AC97903E688DD2E9186EDD2D90 C34202AA3
Columns 6145- 6656	90815D489B715FF604788F335322DF5C8856FD85F753785A96F4B2561990F4 58C69D3F99A8ED1BE99C3F5A14B19B37AC729B3F35ABF52006E814B5971 45FA3FD
Columns 6657- 7168	86A5A2038BB67CF8225BCCF7A587E0D09B47D26BC4DB017F6A77B6DEC5 AF5B117E399D8A336358D4AABE9C8E7EAAF6447638F2DC66EF65C100D0 6EE202013042
Columns 7169- 7680	AD845A43D23E66FBA72D9D56457D66C7E44D98ED1E5F1D063A5D010439 30E9C2EDED8BA9DEE5F9DFF91CD887F097B9A2DF0099E278C253E0A549 C7A2D81078C6
Columns 7681- 8192	680566EA7A1E724A99B5D7099AED278A3065BBC64BED441154DCD346D3 8C9771648D55656B16CF012D0C6EC8F616D3B758089A8147D731AE077D55 7204256F93

D.4.c. Code Rate = 2/3, Information Block Size = 1024,  $M = 256$

The first 1024 columns of  $\mathbf{G}$  form a  $1024 \times 1024$  identity matrix and the remaining 512 columns of  $\mathbf{G}$  form a block matrix composed of 16 rows and 8 columns of circulant matrices, each of size  $64 \times 64$ . The first row of each circulant is given in hexadecimal format in [Table D-6](#) according to its location in  $\mathbf{G}$ . Subsequent rows of each circulant can be computed by applying the corresponding number of right circular shifts to the first row.

<b>Table D-6. First Rows of Circulants in Generator Matrix, <math>r=2/3</math>, <math>k=1024</math></b>	
Row 1	
Columns 1025-1088	51236781781D416A
Columns 1089-1152	B0C8419FA21559A8
Columns 1153-1216	5F14E1E4D88726F1
Columns 1217-1280	762F6ED6CF32F06D
Columns 1281-1344	8ABFD971E17A0BE9
Columns 1345-1408	A5D147741B698D14

Columns 1409-1472	2A58AB30E2BC32D3
Columns 1473-1536	9F251FBC5DB8C768
Row 65	
Columns 1025-1088	D73C205BBEB231CB
Columns 1089-1152	CAB5EFF5B2C76C71
Columns 1153-1216	FA70FAD48828355F
Columns 1217-1280	68C6138FA5524A61
Columns 1281-1344	BB20031D7AA8FE69
Columns 1345-1408	432ADE446F49CE27
Columns 1409-1472	5E5DB9CCCEBD1326
Columns 1473-1536	E8782B1B01F2ABA2
Row 129	
Columns 1025-1088	4748E9513B41147A
Columns 1089-1152	17B1FBB78B4F914C
Columns 1153-1216	281F5680BA56DE50
Columns 1217-1280	74B0FB0817E33E2B
Columns 1281-1344	DD166CFB774B5959
Columns 1345-1408	AC7FDCEA4FECB5BE
Columns 1409-1472	ED747C81B540D66A
Columns 1473-1536	B2A6A2039A87967F
Row 193	
Columns 1025-1088	4780DCB2DC5CBFAE
Columns 1089-1152	55BC8FF84EC89440
Columns 1153-1216	E5D411223F09979F
Columns 1217-1280	DDDE9D940A15A801
Columns 1281-1344	194064639D254969
Columns 1345-1408	1BE32DDC829B0032
Columns 1409-1472	1326515A22EE88A2
Columns 1473-1536	0EC664DD2D701891
Row 257	
Columns 1025-1088	69748DFE6372F2EF
Columns 1089-1152	15F3B0D400ACD68A
Columns 1153-1216	CF4144CE1FE2581C
Columns 1217-1280	79B1A55BA59E54AE
Columns 1281-1344	65A2B47EEBAB0CF3
Columns 1345-1408	24DD87572CB0F71D
Columns 1409-1472	F24ABF15590F4DA6
Columns 1473-1536	9C3BAE51969C6502
Row 321	
Columns 1025-1088	D3A714B60B22789B
Columns 1089-1152	3DF5504D80F54C5A
Columns 1153-1216	9D75CF1465031211
Columns 1217-1280	09834A0C9F659C99
Columns 1281-1344	B9241BDF76EB3788

Columns 1345-1408	6F927251C86DECF1
Columns 1409-1472	390BE9F5BBB93D05
Columns 1473-1536	C6F435BFA1FF96B6
Row 385	
Columns 1025-1088	222461B658DC3E91
Columns 1089-1152	B01DF2A2EAD2DAA6
Columns 1153-1216	5572EE6278F6F63A
Columns 1217-1280	17B63CB2FDA3B97F
Columns 1281-1344	B233BB259F3D83F7
Columns 1345-1408	F64760C774989384
Columns 1409-1472	46F57E03F55B1C0B
Columns 1473-1536	5AC8A6CEA05466C1
Row 449	
Columns 1025-1088	AE8825521F85CA31
Columns 1089-1152	37BEED74B5303407
Columns 1153-1216	751FC9A15FCEE486
Columns 1217-1280	93F0F69BD04E72A4
Columns 1281-1344	C0EBFA3F49DF4DBB
Columns 1345-1408	03E52D815DC99A1D
Columns 1409-1472	98FE8BF01BB2CD6D
Columns 1473-1536	009C5290D81A18F6
Row 513	
Columns 1025-1088	4FFBAD88545CAA95
Columns 1089-1152	0C74659FA4828CA3
Columns 1153-1216	60CE56E32DA28B2E
Columns 1217-1280	299D4BF82FE54B81
Columns 1281-1344	51047BE3B3AE4F4B
Columns 1345-1408	F3AC9578B9477A4C
Columns 1409-1472	3730F81F92767E11
Columns 1473-1536	04E84EC3A3AD1F19
Row 577	
Columns 1025-1088	2D0E0CAB8EDD2185
Columns 1089-1152	CEFB8E8F2F538522A
Columns 1153-1216	92DAEDC22C441893
Columns 1217-1280	BCB999157B35619D
Columns 1281-1344	069951BFB90A08E1
Columns 1345-1408	54C7E270CBA1656E
Columns 1409-1472	7FB8B806B6A06FB3
Columns 1473-1536	7224943B1C3A5723
Row 641	
Columns 1025-1088	1BAA14752EFCEBC0
Columns 1089-1152	CFF0894975557623
Columns 1153-1216	FA95908DC3F34D48
Columns 1217-1280	FECA650999A26E91

Columns 1281-1344	245433EBBE9CDA13
Columns 1345-1408	5771EAF9B02D8FC
Columns 1409-1472	BCEBCA573D3775C8
Columns 1473-1536	1E46F2B951D0EAAB
Row 705	
Columns 1025-1088	32942F7F4743DDF4
Columns 1089-1152	8FA2F60AD62095EF
Columns 1153-1216	80E4A736B5E1A3A3
Columns 1217-1280	0119062872DAEDF4
Columns 1281-1344	E78006958CD99F95
Columns 1345-1408	D20625057C99C7A3
Columns 1409-1472	B569736DE2167610
Columns 1473-1536	0E1C6183ADF09FD0
Row 769	
Columns 1025-1088	E5C492DBB48B319A
Columns 1089-1152	E2D83ADEFEBBDEFE
Columns 1153-1216	AA944EEA53C77DB3
Columns 1217-1280	0FAA85D9C13B1F73
Columns 1281-1344	8ACED57F3BE4E807
Columns 1345-1408	33CB72627624F426
Columns 1409-1472	A0C6E669B5C74980
Columns 1473-1536	ABBAEFEA2D3B69AA
Row 833	
Columns 1025-1088	F8366DDAE56A6DDC
Columns 1089-1152	FDED5582F4EA6525
Columns 1153-1216	4C9628278ED17036
Columns 1217-1280	6E711B6D20A67966
Columns 1281-1344	3B28BDF004C21B93
Columns 1345-1408	1BC37B730FFC1786
Columns 1409-1472	5D20C81D345FE4B9
Columns 1473-1536	1D14A5663D369A93
Row 897	
Columns 1025-1088	5EBD4BD39B2217D0
Columns 1089-1152	56833BE1CDDBA6BC
Columns 1153-1216	B288169B4E3BB726
Columns 1217-1280	C2ED28FBFC395D1F
Columns 1281-1344	035B30C68F9A6B6F
Columns 1345-1408	539836A6E56A7B16
Columns 1409-1472	CEB1525C6ADB65A5
Columns 1473-1536	5F71754AA458B11A
Row 961	
Columns 1025-1088	0DB9D180B21C0B13
Columns 1089-1152	417D86C59DF33E49
Columns 1153-1216	183A8F6C44DAFA24

Columns 1217-1280	4E224C180C1F0B45
Columns 1281-1344	C93CD9CA23658555
Columns 1345-1408	7DDEC5E9451AD519
Columns 1409-1472	B122C72A6177EE99
Columns 1473-1536	1290B4C6B007D973

D.4.d. Code Rate =2/3, Information Block Size = 4096, M = 1024

The first 4096 columns of **G** form a 4096 × 4096 identity matrix and the remaining 2048 columns of **G** form a block matrix composed of 16 rows and 8 columns of circulant matrices, each of size 256 × 256. The first row of each circulant is given in hexadecimal format in [Table D-7](#) according to its location in **G**. Subsequent rows of each circulant can be computed by applying the corresponding number of right circular shifts to the first row.

<b>Table D-7. First Rows of Circulants in Generator Matrix, r=2/3, k=4096</b>	
Row 1	
Columns 4097-4352	80924F648C014F2C73889C8B87D0491FA9FA060D2902D7ACC8B679CF61 EEB5D9
Columns 4353-4608	6BB9E90F5C157AA1BF03EF756245D9179063F2CD999EF1E7F7925B3FB7 AC7B2D
Columns 4609-4864	6CD39516B201F491E2BDCA4E34542B5AF3703B3C8EE753FBE998E87323 F0B228
Columns 4865-5120	D1F551B2D7E7822F201E24066584D63CAA00E8DB909EB41C4157EBA0F5 C76A50
Columns 5121-5376	F7C5731746C6DAC260A345189009C0B23372F1E9E0C5A079D00B09158E1 64B22
Columns 5377-5632	33D5F8A268041CAB66317898CD0024E3106EED5C2171B3F6276B8EA59A A981E0
Columns 5633-5888	010BFF3F52A49ED9A6FA7F151FCC72B2AF3BD932065043F7447B4D0FC4 A2B93B
Columns 5889-6144	F8D345E6D2B0008D1B363BFE296B55AF38E3E16EC5856A122E4931CB3F 2424B1
Row 257	
Columns 4097-4352	A099B776C642FF1D84B0DB797098E17E75FE9BB5CF7FA8739711A89660 DAF24D
Columns 4353-4608	3CA8DE5500F68DB449BFF74251B24E4691EAF386C81014C91AC700298E 095F0B
Columns 4609-4864	12CEE8B5F6B93C11AD628CB6CB81F76BE095C2C994A8BDDB4E2C48C9 42B4D481
Columns 4865-5120:	1F7E191B30E8FFD6D4A7E9BEF81BBB0AE6608F647B1AED9CCA7FEC54 98C03F0F
Columns 5121-5376:	1132E816BDFA0C3450C3993911E10EB1097CD7A1F32C54C8B009654E56 B25A2D
Columns 5377-5632:	5FD58EEAED460CEFC18E2FBAD2954467E32118F01D05456DEA2926A1E 761DF76

Columns 5633-5888:	4C6C7BF3A2245C1B4630775DC59EA74A14EBCD8B5D72E343BC6F7FEA 452F2CC2
Columns 5889-6144:	C09CE802B35EBF46D1F3069957DF1D152377F45ADF614CC0F5DAB8FCF 394CCD0
Row 513	
Columns 4097-4352	FEFBA8CE169FD3775B2280EF3BD870FDDDF7CB95F2943D0EEA84529FF0 D1B1C19
Columns 4353-4608	0CA5DB06A87541C81BEF913D5145F20EFAD861F673B32028B4713377C0 56CE97
Columns 4609-4864	CA3F213365EE380F7E90466945BDE9F44087C8C73A7CC5F9DE71B7683D 018D86
Columns 4865-5120	A6CDFD8D8117748A4B41C3F5A66765495711EDC02F9581F3E7C2E0FD90 04B03B
Columns 5121-5376	77D0EF5DE2ACACA2A4371A5B111B877D0EDDF83C3341A5AA51261FA 4B5A0D7EA
Columns 5377-5632	7C563512A6B73B3B43F8D1D113D751D6B2CABBC350FF0F8C29361DCE5 EB87C8F
Columns 5633-5888	F6DFA5C672C2517931371ACB6462A596D41419CD4F0F84EFF98DCBBE6 10AE03E
Columns 5889-6144	05FF840FB320DD5C3FB4FE4A5858510914A5161B2AD3C3E7FD02358505 190F0F
Row 769	
Columns 4097-4352	5B6D534EDE13068A2459CB07007121B0F07B08B8227047C1A629DCA5A4 E30D28
Columns 4353-4608	5D00E72E5B6AD57A9F0F9E0608702BDE8BDBFA371C06D96BFE0E60377 5A875CB
Columns 4609-4864	692EB7DA76BD0D4AFE92FCB5B5184BAA3EEE37900144CA03B7A22EA DE2F061FF
Columns 4865-5120	B3CDE2464AF1212979A99380340974A9F85478E5A2E8B907E74EEFA4CB 7625E5
Columns 5121-5376	41AF736E0AA1416EA676E43CF5DFF372CFFC30D6C0A58A333268136A30 20033F
Columns 5377-5632	F50111382FEBA594C255896AB59C06638406956F19B67F80A3A7276060D4 E7F6
Columns 5633-5888	DCB75287BE9A2620A1F594570B269097A51A32548BAA6DD9B429B8AAF 992C8C0
Columns 5889-6144	6210A36B63DE9C732339DC1AFA94CAB475574A6D1C4D0C17F148B8AD 12816B47
Row 1025	
Columns 4097-4352	E24D7C17BCC46297EDC41AA9B5C9D93689843027C6A78449F8D151E1F4 2BE98F
Columns 4353-4608	4544BD9E6975DDD4BC9B3EFAD50AFC582CAE269677B130FED2C39D5E BDEE56B8
Columns 4609-4864	6A13BB53C03B0C8A4E0D1697322A1A3055054229A69B6CCB7E1FB0B88 5B90CD2

Columns 4865-5120	BE5C66B252E5C51D7D9E9E25922566C18F0234F2A330041AEC6A4F2729 A2A30B
Columns 5121-5376	1E04A65CF0BA05C62B15FEF9967ECD975EC43C035DE4EE6422237F5683 4AC746
Columns 5377-5632	4FD0C1AF8A61F56686326F93EF63E2C114D55726A5F74BFD99AE7713DF 2DE6CF
Columns 5633-5888	A9CC4B50995A682C6F6F12C80929FF208C72007D6A253FD36DE363E8EB F2B614
Columns 5889-6144	95F6F59DA4CE4BA4D6D4D371A2484F16EFA33CD34F71B81702F0E99C0 31B089D
Row 1281	
Columns 4097-4352	E16A7B75AB838252D1840EF2935AA1CCA5C8470F98202BABA93EEACE 43EE56E1
Columns 4353-4608	B2D767F35B0F34FCE855B53B6B8DB8DD08BCF47684E904FA47965D7210 7897D1
Columns 4609-4864	3D38403A0D2696A767679C6F9CC37537A93A125CE7041EC4F39AD74525 97ED13
Columns 4865-5120	A0CCD841B7CA93DB6F7039B929A820F55A95AA3786C96E0434DA46A08 4653B1A
Columns 5121-5376	08A907831A27892D0DD5B6C9FCB5229C0C03663794A4E94E3FB22E4068 ED0EE8
Columns 5377-5632	53BCBD15AA8DEC3451CEF53541B04056E4DCA0393836E9B6DFCF9B01 E901D933
Columns 5633-5888	BD160166307B70BE5618C6E0B4ADEBA46F65C69080D4C3FAADF1AA22 911C2C69
Columns 5889-6144	42FB1575074655ABD1EFF5784CBE7FA0B110981C8A0BDF01C650189C2D C9FC74
Row 1537	
Columns 4097-4352	B403563011DDE16F92630CF312B3F7F495E74B3B582DFB9401F509A35BD 2528C
Columns 4353-4608	A81600F6437FBD00FCF0E4AD41DE3598434EE3903CD1A17CF618E8E2A4 7EBC4C
Columns 4609-4864	A1D7816AE33BA46E3A9D5B3CBDACF93D538802ED0FCCEFF193DB9D6 B79C7E508
Columns 4865-5120	54B42DDFAA7DE9B5299F4C1B5DA05487562D20349282F7061E3159E4EA B09D03
Columns 5121-5376	E15D45F2D1694FF3FF1AA1FC1E58E3FBD6875B71B982AD57AC96CD3B7 BE8ACC6
Columns 5377-5632	90CADDAD41374E4BCA29AAB22CAD61989158C474E0725B4C4C5442D6 A12D94D8
Columns 5633-5888	2827752CE49CB9C385AD35C1291109892EF85A7A6C043BD8E3BA4AC3D 5146FB7
Columns 5889-6144	87002794AC4020B7D229EAE70E01E72F1772B0DA401ABE2C2D487EF607 24DC83

Row 1793	
Columns 4097-4352	413A0F58974C76AB4C17AB24F37CB1055FC1827A1DDB0456CCAA7F9477CA64FC
Columns 4353-4608	904E1D9338D0795C6844F79ED8B26A9D306F66975CE704A925E72EC95509188B
Columns 4609-4864	2B5EC3212ADF35954F1CDA9CB6CCC28E422F23AF81659F6E4AFDD03E FB8AD730
Columns 4865-5120	84D1CCA3B5036F031EEDE0F1121E6F62D232DFB74A0582EB3303D1E988 10A6C9
Columns 5121-5376	221F0EFC A2C81259B57F8E6943D0CD36088A64DA7FE2E6E7E0F63EAF87 3B8A79
Columns 5377-5632	57E9B39245C6173088B024F34ED7B64F8784413FF95E476474FECDAE7BD 62E5A
Columns 5633-5888	807A807832F6AC83BC7CA7F754BBC7DE72CCC85425068F50ED52419643 561832
Columns 5889-6144	1B9CF54C055FB01B40740A0D469855292AE8A0C58756BDD3C6DABE268 551FD5F
Row 2049	
Columns 4097-4352	DD8CE660B7403DC8672EA620E65301B0865A23FE568C173669EE1D7F7A 1BD748
Columns 4353-4608	3CCFAC84AB188D906D70525D092C3E2B46C6675C1CF4B30AB346022E4 3DA20B8
Columns 4609-4864	A01DC1159652EA260B411971B0E3D0393C1E75AB0EA462E1D07D0847EF A9CFBA
Columns 4865-5120	4153E6B4F4687D434414BAA200FA38CE46B28D3B4055C633AAD0ED2FA CD6B415
Columns 5121-5376	5234FA7B72F478A193EC14698C611F3CB70BF72C15E0DCE9CC048A526A C1F46A
Columns 5377-5632	969C10820390DF8D90AD0138202A32182398B70405520538D08C1F799FBC 0755
Columns 5633-5888	53D8304A8B5213FF88DD1620B1A5125AF1CC9A07F95C61C5C6C625F64F FCDBE6
Columns 5889-6144	ED1E06EC959FF323FD3E8AF3553D90BD529D699B08B873F164F59B1CD5 22AC0F
Row 2305	
Columns 4097-4352	A5C8A02849509DECECFADD4C89C03A78E1564A548D89DECD90DDBC AC7964E9F0
Columns 4353-4608	545B207877BBAFB5DED6AEAD3967CA72272E128C97B06868FD3BB8599 6640432
Columns 4609-4864	2995ED49B525D47CE868EFD6FDBB0BB6975DC82C8580D00ABC9FFC6 F532A0CB
Columns 4865-5120	9F0B1EC3BC16C2E7C94F5149D03677AD039452180B24DA434F5BBAA0B CEE64ED
Columns 5121-5376	910009CE6C11178F5BC794754EBA72003E9A53CDA988B33CE2D0A0965D AACAA23



Columns 5377-5632	BF8A7AE5330F4813AE7F8E4F25666EAB3F0351BD34ABBFA8874D88D5F C4E9385
Columns 5633-5888	45A0C20F7DFD392872ABDCB19E4F6F097044266B9EA6F0B318A5011D0E 51E735
Columns 5889-6144	EE58F5FC44AE859564B64F3D173C58FAE938AFB934CBB97245F7B1A1D DD4C559
Row 2561	
Columns 4097-4352	C7DF1E821B249BE35E6CAB842F3DFCD0141E428141C28BDCF54B09853 29F6E2A
Columns 4353-4608	D8C083075232BDEADEA797B6C9E15606A72B8B48502B1C044BA89A8D BC54EB6E
Columns 4609-4864	718EF66E726EA72E631B9B22E193F012F3FB2D112468B0DB89F0C3C8A14 3E9B1
Columns 4865-5120	7D6BE8EA6A522A10F46EC5A56E3F572586884547536AFFAD0C82A42D88 AAA64B
Columns 5121-5376	0B740E17EEF10A800DE1916C291C1535845114313E908D313B58018EB77 DED61
Columns 5377-5632	9A5F7429731308EFAB68D1725D8F9501234F9035869415A62262095D77A9 613A
Columns 5633-5888	9BDCBC26ABDE4672BE5F130E1089BE8BF5CA0ED3FCD9F28B75CC07E9 822AA2EF
Columns 5889-6144	6AC735D6621C86CEA203E9E1FC993207EDC164396C7C8FF227F92979A3 13914D
Row 2817	
Columns 4097-4352	8E1D4E308C03F66D73D76A715F859BEDBC8D709D4BEFC1558D74B4986 0A90ABA
Columns 4353-4608	B67C75041BFB3A61BBBB73DE2B3D7BB5CB254F10257495E3185C71C35 59D9CD0
Columns 4609-4864	ACB7A163EB1E088624F946909B29B2C7373C5CF4F6B1F3A75DC49B1574 B3AAB8
Columns 4865-5120	327C55142CE3D1382EA917A7C6730E01BA6BA43767D53E84FFB7D61D6 EAD24AD
Columns 5121-5376	CFAAC26024A1D642C795400B8646533A435A4FE899704FAFAE2BF452B D9AF093
Columns 5377-5632	53759538B5F4A8614F1AB4840CFC1EFD8CAFCB067C991FDF2658ABA23 F8B0B93
Columns 5633-5888	6B3A35CDECD26C58B9F1318AF46F13767758FC0F74B7DD050A9B1A1C7 F98B930
Columns 5889-6144	4B4C20D040F3A8C746453ECE10C0A1F4F74BDDDB1A8FCFE1DE2C19148 A5E88F1C
Row 3073	
Columns 4097-4352	A98B4DE68DDB2434893BEF8F2CF8DB584CEE8F0E39D30CD4C87017E7E E6886F8
Columns 4353-4608	23024E83F777D7DF0D7E46A8B5F9B1331D0BC2F79BF5559C3241D5BDC7 E7A665

Columns 4609-4864	9E1DD50373C16CC97A5E390921B471EF5B39731CCC2CBDD08876080680 F9D974
Columns 4865-5120	9DF22EE3AB758F85FD490012FCFF20B3329A5648D25859036C0586C65F4 6236C
Columns 5121-5376	B009BA2650ABAF45653D61D2BFA255DE767D0B25AC7736E8E5200D21 EE3E28F
Columns 5377-5632	FD96F63D0A22CD574ED61899ECDEB4BEB333F994AC7791FF89EC600B8 57D4DDD
Columns 5633-5888	C2773C7DCE36709F70180CFFAE22AD44A4A20211224F8ECFB336A54A68 1A1F59
Columns 5889-6144	5C00C419C78A79ADA49562EFB784ECE44BAF45C1E75BD84DE7C1C6910 0F8B93A
Row 3329	
Columns 4097-4352	DAB0C7C65F0D096351BF8A0EE9CEF5F7756A9A47B4EE80420DEFA16B0 E74CF18
Columns 4353-4608	0FAB86E762595261852E38F9D797D4F796DA18169AFAC99E8235D4DD6C 2BB887
Columns 4609-4864	15D0F65E9ADB2C67A887E5D8EF4E1080AC968F4C0D673CA7A74759A7F 1B4E383
Columns 4865-5120	1B5641CE5FADE005EB947BE5E20E7DDAF6372655825B3516F2EC5B36D 687895F
Columns 5121-5376	2C0BB35E3C3EDA32C19BFF6F3A2397A8E25C646059359D90A1372FCAE E250A43
Columns 5377-5632	8AABBF162C4499F2FECFA27F8D7582FB607B88D04F4A6100A3D2F8A88 A2E5E80
Columns 5633-5888	D9C26C2A023943BC62F3C18658A0F5C64130BFF0D74BBB85EBFFFE197 C94C6EC
Columns 5889-6144	0AED385393F69FA9F7E69DDC061B85E4E77D0BE2013061E94A0DB8AC2 995096F
Row 3585	
Columns 4097-4352	775369B59AA940DA96B47429C339536B51ECC59C60BAD762FA275A6A8 F90885A
Columns 4353-4608	922A84AE2B06B4003C0A7BE22FB211365376C3FBFC03EB0DEA264F6769 B57EE2
Columns 4609-4864	E518ED3DD8553DC8815E57F23DADC1A3E99030AA02A3529604EE4BD66 D770F8E
Columns 4865-5120	8AB3C94077F85772647897A76CFE4EC56FCAA7A28968065CC73BDD88A DA4D60C
Columns 5121-5376	9430F05CFEF8ACBBA73038463A9AD3BDE5BA4E94FDA81C6C51AB3C6 9201906E1
Columns 5377-5632	2613EFCF235670383ED865C6161C8A8958DC09289EA03658376277BE6E4 E62AA
Columns 5633-5888	3C90B273B9870A069FE0F5164AA8F837B9905EEE7D3AEB794BA2F4CAA 4F1EB01

Columns 5889-6144	01C2973BD37D564B7D21243A206BD8A7B435428BA8DD3DB7045541BCC E000F5F
Row 3841	
Columns 4097-4352	CEA89305914BEB1BE84B59A4A18CC1AEB5CC96326ADC69F3B4957198 C60BB6E7
Columns 4353-4608	DB38C42E2947EFC39D2BBFA07C18C320A22C7B9C6CBFB72E6909BDC1 31B2E15E
Columns 4609-4864	ABECA69DD1395554C852ED7EE6817A6152B39B42F6D7D56B781D1803B 8307C79
Columns 4865-5120	386FFC16B79E309255E7D5933870D116DE3828C68348493D8E288C8A3FB F741F
Columns 5121-5376	0936252D32CDEC49ACFE91F2BA885044E0A9ADFEA526F53641F97B8666 8C5972
Columns 5377-5632	F9D8560A97AFA4282DBCC4250B75A871276434FFA80959F04D3400D819 37617D
Columns 5633-5888	799C3EDF3F1345908B306D8372A740E96707761FCCA9B861402134AE948 8387F
Columns 5889-6144	F2DA86FE2BAA7E675DFDED45499AF1B40AE292B1DE6B7A7D4799C3B 88177704D

D.4.e. Code Rate =4/5, Information Block Size = 1024,  $M = 128$ 

The first 1024 columns of  $\mathbf{G}$  form a  $1024 \times 1024$  identity matrix and the remaining 256 columns of  $\mathbf{G}$  form a block matrix composed of 32 rows and 8 columns of circulant matrices, each of size  $32 \times 32$ . The first row of each circulant is given in hexadecimal format in [Table D-8](#) according to its location in  $\mathbf{G}$ . Subsequent rows of each circulant can be computed by applying the corresponding number of right circular shifts to the first row.

<b>Table D-8. First Rows of Circulants in Generator Matrix, <math>r=4/5</math>, <math>k=1024</math></b>	
Row 1	
Columns 1025-1056	678ECB51
Columns 1057-1088	FE821D5C
Columns 1089-1120	FA5F424B
Columns 1121-1152	F55927AA
Columns 1153-1184	3E826913
Columns 1185-1216	32E04B0C
Columns 1217-1248	4F88862B
Columns 1249-1280	803432EF
Row 33	
Columns 1025-1056	42B27625
Columns 1057-1088	9F8DA1E1
Columns 1089-1120	F8472D1B
Columns 1121-1152	D943D394
Columns 1153-1184	29261575

Columns 1185-1216	BA434C68
Columns 1217-1248	18EF349A
Columns 1249-1280	27CA1CC4
Row 65	
Columns 1025-1056	EC900397
Columns 1057-1088	64A4A063
Columns 1089-1120	9BCEC4A6
Columns 1121-1152	D05BA70F
Columns 1153-1184	E7155BE1
Columns 1185-1216	7FF09CC1
Columns 1217-1248	6E2E2059
Columns 1249-1280	7F1567E5
Row 97	
Columns 1025-1056	5616101C
Columns 1057-1088	EA060E2B
Columns 1089-1120	B673068B
Columns 1121-1152	923BDF8B
Columns 1153-1184	B9B9343D
Columns 1185-1216	049C63A8
Columns 1217-1248	333E9CFE
Columns 1249-1280	809B362D
Row 129	
Columns 1025-1056	9D41634C
Columns 1057-1088	404E17DA
Columns 1089-1120	3B4161F2
Columns 1121-1152	5235992E
Columns 1153-1184	EA4B4B8B
Columns 1185-1216	4690BCE1
Columns 1217-1248	F9DA36A1
Columns 1249-1280	16439BB1
Row 161	
Columns 1025-1056	5D7254B5
Columns 1057-1088	15B4978B
Columns 1089-1120	00D05224
Columns 1121-1152	107BD904
Columns 1153-1184	C85D7E58
Columns 1185-1216	0451F1A5
Columns 1217-1248	EE9D1897
Columns 1249-1280	913DA6F9
Row 193	
Columns 1025-1056	42819F61
Columns 1057-1088	343773CA
Columns 1089-1120	11A6492A
Columns 1121-1152	4832F43F

Columns 1153-1184	849C11ED
Columns 1185-1216	F0FE864F
Columns 1217-1248	CC270400
Columns 1249-1280	9726D66E
Row 225	
Columns 1025-1056	89EE2A44
Columns 1057-1088	685C1F67
Columns 1089-1120	1DF6E416
Columns 1121-1152	507BF2EF
Columns 1153-1184	8759C2FB
Columns 1185-1216	52162ABF
Columns 1217-1248	2B61D3FB
Columns 1249-1280	988708C4
Row 257	
Columns 1025-1056	4A8FEA09
Columns 1057-1088	53452354
Columns 1089-1120	A33E2E73
Columns 1121-1152	271E8211
Columns 1153-1184	16DF62E5
Columns 1185-1216	03DF81F4
Columns 1217-1248	8848BD0F
Columns 1249-1280	F95DF357
Row 289	
Columns 1025-1056	9BE0A7B3
Columns 1057-1088	617256EB
Columns 1089-1120	9A4D0BB4
Columns 1121-1152	FE3A3A19
Columns 1153-1184	FAA63D9E
Columns 1185-1216	65328918
Columns 1217-1248	D699BA35
Columns 1249-1280	4CDE6FE0
Row 321	
Columns 1025-1056	848B1FE5
Columns 1057-1088	0AB58A6F
Columns 1089-1120	341707F1
Columns 1121-1152	EF36474B
Columns 1153-1184	F623A7A5
Columns 1185-1216	A35EC9BA
Columns 1217-1248	24909B6E
Columns 1249-1280	64A7A898
Row 353	
Columns 1025-1056	BDDF3BAE
Columns 1057-1088	7202FA26
Columns 1089-1120	86F90C57

Columns 1121-1152	A0399F20
Columns 1153-1184	972B9A31
Columns 1185-1216	87B245AE
Columns 1217-1248	E0C5A338
Columns 1249-1280	4959AAD9
Row 385	
Columns 1025-1056	CF726C27
Columns 1057-1088	7B38429A
Columns 1089-1120	BA37C244
Columns 1121-1152	EE7717DB
Columns 1153-1184	E45C99CA
Columns 1185-1216	7E3E013B
Columns 1217-1248	7B800CA4
Columns 1249-1280	6527F2E7
Row 417	
Columns 1025-1056	75C63782
Columns 1057-1088	1CC40137
Columns 1089-1120	51E69F16
Columns 1121-1152	414B155F
Columns 1153-1184	DF1964DE
Columns 1185-1216	F13C71F7
Columns 1217-1248	6E9E8044
Columns 1249-1280	6C5CEC86
Row 449	
Columns 1025-1056	6F2A6DF8
Columns 1057-1088	9FF2BF82
Columns 1089-1120	D3625355
Columns 1121-1152	24466981
Columns 1153-1184	D5F14AC1
Columns 1185-1216	E1C24AEA
Columns 1217-1248	A8850D83
Columns 1249-1280	7A3C5120
Row 481	
Columns 1025-1056	BAABADC3
Columns 1057-1088	1ECF066D
Columns 1089-1120	76538348
Columns 1121-1152	FC5D4D54
Columns 1153-1184	43AD46CF
Columns 1185-1216	3342012C
Columns 1217-1248	63EBE2DC
Columns 1249-1280	D832EF8E
Row 513	
Columns 1025-1056	E6EC82F1
Columns 1057-1088	4AAFE782

Columns 1089-1120	14D89E38
Columns 1121-1152	23C83402
Columns 1153-1184	8B48D6BF
Columns 1185-1216	C823B89A
Columns 1217-1248	68A35626
Columns 1249-1280	E89FE121
Row 545	
Columns 1025-1056	4BBAA331
Columns 1057-1088	20EC16C9
Columns 1089-1120	6ADABE06
Columns 1121-1152	D803DA6D
Columns 1153-1184	FCC89D41
Columns 1185-1216	E57B10E8
Columns 1217-1248	CC3FF014
Columns 1249-1280	4DB74206
Row 577	
Columns 1025-1056	503FD586
Columns 1057-1088	52F68B91
Columns 1089-1120	97D69DF3
Columns 1121-1152	129C764E
Columns 1153-1184	8B2143F7
Columns 1185-1216	A36EF3BA
Columns 1217-1248	7C27896C
Columns 1249-1280	560F67B5
Row 609	
Columns 1025-1056	D70390E6
Columns 1057-1088	98B337EA
Columns 1089-1120	89568363
Columns 1121-1152	2A1681DF
Columns 1153-1184	4B4E928C
Columns 1185-1216	41EC3D9C
Columns 1217-1248	DFD92EB2
Columns 1249-1280	A5D5C85C
Row 641	
Columns 1025-1056	2A5088BD
Columns 1057-1088	76CB6810
Columns 1089-1120	CB693D21
Columns 1121-1152	C0E9EFD5
Columns 1153-1184	F992506E
Columns 1185-1216	299CE082
Columns 1217-1248	901155A6
Columns 1249-1280	0B93AA16
Row 673	
Columns 1025-1056	18FEFECE

Columns 1057-1088	B0063536
Columns 1089-1120	95487089
Columns 1121-1152	4BB31BB9
Columns 1153-1184	66F3FD97
Columns 1185-1216	E32B58A0
Columns 1217-1248	2A39427A
Columns 1249-1280	5CD8DE9F
Row 705	
Columns 1025-1056	1A8F8616
Columns 1057-1088	C5F7D2B2
Columns 1089-1120	5AD2BC4E
Columns 1121-1152	BF1E86DB
Columns 1153-1184	ACF7BFFA
Columns 1185-1216	F3589597
Columns 1217-1248	A777654C
Columns 1249-1280	12DD1364
Row 737	
Columns 1025-1056	FFC03A59
Columns 1057-1088	DC450527
Columns 1089-1120	33B4C871
Columns 1121-1152	BAA2EA33
Columns 1153-1184	93A751A6
Columns 1185-1216	F9D72E4D
Columns 1217-1248	69B50C7F
Columns 1249-1280	F74151F9
Row 769	
Columns 1025-1056	7BE8519D
Columns 1057-1088	AF6FFAFA
Columns 1089-1120	268DBA73
Columns 1121-1152	A356128C
Columns 1153-1184	0418BE2C
Columns 1185-1216	1A43465A
Columns 1217-1248	60C6DF65
Columns 1249-1280	0E2438A0
Row 801	
Columns 1025-1056	EC25DC05
Columns 1057-1088	66AEE4A8
Columns 1089-1120	A72A030A
Columns 1121-1152	B11FB610
Columns 1153-1184	DD74DAF7
Columns 1185-1216	62F6D565
Columns 1217-1248	554EAEB7
Columns 1249-1280	15F7AE6C



Row 833	
Columns 1025-1056	5147F90A
Columns 1057-1088	FF0EEC01
Columns 1089-1120	12A9966C
Columns 1121-1152	871705B1
Columns 1153-1184	E935FF30
Columns 1185-1216	46E32957
Columns 1217-1248	546D69FC
Columns 1249-1280	B8A1BD06
Row 865	
Columns 1025-1056	6A80EA6F
Columns 1057-1088	71A29506
Columns 1089-1120	EF78AACF
Columns 1121-1152	8D52B5ED
Columns 1153-1184	9F0A4966
Columns 1185-1216	61B3B68E
Columns 1217-1248	4B17AF96
Columns 1249-1280	5B282C2E
Row 897	
Columns 1025-1056	75582272
Columns 1057-1088	16E54299
Columns 1089-1120	7D070B9C
Columns 1121-1152	AB130157
Columns 1153-1184	76C619D2
Columns 1185-1216	5500E2D5
Columns 1217-1248	1F980459
Columns 1249-1280	5D9C7F83
Row 929	
Columns 1025-1056	6A0DDA1D
Columns 1057-1088	F6E8B610
Columns 1089-1120	25D0E0A1
Columns 1121-1152	242749E0
Columns 1153-1184	FEDA4A06
Columns 1185-1216	072D69D6
Columns 1217-1248	03C7DA79
Columns 1249-1280	51AA3355
Row 961	
Columns 1025-1056	6E9FEFF0
Columns 1057-1088	0797CBF1
Columns 1089-1120	E936C824
Columns 1121-1152	C9C1EAF5
Columns 1153-1184	D4607E46
Columns 1185-1216	88ED7B0E
Columns 1217-1248	92E160AD

Columns 1249-1280	731140AD
Row 993	
Columns 1025-1056	32FEFCAF
Columns 1057-1088	70863B75
Columns 1089-1120	3846F110
Columns 1121-1152	C4E23DFE
Columns 1153-1184	79D3F753
Columns 1185-1216	064648FA
Columns 1217-1248	830452F5
Columns 1249-1280	B9ED8445

D.4.f. Code Rate =4/5, Information Block Size = 4096, M = 512

The first 4096 columns of **G** form a  $4096 \times 4096$  identity matrix and the remaining 1024 columns of **G** form a block matrix composed of 32 rows and 8 columns of circulant matrices, each of size  $128 \times 128$ . The first row of each circulant is given in hexadecimal format in [Table D-9](#) according to its location in **G**. Subsequent rows of each circulant can be computed by applying the corresponding number of right circular shifts to the first row.

<b>Table D-9. First Rows of Circulants in Generator Matrix, r=4/5, k=4096</b>	
Row 1	
Columns 4097-4224	473BC533A12C3596F642673D0DBF1142
Columns 4225-4352	079A3868E1A6F556F0DF3DCA4493AE54
Columns 4353-4480	AE4C50F12AEF6EEDEA9BB30605F4A24C
Columns 4481-4608	B0B2B4B9035331ABF53DE4752E7EDABF
Columns 4609-4736	E7E08EF3E22EE7EFE645E9E59507A206
Columns 4737-4864	52E4A2C06270B2D1A418134BC0D58678
Columns 4865-4992	0A84E53303F4092DB47056AD3C0847AD
Columns 4993-5120	2DEF73813B17101E79A3A58A7E91C4E2
Row 129	
Columns 4097-4224	667AA815610234DBA0FFA951CABB8BA7
Columns 4225-4352	A3271642E4BCDD24F8D89BD783317ABB
Columns 4353-4480	CC64FA95F06AE45C7E38935D78BF5F80
Columns 4481-4608	510CE9ABC6156F008B317C79E0122B09
Columns 4609-4736	3CB09E20016A5F93E207C144E889F3B9
Columns 4737-4864	AE6185E4345C5971E03AD499EF850D33
Columns 4865-4992	FA8B392CE78B5712290CB2F518F3E0CC
Columns 4993-5120	429C39F0915EB60CA0545B6AB2967149
Row 257	
Columns 4097-4224	FE9FF6C26898CB926F9BCD129AA52083
Columns 4225-4352	3FC159DB58B64D39CB27847434F177E2
Columns 4353-4480	E040D71365D96A1D54FD20051D3A50E7
Columns 4481-4608	E8AC736B6D2BB5468F8F68DDF5789C2F
Columns 4609-4736	4954E4153CFF0F52F8F8F5B243A03E2B

Columns 4737-4864	99A1DDD23204D103E323158E0FEE7673
Columns 4865-4992	43C2A07046BA1B4307BA6CEC7D740CFE
Columns 4993-5120	CB4E113F94C6CAA4652EFD867B43D199
Row 385	
Columns 4097-4224	081E779BF01F34C97337A3ABC8698644
Columns 4225-4352	9C9E794155E27547283C1AB2706A388D
Columns 4353-4480	FB9DFD194731EC2AE99EA6B641B309A2
Columns 4481-4608	258D45A1BBEAFFC787E61289A54A2473
Columns 4609-4736	FDF3E96C7679E979911C4BE65A333250
Columns 4737-4864	178259F846AA95577C2EC448EE709423
Columns 4865-4992	A61BE7CCED0342965CA234AF02914916
Columns 4993-5120	E045B3C585714F272D40C8085AE5E8F4
Row 513	
Columns 4097-4224	7FB352B26E544BDC18D76B323C3CE1BB
Columns 4225-4352	8421967EE08A6F719B675F06F13FF05B
Columns 4353-4480	672C29DC5B80E18E2F4C42D0F6D5D6D4
Columns 4481-4608	7DE072F73A8015862A275B2CEA2FFC1C
Columns 4609-4736	284B87ABA22362D98952442BBDFBF4A3
Columns 4737-4864	2B798BCD5D8C0B02BBE5DE4A96569F99
Columns 4865-4992	409E72F4138595F8B3C14074BD8E33E0
Columns 4993-5120	3B07838358BBAE631C8258D6B07D2E1C
Row 641	
Columns 4097-4224	403149A1C88E4D4893FE719B2638B7FF
Columns 4225-4352	9886F3E90FC018699F3B39183F2219DC
Columns 4353-4480	F5B0D3AA451225867913FF8FF979BBE0
Columns 4481-4608	795DFCBCC98210C028FD21380EBDDABF
Columns 4609-4736	0BBE0D91FA504DC4DC8848AEA001577F
Columns 4737-4864	51653E755F6CB4F75ACE347EC899304D
Columns 4865-4992	1D0EE239D8A6C2E2EA13D4CFB3394FCA
Columns 4993-5120	BF707E3ACD882B91FDDD44A7EA0D1F3D
Row 769	
Columns 4097-4224	14EB386A5A4524983682993353F8D76E
Columns 4225-4352	F9850534D2FB4F19F787897435C5EB0F
Columns 4353-4480	B680840F8D34A0995BA0A94E309A9194
Columns 4481-4608	6C66CAA0567BFFD609B6484BCD477702
Columns 4609-4736	B62A4053A6916719693D50608EC1D717
Columns 4737-4864	23C38E6F64963EE836ADC6BBF39F4CD1
Columns 4865-4992	A40947C16AEAD43F621457BDB766A157
Columns 4993-5120	DD6118ACF503356D0B3479828C296016
Row 897	
Columns 4097-4224	AAB1061EC9FA6BA21E81D7E22D3A7ED2
Columns 4225-4352	F902B6C336258F5B6B54628AC96116DE
Columns 4353-4480	5968E3167BB1E221714B0F4B3B9D7E0A
Columns 4481-4608	F12374361559D0F0E0C7FCC959B1A9D8

Columns 4609-4736	C103B779B3A769AA8D955160E4B9F9B7
Columns 4737-4864	231B28E0B7490C8EB883F29AF6CC4F12
Columns 4865-4992	A7D1FA32F82AAF128FBC6AC53532AB89
Columns 4993-5120	17AC06392CDAC681817D2F5475016296
Row 1025	
Columns 4097-4224	434D8612F27169A49ED244393B87DB5E
Columns 4225-4352	B66D806A5A9ADF46D83C7DCFDB4B72CA
Columns 4353-4480	A78E0C64307885C6E67C870BD21EC431
Columns 4481-4608	11B79B0BB0B977D9792535C16AA7D982
Columns 4609-4736	B597FD60982B8C42D019390EFA14B3D5
Columns 4737-4864	C57FF5CFA1C438AC576782A5B48B78AA
Columns 4865-4992	AE278E95DA048F720B7DB5FB6488287B
Columns 4993-5120	893C7E7E8DCB6E5ED5DB819D8901B32C
Row 1153	
Columns 4097-4224	B7BA8906FC3AEADE22254872ECA99117
Columns 4225-4352	74F39404FA2779F4C55D649E5A6AA628
Columns 4353-4480	4A1F8910EBF76F2F4E3EF686266CEBB8
Columns 4481-4608	8363A57CF1377C68419BEFE6C848FEDA
Columns 4609-4736	8F141154BFA88D31446EF367ED965F98
Columns 4737-4864	1242B3F840426E98010B84A957090390
Columns 4865-4992	9CE9E0B619E61C4A481F1DD44360BCAC
Columns 4993-5120	0938AE511B2B47A42F5F59FBF547D991
Row 1281	
Columns 4097-4224	85B68FFC07A32A495D9A708FAECD2C41
Columns 4225-4352	69CFDFFD21D6B2CF3F91CF5820823B83
Columns 4353-4480	7D62406050908C82C21CF32B862166F2
Columns 4481-4608	82AF2DF8E6CADB5D043FBF863ACE6599
Columns 4609-4736	700097EE5FDDD825468C544985C983CE
Columns 4737-4864	69EE0178288A8E1A12009EBF2E4382DE
Columns 4865-4992	2B8D59DE631991AE1B67C70786B43BE2
Columns 4993-5120	860FC3354C9FE4253EBF307D1C643E22
Row 1409	
Columns 4097-4224	905330D76B16340120BB399A08061CBE
Columns 4225-4352	9D5765CE993D7092A8150DE46D6CA810
Columns 4353-4480	E03534D4DA2B66A0BF2AEF3B833E18DF
Columns 4481-4608	6C1C0D9EAB1E26FD2481F6BB6AB674C6
Columns 4609-4736	D98BD8D3FC0E0557352CF52EEA654A92
Columns 4737-4864	0DF8D4B0FD41AD3EE547119C2446F840
Columns 4865-4992	4C1F458D1E2F4B70D9023F0DFC06EFE9
Columns 4993-5120	24349C5D9DE2B048DC74D3E888043526
Row 1537	
Columns 4097-4224	E864E5EE002EB3B4C31A8D3B3E22D2C6
Columns 4225-4352	B3C4136542237F8E3C75AA228AB1B2F5
Columns 4353-4480	43DF20DF407EAC80CAF22FDDADD586C9

Columns 4481-4608	9414219FF80742652531AC5CC0E52866
Columns 4609-4736	1A68E6BC5CA7FCA386396D0F56A2E7A3
Columns 4737-4864	D9EC25B8DEA08EDB6A9E6CFFEC7B15C1
Columns 4865-4992	CD48176480B2E0FED349142BE9888043
Columns 4993-5120	9A70BAD89B53A4461301DF6C1763EB67
Row 1665	
Columns 4097-4224	5C9B0F852875D4B06EFA7FF418710592
Columns 4225-4352	6F7C0712083341F6A97F398A275243DC
Columns 4353-4480	3D046D9B0B0B6AB3FEB99F72A70BAF35
Columns 4481-4608	50F7B484C2530BEF63537B68EBDCF01C
Columns 4609-4736	672E8B1DD956431036302F8557CBB4E0
Columns 4737-4864	C9CAD206AB0AD88C655E0F52C70AEEA1
Columns 4865-4992	FF7EC97F9439C9D4CD71487F10065DE0
Columns 4993-5120	532339617D706AEFA50A23B90B57978C
Row 1793	
Columns 4097-4224	B7E0C9A5F3EF66B9ABA49150144FCBEF
Columns 4225-4352	2C9E63DC18BE8ADDA0FD7E7E8F7FC5FE
Columns 4353-4480	5C55C60E14C3D7AC4D00D9F6C827E1EC
Columns 4481-4608	4E40D57E1740089DB1248707D195C038
Columns 4609-4736	4500AD976DD321E6133113D244711330
Columns 4737-4864	0260379D0A20D10A899019157631007D
Columns 4865-4992	4DF741A808694A9956E493B4668B67FD
Columns 4993-5120	F89442CABAA2262C398171D62E938504
Row 1921	
Columns 4097-4224	CCF8A4E13D655D5591DC40D2C6607CEF
Columns 4225-4352	353E539A020B0C608F843A855BA9B7AE
Columns 4353-4480	CD31CCCB9388FECDEBEE1CCF42943E77
Columns 4481-4608	9CA39E64D8AC9E23F15A0CB4C73ACB80
Columns 4609-4736	3BF0F0DA9576923D95089979081ACA77
Columns 4737-4864	359B090725B62278F00D0222CAD4C0FF
Columns 4865-4992	4ABA29056D55C5AAD990AA10A9A1A9B2
Columns 4993-5120	27A09750826682C157BD7CD2178FDC96
Row 2049	
Columns 4097-4224	AFC3076AF8AFB82B45FE8F2628F489F1
Columns 4225-4352	2CFA95663A96A30FB3831F756D9E666A
Columns 4353-4480	011EE24F6C5EE283C3EE09A1D5FAF1B9
Columns 4481-4608	7B49CB7B94EDEB207221A9436E1FFDF5
Columns 4609-4736	5D36302EEBDD74AD27158F4D9DF0FA6E
Columns 4737-4864	497015959B333E79885FBE22B9B72707
Columns 4865-4992	E330EEAD520B31BAD1A5DC55EF54193A
Columns 4993-5120	D6C112F89677E27A26F1DC62E08DF49C
Row 2177	
Columns 4097-4224	2DF5B0291E619A18D802502086037C46
Columns 4225-4352	730D20AE9364A6AD090B789D8AA6C6CC

Columns 4353-4480	EA476A585503E90BCAAD943DD30E1BCC
Columns 4481-4608	1D5C236ED01E9E5C8E94E96FA7252ABF
Columns 4609-4736	3EB2DB84FB4837EA5153CA825D11F86B
Columns 4737-4864	574E63C92DD0E75AD8DDFF2B37CC97C9
Columns 4865-4992	5E83299E60C44293BF0824C62EB7980C
Columns 4993-5120	5678B852002834EB2D630EAC536FFB78
Row 2305	
Columns 4097-4224	9A41F048C1C68187734BFB916EC3BFAF
Columns 4225-4352	4B23BDA1162B30CB7AEA9F03BEBCF597
Columns 4353-4480	C65460BFAF9C8913608F9888E738F4A1
Columns 4481-4608	017AEE470FCA60F9711E9BE5EB98E7C9
Columns 4609-4736	4EE8869A59EDF8BDD52C5B5388B35249
Columns 4737-4864	8EB0D25B439273CA6545E82E69D8677C
Columns 4865-4992	5B23991A53041EA4B276405C156A9DE5
Columns 4993-5120	A90889BC74530A5F87CCF024E591E18F
Row 2433	
Columns 4097-4224	22735E1E720A8B3C29A80F3696D6F157
Columns 4225-4352	F68ED2F2389D5D2CDC59D706495D815F
Columns 4353-4480	D0EE25B73218D5717572387BFA03A7C2
Columns 4481-4608	A0717B27763FE223BDA3EB0DAFBEBF276
Columns 4609-4736	9DBB8235D11298BEE28B39772ED91A35
Columns 4737-4864	92DE6FED2F6766E01DBA188153DEA205
Columns 4865-4992	48930E9A21873E62863CA15D6DB058D9
Columns 4993-5120	61A29088FE3983D0E1699EF0AAFA5FD1
Row 2561	
Columns 4097-4224	A73005690098889382252873E627D6FB
Columns 4225-4352	7862DE8A3D0F1A9387963F38A82E4703
Columns 4353-4480	78BAB9252EE72FB0C798C7C684B6E789
Columns 4481-4608	B7480D9712BFA72D122F243674AD887F
Columns 4609-4736	EC1851EB80A37133B68F0F709DB32E05
Columns 4737-4864	A809CB3638414FD6E156821BDAC256E0
Columns 4865-4992	B75342B6CFF7ED428521AB48A4C55D66
Columns 4993-5120	C9AB047D79A484289C820E8FADD87251
Row 2689	
Columns 4097-4224	A69C02525644F41D03197EF26112D606
Columns 4225-4352	3DF71AD0410035AE1AE7B0AB310B6967
Columns 4353-4480	C4F82E31B4D9B491EF8E4992FDBA61B0
Columns 4481-4608	B6B367CDE8DE0CAE22875F641288E733
Columns 4609-4736	5C142A9C7C2E259BD38D66117E9E861C
Columns 4737-4864	D27BF85E8EEE1920B57D0C62B512E2D6
Columns 4865-4992	68B4500340B7B92EDD05A44D36AC1651
Columns 4993-5120	4E77C4ABE92FE174B5D9F79070685288
Row 2817	
Columns 4097-4224	A22B2A6C9A75D7A6EEA5A0DF8A4950E2

Columns 4225-4352	24C4830123FAE1EB6EB0AC9C2D8C508E
Columns 4353-4480	1BB99D6785EBCCDD9CD6A50CF53CCA00
Columns 4481-4608	0624E36FD0817F2E198340098E60DFBF
Columns 4609-4736	A4EB92DD48085594C6F755C563F35020
Columns 4737-4864	04BDF9A2309C6E673CE08D94A45BBC4
Columns 4865-4992	8B8EC43906C28869AD4E41FB147A7696
Columns 4993-5120	8AB66E9B68FA00BEF90D3E078D0C6FFC
Row 2945	
Columns 4097-4224	89A79E9CF0BE90A3D86305B6491A49B9
Columns 4225-4352	222A27A68236765AB32D41B1E0616C83
Columns 4353-4480	99931668E57EB6378C8F4ED1C27BEDD3
Columns 4481-4608	35166846D0C673B9A8D2184C1901433A
Columns 4609-4736	4D768A5E0109B5CBC198869334D81C43
Columns 4737-4864	2C6A48CC47FD21F9608107FF80FE37AA
Columns 4865-4992	4DD3A7395630BE4B64F776C5FC6B2C31
Columns 4993-5120	4DC16B1E2B2A7F6E0E9FDAE3B60F8FAA
Row 3073	
Columns 4097-4224	CFA794F49FA5A0D88BB31D8FCA7EA8BB
Columns 4225-4352	A7AE7EE8A68580E3E922F9E13359B284
Columns 4353-4480	91F72AE8F2D6BF7830A1F83B3CDBD463
Columns 4481-4608	CE95C0EC1F609370D7E791C870229C1E
Columns 4609-4736	71EF3FDF60E2878478934DB285DEC9DC
Columns 4737-4864	0E95C103008B6BCDD2DAF85CAE732210
Columns 4865-4992	8326EE83C1FBA56FDD15B2DDB31FE7F2
Columns 4993-5120	3BA0BB43F83C67BDA1F6AEE46AEF4E62
Row 3201	
Columns 4097-4224	565083780CA89ACAA70CCFB4A888AE35
Columns 4225-4352	1210FAD0EC9602CC8C96B0A86D3996A3
Columns 4353-4480	C0B07FDDA73454C25295F72BD5004E80
Columns 4481-4608	ACCF973FC30261C990525AA0CBA006BD
Columns 4609-4736	9F079F09A405F7F87AD98429096F2A7E
Columns 4737-4864	EB8C9B13B84C06E42843A47689A9C528
Columns 4865-4992	DAAA1A175F598DCFBAD426CA43AD479
Columns 4993-5120	1BA78326E75F38EB6ED09A45303A6425
Row 3329	
Columns 4097-4224	48F42033B7B9A05149DC839C90291E98
Columns 4225-4352	9B2CEBE50A7C2C264FC6E7D674063589
Columns 4353-4480	F5B6DEAEBF72106BA9E6676564C17134
Columns 4481-4608	6D5954558D23519150AAF88D7008E634
Columns 4609-4736	1FA962FBAB864A5F867C9D6CF4E087AA
Columns 4737-4864	5D7AA674BA4B1D8CD7AE9186F1D3B23B
Columns 4865-4992	047F112791EE97B63FB7B58FF3B94E95
Columns 4993-5120	93BE39A6365C66B877AD316965A72F5B

Row 3457	
Columns 4097-4224	1B58F88E49C00DC6B35855BFF228A088
Columns 4225-4352	5C8ED47B61EEC66B5004FB6E65CBECF3
Columns 4353-4480	77789998FE80925E0237F570E04C5F5B
Columns 4481-4608	ED677661EB7FC3825AB5D5D968C0808C
Columns 4609-4736	2BDB828B19593F41671B8D0D41DF136C
Columns 4737-4864	CB47553C9B3F0EA016CC1554C35E6A7D
Columns 4865-4992	97587FEA91D2098E126EA73CC78658A6
Columns 4993-5120	ADE19711208186CA95C7417A15690C45
Row 3585	
Columns 4097-4224	BE9C169D889339D9654C976A85CFD9F7
Columns 4225-4352	47C4148E3B4712DAA3BAD1AD71873D3A
Columns 4353-4480	1CD630C342C5EBB9183ADE9BEF294E8E
Columns 4481-4608	7014C077A5F96F75BE566C866964D01C
Columns 4609-4736	E72AC43A35AD216672EBB3259B77F9BB
Columns 4737-4864	18DA8B09194FA1F0E876A080C9D6A39F
Columns 4865-4992	809B168A3D88E8E93D995CE5232C2DC2
Columns 4993-5120	C7CFA44A363F628A668D46C398CAF96F
Row 3713	
Columns 4097-4224	D57DBB24AE27ACA1716F8EA1B8AA1086
Columns 4225-4352	7B7796F4A86F1FD54C7576AD01C68953
Columns 4353-4480	E75BE799024482368F069658F7AAAFB0
Columns 4481-4608	975F3AF795E78D255871C71B4F4B77F6
Columns 4609-4736	65CD9C359BB2A82D5353E007166BDD41
Columns 4737-4864	2C5447314DB027B10B130071AD0398D1
Columns 4865-4992	DE19BC7A6BBCF6A0FF021AABF12920A5
Columns 4993-5120	58BAED484AF89E29D4DBC170CEF1D369
Row 3841	
Columns 4097-4224	4C330B2D11E15B5CB3815E09605338A6
Columns 4225-4352	75E3D1A3541E0E284F6556D68D3C8A9E
Columns 4353-4480	E5BB3B297DB62CD2907F09996967A0F4
Columns 4481-4608	FF33AEEE2C8A4A52FCCF5C39D355C39C
Columns 4609-4736	5FE5F09ABA6BCCE02A73401E5F87EAC2
Columns 4737-4864	D75702F4F57670DFA70B1C002F523EEA
Columns 4865-4992	6CE1CE2E05D420CB867EC0166B8E53A9
Columns 4993-5120	9DF9801A1C33058DD116A0AE7278BBB9
Row 3969	
Columns 4097-4224	4CF0B0C792DD8FDB3ECEAE6F2B7F663D
Columns 4225-4352	106A1C296E47C14C1498B045D57DEFB5
Columns 4353-4480	968F6D8C790263C353CF307EF90C1F21
Columns 4481-4608	66E6B632F6614E58267EF096C37718A3
Columns 4609-4736	3D46E5D10E993EB6DF81518F885EDA1B
Columns 4737-4864	6FF518FD48BB8E9DDBED4AC0F4F5EB89
Columns 4865-4992	BCC64D21A65DB379ABE2E4DC21F109FF



Columns 4993-5120	2EC0CE7B5D40973D13ECF713B01C6F10
-------------------	----------------------------------

#### D.4.g. Example Data Test Patterns and Resulting Parity Values

The following examples are intended to provide a means to verify parity generation correctness for each of the six LDPC variants. These examples are provided for the purpose of LDPC encoder design verification; were generated using fixed test pattern data blocks; and provide the corresponding parity values for each of the standard rates. The examples include one fixed test pattern data block for a block size of 1024 bits as well as one for a block size of 4096 bits along with the resulting parity bit results for the three different rates.

##### D.4.g(1) Data Block (k = 1024 bits) Test Pattern Information

The example test pattern for this block size consists of 16-bit values that count up from zero with a trailing 32-bit frame sync occupying the last two words for a total of 64 16-bit values. This example data block was used to generate the resulting parity values for the three standard code rates.

Example 1024-bit test pattern values in hexadecimal are as follows.

```
0000000100020003000400050006000700080009000A000B000C000D000E000F001000110012
0013001400150016001700180019001A001B001C001D001E001F002000210022002300240025
0026002700280029002A002B002C002D002E002F003000310032003300340035003600370038
0039003A003B003C003DFE6B2840
```

The following are the resulting parity values using the above 1024-bit test pattern and applying the proper code rate encoding computation.

Parity (Code Rate = 1/2, Information Block Size = 1024, M = 512):

```
88C25789C85FFC52B331FFD279EB689EAF7007024078EDE8248057851F3E877693663BEA
FFE58810265686F4C51B698F366584549FA83C52FA23AC7AE1AF2D0D10268182D4E3B82
98990A514A6854A3D6FEFF59B69296BD601B16A7C1E827A2DC13045F1EA883A7F7ADF
621666D0865DCD14B094C280CC9E0948F460E5113622
```

Parity (Code Rate = 2/3, Information Block Size = 1024, M = 256):

```
D4E830063C6EA310B7DC85CC05E7E7721078503ED0061FCA7B796F1612C79A6B89171D
8AF5D773868EA94F2DD722F0F7952AE2034E6CCF0E1DD9FC5224B2AF3F
```

Parity (Code Rate = 4/5, Information Block Size = 1024, M = 128):

```
799EE0CE3994059D9FA69D26C6A0DF9BAF29C7B008F16B88A020056356BF8915
```

##### D.4.g(2) Data Block (k = 4096 bits) Test Pattern Information

The example test pattern for this block size consists of 16-bit values that count up from zero with a trailing 32-bit frame sync occupying the last two words for a total of 256 16-bit values. This example data block was used to generate the resulting parity values for the three standard code rates.

Example 4096-bit test pattern values in hexadecimal are as follows:

```
0000000100020003000400050006000700080009000A000B000C000D000E000F001000110012
0013001400150016001700180019001A001B001C001D001E001F002000210022002300240025
0026002700280029002A002B002C002D002E002F003000310032003300340035003600370038
0039003A003B003C003D003E003F0040004100420043004400450046004700480049004A004
B004C004D004E004F0050005100520053005400550056005700580059005A005B005C005D0
```

05E005F0060006100620063006400650066006700680069006A006B006C006D006E006F0070  
007100720073007400750076007700780079007A007B007C007D007E007F0080008100820083  
008400850086008700880089008A008B008C008D008E008F0090009100920093009400950096  
009700980099009A009B009C009D009E009F00A000A100A200A300A400A500A600A700A8  
00A900AA00AB00AC00AD00AE00AF00B000B100B200B300B400B500B600B700B800B90  
0BA00BB00BC00BD00BE00BF00C000C100C200C300C400C500C600C700C800C900CA00  
CB00CC00CD00CE00CF00D000D100D200D300D400D500D600D700D800D900DA00DB00  
DC00DD00DE00DF00E000E100E200E300E400E500E600E700E800E900EA00EB00EC00ED  
00EE00EF00F000F100F200F300F400F500F600F700F800F900FA00FB00FC00FDFE6B2840

The following are the resulting parity values using the above 4096-bit test pattern and applying the proper code rate encoding computation.

Parity (Code Rate = 1/2, Information Block Size = 4096, M = 2048):

AE1BA1553F901C1966B2115918D55011CF585B2397867854FBEA39176232555211A92640  
C1105814503C7F2096343AD836CCE6733793E2D45EBEC36E42993424690A1B95341E0B8  
ED20D1DAC0400817DBC8BDF995402928C67602BA3448805F80DA2D4632ED279F0C5C2  
A6BA4B9386FBC5E4121AD98B0C2FD18F4A977C3D9B9012D278E0F46F2822EDD0B57B  
B165C45407A53E42BB05FC4A97005E1E677DBEA8EBEE1CA4F9CCC7C31EDA7065A57  
A49BBA775914EAFBA330239F955DDEB32061DD6D40D995B6C47BF1B08C38023837617  
E53C82715EA4D11AE422E11CEAA97A35DBC62A475359826B7A9EABB6E8A3B7B4ABC  
BF32C2D9CC090D20F320CAA85759BCE91A5E32068A60B2EAEC0B321D6F22F31F91A  
6C73FD94EA4F26D91F88F353293177938276EEC3AF050BC3FB8F9258B88423BE8A0F8A  
EC609971D0B22752161A81FE5BC88F396C73430FF0B79B555440D17A1F0E9D5375B6D9  
AD6337AFFAF743E7E198D8B45BCC80E27D3441D57F9C362A0385F0C2774E038E1DBAC  
256BCD61AA2DB82681CABA315E759B1F24D6B729294B4C2DAB81A6CB701C564CAE8  
DDC3D281449DBCEDF2D1B6625781CC9CDAB32354F05548645AB2D720BC6CE69360D5  
1D876B987FFF35C020D9FB6255B452A215B77810B7283CC3EE98C288B2B8B3C2AFF023  
3AB9AA77E39466677AD8AB97363CE8F0BF4120333191CDF0E36E91ABF64

Parity (Code Rate = 2/3, Information Block Size = 4096, M = 1024):

5406F5FAD70A1D1012D88BFEBF612626CAE419504EED672004CFAA84FE66E1B8B74F4  
1B820AB5C9740171B8314FA8CED9E54812F5CB84C5ED3DDEAD5B8993CEA6852F144E  
DFE9F39BA1BDC299699965BEC1B5FAAA373668952AC4B53717A4285D40B6118672BA  
D9A6D2BCA70F00CD4E99CCB726B7D15D893407E54CE7083D9A6B9B1A6224B7D8FCD  
EBCB6EA0AD5F049870AA8BB22DC6DB74C2B71E7D37CF7164E3E057953646BEB15C4A  
06206D3A54668DD769457F25821DDB7C45F5720E2CCE95F06287844A0E24CA1B7170F67  
DD71AD528B85A6D28BE08F692F54FEA2D255913FB917264304B890F6348DAAFE421C3  
B312A69E30F5B99D4DC008DC2722620B

Parity (Code Rate = 4/5, Information Block Size = 4096, M = 512):

29B2733B0F079239C6DF5D72D10F3BC5AC7DEAF808B3FF7F1AC0ABF1991B77CC5086  
D31E93D4C900840EE689B9C4D1400E99C64C71C9BAA48FA5EA007B63964EB965EC624  
5F9084729C4C19BB42679924F88FFF268CF2BD1E23EDED11C2C444E2A29903778C846B4  
EFBE05B280AA42B661FE33B650F4F431E6EE7CAF9BB0AAF9

### D.5. Synchronization

Current receiver/demodulator designs can perform either coherent or non-coherent detection and demodulation. To accomplish symbol/bit synchronization, the transmitted synchronization sequence must contain sufficient transitions to ensure symbol/bit acquisition and tracking. At the same time, the symbol/bit synchronizer loop bandwidth should be designed for optimal phase-noise filtering and symbol tracking performance. Since the use of LDPC code does not guarantee sufficient bit/symbol transitions to acquire or maintain synchronization, it is highly recommended that a pseudo-randomizer be used after LDPC encoding in accordance with Section [D.6](#).

The ASM, depicted in [Figure D-8](#) and [Table D-10](#), is not randomized. Randomization ensures that coded symbols are spectrally near-white, thus allowing each ASM to provide synchronization for a set of randomized codeblocks in a codeblock frame.

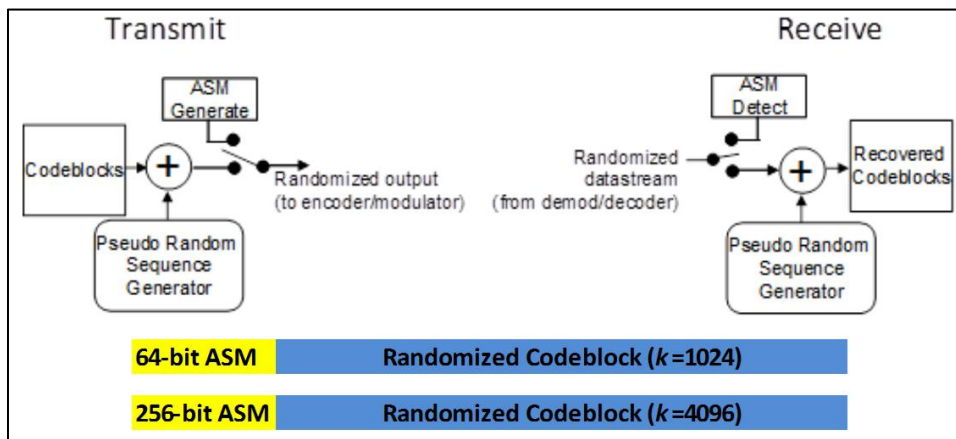

Figure D-8. ASM/Codeblock Structure

Table D-10. ASM Definition	
64-bit Sequence	Definition (hex)
$A$	FCB88938D8D76A4F
$\bar{A}$	034776C7272895B0

At the transmitter side, the ASM is prepended to each set of randomized codeblocks as the synchronization header. At the receiver side, the ASM is detected and located in the received data stream. Refer to [Figure D-8](#).

Length of the ASM is determined by the information block length ( $k$ ). For  $k=1024$  the ASM length will be 64 bits. For  $k=4096$  the ASM will be 256 bits. The ASM is constructed with 64-bit sequences. The 64-bit ASM requires one 64-bit sequence; the 256-bit ASM sequence requires four 64-bit sequences. Let  $A$  be one 64-bit sequence and  $\bar{A}$  is the inverse of  $A$ . The structure of the 64-bit sequence is  $A$ ; the structure of the 256-bit ASM is  $AA\bar{A}\bar{A}$ . [Table D-10](#) defines the two 64-bit sequences.

The resulting randomized codeblock plus ASM is transmitted leftmost bits first, making the first series of bits to be transmitted as FCB8..... or 111110010111000..... This is true for both 64-bit and 256-bit ASMs.

With the addition of the ASM prepended to the codeblock, over-the-air channel rate is no longer the inverse of the code rate  $r$ . [Table D-11](#) shows the exact bandwidth expansion factor for each choice of code rate and information block length.

<b>Table D-11. Bandwidth Expansion Factor</b>			
Information Block Length, $k$	Bandwidth Expansion Factor		
	Rate 1/2	Rate 2/3	Rate 4/5
1024	33/16	25/16	21/16
4096	33/16	25/16	21/16

As an example, assume an incoming baseband data rate of 5 Mbps. If an information block length of 1024 bits and rate 1/2 are chosen, the new over-the-air channel rate will be:

$$(5 \text{ Mbps}) * (33/16) = 10.3125 \text{ Mbps}$$

### D.6. Randomization

At the transmitter/encoder, a set of codeblocks in a codeblock frame shall be randomized by exclusive-ORing the first bit of the first codeblock with the first bit of the pseudo-random sequence until the end of the codeblock. The pseudo-randomizer resets to the initial state of all 1s at the start of each codeblock frame for each ASM period.

The pseudo-random sequence is generated using the following polynomial:  $h(x) = x^8 + x^7 + x^5 + x^3 + 1$ . It has a maximal length of 255 bits with the first 40 bits of the pseudo-random sequence from the generator as 1111 1111 0100 1000 0000 1110 1100 0000 1001 1010..... The sequence begins at the first bit of a first codeblock in a codeblock frame and repeats after 255 bits, continuing repeatedly until the end of the last codeblock in a codeblock frame. The leftmost bit of the pseudo-random sequence is the first bit to be exclusive-ORed with the first bit of the codeblock. [Figure D-9](#) illustrates the pseudo-randomizer block diagram.

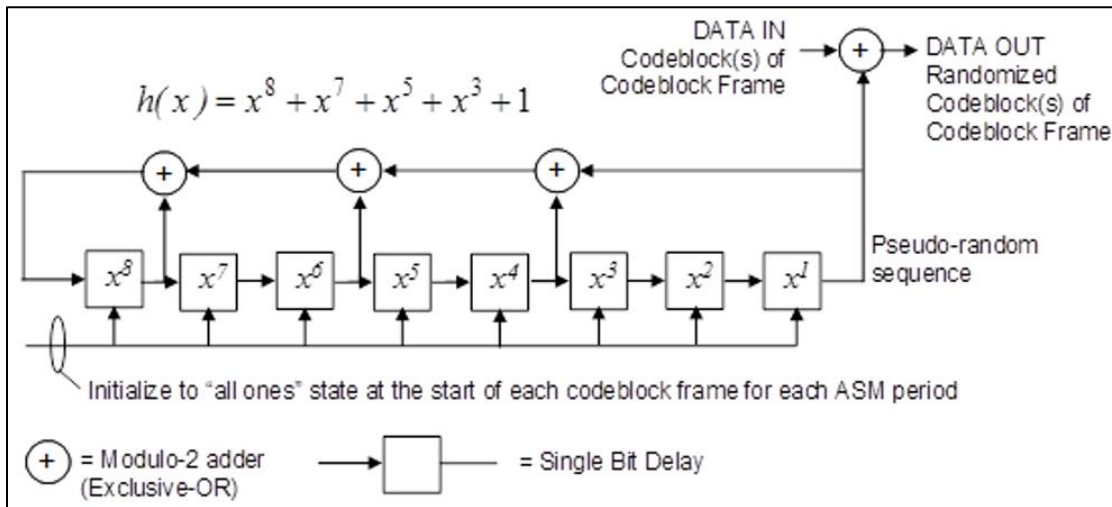

Figure D-9. Codeblock Randomizer

At the receiver, each original codeblock of a codeblock frame is reconstructed using the same pseudo-random sequence. After locating the ASM, the pseudo-random sequence is

exclusive-ORed with the received data bits immediately following the ASM. The pseudo-randomizer resets to the initial state of all 1s at the start of each received codeblock frame for each ASM period.

### D.7. Performance

The trade that must be made when choosing the information block size and coding rate is one between required coding gain, bandwidth expansion, and fading channel characteristics. Detection performance of the code is tightly coupled to the type of SOQPSK-TG demodulator used. Plots of simulated performance for all six combinations of information block size and code rates with two different types of SOQPSK-TG demodulators on are shown in [Figure D-10](#) and [Figure D-11](#). Other demodulator configurations are considered in Perrins.<sup>48</sup>

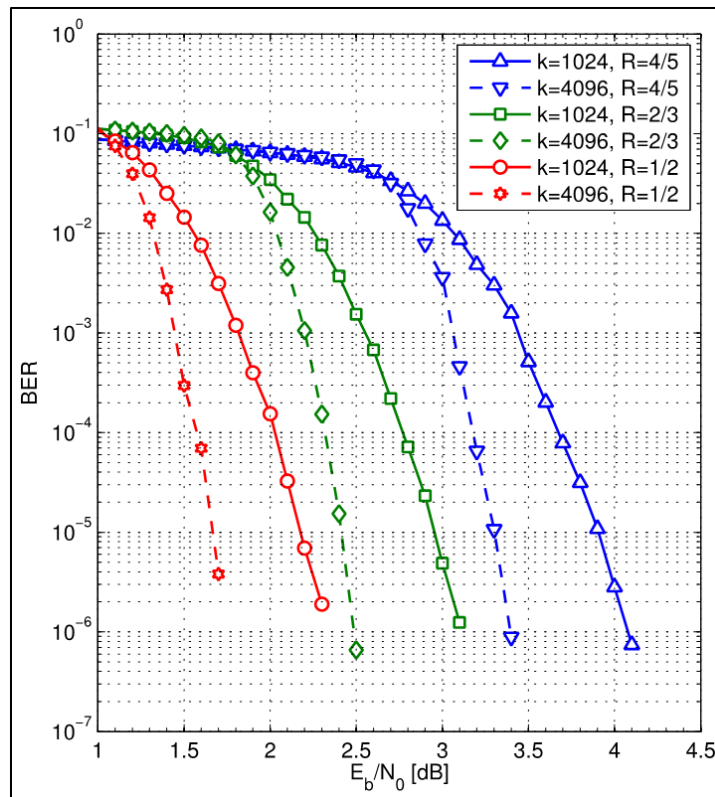

Figure D-10. LDPC Detection Performance with 4-state Trellis Demodulator

<sup>48</sup> Perrins, "FEC Systems for Aeronautical Telemetry."

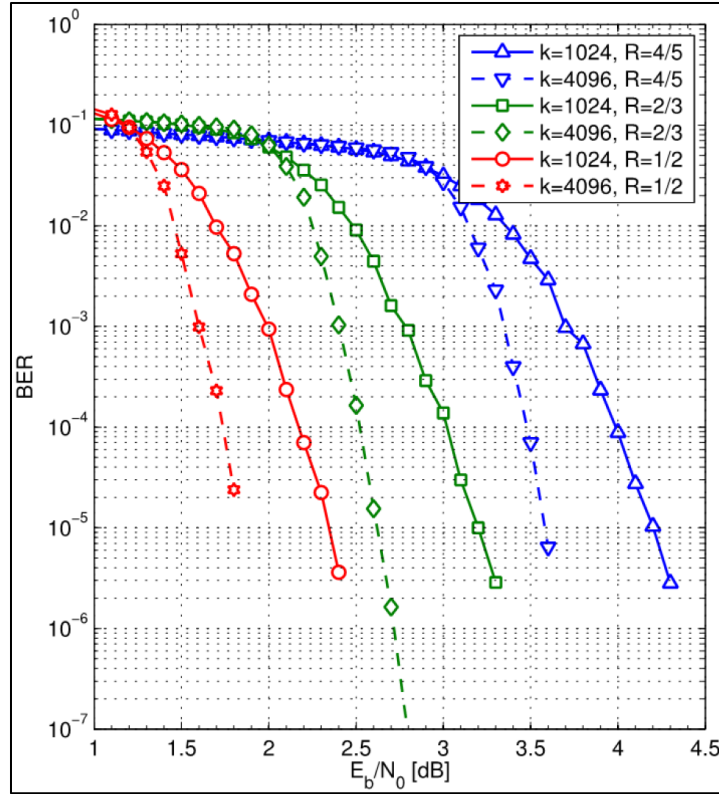

Figure D-11. LDPC Detection Performance with Symbol-by-Symbol Demodulator

## APPENDIX 2-E

### Space-Time Coding for Telemetry Systems

#### E.1. Code Description

The STC used in this standard is based on the Alamouti STC<sup>49</sup> and applied only to SOQPSK-TG or any of its fully interoperable variants. The Alamouti STC may be described in terms of the OQPSK IRIG-106 symbol-to-phase mapping convention illustrated in [Figure E-1](#).

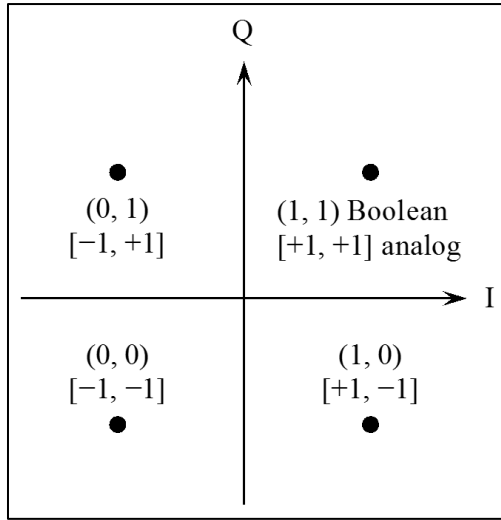

Figure E-1. Symbol-to-Phase Mapping for IRIG-106 Offset QPSK Modulation

The starting point is the normalized analog values corresponding to each of the OQPSK symbols. Let  $[a_n, b_n]$  with  $a_n = \pm 1, b_n = \pm 1$  be the analog value of the  $n$ -th symbol. Suppose the bit sequence defines the sequence of symbols

$$[a_0, b_0], [a_1, b_1], [a_2, b_2], [a_3, b_3], \dots, [a_{2k}, b_{2k}], [a_{2k+1}, b_{2k+1}], \dots$$

The Alamouti STC organizes the symbols into blocks of two symbols, starting with the even-indexed blocks as shown. The Alamouti STC assigns the  $k$ -th block of symbols

$$[a_{2k}, b_{2k}], [a_{2k+1}, b_{2k+1}]$$

to antenna 0 and antenna 1 over two consecutive symbol times as shown below.

antenna	symbol time $2k$	symbol time $2k+1$
0	$[a_{2k}, b_{2k}]$	$[-a_{2k+1}, b_{2k+1}]$
1	$[a_{2k+1}, b_{2k+1}]$	$[a_{2k}, -b_{2k}]$

<sup>49</sup> S. Alamouti. "A Simple Transmit Diversity Technique for Wireless Communications." *IEEE Journal on Selected Areas in Communications*, vol. 16, no. 8, pp. 1451-1458, October 1998.

Using the bit (Boolean) assignments shown in [Figure E-1](#), the Alamouti encoder can be restated in terms of the input bits as follows. Let the sequence of input bits be

$$b_0 \ b_1 \ b_2 \ b_3 \ | \ b_4 \ b_5 \ b_6 \ b_7 \ | \ \dots \ | \ b_{4k} \ b_{4k+1} \ b_{4k+2} \ b_{4k+3} \ | \ \dots$$

The STC encoder groups the bits into non-overlapping blocks of four bits each as indicated by the vertical lines. The STC encoder produces two bit streams in parallel:  $\mathbf{b}_0$ , which is applied to antenna 0, and  $\mathbf{b}_1$ , which is applied to antenna 1. The relationship between the input bit sequence and these two bit sequences is

$$\begin{aligned} \mathbf{b}_0 &= b_0 b_1 \bar{b}_2 b_3 \ | \ b_4 b_5 \bar{b}_6 b_7 \ | \ \dots \ | \ b_{4k} b_{4k+1} \bar{b}_{4k+2} b_{4k+3} \ | \ \dots \\ \mathbf{b}_1 &= b_2 b_3 b_0 \bar{b}_1 \ | \ b_6 b_7 b_4 \bar{b}_5 \ | \ \dots \ | \ b_{4k+2} b_{4k+3} b_{4k} \bar{b}_{4k+1} \ | \ \dots \end{aligned}$$

where  $\bar{b}_n$  is the logical complement of bit  $b_n$ .

An important point here is the notion of even- and odd-indexed bits. The SOQPSK-TG modulator treats even-indexed and odd-indexed bits slightly differently. Each codeblock must begin with an even-indexed bit.

An example of encoding is as follows. Suppose the input bit sequence is

1 0 1 1 0 1 0 0

The two STC encoded bit sequences are

$$\begin{aligned} \mathbf{b}_0 &= 1 \ 0 \ 0 \ 1 \ 0 \ 1 \ 1 \ 0 \\ \mathbf{b}_1 &= 1 \ 1 \ 1 \ 1 \ 0 \ 0 \ 0 \ 0 \end{aligned}$$

To make provision for the estimation of frequency offset, differential timing, and the channels, a block of known bits, called pilot bits, is periodically inserted into each of the two bit streams. A 128-bit pilot block is inserted every 3200 Alamouti-encoded bits. The pilot bits inserted into the  $\mathbf{b}_0$  bit stream are denoted  $\mathbf{p}_0$  and the pilot bits inserted into the  $\mathbf{b}_1$  bit stream are denoted  $\mathbf{p}_1$ . These pilot bit sequences are

$$\begin{aligned} \mathbf{p}_0 &= 10101000100011011001101011010100 \\ &\quad 1101110001000000100100101000111 \\ &\quad 11100010100100100000001000111011 \\ &\quad 00101011010110011011000100010101 \\ \\ \mathbf{p}_1 &= 11100011110001110111011101100001 \\ &\quad 11110000011100000011011010111110 \\ &\quad 01111101011011000000111000001111 \\ &\quad 10000110111011101110001111000111 \end{aligned}$$

A notional diagram illustrating how  $\mathbf{p}_0$  and  $\mathbf{p}_1$  are periodically inserted into  $\mathbf{b}_0$  and  $\mathbf{b}_1$ , respectively, is illustrated in [Figure E-2](#). Note that the bits comprising  $\mathbf{b}_0$  and  $\mathbf{b}_1$  may change with every occurrence as defined by the input data, but the pilot bits  $\mathbf{p}_0$  and  $\mathbf{p}_1$  do not change with each occurrence.



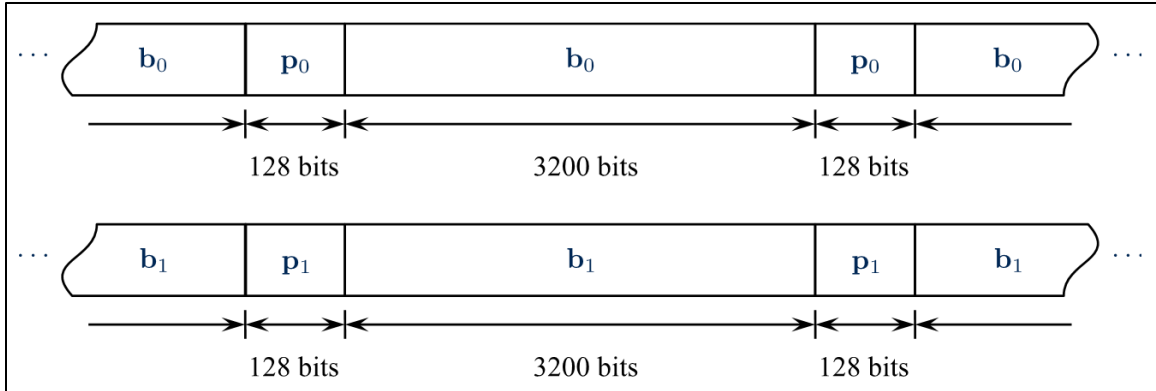

Figure E-2. Notional Diagram Illustrating the Periodic Insertion of 128 Pilot Bits Every 3200 Alamouti-Encoded Bits

## E.2. Modulation

The bit sequences described in the previous section are modulated by a pair of SOQPSK-TG modulators (or modulator/transmitters). The modulators should be constructed and used as follows.

- The modulators share a common clock. This common clock is  $26/25$  times the input clock to accommodate the periodic insertion of 128 pilot bits every 3200 Alamouti-encoded bits.
- The modulators should share a common carrier reference. If this is not possible, the two carrier references should be phase-locked ideally, or frequency-locked at a minimum.
- Randomization, if required, should be applied before the STC encoder.
- Differential encoding should be disabled. The periodically inserted pilot bits are to be used by the demodulator to estimate the magnitudes and phases of the antenna 0-to-receiver channel and the antenna 1-to-receiver channel. There is no need to use differential encoding because data-aided phase estimates do not possess a phase ambiguity.<sup>50</sup>

[Figure E-3](#) is a notional block diagram that shows the relationship between the input data and clock, the bit-level space-time encoder, the periodic pilot bit insertion, and the SOQPSK-TG modulation.

<sup>50</sup> M. Rice. *Digital Communications: A Discrete-Time Approach*. Pearson/Prentice-Hall. Upper Saddle River, NJ, 2009.

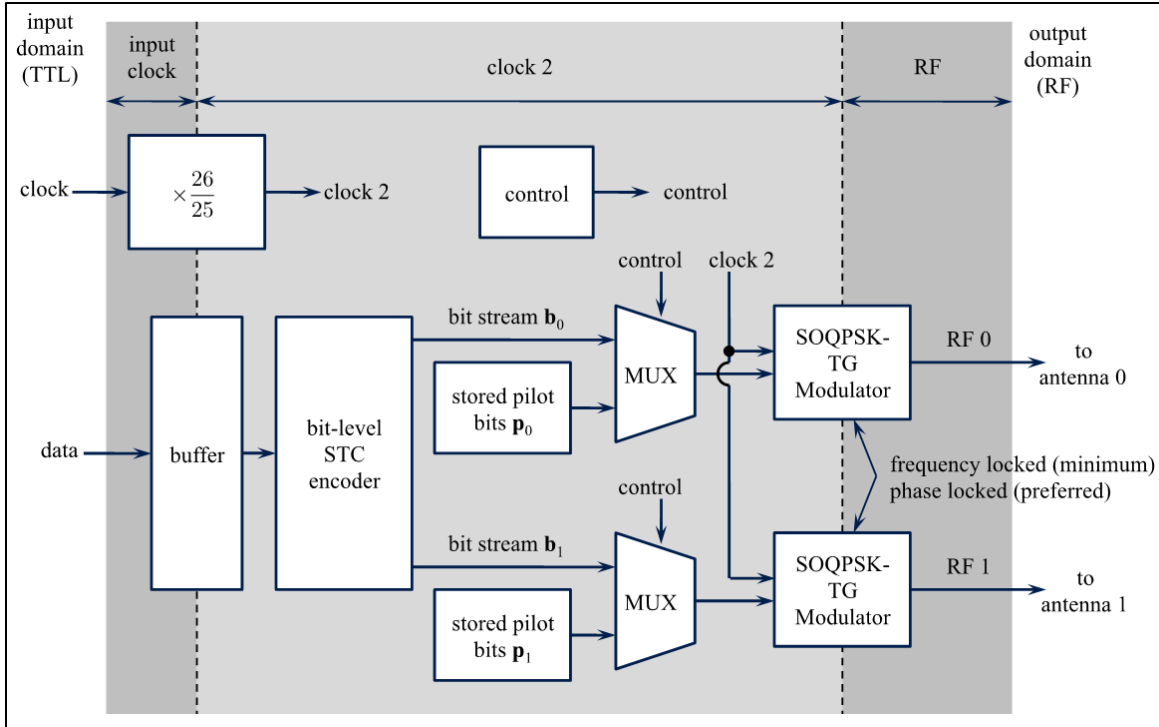

Figure E-3. Notional Block Diagram of the Space-Time Code Transmitter

### E.3. Performance

The STC process involves the transmission of two separate, but related, orthogonal signals to compensate for the self-interference that accompanies dual-antenna transmission of the same signal. The transmitted signals must each travel through a transmission channel that will affect each signal prior to being presented to the telemetry receiver. If  $S_0(t)$  represents the transmitted signal corresponding to  $\mathbf{b}_0$  and  $S_1(t)$  represents the transmitted signal corresponding to  $\mathbf{b}_1$ , then the received signal, assuming no frequency offset, may be expressed as

$$r(t) = h_0 S_0(t - \tau_0) + h_1 S_1(t - \tau_1) + n(t)$$

Where:

$h_0$  is the attenuation of the path between transmitter output  $S_0(t)$  and the receive antenna

$h_1$  is the attenuation of the path between transmitter output  $S_1(t)$  and the receive antenna

$\tau_0$  is the delay between the transmitter output  $S_0(t)$  and the receive antenna

$\tau_1$  is the delay between the transmitter output  $S_1(t)$  and the receive antenna

$n(t)$  is the thermal noise of the receiver

Each of the channel attenuations are complex valued:  $h_0 = |h_0|e^{j\theta_0}$  where  $|h_0|$  represents the magnitude of the attenuation and  $\theta_0$  represents the phase shift associated with the attenuation. Similarly,  $h_1 = |h_1|e^{j\theta_1}$ . The channel attenuations model the connector and cabling losses between the transmitter output and the transmit antenna, the antenna radiation pattern in the direction of the receive antenna, blockage by the test article (shadowing), atmospheric propagation, and the gain of the receive antenna. In general,  $h_0$  and  $h_1$  are different because the

antennas transmitting  $S_0(t)$  and  $S_1(t)$  are in different locations. For the same reasons,  $\tau_0$  and  $\tau_1$ ,  $\theta_0$  and  $\theta_1$  are, in general, different. [Figure E-4](#) plots the detection curves for several examples of  $|h_0|/|h_1|$ ,  $\tau_0 - \tau_1$ , and  $\theta_0 - \theta_1$ .

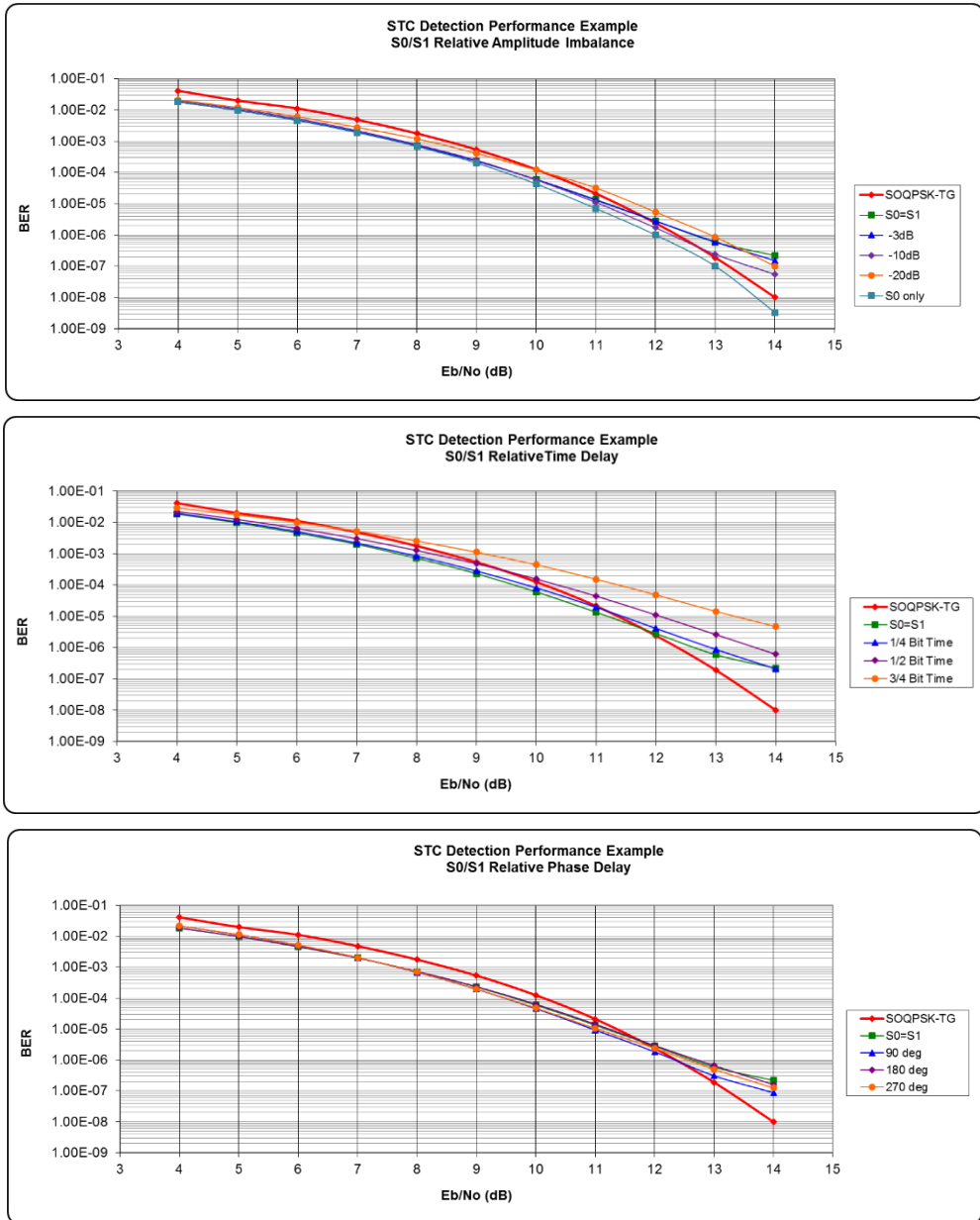

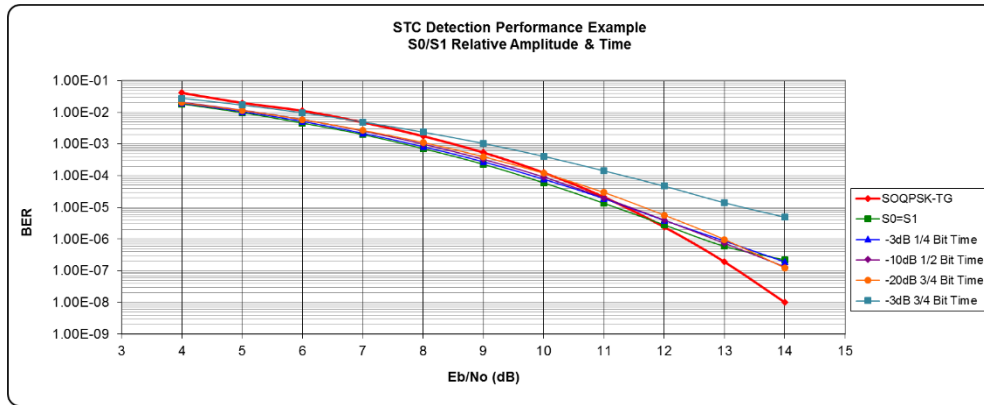

Figure E-4. Example Detection Curve Performance

#### E.4. Resources

Jensen, et al.<sup>51</sup> first described the application of space-time coding to the two-antenna problem. Experimental flights confirmed the effectiveness of the technique.<sup>52,53,54</sup> A detailed mathematical description along with a thorough mathematical analysis were also accomplished for this technique.<sup>55,56</sup>

#### E.5. Combining Coding Schemes

The STC and LDPC schemes can be combined if the manufacturer's equipment supports both and the two are applied in the proper order. The transmitter should apply LDPC encoding first, followed by STC encoding. At the receiver, STC decoding is performed first, followed by LDPC decoding.

Note that some manufacturers may limit the LDPC coding rate and/or block size that can be used with STC. Detection performance of this STC-LDPC combination is on par with the curves published in [Appendix 2-D](#).

<sup>51</sup> Jensen, M., M. Rice, and A. Anderson. "Aeronautical Telemetry Using Multiple-Antenna Transmitters." *IEEE Transactions on Aerospace and Electronic Systems*, vol. 43, no. 1, pp. 262-272, January 2007.

<sup>52</sup> M. Rice, "Space-Time Coding for Aeronautical Telemetry: Part 1 – System Description," in *Proceedings of the International Telemetry Conference*, Las Vegas, NV, October 2011.

<sup>53</sup> Rice, M. and K. Temple, "Space-Time Coding for Aeronautical Telemetry: part II – Experimental Results," in *Proceedings of the International Telemetry Conference*, Las Vegas, NV, October 2011.

<sup>54</sup> K. Temple. "Performance Evaluation of Space-Time coding on an Airborne Test Platform." Paper presented at the 50<sup>th</sup> International Telemetry Conference, San Diego, CA, October 2014.

<sup>55</sup> Rice, M., J. Palmer, C. Lavin, and T. Nelson. "Space-Time Coding for Aeronautical Telemetry: Part I – Estimators." *IEEE Transactions on Aerospace and Electronic Systems*, vol. 53, no. 4, pp. 1709-1731, August 2017.

<sup>56</sup> Rice, M., T. Nelson, J. Palmer, C. Lavin, and K. Temple. "Space-Time Coding for Aeronautical Telemetry: Part II – Decoder and System Performance." *IEEE Transactions on Aerospace and Electronic Systems*, vol. 53, no. 4, pp. 1732-1754, August 2017.

## APPENDIX 2-F

### Use of Recommendation ITU-R M.1459 for Protection of AMT Ground Stations from Terrestrial, Airborne, and Satellite Interference

#### F.1. Introduction and Summary

Since it was approved for use by the Radiocommunication Sector of the ITU in 2000, Rec M.1459 has been the international and US standard for defining the interference protection criteria and the use of those criteria for AMT ground stations.

Despite its title, Rec M.1459 pertains to interference not only from satellites, but also from terrestrial sources and has been so applied both domestically and internationally. The methodology presented in Annex A of Rec M.1459 for computing band-specific protection levels also makes it applicable to any frequency band. The protection criteria for lower L and upper S bands given in Rec M.1459 have thus been extended to include protection criteria for upper L, lower S, and lower, middle, and upper C bands. The protection criteria are included in [Chapter 2](#).

The protection criteria provided by Rec M.1459 are in the form of PFD levels defined at the aperture of the affected AMT ground station antenna. Thus, when performing interference analysis, it is not necessary to require information about the specific technical parameters of the affected AMT ground station, such as the actual AMT receive antenna gain, pointing direction, noise figure, or system gain over noise temperature. The only details needed are:

- the geographic location of the AMT ground station antenna;
- the height above ground of the AMT ground station antenna;
- the mid-band value of the wavelength for the frequency band under consideration;
- an accurate terrain data base in/around the AMT receive site (1 arc-second, or 30 meter resolution) for use with propagation models when computing interference from terrestrial sources;
- a composite antenna pattern based on the methodology of Rec M.1459, but adjusted for the average wavelength of the band under consideration, to be used when aggregation from a large number of terrestrial sources is being analyzed.

Section [F.2](#) contains several sample computations that illustrate how this information is used in practice. The examples begin with simple cases involving a small number of satellite and terrestrial interference sources. The scenarios presented increase in size and complexity to include networks comprised of thousands of interference sources (e.g., cellular towers). A variety of models, equations, and computational techniques is demonstrated, underscoring the versatility and comprehensive applicability of the Rec M.1459 protection criteria. A final example provides guidance on how to handle special cases, such as when antennas larger than those anticipated in Rec M.1459, are used.

#### F.2. Practical Application of the Rec M.1459 Protection Criteria

The examples in this section include, but are not limited to, interference from satellites, terrestrial microwave towers, cellular base stations, portable medical telemetry devices, and smartphones. Both adjacent channel and co-channel interference scenarios are included. Each

example is intended to provide and illustrate one or more building blocks that will sometimes, and perhaps often, be used in end-to-end interference analysis.

The discussions and computations here are based on a combination of publicly available data, standard assumptions regarding typical values of common parameters, and emission limits stipulated in FCC regulations. In some of the scenarios, FCC regulations are used as a source of band-specific emission masks that define the worst-case limits, as a function of frequency, that are permitted for OOBE from a particular frequency band or set of bands. Thus, the examples that follow are just that: examples. They are intended to demonstrate computational techniques and analysis. Unless otherwise stated, they should not be interpreted as either assertions or policy statements regarding whether interference does or does not exist in a particular scenario.

Examples 1 - 11 address:

1. Co-channel interference from a planned BSS satellite in geostationary orbit into AMT ground stations operating in the lower L-band between 1435 – 1525 MHz;
2. Co-channel interference from multiple spot-beam communication satellites in geostationary orbit into AMT ground stations operating in a portion of the lower L-band from 1518 – 1525 MHz;
3. Out-of-band interference from a SiriusXM broadcast satellite into an AMT ground station in the upper S-band from 2360 – 2390 MHz;
4. Frequency scaling of interference and interference criteria to different reference bandwidths;
5. Computation of path loss using the two-ray model;
6. Rayleigh fading of the aircraft telemetry signal;
7. Computation of path loss using commercial software that implements the Longley-Rice (L-R)/Irregular Terrain Model (ITM) and P.452 models;
8. Consideration of the antenna patterns of cellular base stations;
9. Aggregation of interference from a network of cellular base stations to one or more AMT ground stations;
10. Considerations for the modeling of interfering systems;
11. Coordination of AMT with 4G Long-Term Evolution (LTE)-A user equipment;
12. Special considerations regarding AMT antennas.

Each of these scenarios was chosen to illustrate a particular point or technique that is independent of Rec M.1459, but which is needed in order for the protection criteria of Rec M.1459 to be properly applied.

At the outset, it should be noted that the curvature of the earth complicates the trigonometry for computing elevation, azimuth, and bearing angles. For example, the elevation angle computed for the path from an AMT ground station to a flight test aircraft 320 km away operating at an altitude of 30,000 feet will be close to zero degrees due to the curvature of the earth.

Using a flat-earth approximation, the angle would be computed to be approximately 4 degrees, thus suggesting incorrectly that interference from terrestrial sources would not be received in the main beam of the AMT ground station.

The equations used in the representative examples below assume a spherical earth, as evidenced by the inclusion of the value for the radius of the earth in km (e.g., 6358 km). The flat-earth approximation is obtained by letting the value of the earth's radius go to infinity.

Use of the correct formulas is particularly important when computing the bearing angle from a cellular tower to an AMT ground station and when coding the table look-up algorithms for choosing appropriate cellular tower sector antenna gain values as functions of pointing angles from the appropriate antenna pattern files.

**Example 1.** Co-channel interference from a planned BSS satellite in geostationary orbit into AMT ground stations operating in the lower L-band between 1435 – 1525 MHz

Use of Rec M.1459 begins with a simple equation,

$$pfd_{rec} = P_{xmt}G_{xmt} \times (Path\_Loss) \times \frac{4\pi}{\lambda^2} \quad \text{F-1}$$

where  $PFd$  is the received PFD in watts per square meter. The quantity  $P_{xmt}G_{xmt}$  is the product of the transmit power of the interfering source and the gain of the transmit antenna. Path loss depends on distance, signal blockage due to terrain blockage and/or clutter (e.g., buildings), and wavelength  $\lambda$ . For free-space propagation, however, path loss is given by:

$$path\ loss = \frac{\lambda^2}{(4\pi)^2 r^2} \quad \text{F-2}$$

Free-space propagation is appropriate for modeling signals from satellites, such as from a geostationary satellite to an AMT ground station antenna. This yields the simple result that:

$$pfd_{rec} = \frac{P_{xmt}G_{xmt}}{4\pi r^2} \quad \text{F-3}$$

For the sake of completeness, the received power, as measured at the terminals of the receive antenna, requires inclusion of the effective area of the receive antenna. This will be discussed in detail in example 7. It is sufficient to quote the result here:

$$P_{rec} = pfd_{rec} \times A_{eff} = \frac{P_{xmt}G_{xmt}\lambda^2 G_{rec}}{(4\pi)^2 r^2} \quad \text{F-4}$$

This is the Friis equation, where  $A_{eff}$  is the effective area of the receive antenna. For a parabolic dish,  $A_{eff}$  is often approximated by  $0.5 \times \pi(D/2)^2$ , where  $D$  is the diameter of the dish. The value for the wavelength of the signal  $\lambda$  is typically the mid-band value where  $\lambda=c/f$ .

The distance  $r$  and elevation angle  $\alpha$  from an AMT ground station antenna to a geostationary satellite are determined using either standard textbook equations (included in Example 2), web-based calculators, or from FCC filings, which can be particularly useful because they also include information about the channel bandwidths, signal power, and transmit antenna gain.

The elevation angle  $\alpha$ , which does not appear in equations [F-1](#) – [F-3](#), is needed in order to determine the appropriate protection criterion from Rec M.1459. For example, the lower L-band protection criteria from [Table 2-7](#) present these criteria as functions of  $\alpha$ .

To apply this to a particular case, a comparison of the PFD contours at ground level of a BSS satellite is compared with the angle-of-arrival dependent protection criteria of Rec M.1459. The contours were made available by the developers of the satellite. The comparison shows conclusively that the planned deployment of the satellite would cause harmful interference to AMT ground stations in the United States (e.g.,  $-150$  decibels relative to one watt [dBW]/m<sup>2</sup> in 4 kHz, versus the allowed limit of  $-180$  dBW/m<sup>2</sup> in 4 kHz). As a consequence of this analysis, the satellite was not deployed.

Specifically, the co-channel emissions were so large with respect to the Rec M.1459 protection criteria that it wasn't necessary to perform a detailed, angle-of-arrival-dependent computation of the interference from the satellite.

**Example 2.** Co-channel interference from multiple spot-beam communication satellites in geostationary orbit into AMT ground stations operating in a portion of the lower L-band from 1518 – 1525 MHz

The 2003 World Radiocommunication Conference coincided with the launch of a new generation of Mobile Satellite Service geostationary communication satellites. These satellites, including Inmarsat IV and Thuraya, introduced the use of complex phased-array beam-forming networks with large parabolic reflectors. The resulting spot beams permit the following: the use of portable handsets with omnidirectional antennas for making telephone calls via satellite; and the simultaneous generation of dozens, and even hundreds, of simultaneous beams. Each beam serves a separate user.

In seeking additional spectrum to support the use of these satellites, the mobile satellite community proposed the allocation of the AMT spectrum from 1518 – 1525 MHz for co-channel sharing with the Mobile Satellite Service. As with the BSS satellite in example 1, application of Rec M.1459 demonstrated that co-channel sharing was not feasible.

In recognition of this, WRC-2003 modified Table 21-4 of Article 21 of the International Radio Regulations<sup>57</sup> to include the following PFD fence that protects AMT operations in the continental United States. In other words, the Conference incorporated the protection criteria of Rec M.1459 in the international radio regulations. [Figure F-1](#) is an excerpt of Article 21.16 of these regulations.

---

<sup>57</sup> International Telecommunications Union. "Radio Regulations: Articles." 2012. May be superseded by update. Retrieved 17 May 2021. Available at <http://search.itu.int/history/HistoryDigitalCollectionDocLibrary/1.41.48.en.101.pdf>.



**21.16** § 6 1) The power flux-density at the Earth’s surface produced by emissions from a space station, including emissions from a reflecting satellite, for all conditions and for all methods of modulation, shall not exceed the limit given in Table 21-4. The limit relates to the power flux-density which would be obtained under assumed free-space propagation conditions and applies to emissions by a space station of the service indicated where the frequency bands are shared with equal rights with the fixed or mobile service, unless otherwise stated.

TABLE 21-4 (Rev.WRC-12)

Frequency band	Service*	Limit in dB(W/m <sup>2</sup> ) for angles of arrival ( $\delta$ ) above the horizontal plane			Reference bandwidth	
		0°-5°	5°-25°	25°-90°		
1 670-1 700 MHz	Earth exploration-satellite Meteorological-satellite	-133 (value based on sharing with meteorological aids service)			1.5 MHz	
1 518-1 525 MHz (Applicable to the territory of the United States in Region 2 between the longitudes 71° W and 125° W)	Mobile-satellite (space-to-Earth)	0° ≤ $\delta$ ≤ 4°	4° < $\delta$ ≤ 20°	20° < $\delta$ ≤ 60°	60° < $\delta$ ≤ 90°	4 kHz
		-181.0	-193.0 + 20 log $\delta$	-213.3 + 35.6 log $\delta$	-150.0	

Figure F-1. Excerpt from Article 21 of the International Radio Regulations

**Example 3.** Out-of-band interference from a SiriusXM broadcast satellite into an AMT ground station in the upper S-band from 2360 – 2390 MHz

This next example provides a computation of OOBE into an AMT ground station from an operational geostationary satellite. This example serves to show an end-to-end computation of the out-of-band signal received at an AMT ground station antenna at Patuxent River (Pax River), Maryland from the SiriusXM satellite denoted as FM-6. This is a Satellite Digital Audio Radio Service (SDARS) broadcast satellite in geostationary orbit above the equator at 115.2 degrees west longitude.<sup>58</sup> FM-6 broadcasts in a 4.1-MHz portion of the 2320.0 – 2332.5 MHz band.

Note that the SDARS band (2320-2345 MHz) is separated from the 2360 – 2390 MHz AMT band by the 2345 – 2360 MHz WCS band (which is the topic of example 6, below).

Given that the SDARS channel is more than 15 MHz away from the edge of the AMT band at 2360 MHz, co-channel sharing is not relevant; however, the OOBE of the FM-6 satellite remain a concern, due to the high gain (30 – 40 decibels isotropic [dBi] and more) of a typical AMT ground station antenna.

The FCC restricts the OOBE of FM-6, relative to its mean transmitter power level  $P_{xmt}$  (and not including the effects of the satellite’s antenna gain  $G_{xmt}$ ) in the FCC Rules, part §25.202(f) (1), (2), and (3).<sup>59</sup> These are available online, but are restated here:

<sup>58</sup> The satellite is actually in operation at 116.1° W, but the computations here are performed for its originally intended geostationary orbital slot.

<sup>59</sup> Code of Federal Regulations, Frequencies, frequency tolerance, and emission limits, title 47, sec. 25.202.

The mean power of emissions shall be attenuated below the mean output power of the transmitter in accordance with the following schedule:

- (1) In any 4 kHz band, the center frequency of which is removed from the assigned frequency by more than 50 percent up to and including 100 percent of the authorized bandwidth: 25 dB;
- (2) In any 4 kHz band, the center frequency of which is removed from the assigned frequency by more than 100 percent up to and including 250 percent of the authorized bandwidth: 35 dB;
- (3) In any 4 kHz band, the center frequency of which is removed from the assigned frequency by more than 250 percent of the authorized bandwidth: An amount equal to 43 dB plus 10 times the logarithm (to the base 10) of the transmitter power in watts.

Since the authorized bandwidth of FM-6 is 4.1 MHz and the AMT band is removed from this frequency by more than 250%, the  $43 + 10 \log(P)$  rule applies, where  $P$  is the out-of-band transmitter PSD in watts per 4 kHz of bandwidth. Specifically, the value  $43 + 10 \log(P)$  is the amount the OOB must be attenuated with respect to the transmitter power  $P$  per 4 kHz of bandwidth. With the rule written in this manner, if the transmitter power  $P$  is increased, the amount by which the OOB must be attenuated increases by the same amount.

(This is a well-recognized OOB standard, but it is essential to note that the reference bandwidth for the example here is stipulated to be 4 kHz, whereas a reference value of 1 MHz may be more common in FCC rules).

The purpose of the  $\log(P)$  term is to set a hard OOB power limit that is independent of the mean in-band transmitter power  $P$ . For the purpose of computing interference into AMT operations in 2360 – 2390 MHz using equations [F-1](#) – [F-3](#), the interference from FM-6 can be characterized simply by setting the transmitter power  $P$  to 0 dBW. Then, the magnitude of the interfering level  $P_{xmt}$  is  $-43$  dBW, which is equal to  $-13$  dBm, or  $50 \mu\text{W}$  per 4 kHz. This corresponds to an attenuation of the in-band power by 43 dB. Note that if the in-band power is set to 10 dBW, the  $43 + 10 \log(P)$  rule requires 53 dB of out-of-band attenuation, and the value of  $P_{xmt}$  is unchanged.

With respect to equations [F-1](#) – [F-3](#), to compute the interference from FM-6 into any AMT ground station, it is also necessary to know the following.

- The satellite's transmit antenna gain  $G_{xmt}$  in the direction of the affected AMT site (in order to convert the  $43 + 10 \log(P)$  value into a radiated power level). This satellite-specific information is usually derived from information provided by the satellite operator or from FCC and/or ITU technical filings. For this example, the information is obtained from an FCC filing, as shown later in this section.
- The angle of arrival of the signal at the AMT site (in order to determine the appropriate value of the protection criteria). This can be obtained from a graph in the same FCC filing or can be computed from equations [F-5a](#) and [F-5b](#).
- The distance from the satellite to the ground station (in order to compute the free space path loss). This is computed from Equation [F-6](#).

Note that these equations, as written, apply only to geostationary satellites.<sup>60</sup>

$$\alpha_s = \arcsin[\cos(\theta_e)\cos(\phi_{se})] \quad \text{F-5a}$$

$$\alpha = \arctan \left\{ \frac{\sin(\alpha_s) - R_{earth}/R_{satellite}}{\cos(\alpha_s)} \right\} \quad \text{F-5b} \quad \text{F-5}$$

$$r = \sqrt{R_{satellite}^2 - R_{earth}^2 \cos^2(\alpha)} - R_{earth} \sin(\alpha) \quad \text{F-5c}$$

where  $\alpha$  is the elevation angle to the satellite (which is the same as the angle of arrival  $\alpha$  of the interference from the satellite),  $\theta_e$  is the latitude of the AMT ground station,  $\phi_{se}$  is the difference in the longitude values of the earth station and the satellite, and  $r$  is the distance from the AMT ground station to the satellite. Note that for geostationary satellites, the orbital radius  $R_{satellite}$  is the radius of the earth, 6358 km, added to the height of the satellite above the surface of the earth, 36,000 km. For an angle of arrival of  $\alpha = 90^\circ$ , Equation F-5 yields the value of  $r = (R_{satellite} - R_{earth})$ .

The geometry described by these equations is shown in [Figure F-2](#), excerpted from the text by Richharia.<sup>61</sup> The angle  $\eta$  in the figure corresponds to the angle  $\alpha$  in equations F-5 and F-6. The elevation cut is a two-dimensional surface for which the trigonometry of the earth's curvature can be solved by inspection. For the sake of completeness, the geometry used for computing the azimuth angle is also shown. Although computation of the azimuth angle is not required here, it is needed for, and discussed in, example 8.

---

<sup>60</sup> This is because the declination of the satellite is set to  $0^\circ$ , which causes several of the terms from a more general set of equations to disappear.

<sup>61</sup> M. Richharia. *Satellite Communications Systems, Second Edition*, New York; London: McGraw-Hill, 1999, page 37.

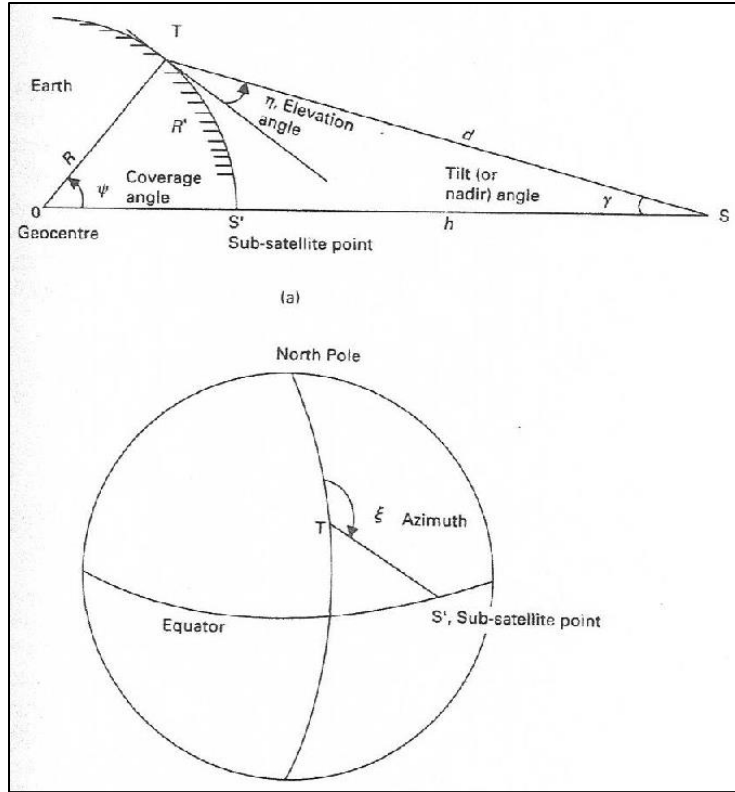

Figure F-2. Geometry of a Geostationary Link Showing (a) Elevation, (b) Azimuth from a Point T on the Earth

For Pax River, the latitude/longitude is approximately 38°N/76°W. Assuming an earth radius of 6358 km, a satellite orbital radius of 6358 km + 36,000 km, a satellite sub-orbital longitude (also known as Right Ascension) of 115.2°W, an OOB of -43 dBW/4kHz, and the maximum value of the FM-6 antenna gain of 34.7 dBi (from [Figure F-3](#)) yields:

$$\alpha_s = \arcsin[\cos(38^\circ)\cos(115.2^\circ - 76^\circ)] = 37.64^\circ \quad \text{F-6a}$$

$$\alpha = \arctan\left\{\frac{\sin(\alpha_s) - 6358\text{km}/42358\text{km}}{\cos(\alpha_s)}\right\} \quad \text{F-6b} \quad \text{F-6}$$

$$r = \sqrt{42358^2\text{km}^2 - 6358^2\text{km}^2\cos^2(30.18^\circ)} - 6358\text{km}\sin(30.18^\circ) = 38804\text{km} \quad \text{F-6c}$$

Contours shown in [Figure F-3](#) are -2, -4, -6, -8, -10, -15, and -20 dB relative to the beam peak of 34.7 dBi.

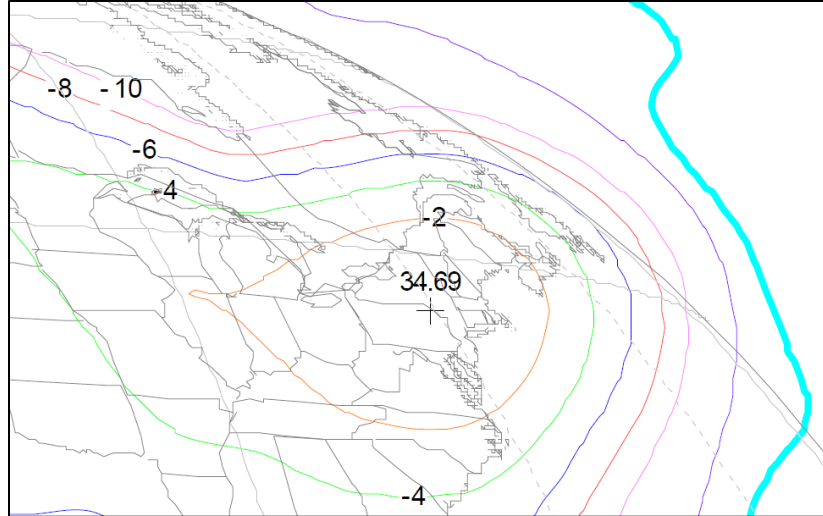

Figure F-3. Digital Audio Radio Service Downlink Beam Gain Contours

Thus, the elevation angle  $\alpha = 30.2^\circ$  and the distance  $r$  from the ground station to the satellite is 38,804 km. Using the Friis equation, we have a received PFD at the ground station  $PFD_{rec}$  of

$$\frac{P_T G_T}{4\pi r^2} = \frac{10^{-4.3} \times 10^{3.47}}{4\pi(38804 \times 10^3)^2} = -171 \text{ dBW}/m^2 \text{ in 4 kHz} \quad \text{F-7}$$

The upper S-band protection criteria provide three PFD protection values as a function of  $\alpha$ , as shown in [Table 2-7](#).

Thus, the relevant Rec M.1459 protection criterion for this example is the value for an interference angle of arrival  $>11.5^\circ$ , which is  $-162 \text{ dBW}/m^2$  in 4 kHz.

Since the OOBE fall below the maximum level stipulated by Rec M.1459 for this angle of arrival, there is no out-of-band interference from FM-6 to the AMT site at Pax River. Note that the derivation of this result required no information about the size, tower height, or pointing direction of the AMT antenna.

Repeating the computation for other ground stations is straightforward; however, since no analytic expression for the antenna gain of the satellite is available, the appropriate value of the gain of the satellite's downlink antenna must be obtained from [Figure F-3](#). [Figure F-4](#), which shows the angle of arrival of the signal from the satellite, provides a convenient check of the computation of  $\alpha$  from equations [F-5a](#) and [F-5b](#).

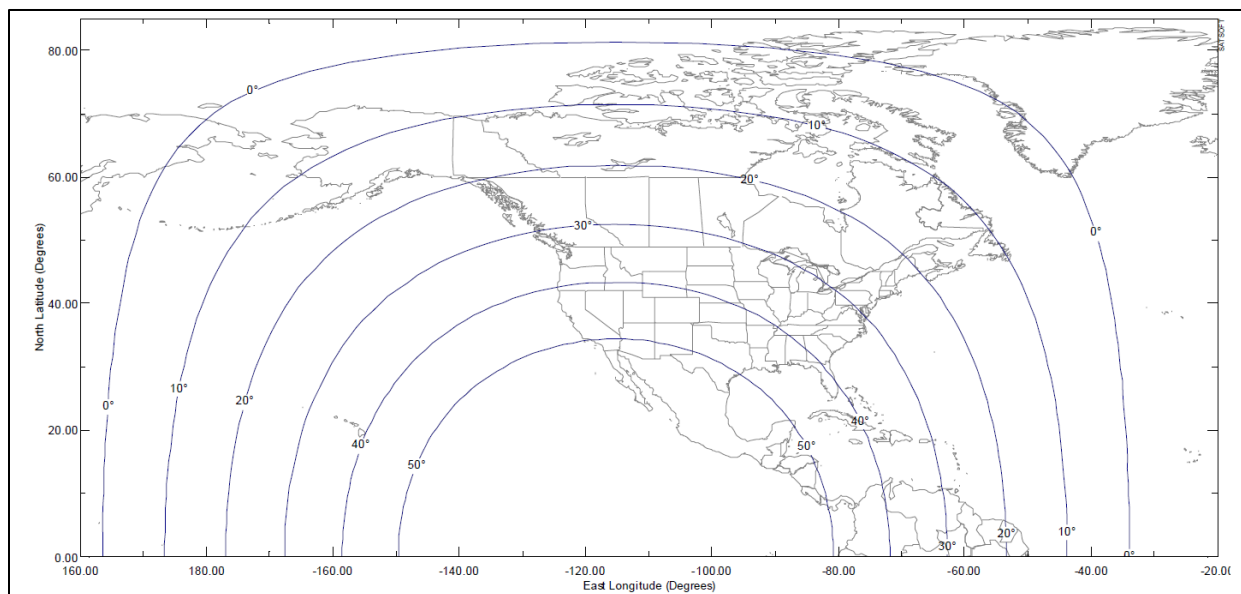

Figure F-4. Elevation Angles from Surface of the Earth to the 115.2° West Longitude Orbital Location

**Example 4.** Frequency scaling of interference and interference criteria to different reference bandwidths

As mentioned above, the reference bandwidth of 4 kHz for the PFD protection levels in Rec M.1459 is easily scaled to other values. This is done assuming that the required protection level is independent, of which 4 kHz of a typically 1 – 5 MHz AMT channel is affected.

This example must also take into account the reference bandwidths. For example, the permitted interference into a 1-MHz AMT channel is  $10^6/4000$  times the appropriate dB(W/m<sup>2</sup>) in 4 kHz protection level from the list above; however, the spectral density of the interference into, for example, a 5-MHz AMT channel at 1520 – 1525 MHz, may vary across the 5 MHz in question. In addition, the reference bandwidth specified for the protection criterion for a given frequency band may be as large as 27 MHz, which is the case for the EESS band from 1400 – 1427 MHz; however, the interference into the AMT band may be a function of frequency. This is the case for interference from the WCS service in 2345 – 2360 MHz (i.e., the band that separates SiriusXM from the AMT frequencies in the upper S-band from 2360 – 2395 MHz).

In Section 27.53 of its rules (cf. footnote 392 of the FCC’s Order on Reconsideration)<sup>62</sup>, the FCC stipulates that interference into the AMT band at 2360 – 2390 MHz from the WCS band at 2345 – 2360 MHz is to decrease as a function of frequency according to the following emission mask:

Specifically, WCS base and fixed stations’ OOB must be attenuated by a factor of not less than 43 + 10 log (P) dB in the 2360-2362.5 MHz band, 55 + 10 log (P) dB at 2362.5-2365 MHz band, 70 + 10 log (P) dB at 2365-2367.5 MHz band, 72

<sup>62</sup> Federal Communications Commission. “Amendment of Part 27 of the Commission’s Rules to Govern the Operations of Wireless Communications Services in the 2.3 GHz Band.” WT Docket No. 07-293. In *Order on Reconsideration*. FCC 12-130. 17 October 2012. Retrieved 17 May 2021. Available at [https://apps.fcc.gov/edocs\\_public/attachmatch/FCC-12-130A1.pdf](https://apps.fcc.gov/edocs_public/attachmatch/FCC-12-130A1.pdf).

+ 10 log (P) dB at 2367.5-2370 MHz band, and 75 + 10 log (P) dB above 2370 MHz. WCS mobile and portable devices' OOB E must be attenuated by a factor of not less than 43 + 10 log (P) dB at 2360-2365 MHz, and 70 + 10 log (P) dB above 2365 MHz. See 2010 WCS R&O, 25 FCC Rcd at 11766 para. 135, 11785 para. 182; 47 C.F.R. §§ 27.53(a)(1)(iii) and (4)(iii).

Figure F-5 shows the FCC-specified emissions profile in graphical form. The vertical axis represents  $xx + 10 \log(P)$  in dB.

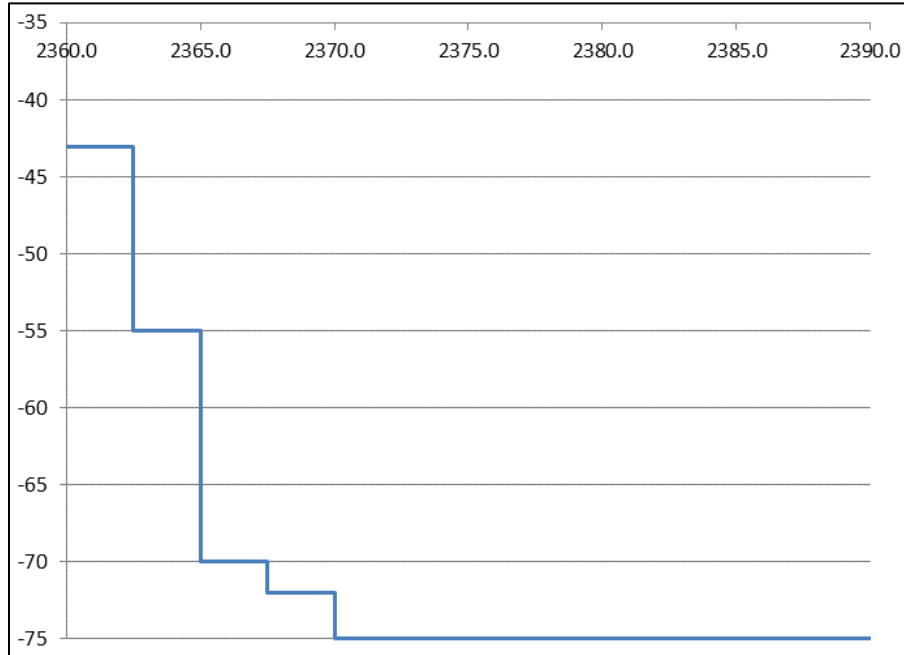

Figure F-5. FCC Emission Mask for the WCS OOB E Band from 2360 – 2390 MHz

The rule above provides the guidance on how to compute the net interference from a WCS transmitter into a 5-MHz AMT band, for example, operating at 2360 – 2365 MHz. The two OOB E levels, -43 dBW and -55 dBW are averaged according to the following equation:

$$\begin{aligned}
 & \text{OOBE in Watts per 4 kHz averaged across 5 MHz at (2360 – 2365 MHz)} \\
 & = G_{WCS\ xmt} \times \frac{4 \times 10^3}{5 \times 10^6} \times \left\{ \left( \frac{2.5}{5} \right) \times 10^{-4.3} + \left( \frac{2.5}{5} \right) \times 10^{-5.5} \right\}
 \end{aligned}
 \tag{F-8}$$

To convert from watts to dBW, the result of Equation F-8 is converted to a base ten logarithm and multiplied by 10, as usual.

Note that  $G_{WCS\ xmt}$  is the gain of the WCS transmit antenna in the direction of the AMT ground station antenna that is being considered. Equation F-8, the  $4E3/5E6$  term re-normalizes the average OOB E level across the 5-MHz-wide AMT channel width to the 4-kHz reference bandwidth of Rec M.1459.

Equation F-8 is the EIRP of the interfering WCS transmitter as measured at the aperture of the WCS transmit antenna. To compute the interference received at the aperture of the AMT

ground station antenna, it is necessary to include the path loss by using Equation F-1. It is necessary when using Equation F-1 to convert the path loss to dB or the EIRP from dBW to watts when using Equation F-1. For comparison with the protection levels of Rec M.1459, the result of Equation F-1 should be converted to dBW/m<sup>2</sup> in 4 kHz.

It is important to note that the OOB levels given above represent a “stair-step pattern”, where the OOB in each segment of spectrum (in this case, each 2.5-MHz segment) is constant. Actual OOB measurements, which are typically used for computations when available, decrease from one end of the band segment to the other. In order to average the OOB properly in these conditions, the 2.5-MHz segments are broken up into, for example, 0.1 to 1.0-MHz segments. These are then averaged using the methodology of Equation F-8, but with more terms inside the curly brackets. To determine whether the segments are narrow enough, it is sufficient to keep dividing the segments by a factor of 2 and then re-computing the OOB using Equation F-8. This is repeated until the end result is constant within the desired resolution of the computation (e.g., 0.1 dB).

Figure F-6 illustrates the difference between the stair-step emissions masks published by the FCC and by an industry group, in this case the Third Generation Partnership Project, or 3GPP consortium. Figure F-6 also shows the simulated in-band and OOB of a 4G LTE-A handset uplink as a function of the number of resource blocks assigned to a particular signal.

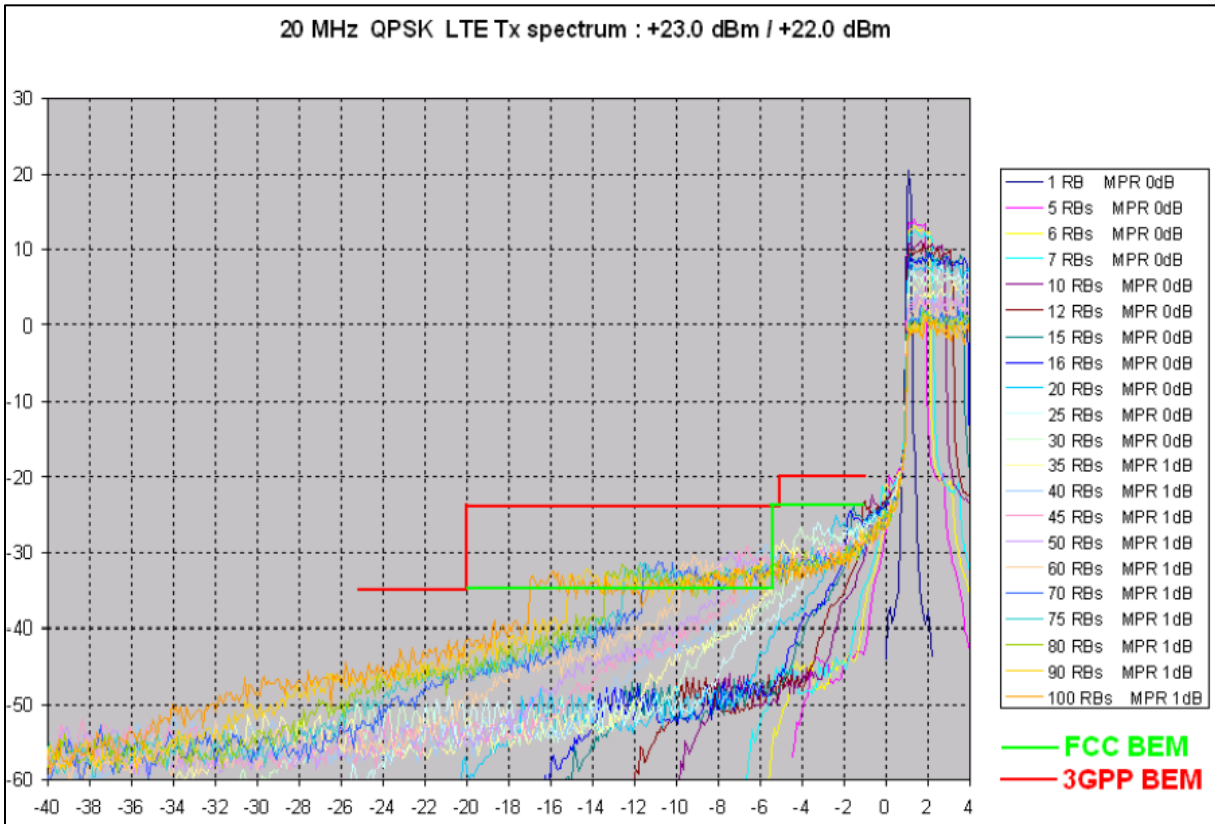

Figure F-6. Simulated OOB Emissions from an LTE Handset<sup>63</sup>

<sup>63</sup> Wireless Communications Association. “4G Device Out of Band Emissions and Larger Channel Bandwidths,” October 2011. Retrieved 17 May 2021. Available at <https://ecfsapi.fcc.gov/file/7021715550.pdf>.



It is useful to work the problem of OOB from aircraft AMT transmitters into the EESS spectrum from 1400 – 1427 MHz. Resolution 750<sup>64</sup> stipulates that the net radiated OOB from an AMT transmitter operating in the band 1429 – 1452 MHz (not including the gain of its antenna), when averaged over the entire 27-MHz EESS band,<sup>65</sup> should not exceed a power level of –28 dBW.

[Chapter 2](#) stipulates that the OOB in any 1 MHz from an AMT transmitter be attenuated by an amount of at least  $55 + 10 \log(P)$  dBW. When scaled to a bandwidth of 27 MHz, an additional  $10 \log(27 \text{ MHz}/1 \text{ MHz}) = 14.3$  dB must be added to the –55 dBW OOB level. This yields an OOB of –41 dBW per 27 MHz, which is well below the requirement of Resolution 750.

The point here is that when scaling from one reference bandwidth to another, at least some insight into the context of the problem is needed. Simply applying the same rule, by rote, from one scenario to another can lead to errors.

**Example 5:** Computation of path loss using the two-ray model

For computing interference to an AMT ground station from terrestrial sources, it is necessary to include the effects of terrain, the curvature of the earth, ground reflections, Fresnel zone impingement, etc. All of these effects can be lumped into the value of path loss that is defined by Equation [F-2](#).

With the exception of what is known as the two-ray model, consideration of these effects in a path loss computation requires, in addition to antenna height information and the distance between the interferer and victim receiver, an accurate terrain database (i.e., a topographical map of the path between the interference source and the AMT site). Other effects, such as additional path loss caused by buildings and other clutter, can be included as long as the details of such loss are justified by measurements and databases whose accuracy and precision go well beyond the 1 arc-second (30 meter) resolution that is typically used for path loss modeling at this time.

The two-ray model treats the ground as a reflector, and takes into account the interference nulls caused by this reflection that occur at various distances and heights from the transmitting aircraft or interference source. [Figure F-7](#) shows this graphically. When a resulting null coincides in position with the aperture of the AMT receive antenna, a significant signal fade (15 – 30 dB) occurs. Depending on the bandwidth of the signal, the fade can cause attenuation across the entire bandwidth of the signal, or can cause just a portion of the signal bandwidth to suffer a reduction in received signal power.

---

<sup>64</sup> International Telecommunications Union. “Compatibility between the Earth exploration-satellite service (passive) and relevant active services.” *Final Acts WRC-15 – World Radiocommunication Conference*. Geneva, 2015. pp. 399-403.

<sup>65</sup> The wideband radiometric sensors aboard EESS satellites apparently receive signals across the entire 27 MHz of the band at once, with no effort made to determine where in the band a signal originates.

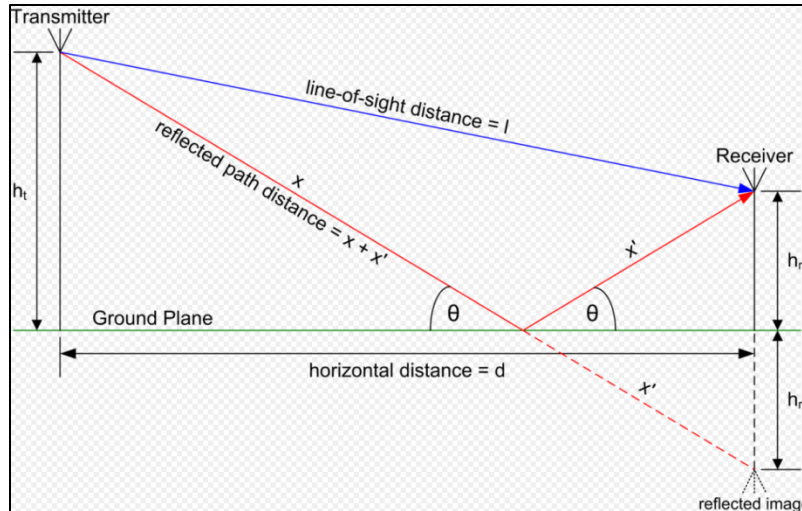

Figure F-7. Graphical Representation of the Two-Ray Model

Reflection can also cause enhancement of the received signal (or interference); however, for a two-ray, as opposed to three-or-more-ray model, this enhancement cannot exceed 3 dB. As noted, the fades can always be considerably larger than 3 dB in their amplitude. In fact, for aircraft, fades can occur not only from ground reflection of the telemetry signal, but from unwanted reflections of the telemetry signal from aircraft structures or from blockage of the direct signal path from the aircraft antenna to the ground station during aircraft maneuvers.

Since an aircraft in flight is constantly moving, telemetry signal fades are strong functions of time. For modeling purposes, this time dependence is characterized by a change in the availability of the telemetry link. This is a key feature of Rec M.1459, and is the subject of example 6.

For static interferers, such as interference from a cellular tower, fades can be regarded as being constant, and are accounted for in the path loss software.

A graphical representation of path loss versus distance of the two-ray model is shown in [Figure F-8](#).<sup>66</sup> Note that the fades are deep and the signal enhancements are shallow. It is important to understand that the graph is for a particular combination of tower heights and signal wavelength.

<sup>66</sup> Thomas Schwengler. "Radio Propagation Modeling." Chapter 3 in *Wireless and Cellular Communications*. Retrieved 17 May 2021. Available at <http://morse.colorado.edu/~tlen5510/text/classwebch3.html>.

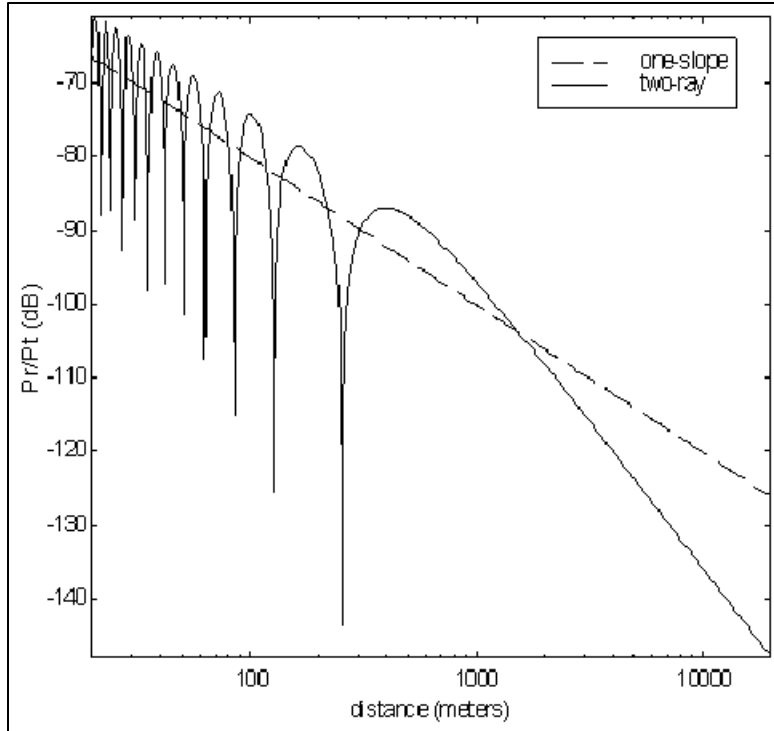

Figure F-8. Comparison of Free-Space One-Slope and Two-Ray Propagation Models

Fades are most prominent near the transmitter. For example, the two-ray model is evident on airport aprons when a telemetry test cart is used to receive TM signals from an aircraft parked several hundred feet away. More importantly, the long-range reduction in signal strength for the two-ray model falls faster than the  $1/r^2$  (i.e., 20 dB per decade of frequency) of the free-space single-ray signal. The  $1/r^4$  roll-off of the two-ray model is 40 dB per decade.

The equations for computing the two-ray model can be found online, in text books, or from direct computation. If path loss software is available, it is convenient to compute the two-ray results for a particular situation by setting the terrain height to zero and using the default value of ground electrical conductivity provided by the software.

Although the equations for the two-ray model can be rather daunting, in its simplest form, one uses flat-earth trigonometry to compute the difference in path lengths between the direct and reflected signals. This depends on the horizontal distance  $d$ , the altitude of the aircraft  $h_t$ , and the height above ground of the AMT receive antenna,  $h_r$ . Using trigonometry and assuming that the signal is reflected from the ground and/or sea with a reflection coefficient of magnitude 1, the aircraft altitudes and locations can be computed for which positive and negative signal reinforcement due to multipath occur. When the direct path and the reflected path differ by an even number of signal half-wavelengths  $\lambda/2$ , signal reinforcement occurs. When they differ by an odd number of half-wavelengths, deep fades occur.

For reflections from a smooth ocean surface, the conductivity of salt water can be used; however, Rec M.1459 anticipates this, and most interference to AMT ground station paths are not over water. Hence, the default value for ground conductivity is typically the correct value to use.

The equation for computing the curve shown in [Figure F-8](#) is given by

$$p_0(t) = \sqrt{(G_t G_r)} \frac{\lambda}{4\pi} \left( \frac{\exp(j2\pi l_0/\lambda)}{l_0} + \Gamma \frac{\exp(j2\pi l'_0/\lambda)}{l'_0} \right) \quad \text{F-9}$$

Where  $l_0$  and  $l'_0$  are the line-of-sight (LOS) distances  $l$  and  $x + x'$  shown in [Figure F-7](#).

With respect to the phrase “direct line of sight”, it is convenient to note that this is computed as

$$D_{LOS} = \sqrt{2h_1 R_{earth} \times 4/3} + \sqrt{2h_2 R_{earth} \times 4/3} \quad \text{F-10}$$

where  $h_1$  and  $h_2$  are the heights of the transmit and receive antennas,  $R_{earth}$  is the nominal radius of the earth of 6358 km, and the factor of 4/3 accounts for atmospheric refraction.

**Example 6.** Rayleigh fading of the aircraft telemetry signal

There is a generalization of the two-ray model that adds the effects of reflections of the telemetry signal from aircraft structures and/or blockage of the telemetry signal by these same structures during aircraft maneuvers. This is Rayleigh scattering that plays an important role in the technical details of Rec M.1459. The resulting Rayleigh distribution can be used to predict the percentage of time that the link margin of any air-to-ground telemetry link will fall below the threshold value needed for the link to be viable. This is illustrated by [Figure F-9](#), [Figure F-10](#), and [Figure F-11](#).

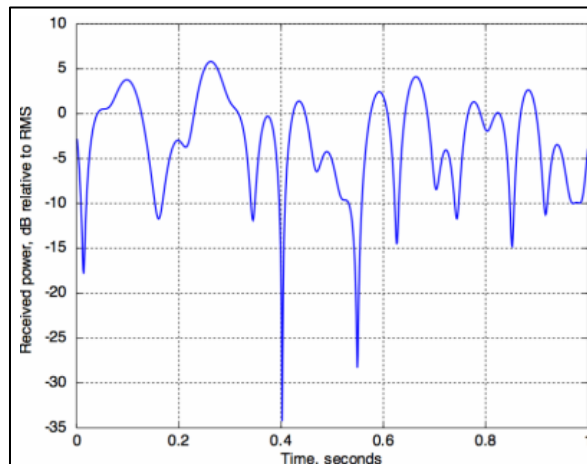

Figure F-9. Rayleigh Fading of a Signal Transmitted from a Moving Platform<sup>67</sup>

<sup>67</sup> Wikipedia. “Rayleigh fading.” Retrieved 17 May 2021. Available at [https://en.wikipedia.org/wiki/Rayleigh\\_fading](https://en.wikipedia.org/wiki/Rayleigh_fading)

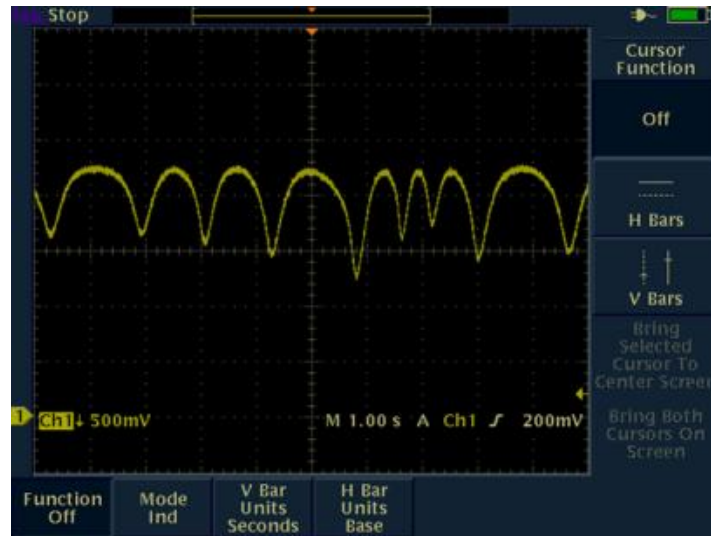

Figure F-10. S-band Telemetry Signal Received from an Aircraft in Flight<sup>68</sup>

<sup>68</sup> D.G. Jablonski. "Demonstration of Closed Loop Steering of Antenna Patterns for Mitigating Antenna-to-Antenna Interference in Two-Antenna Telemetry Installations on Military Aircraft," Instrumentation Test Technical Symposium, New Orleans, LA, 25 August 2004.

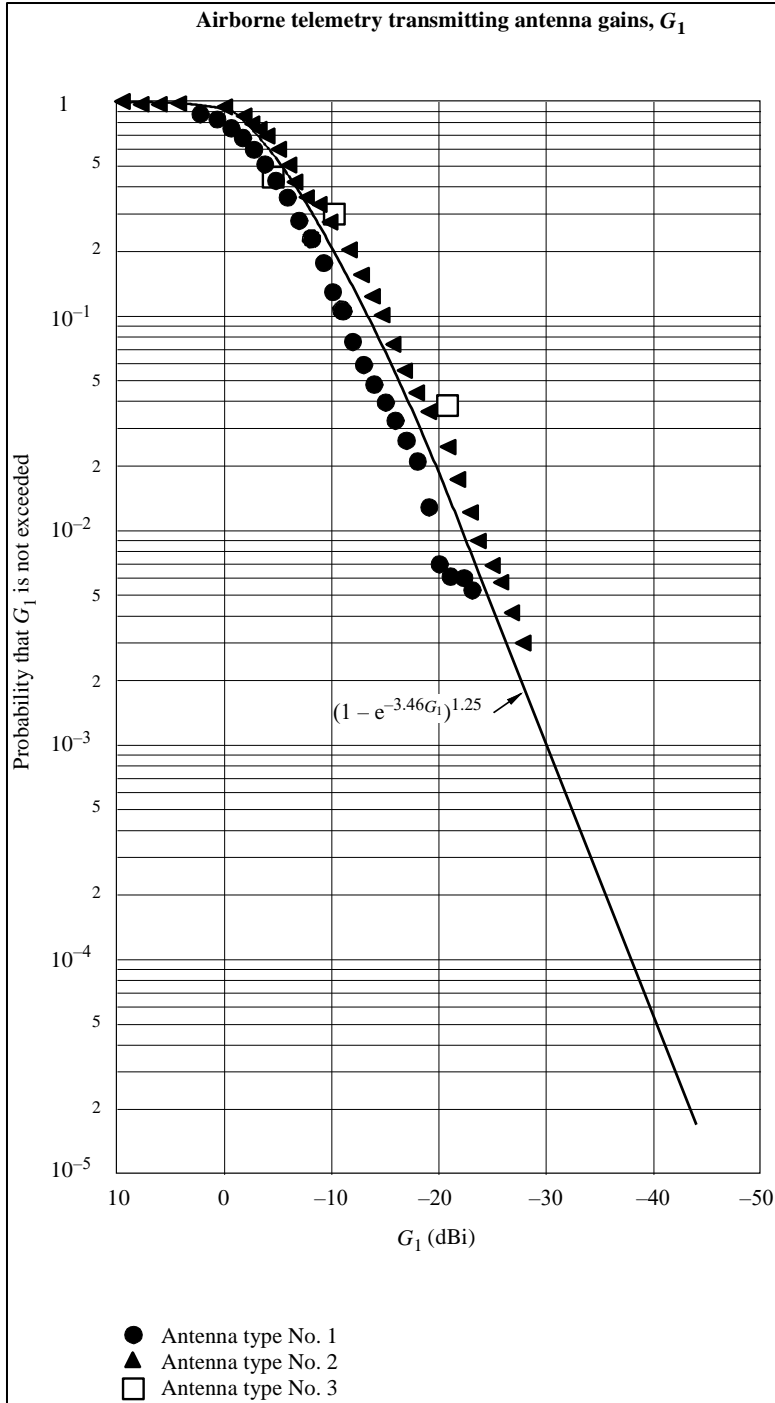

Figure F-11. Rayleigh Distribution as Presented in Figure 2 of Rec M.1459 (Jablonski 2004)

[Figure F-9](#) is a one-second time slice of the strength of a Rayleigh-faded signal as received from a moving transmitter. [Figure F-10](#) is the measured signal strength of a Rayleigh-faded aircraft telemetry signal as a function of time as received at an AMT ground station.

[Figure F-11](#) relates the depth of a fade to a numerical value of the probability as a percentage of time that such a fade will occur. The mathematical expression given in the figure is

an essential component of the computations of the Rec M.1459 protection criteria. Specifically, the Rayleigh distribution provides the connection between interference and link availability. This is an extension of less-sophisticated link budgets that consider only the effect of interference on BER, without considering whether the interference will cause the link to fail completely.

Note that the Rayleigh distribution presented above is typically used in AMT link budget computations by including the fade in the instantaneous value of the gain  $G_{xmt}$  of the aircraft telemetry transmit antenna, as opposed to including it as a component of the path loss. This keeps the consideration of fading due to aircraft geometry and motion independent of the consideration of terrain effects (described below), for which Rayleigh scattering is typically not relevant.

Rec M.1459 requires a threshold signal-to-noise value of  $(C/N)_T$  of 15 dB. For the AMT system values specified in Rec M.1459, the AMT channel bandwidth is 3 MHz and the system noise temperature is 250 Kelvin. The required AMT telemetry signal receive power is

$$C = kTB \times 10^{1.5} = 1.38 \times \frac{10^{-23} \text{ Joule}}{\text{Kelvin}} \times 250 \text{ Kelvin} \times (3 \times 10^6 \text{ Hz}) = \quad \text{F-11a}$$

$$3.27 \times 10^{-13} \text{ Watts} = -124.85 \text{ dBW}.$$

The corresponding expression for the Friis equation for an aircraft antenna transmit gain of  $-25$  dB and including the effective area of  $\lambda^2 G_{rec}/4\pi$  of the AMT ground station receive antenna with  $P_T = 3\text{W}$ ,  $G_{rec} = 41.2$  dB,  $r = 320$  km, and  $\lambda = 0.2$  meter (per Rec M.1459) is

$$\frac{P_T G_T \lambda^2 G_{rec}}{(4\pi r)^2} = \frac{3 \times 10^{-2.5} \times (2)^2 \times 10^{4.12}}{(4\pi)^2 \times (320 \times 10^3)^2} = 3.09 \times 10^{-13} \text{ Watts} = -125.10 \text{ dBW} \quad \text{F-11b}$$

**Example 7:** Computation of path loss using commercial software that implements the L-R/ITM and P.452 models

Since the two-ray model is seldom adequate for predicting path loss over terrain, a wide assortment of models that include the effects of terrain has been developed. These are based on different combinations of assumptions regarding reflection, refraction, diffraction, signal blockage, Fresnel zone impingement, etc., and are available with terrain databases already included. These include several, such as Terrain-Integrated Rough-Earth Model, L-R, ITM, and Free-space plus reflection and multiple diffraction.

Another category of models is contained in ITU-R recommendations that are similar in structure to Rec M.1459. Three of the most important models are:

- P.452-16: Prediction procedure for the evaluation of interference between stations on the surface of the Earth at frequencies above about 0.1 GHz;<sup>69</sup>
- P.1546: Method for point-to-area predictions for terrestrial services in the frequency range 30 MHz to 4000 MHz;<sup>70</sup>

<sup>69</sup> International Telecommunication Union. "Prediction procedure for the evaluation of interference between stations on the surface of the Earth at frequencies above about 0.1 GHz." ITU-R Recommendation P.452-16. July 2015. May be superseded by update. Retrieved 17 May 2021. Available at <https://www.itu.int/rec/R-REC-P.452/en>.

<sup>70</sup> International Telecommunication Union. "Method for point-to-area predictions for terrestrial services in the frequency range 30 MHz to 3 000 MHz." ITU-R Recommendation P.1546-6. August 2019. May be superseded by update. Retrieved 17 May 2021. Available at <https://www.itu.int/rec/R-REC-P.1546/en>.

- P.528: Propagation curves for aeronautical mobile and radionavigation services using the VHF, UHF, and SHF bands.<sup>71</sup>

As this example only makes use of the L-R/ITM and P.452 models, information regarding the other two models is excluded from this document. The P.452 model can be regarded as the internationally approved version of the ITM, which is an outgrowth of the L-R model. The ITM and L-R models were developed for domestic purposes by the United States at the National Institute of Standards and Technology. Because of the need for technical studies presented to the ITU to utilize ITU-sanctioned models, P.452 has become the de facto standard for domestic studies that require path loss computations based on actual terrain.

In order to use P.452, it is necessary to purchase a commercial software package such as EDX Signal Pro (favored by the AMT community at the present time), ATOLL (used by cellular carriers), or Visualyse (used by those who need to consider platform motion and the time-dependent effects of this on interference). Such commercial packages typically include most, and sometimes all, of the models listed here.

There is also a non-commercial version of P.452, in the form of macro-enabled Excel spreadsheets, that is available free of charge from the ITU at [www.itu.int](http://www.itu.int). It models the effects of terrain using data imported from, readily available terrain databases.

For AMT, the fundamental terrain database is usually the government-provided, freely available USGS 1 arc-second (30 meter) resolution topographic map data. The Shuttle Radar Topography Mission database is sometimes used, although it is comprised of overhead measurements, and its validity for computing point-to-point path loss is sometimes questioned.

It is important to consider how accurate these propagation models are. A comparison study<sup>72</sup> suggests that error bars of 15 dB in the path loss computation are typical. Perhaps a better approach is to use existing measurement data from NTIA,<sup>73</sup> which exist in the form of five separate studies that are available from the Defense Technical Information Center. It is straightforward to insert the location, frequency, and antenna height details provided in the studies into any of the commercial models for comparison purposes.

[Figure F-12](#) and [Figure F-13](#) illustrate how data obtained using a commercial package, in this case EDX Signal Pro, are presented for a series of point-to-point links between cellular towers and an AMT receive site at Pax River. The purpose of the simulation is to compute path loss values from each of the cellular sites to the AMT ground station. The assumption that Pax River is the transmitter site is a feature of the software package's point-to-multipoint analysis routine. Since the purpose of the analysis is to compute a value for the path loss for each link, including the effects of terrain, reversing the roles of transmitter and receiver is of no numerical consequence.

---

<sup>71</sup> International Telecommunication Union. "Propagation curves for aeronautical mobile and radionavigation services using the VHF, UHF, and SHF bands." ITU-R Recommendation P.528-4. August 2019. May be superseded by update. Retrieved 17 May 2021. Available at <https://www.itu.int/rec/R-REC-P.528/en>.

<sup>72</sup> Phillips, C., D. Sicker, and D. Grunwald. "Bounding the Practical Error of Path Loss Models." International Journal of Antennas and Propagation, Volume 2012 (2012). Retrieved 17 May 2021. Available at <https://www.hindawi.com/journals/ijap/2012/754158/>.

<sup>73</sup> For example, Hufford, G. A. and F. K. Steele. "Tabulations of Propagation Data over Irregular Terrain in the 75-To 8400-Mhz Frequency Range - Part V: Virginia." NTIA Publication 91-282, December 1991. Retrieved 17 May 2021. Available at <https://www.its.blrdoc.gov/publications/download/91-282.pdf>.



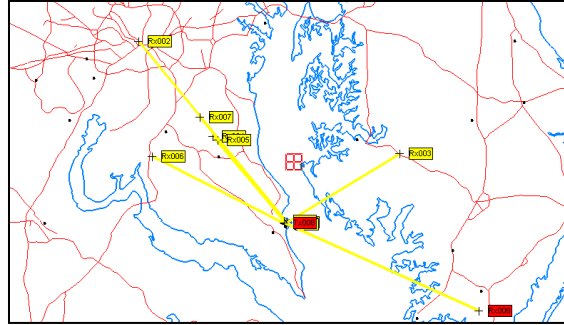

Figure F-12. EDX Signal Pro Map of Hypothetical Transmitters and Receivers in the Pax River Region

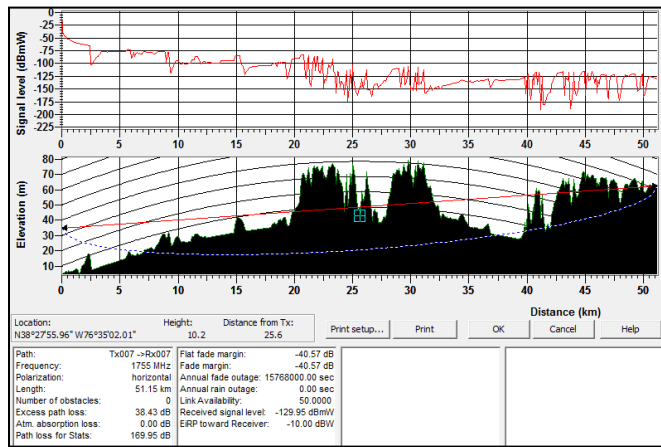

Figure F-13. EDX Signal Pro Path Loss Profile for the TX007 to RX007 Path

The simulation results of [Figure F-12](#) and [Figure F-13](#) are followed in [Figure F-14](#) by experimental data measured by NTIA engineers and reported in Hufford and Steele.

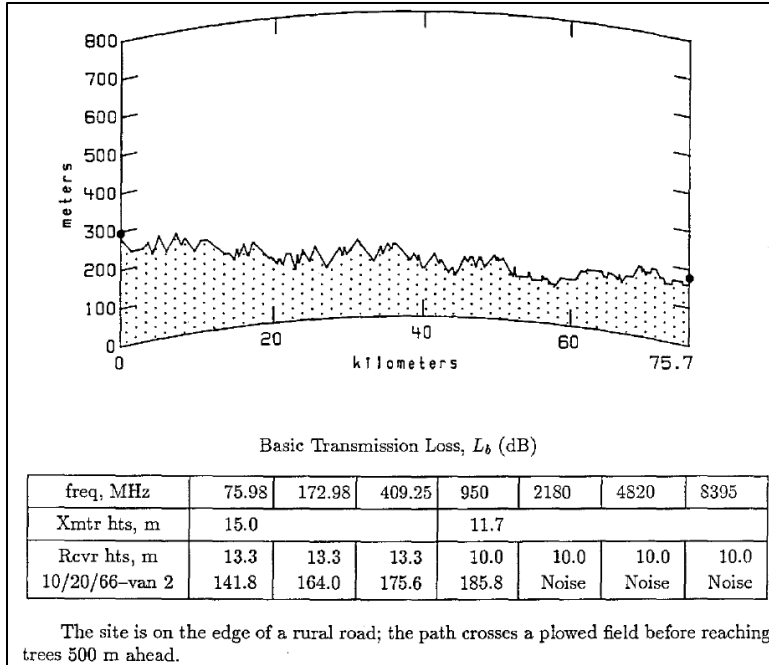

Figure F-14. Actual Measured Path Loss Data from an NTIA Report (Hufford and Steele)

Figure F-12 is a map showing various point-to-point transmitter-to-receiver links, TX001 to RX001, TX002 to RX002, etc. On the map, the same geographic location is used for all the transmitters, with the active transmitter for the example analysis (TX008) displayed on top of the other transmitters. Map data such as this is essential for computing aggregate interference as a function of bearing angle to an AMT site.

Figure F-13 shows the terrain profile, including the effects of the earth’s curvature, for the TX007-to-RX007 data link. The path loss, computed in this example using the L-R model, is 169.95 dB. The dashed blue line represents the extent of the Fresnel zone, showing how the terrain blockage impinges the zone, thus creating excess path loss.

For these simulations, it is typically appropriate to use average value settings for parameters related to variability. Although actual values for terrain blockage are used throughout the simulation, it is necessary to make a similar (e.g., average) assumption about whether diffraction due to terrain is modeled as knife-edge versus smooth-edge model.

In any case, it is important to validate model simulations using actual measurements wherever possible. This is the purpose of including Figure F-14, which is an example path profile from the many measurements made by NTIA.

The terrain data in Figure F-14 was obtained from manual inspection of a topographic map by members of the NTIA team, and was hand-entered into the graphing software used for preparing the measurement report. This is an important point. In interference studies, it is often the case that only a few cellular towers or other interference sources cause the aggregate level of interference to exceed Rec M.1459 limits. It is possible to re-create the data used in a commercial package by reference to a local topographic map and enter the data in the ITU-R

P.452 spreadsheet for analysis. The results are as accurate as those produced by the expensive packages, but can be obtained by using Excel spreadsheets.

Given the major effort required to collect experimental data, it is generally not practical to make measurements at all of the frequencies of interest with respect to interference computation. It might well be the case that the path loss at 1500 MHz, rather than the loss at the measured frequency of 2180 MHz, is the value of interest.

Since the wavelength is a component of the path loss value, and since the wavelength depends on the signal frequency, it is necessary to consider how to convert a measurement made at one frequency to an estimate of path loss at a different, but relatively close, value of frequency, such as the 2180-MHz to 1500-MHz example given here.

To a first approximation, path loss is independent of frequency in the 1 – 6 GHz bands, although effects of building attenuation are significant and signal absorption by foliage becomes important at the higher end of this frequency range. At even higher frequencies, such as the 12.6-MHz carrier frequency used for satellite television downlinks, foliage and rain attenuation are both significant. At even higher frequencies atmospheric absorption due to water vapor is extremely important, and care is often taken to operate in windows in the 35-GHz and 90-GHz ranges.

The explicit inclusion of a value for  $\lambda$  in Equation [F-2](#) for the path loss is a computational artifact. In the Friis equation, it more properly connects the gain  $G_{rec}$  of the receive antenna to its effective area  $\lambda^2 G_{rec}/4\pi$ . Shifting  $\lambda^2$  from the effective area to the path loss portion of the equation makes the path loss a dimensionless parameter, which is necessary in order for its value to be specified in dB.

Thus, when a path loss value for 2180 MHz is used as an estimate for the path loss at 1500 MHz, it is necessary to correct the path loss value using Equation [F-12](#).

$$path\ loss_{1500} = \left( \lambda_{1500} / \lambda_{2180} \right)^2 \times path\ loss_{2180} \quad F-12$$

**Example 8.** Consideration of the antenna patterns of terrestrial cellular base stations

It is necessary to know specific details of the gain pattern, location, height above ground, and pointing direction of the interfering antenna in order to replicate the computation for the case of a terrestrial interferer. If the terrestrial interferer is a cellular tower that hosts multiple sectored antennas, this requires specific knowledge about the antennas that are used and how their electronic adjustments, specifically electrical down-tilt, are configured.

This example requires the equation for computing the bearing angle from a cellular tower to an AMT site, and vice versa, when the latitude and longitude of each are specified. This is done using the mathematics of spherical trigonometry for the great circle arc that leads from one site to the other.

Then, using the sector antenna pointing angles relative to true north, the gain of each sectoral antenna on the tower in the direction of the AMT site is derived. The gain of tower-mounted cellular antennas may be specified as two pattern files, one for a 360° horizontal sweep at 0° elevation, and one for a 360° vertical sweep at zero degrees of azimuth with respect to the main lobe of the antenna.

To further complicate the problem, the main beam of each sectoral antenna can be pointed downward by varying increments of angle (e.g., 0 – 9 degrees) by remote control using the electrical down-tilt feature of the antenna. For the cellular antennas of interest, each permissible value of down-tilt is accompanied by its own pair of pattern files.

Mechanical down-tilt can also be used. This requires modifying the indexing of entries in the vertical file for the antenna so that, for example, the vertical pattern gain entries are shifted by the amount of the mechanical down-tilt.

The purpose of down-tilt is to permit adjustment of patterns to improve coverage of a typically urban or suburban area as new, additional cellular towers are in-filled, e.g., when a network is expanded to maintain coverage while increasing capacity.

In any case, it is necessary to combine the two-dimensional horizontal and vertical patterns into a single three-dimensional pattern using an interpolation algorithm. Manufacturers of cellular antennas of interest are not the main source of advice on how to do this. Instead, the academic literature summarizes and compares four different algorithms. These are called:

- Arithmetic mean;
- Bi-linear interpolation;
- Weighted bi-linear transformation;
- Horizontal projected interpolation.

With respect to the antenna pattern files,  $G_{vert}$  and  $G_{horiz}$ ,  $\theta$  represents elevation (with positive  $\theta$  in the downward direction from  $\theta = 0$  at the horizon) and the azimuth  $\phi$  equals 0 in the center of the main lobe (with positive  $\phi$  going counterclockwise as viewed from above).<sup>74</sup>

The formula for the arithmetic mean is the simplest, and is given by:

$$G(\theta, \phi) = 1/2 (G_{vert}(\theta) + G_{horiz}(\phi)) \quad \text{F-13}$$

The equations for the second and third algorithms are rather complicated, and are not repeated here.

The final algorithm, horizontal projected interpolation, is used by one of the major commercial software packages. It has also been incorporated into an AFTRCC-developed production-grade interference analysis software package. The algorithm is given by:

$$G(\phi, \theta) = G_h(\phi) - \left[ \frac{\pi - |\phi|}{\pi} \cdot (G_h(0) - G_v(\theta)) + \frac{|\phi|}{\pi} \cdot (G_h(\pi) - G_v(\pi - \theta)) \right] \quad \text{F-14}$$

It is necessary to determine the appropriate values of  $\phi$  and  $\theta$  to use the interpolation algorithms. These are often generated by the software package that is used to compute the path loss between the AMT site and the individual cellular tower. Typically, the elevation angle  $\theta$  is close enough to being horizontal that it can be assumed to be zero. Given that the angular resolution of the pattern files is only one degree and that  $G_v(0^\circ)$  is approximately equal to  $G_v(1^\circ)$ , this is a reasonable approximation.

---

<sup>74</sup> Sign conventions for  $\theta$  and  $\phi$  should be verified for each case by inspection of the antenna files and cross-checking with the manufacturer's data sheets.

Even when the azimuth angle  $\phi$  is produced by the path loss software, it is helpful to use the formula below to confirm that no data entry errors that would change the value of azimuth have occurred. This is done using the following formula from spherical trigonometry:

$$\sin(\phi) = \frac{\cos(\text{latitude}_{AMT})}{\sin\left(\frac{(\text{Distance}_{cell-AMT})}{R_{earth}}\right)} \cdot \sin(\text{longitude}_{cell} - \text{longitude}_{AMT}) \quad \text{F-15}$$

Note that  $\phi$  represents the azimuth angle from the cellular tower to the AMT ground station antenna. For computing the gain of the cellular antenna in the direction of the AMT antenna, the direction that each sectoral antenna mounted on the tower is pointed with respect to north must be added (or subtracted, as appropriate) to compute the sectoral antenna's bearing to the AMT ground station.

As shown in the next example, when computing aggregate interference from an ensemble of cellular towers, it is necessary to compute the bearing of the AMT site to each cellular tower and the angular offset of this bearing from the main lobe of the AMT antenna. This is done by reversing the roles of the AMT site and the cellular tower in the above equation.

Alternatively, the reverse bearing can be computed directly from  $\phi$  for the cellular tower, but certain quadrant conventions are needed in order to resolve ambiguities between the bearing angle  $\phi_{amt}$  and its complement  $180 - \phi_{amt}$ . This issue is typically discussed in basic satellite communication textbooks, and is resolved by depicting a simple drawing of the cellular tower and AMT site locations on a chart. When processing hundreds of tower-to-AMT locations at once, the quadrant correction must be programmed carefully.

As always, care must be taken to not inadvertently default to the equations of flat-earth trigonometry. In this limit, the elevation angles to an aircraft from a cellular tower are always overstated, leading to a misapplication of the Rec M.1459 protection criteria.

Example pattern files can be found online.<sup>75</sup> It is common for the files to give a maximum value of the gain at the center of the main beam of the pattern. The file entries then correspond to the relative attenuation of the pattern relative to this value of  $G_{max}$ .

**Example 9.** Aggregation of interference from a network of cellular base stations to one or more AMT ground stations<sup>76</sup>

The large-scale simulation of interference from thousands of cellular base stations and their associated handsets will be a major activity for both the civil and DoD AMT communities as government spectrum is auctioned for use by commercial broadband carriers. This example presents a stand-alone, step-by-step procedure for accomplishing this. It can be implemented in a variety of ways, including as a collection of Excel spreadsheets in conjunction with the commercial software packages (e.g., EDX Signal Pro) referenced earlier in this appendix.

The steps for completing a coordination of a large collection of emitters with a single AMT ground station are as follows.

<sup>75</sup> CommScope. "Calculators and Tools." Retrieved 17 May 2021.  
<http://www.commscope.com/Resources/Calculators/>.

<sup>76</sup> Analysis of the aggregation of handsets requires the inclusion of statistical parameters that are developed in example 10. The analysis of an aggregation of handsets is provided in example 12.

1. The composite AMT ground station antenna pattern provided by equations 1(a) – 1(f) of Rec M. 1459<sup>77</sup> is used instead of patterns obtained on a site-specific basis for each of the hundreds of AMT ground stations in the United States. This composite pattern is shown in [Figure F-15](#). Use of this composite antenna pattern addresses several features unique to AMT operations and eliminates the need for detailed, site-specific technical details that are subject to change from one flight-test program to another, or even during individual test flights. The Rec M. 1459 pattern is to be used in lieu of, for example, the Wolfgain and Statgain patterns given in NTIA Report TM-13-489<sup>78</sup>, although the Rec M. 1459 composite patterns are closely related to the Statgain patterns, as shown later in this appendix.

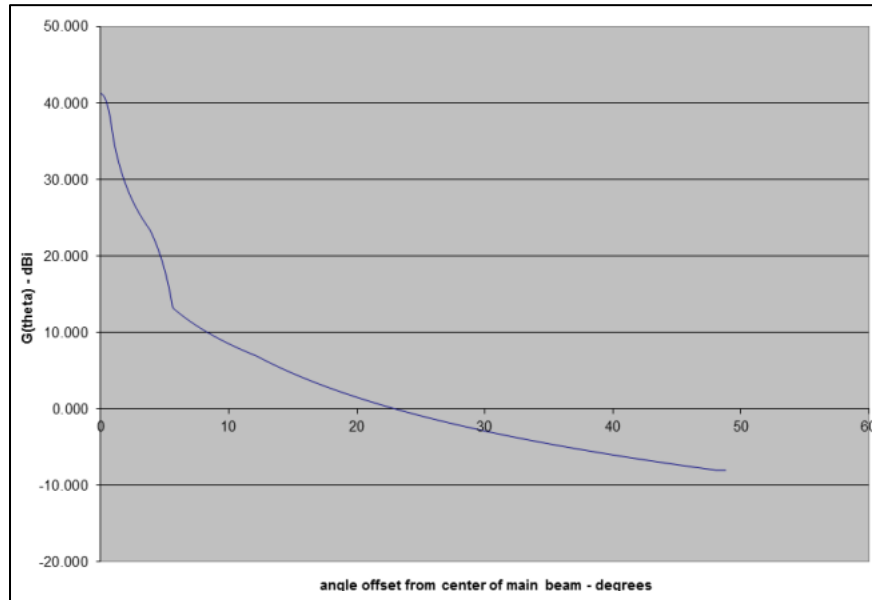

Figure F-15. Composite AMT Pattern from Rec M.1459

2. Instead of traditional interference-to-noise ratio (I/N) criteria, interference received at an AMT ground station is to be computed using the appropriate PFD limit from Rec M.1459. For example, this might be the Rec M. 1459 PFD limit for 0 – 2° angles of arrival (with respect to the horizon) for L or S bands, namely –180 or –181 dB W/m<sup>2</sup> in 4 kHz. These levels represent the total permitted aggregate interference, as computed using the technique given in steps 3 - 5.

3. It is necessary to consider the interference from all directions with respect to the ground station antenna, including interference received through the side lobes and back lobes to compute aggregate interference. Furthermore, this aggregate interference must be recomputed for all possible pointing angles (in azimuth) of the AMT ground station antenna, which can rotate to point in any direction. It would be appropriate, for example, to compute aggregate interference for each of 720 pointing angles, measured in 0.5° increments.

4. To compute aggregate interference from hundreds of base stations, for example, it is necessary to group the eNodeBs into 0.5°-wide azimuth-of-arrival wedges, then to compute the

<sup>77</sup> The antenna pattern shown in Figure 1 of Rec M.1459 is not the pattern to be used here.

<sup>78</sup> Wang, C. W. and T. Keech. *Antenna Models For Electromagnetic Compatibility Analyses*, NTIA Report TM-13-489. October 2012. Retrieved 17 May 2021. Available at <https://www.ntia.doc.gov/report/2012/antenna-models-electromagnetic-compatibility-analyses>.

aggregate PFD per wedge for each of these for each of 720 possible pointing angles of the AMT ground station. The aggregate PFD values for each wedge are converted in a received power value using the composite AMT ground station antenna pattern. This pattern, including values for side lobes and back lobes, provides the necessary weighting factors for converting PFD values in  $\text{W}/\text{m}^2$  to absolute power in watts (cf. equations [F-1](#) - [F-3](#)).

5. The aggregate power levels for each azimuth-of-arrival wedge are summed for all of the wedges into a single value. This aggregate value is computed for each of the 720 possible pointing angles of the AMT ground station antenna. Each of these 720 values is then converted back into a PFD level and compared with the PFD limit of  $-180$  or  $-181$   $\text{dBW}/\text{m}^2$  in 4 kHz. This yields a graph and/or table of interference values versus azimuth for the AMT ground station, as shown in notional form in [Figure F-16](#). Note that the scaling of the full bandwidth of the co-channel or adjacent channel interference to the 4-kHz reference bandwidth of the Rec M.1459 protection criteria uses the same linear transformation that is used for a traditional I/N analysis.

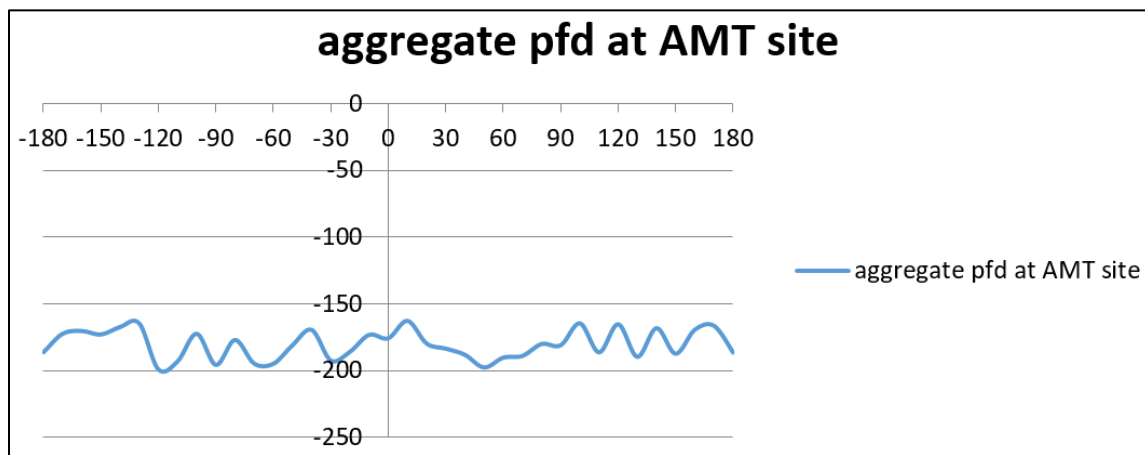

Figure F-16. Aggregate Interference as a Function of AMT Antenna Pointing Angle

6. The above approach is summarized quantitatively in the equations below, which elaborate on those presented earlier, and are re-stated here for the convenience of the reader.

- The value of wavelength that is part of the expression for the effective area of the AMT ground station receive antenna is grouped with the  $1/4\pi r^2$  spreading term, which is then redefined as path loss. This regrouping then permits the spreading term to be replaced with a single term that includes the effects of spreading, terrain and clutter loss, Fresnel zone impingement, and ground reflection. The numerical computation of values for this composite path loss value is independent of the use of Rec M.1459.
- The conversion of PFD values to received power and vice versa involves the scaling term  $4\pi/\lambda^2$ . It is important to account for the presence, or absence, of this term in the equations presented below, so as to not inadvertently delete it or count it twice. This is why the equations below err on the side of redundancy; it is easier to ignore an unneeded equation than to re-derive it.

With this as a reference, the following evolution of equations should prove useful.

1. Start with the free-space Friis equation.  $A_{eff}$  is the effective area of the AMT ground station receive antenna:

$$P_{rec} = EIRP_{xmt} \times \frac{1}{4\pi r^2} \times A_{eff} \quad F-16$$

2. Add antenna gains, the definition of antenna effective area, and the definition of PFD to arrive at:

$$P_{rec} = P_{xmt} G_{xmt} \times \frac{1}{4\pi r^2} \times \frac{\lambda^2 G_{rec}}{4\pi} = pfd_{rec} \times A_{eff} = pfd_{rec} \times \frac{\lambda^2 G_{rec}}{4\pi} \quad F-17$$

3. Move  $\lambda^2/4\pi$  from effective area term and group with the  $\frac{1}{4\pi r^2}$  term per the traditional mathematical definition of path loss. Terrain, ground reflection, clutter, and Fresnel zone effects can now be included in the numerical value used for path loss in subsequent computations:

$$P_{rec} = P_{xmt} G_{xmt} \times \frac{\lambda^2}{4\pi r^2} \times \frac{G_{rec}}{4\pi} = pfd_{rec} \times A_{eff} = pfd_{rec} \times \frac{\lambda^2 G_{rec}}{4\pi} \quad F-18$$

$$pfd_{rec} \times \frac{\lambda^2 G_{rec}}{4\pi} = P_{xmt} G_{xmt} \times \frac{\lambda^2}{(4\pi)^2 r^2} \times \frac{G_{rec}}{1} = P_{xmt} G_{xmt} \times (Path\_Loss) \times \frac{G_{rec}}{1} \quad F-19$$

4. The gain of the AMT ground station receive antenna,  $G_{rec}$ , disappears from the equations when computation of the PFD level at the AMT ground station receiver is the desired result:

$$P_{rec} = pfd_{rec} \times \frac{\lambda^2 G_{rec}}{4\pi} = P_{xmt} G_{xmt} \times (Path\_Loss) \times \frac{G_{rec}}{1} \quad F-20$$

$$P_{rec} = pfd_{rec} \times \frac{\lambda^2 G_{rec}}{4\pi} = P_{xmt} G_{xmt} \times (Path\_Loss) \times \frac{G_{rec}}{1} \quad F-21$$

5. Use the appropriate eNodeB antenna gains described in step 4 to compute  $P_{xmt} G_{xmt}$ . Use the speed of light to compute, for this example, the wavelength  $\lambda$  corresponding to a frequency of 1500 MHz. Scale the EIRP values to the 4-kHz reference bandwidth of the Rec M.1459 PFD protection level. This yields the interference from a single handset as a PFD level measured at the location of the AMT ground station antenna. This value can be compared directly with the protection level from Rec M.1459.

$$pfd_{rec\ in\ 4\ kHz} = (Interference\ in\ Watts\ per\ MHz) \times G_{xmt} \times (Path\_Loss) \times \frac{4\pi}{\lambda^2} \times \frac{4000\ Hz}{1\ MHz} \quad F-22$$

$$\lambda = \frac{3 \times 10^8}{1500 \times 10^6} = 0.20\ meter \quad F-23$$

$$= Interference \times G_{xmt} \times (Path\_Loss) \times \frac{4\pi}{(0.20)^2} \times \frac{4000\ Hz}{1\ MHz}$$

6. Now that the relationships between interference power, path loss, PFD, and  $P_{rec}$  are defined, the aggregation process described earlier can be implemented. The important point is that the PFD values due to each sector of each eNodeB, as measured at an AMT ground station location, are grouped within an angle of arrival wedge, then multiplied by the appropriate value of AMT composite antenna pattern for each angle of arrival value. The total interference from all directions for each possible AMT pointing angle is computed, then changed back into an aggregate value of PFD by the conversion factor  $4\pi/\lambda^2$  to arrive at a single value of aggregate



PFD for each of the 720 possible AMT antenna pointing angles. Each entry in this table of values is then compared with the protection limit from Rec M. 1459.

7. Finally, note that interference to an AMT signal is typically averaged over the bandwidth of the affected AMT channel(s), as described previously. This averaging is accomplished in the same manner that would apply to a traditional I/N analysis. The 4-kHz reference bandwidth in Rec M.1459 must be scaled to correspond to AMT channel bandwidths of 1 – 20 MHz, with 5 MHz being a common value for use in analysis.

**Example 10.** Additional considerations for the modeling of interfering systems

It is important to include effects such as network load factors, transmitters that emit intermittently, and the use of dynamic power control. Note that there are no similar effects related to the performance of AMT operations that need be considered, as these are already captured in Rec M.1459. Annex 2 of Rec M.1459 accounts for signal fades, for the requirement of a minimum value of telemetry link availability, and for the constantly changing location of test aircraft in the sky with respect to both satellite and terrestrial interference sources.

Consider Example 9, coordination of an AMT ground station with emissions from a large network of cellular towers. The cellular industry has noted repeatedly that its networks seldom operate at full load factor. This means that, averaged over several weeks, an individual cellular tower is transmitting only about 60% of the time. Cellular proponents thus advocate a decrease in the computed value of aggregate interference used in analysis by 40%.

The decrease in cellular tower activity at off-peak times corresponds with time slots where flight test activities are also at a minimum (e.g., at night). Furthermore, the time scales over which base station load factors are averaged (weeks) have no correlation with the time duration of interference causing an AMT link to fail (fractions of a second). Short-term interference can cause loss of antenna tracking, which can be difficult to re-establish without the need to re-fly test points.

The point is that when the probability of interference depends on time, it is necessary to use the same time scales for analyzing both the interfering and the victim systems. In the case of AMT operations, this means that all computations need to be performed for the time scale that corresponds to the interval of time that it takes an interfering signal to cause loss of AMT telemetry link bit synchronization. As stated in the previous paragraph, this is not weeks or days, but fractions of a second. In any case, loss of even small amounts of data can make it necessary to re-fly part, or even all, of the maneuvers included in a particular test flight.

Coordination of AMT ground stations with emissions from cellular handsets introduces similar issues. These handsets use dynamic power control, in which a cellular tower measures the received signal from a handset in real time and sends instructions to the handset to adjust its transmit power.

In addition, LTE and WiMAX (i.e., 802.16) systems operate by using orthogonal frequency division multiplexing, in which data are coded among several adjacent frequency subcarriers spread across the 10 – 20 MHz LTE bands.<sup>79</sup> The power amplitudes of each subcarrier vary with time, yielding variations characterized by what is called the peak-to-average-power-ratio (PAPR). For LTE, the PAPR is about 6 dB, with variations occurring on the

---

<sup>79</sup> WiMAX will be used for the AeroMACS system at 5091- 5150 MHz, co-channel with AMT.

order of milliseconds. For WiMAX, the PAPR is as high as 13 dB. The statistical distribution as a function of time for each system is characterized by a complementary cumulative distribution function.

It remains an open question whether PAPR fluctuations, which include reductions as well as surges in transmit power, are a concern.

**Example 11.** Special considerations regarding AMT antennas

The use of a composite antenna in Rec M. 1459 is referenced multiple times in this appendix. In the recommendation, however, the development of the composite antenna pattern is described in the body of Annex A only for the case of lower L-band, which has a pattern that is based on the NTIA Statgain antenna model of parabolic dish antennas (Wang and Keech, 2012), and is derived numerically for antennas having diameters of 10 meters and 2.44 meters. The composite pattern is derived by comparing the 10-meter and 2.44-meter patterns side-by-side and choosing the value of gain that is higher for a given off-axis pointing angle.

Although not described explicitly in the recommendation, the antenna pattern was modified for the purpose of computing the protection criteria for upper S-band that are also published in the recommendation. The L- and S-band frequencies are sufficiently close in value that the same composite pattern can be used for both bands for purposes of computing aggregate interference. This is a result of certain complex convolution computations described in the methodology provided by the recommendation; however, this simplification does not apply as telemetry systems are deployed at C-band and higher frequencies.

To address the computation of the protection criteria for upper L, lower S, and lower, middle, and upper C-bands, new composite antenna patterns were computed using the NTIA Statgain antenna pattern formulas given below.

Although the antenna patterns are not needed again for purposes of determining the protection criteria, they are needed when computing aggregation from large numbers of terrestrial interferers. For this purpose, the process of computing composite antenna patterns is straightforward, and is described below.

With respect to the computation of composite antenna patterns, the gain of both a 10-meter and 2.44-meter diameter dish were computed for each band using the Statgain formulas with the gain parameter  $G_{max}$  for each dish computed using the formula

$$G_{max} = 0.55 \times \left( \pi D / \lambda \right)^2 \quad \text{F-24}$$

where 0.55 represents the nominal efficiency of the dish antennas.

Then, using the equations below, patterns were computed for both the 10-meter and 2.44-meter antennas for each value of signal wavelength  $\lambda$ . Using a simple spreadsheet, the gains of the two antennas as a function of off-axis angle for each value of  $\lambda$  were compared. The higher gain value of the two antennas was chosen as the value for that angle for the corresponding composite antenna. Although this is a slight simplification of the side-lobe averaging technique used in the recommendation, the impact on the numerical values of the protection criteria was found to be negligible. This means that for computational purposes, the Statgain antenna patterns can be used for C and higher bands without modification.

In addition to the Statgain formulas, which provide an envelope function for the maximum values of the gain pattern, the more general pattern equations are also provided. These are difficult to find in textbooks, but are often useful.

The Statgain radiation patterns,  $G(\phi)$ , as a function of the angle from the main-beam axis,  $\phi$ , are shown in [Table F-1](#) (Wang and Keech 2012) and the Statgain envelope pattern is presented in [Figure F-17](#) (Wang and Keech 2012). The more general pattern equations, published as part of the Satellite Toolkit software, are provided afterwards.

<b>Table F-1. Statgain Formulas</b>		
<b>Category</b>	<b>Gain(<math>\phi</math>) (dBi)</b>	<b>Angular Range (deg.)</b>
$G_{\max} \geq 48$ dBi	$G_{\max} - 4 \times 10^{-4} (10^{G_{\max}/10}) \phi^2$	$0 \leq \phi \leq \phi_m$
	$0.75 \times G_{\max} - 7$	$\phi_m < \phi \leq \phi_{r1}$
	$29 - 25 \times \log(\phi)$	$\phi_{r1} < \phi \leq \phi_{b1}$
	-13	$\phi_{b1} < \phi \leq 180^\circ$
$22 \leq G_{\max}(\text{dBi}) < 48$	$G_{\max} - 4 \times 10^{-4} (10^{G_{\max}/10}) \phi^2$	$0 \leq \phi \leq \phi_m$
	$0.75 \times G_{\max} - 7$	$\phi_m < \phi \leq \phi_{r2}$
	$53 - (G_{\max}/2) - 25 \times \log(\phi)$	$\phi_{r2} < \phi \leq \phi_{b2}$
	$11 - G_{\max}/2$	$\phi_{b1} < \phi \leq 180^\circ$
$10 \leq G_{\max}(\text{dBi}) < 22$	$G_{\max} - 4 \times 10^{-4} (10^{G_{\max}/10}) \phi^2$	$0 \leq \phi \leq \phi_m$
	$0.75 \times G_{\max} - 7$	$\phi_m < \phi \leq \phi_{r3}$
	$53 - (G_{\max}/2) - 25 \times \log(\phi)$	$\phi_{r3} < \phi \leq \phi_{b3}$
	0	$\phi_{b3} < \phi \leq 180^\circ$
All angles are in degrees. $\phi_m = 50(0.25G_{\max} + 7)^{0.5}/(10^{G_{\max}/20})$ $\phi_{r1} = 27.466 \times 10^{-0.03G_{\max}/10}$ $\phi_{r1} = \phi_{r1} = 250/(10^{G_{\max}/20})$ $\phi_{b1} = \phi_{b2} = 48$ $\phi_{b3} = 131.8257 \times 10^{-G_{\max}/50}$		

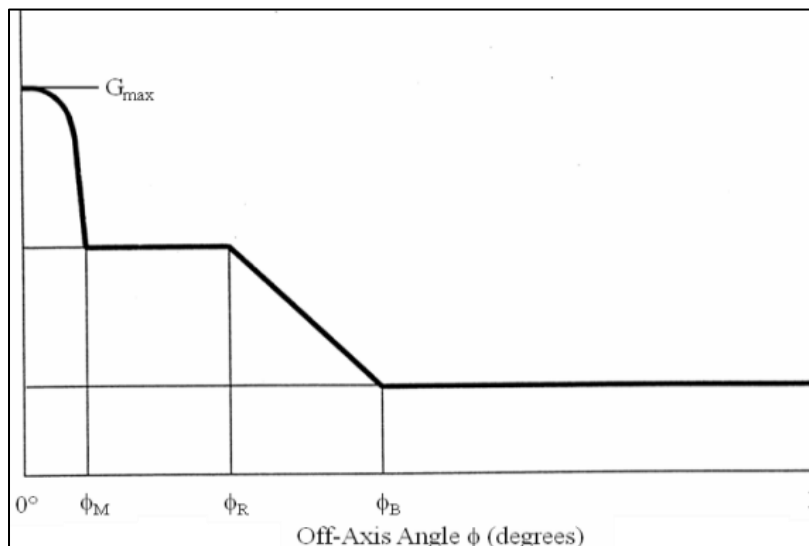

Figure F-17. Statgain Pattern

Note that the Statgain patterns provide an upper envelope of the antenna pattern. The more-generalized parabolic dish equations are available as part of the Analytical Graphics (AGI) Satellite Toolkit software tool.<sup>80</sup> These equations provide details about the peaks and nulls of the antenna side-lobes as opposed to providing an envelope of the pattern, and are given below.

The parabolic antenna parameters are:

$d$  = diameter of the parabolic dish

$\lambda$  = wavelength

The gain of a parabolic antenna is modeled by the equations [F-25a](#), [F-25b](#), and [F-25c](#):

$$x = \frac{\pi d}{\lambda} \sin \phi \quad \text{F-25a}$$

$$G_{Max} = \rho_e \left( \pi \frac{d}{\lambda} \right) \quad \text{F-25b} \quad \text{F-25}$$

$$G(\phi) = G_{Max} \left( \frac{2J_1(x)}{x} \right) \quad \text{F-25c}$$

where  $\rho_e$  = the antenna efficiency,  $\phi$  = angle off boresight, and  $J_1$  = first-order Bessel function. This model is for a uniformly illuminated circular aperture dish.

On a final note, the question has been posed of how to compute protection criteria for antennas whose diameter falls outside the range of 2.44 – 10 meters. The simple and reasonable approach is to recognize that both the gain and beamwidth of a parabolic-dish antenna are related to the parameter  $D/\lambda$ . For the case of an antenna that is 13 meters in diameter but operating at upper L-band (for example),  $D/\lambda$  is about 75. This is comparable to a 10-meter antenna operating at a wavelength of 0.133 meters. Since the protection criteria for upper S-band correspond to a wavelength of 0.128 meters, it seems appropriate to use the protection criteria for upper S-band as the values for a 13-meter diameter antenna operating at upper L-band.

---

<sup>80</sup> Maral, G., and M. Bousquet. *Satellite Communications Systems: Systems, Techniques and Technology*. 2<sup>nd</sup> ed. Chichester: Wiley (1993), sec. 2.1.3; Gagliardi, Robert M. *Satellite Communications*. 2<sup>nd</sup> ed., New York: Van Nostrand Reinhold (1991), sec. 3.2.

## APPENDIX 2-G

**Standards for Data Quality Metrics and Data Quality Encapsulation****G.1. Purpose**

This appendix provides a standard for a DQM, determined in the telemetry receiver demodulator, and a standard for DQE allowing for transport of the received telemetry data and associated DQM to a distant best source selector or similar device. The DQE standard enables telemetry receivers to generate a serial data stream that includes a standardized measurement of the real-time probability of error for a grouping of bits.

**G.2. Scope**

The DQM standard describes how to map the estimated BEP of the received telemetry data to a 16-bit word. The DQM standard does not define how the telemetry receiver performs BEP estimates. The DQE standard describes how to format received telemetry data with the associated DQM for transport.

**G.3. Data Quality Metric**

The general case of DQM is calculated using:

$$DQM = -\log_{10}(LR)$$

where:

$$LR = \frac{BEP}{(1 - BEP)}$$

is the likelihood ratio. For mapping this value into an  $n$ -bit word with a lowest BEP exponent equal to  $k$ , the equation becomes:

$$DQM = \begin{cases} X, & X \leq 2^n - 1 \\ 2^n - 1, & \text{otherwise} \end{cases} \quad X = \left\lfloor \frac{-\log_{10}(LR)}{k} \times 2^n \right\rfloor$$

Where the notation  $\lfloor z \rfloor$  denotes the greatest integer less than or equal to  $z$ .

<b>NOTE</b> 	For this standard, $k=12$ and $n=16$ .
--	--

- The measurement value corresponds to the average quality of the data bits in the payload.
- The DQM value is associated with the payload bits in the current block frame. [Table G-1](#) defines LR and DQM for various values of BEP.

<b>Table G-1. BEP Versus DQM</b>		
<b>BEP</b>	<b>LR</b>	<b>DQM</b>
0.5	1.00	0
1e-01	1.11111e-01	5211
1e-02	1.01010e-02	10898

1e-03	1.00100e-03	16381
1e-04	1.00010e-04	21845
1e-05	1.00001e-05	27306
1e-06	1.00000e-06	32767
1e-07	1.00000e-07	38229
1e-08	1.00000e-08	43690
1e-09	1.00000e-09	49151
1e-10	1.00000e-10	54613
1e-11	1.00000e-11	60074
1e-12	1.00000e-12	65535

**NOTE**  It is not required that BEP be estimated to the 1.0e-12 level. Estimates to a lesser level are acceptable; however, the format above shall be followed in all cases. For example, if estimating BEP to the 1.0e-8 level, the applicable range of DQM values shall be 0 to 43690.

**G.4. Data Quality Encapsulation Protocol**

The block format is equivalent to a fixed-length PCM frame. Transmission of payload data shall be first in - first out. Transmission of other fields shall be most significant bit first.

16 Bits	12 Bits	4 Bits	16 Bits	1024 – 16384 Bits
SW	RSV	VER	DQM	PAYLOAD

- a. SW = Sync Word. The sync word is a fixed value of 0xFAC4.
- b. RSV = Reserved. Reserved for future use. These bits shall be set to zero (0) until used.
- c. VER = IRIG 106 Version number. Version number shall start with Version 0 (0000) for IRIG 106-17 and be incremented when revisions to this appendix are made.

Version	Release
0 (0000)	106-17
1 (0001)	106-22
2 (0010)	

- d. DQM = Data Quality Metric. This field will contain the DQM value as defined in Section [G.3](#)
- e. PAYLOAD = Telemetry data payload to which the DQM value applies. The DQM and the data payload are contained in the same block. The minimum payload size shall be 1024 bits and the maximum size shall be 16,384 bits. Payload size can be any multiple of 32 bits between the minimum size and maximum size. In the absence of any other determining factor the default payload size is 4096 bits.

When block coding is applied to the telemetry link the default payload size is set by the information block size. If multiple block codes are applied the default payload size is set by the information block size of the outer code. The default payload sizes for each are as follows.

STC (see [Appendix 2-E](#)): 3200 bits

LDPC (see [Appendix 2-D](#)) or STC-LDPC ( $k=1024$ ): 1024 bits

LDPC or STC-LDPC ( $k=4096$ ): 4096 bits

Any bit manipulation should be done prior to placing the data into the PAYLOAD field without affecting the 48 bits of header encapsulation. Examples of bit manipulation are inversion and de-randomization.

This page intentionally left blank.



## APPENDIX 2-H

**Dynamic Multipath Channel Model for Aeronautical Mobile Telemetry****H.1. Preliminaries**

Theoretical considerations for aeronautical multipath channels were published by Bello.<sup>81</sup> The aeronautical channel comprised three terms, an LOS term, a specular reflection term, and a diffuse reflection term. The application of this three-ray model to aeronautical mobile telemetry was confirmed by channel sounding experiments performed by Rice et al.<sup>82</sup>

The impulse response for a static three-ray multipath channel is

$$h(t) = \delta(t) + \Gamma_1 e^{-j2\pi f_c \tau_1} \delta(t - \tau_1) + \Gamma_2 e^{-j2\pi f_c \tau_2} \delta(t - \tau_2) \quad \text{H-1}$$

Notes:

- Just as signals have an in-phase/quadrature-component (I/Q) representation, a channel also has an I/Q representation. The I/Q representations of signals and channels are usually represented by complex-valued waveforms where the real part of the waveform defines the I component and the imaginary part defines the Q component. The impulse response (Equation [H-1](#)) is the I/Q representation of the multipath channel.
- The first term on the right-hand side of Equation [H-1](#) represents the LOS propagation. No propagation losses (such as “ $1/R^2$ ” spreading losses and atmospheric attenuation) or gains (such as transmit and receive antenna gains) are included. The LOS component has unity gain and zero delay. In this sense, the impulse response (Equation [H-1](#)) is normalized to the LOS component. The losses and gains show up as a bulk attenuation factor applied to all three terms on the right-hand side of Equation [H-1](#). The bulk attenuation impacts the received signal-to-noise ratio, not the properties of the multipath propagation.
- The second term on the right-hand side of Equation [H-1](#) is the specular reflection. The parameters that define the specular reflection are as follows.

$\Gamma_1$	the complex-valued reflection coefficient at the reflection point. The value of the reflection coefficient is defined by the carrier frequency, the electrical properties of the reflection medium, and the incidence angle (Rice et al).
$f_c$	the carrier frequency in Hz.
$\tau_1$	the relative delay between the LOS component and the specularly reflected component. The delay is determined by the geometry defined by the position of the airborne transmitter, the position of the ground-based receiver, and location of the reflection point. In almost all scenarios, the reflection is a ground- or sea-based reflection.

Using  $\Gamma_1 = |\Gamma_1|e^{j\gamma_1}$  to represent the reflection coefficient, the specular reflection experiences an attenuation equal to  $|\Gamma_1| < 1$  and a phase shift  $\gamma_1$  relative to the LOS component. The term  $2\pi f_c \tau_1$  is an additional phase shift due to the longer propagation

<sup>81</sup> Phillip Bello. “Aeronautical channel characterization.” *IEEE Transactions on Communications*, vol. 21, no. 5, pp. 548–563, May 1973.

<sup>82</sup> Rice, M., A. Davis, and C. Bettweiser. “Wideband channel model for aeronautical telemetry.” *IEEE Transactions on Aerospace and Electronic Systems*, vol. 40, no. 1, pp. 57–69, January 2004.

path from transmitter to receiver via the specular reflection point. The specular reflection is determined completely by the geometry.

- The third term on the right-hand side of Equation [H-1](#) is called the diffuse reflection. The parameters that define the diffuse reflection are as follows.

$\Gamma_2$	the complex-valued reflection coefficient at the reflection points. The value of the reflection coefficient is defined by the carrier frequency, the electrical properties of the reflection medium, and the incidence angles (Rice et al).
$f_c$	the carrier frequency in Hz.
$\tau_2$	the relative delay between the LOS component and the diffusely reflected component. The delay is determined by the geometry defined by the position of the airborne transmitter, the position of the ground-based receiver, and location of the reflection points.

This term is called diffuse because it is the result of many weak reflections with statistically independent amplitudes, phases, and delays. Consequently, the reflection coefficient  $\Gamma_2$  and delay  $\tau_2$  are less well-defined. This term is the result of the interaction with non-smooth reflectors some distance away from the specular reflection point, such as mountains and hills (in the case of a land-based range) or large sea swells (in the case of a sea-based range). Theoretically the diffuse reflection is determined completely from the geometry defined by the position of the airborne transmitter, the position of the ground-based receiver, and the positions of all non-specular reflectors. Because detailed terrain or sea-state information is rarely known at sub-wavelength resolution, a deterministic evaluation of this parameter is not practical. For this reason, statistical characterizations of  $\Gamma_2$  and  $\tau_2$  are used.

- If  $s(t)$  represents the I/Q representation of the transmitted signal, then the I/Q representation of the received signal is given by the convolution of  $s(t)$  with Equation [H-1](#):

$$r(t) = s(t) + \Gamma_1 e^{-j2\pi f_c \tau_1} s(t - \tau_1) + \Gamma_2 e^{-j2\pi f_c \tau_2} s(t - \tau_2) \quad \text{H-2}$$

Note here that the received signal comprises three copies of the transmitted signal. The first copy of the signal is the signal itself and represents LOS propagation. The second and third copies are delayed, phase-shifted, and attenuated versions of the transmitted signal.

## H.2. The Dynamic Multipath Channel

Multipath propagation is a spatial phenomenon in the sense that the parameters that define multipath propagation are a function of the geometry defined by the positions of the airborne transmitter, the ground-based receiver, and the reflectors. As the airborne transmitter moves, the relative positions of receiver and reflectors change. Because the airborne position changes with respect to time, the geometry defining multipath propagation changes with respect to time. Consequently, the four constants  $\Gamma_1$ ,  $\Gamma_2$ ,  $\tau_1$ , and  $\tau_2$  are replaced by functions of time:  $\Gamma_1(t)$ ,  $\Gamma_2(t)$ ,  $\tau_1(t)$ , and  $\tau_2(t)$ . The impulse response (Equation [H-1](#)) is modified to produce the time-varying impulse response

$$h(t) = \delta(t) + \Gamma_1(t)e^{-j2\pi f_c \tau_1(t)}\delta(t - \tau_1(t)) + \Gamma_2(t)e^{-j2\pi f_2 \tau_2(t)}\delta(t - \tau_2(t)) \quad \text{H-3}$$

Notes:

- The first term on the right-hand side of Equation [H-3](#) represents the LOS propagation component. Its properties are same as the LOS component in Equation [H-1](#).
- The second term on the right-hand side of Equation [H-3](#) is the specular reflection. The parameters that define the specular reflection are described in the previous section. The theoretical analysis in Rice and Ebert<sup>83</sup> shows that  $\Gamma_1(t)$  changes so slowly that it may be considered constant for a multipath event. Consequently, changes in the specular reflection are due entirely to changes in  $\tau_1(t)$ . It is shown in Rice and Ebert that the specular reflection term may be expressed as

$$\Gamma_1(t)e^{-j2\pi f_c \tau_1(t)}\delta(t - \tau_1(t)) \approx |\Gamma_1|e^{-j(2\pi f_d t + \theta_1)}\delta(t - \tau_1(t)) \quad \text{H-4}$$

where  $f_d$  is the Doppler frequency and  $\theta_1$  is a constant. Computation of the Doppler frequency  $f_d$  is discussed in Rice and Ebert. The Doppler frequency produces a time variation in the frequency of the spectral null caused by the specular reflection. The time variation is linear in the time variable giving rise to the often-observed “sweeping” of the spectral null across the signal spectrum during a test flight.

- The third term on the right-hand side of Equation [H-3](#) is called the diffuse reflection. The parameters that define the diffuse reflection are described in the previous section. Statistical characterizations of  $\Gamma_2(t)$  and  $\tau_2(t)$  were investigated in Bello where it was shown that  $|\Gamma_2(t)|$  is a Rayleigh random process with a Gaussian power spectral density given by

$$S_2(f) = \frac{\sqrt{2}}{B_{\text{rms}}\sqrt{\pi}} \exp\left\{-2\left(\frac{f}{B_{\text{rms}}}\right)^2\right\} \quad \text{H-5}$$

where  $B_{\text{rms}}$  is the rms Doppler spread. For the purposes of this channel model, the delay  $\tau_2(t)$  is set equal to the average delay  $\overline{\tau_2(t)}$  of the diffuse component.

### H.3. Channel Emulator Settings

The impulse response described in the previous section was instantiated on a Spirent SR5500 Wireless Channel Emulator. This example is broadly applicable to a variety of channel emulators because most channel emulators have similar user interfaces. A channel emulator defines a number of propagation paths through which the input signal passes. The outputs of the propagation paths are combined to create channel emulator output. Here, three paths are used to represent propagation through a channel defined by the impulse response (Equation [H-3](#)) with parameters for the reflection coefficients, delays, and Doppler frequencies obtained from Rice et al and corresponding to a flight path along Cords Road at Edwards AFB at an altitude of 5,000 feet above mean sea level and velocity of Mach 1:

---

<sup>83</sup> Rice, M. and J. Ebert. “Derivation and analysis of the IRIG-106 dynamic multipath channel model,” in *Proceedings of the International Telemetry Conference*, Las Vegas, NV, 25-28 October 2021 (forthcoming).

$$|\Gamma_1| = 0.944, |\Gamma_2| = 0.1, \tau_1(t) = 10 \text{ ns}, \overline{\tau_2(t)} = 155 \text{ ns}, \text{ and } f_d = 3 \times 10^{-11} f_c \text{ Hz}$$

In the Spirent 5500, “Path 1” is the LOS component, “Path 2” is the specular reflection, and “Path 3” is the diffuse reflection. The parameters for the three paths in the channel emulator are shown in [Table H-1](#), [Table H-2](#), and [Table H-3](#).

Notes:

- The power spectral density for the diffuse component should be the Gaussian power spectral density given by Equation [H-5](#) and plotted in [Figure H-1](#). Unfortunately, the Spirent SR5500 does not have the option for producing a Gaussian power spectral density. The available options for the Spirent SR5500 are shown in [Figure H-2](#). Of the available options, the “Rounded 12 dB” is closest to the Gaussian power spectral density. Consequently, the fading spectrum shape for the Path 3 is set to “Rounded 12 dB” in [Table H-1](#), [Table H-2](#), and [Table H-3](#).

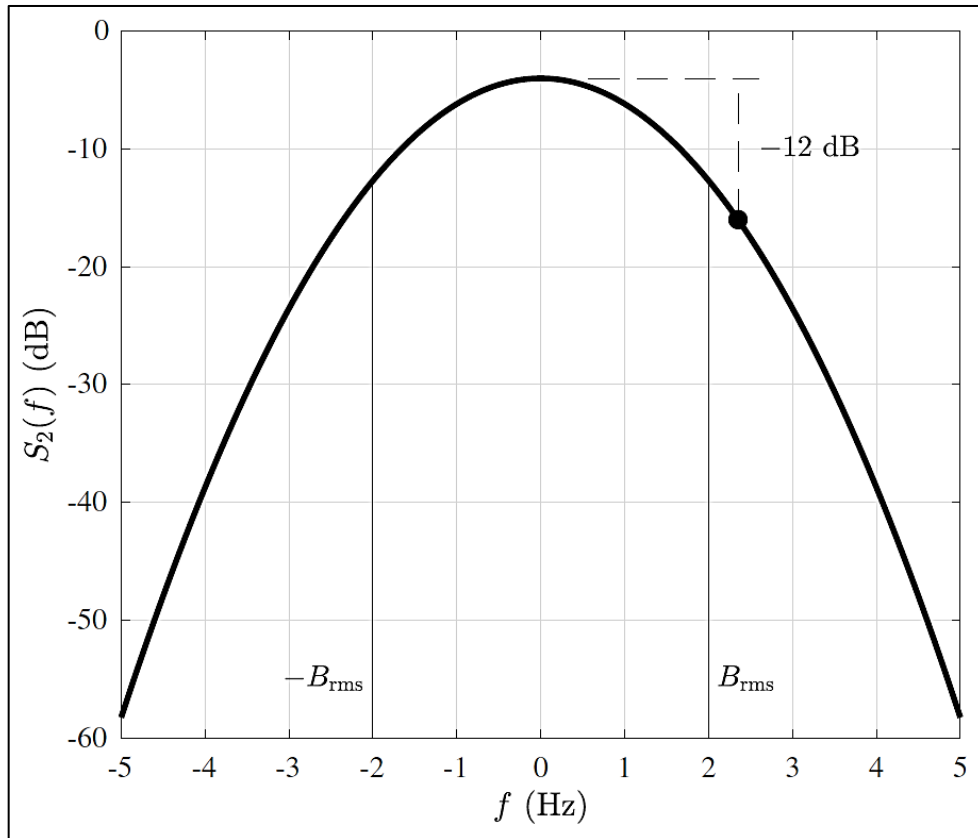

Figure H-1. The Gaussian Power Spectral Density  $S_2(f)$  given by Eq. [H-5](#) for  $B_{rms}=2$  Hz

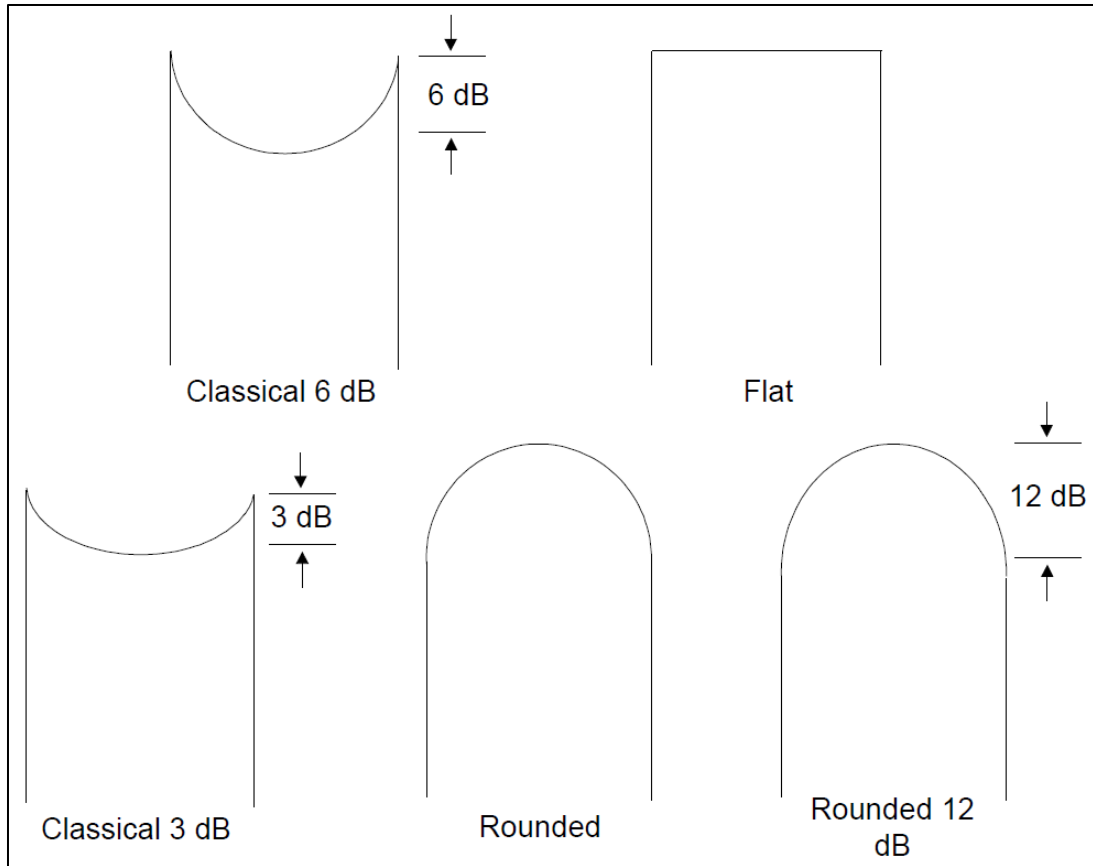

Figure H-2. The Options for the Power Spectral Density of the Diffuse Component in the Spirent SR5500 Wireless Channel Emulator (Spirent, p. 153)

- The Spirent SR5500 does not operate at C band because the operational range is 400 to 2700 MHz.<sup>84</sup> C-band testing can be accomplished using a transmitter operating a C-band connected to a C-band downconverter (see Subsection 2.4.7) whose output is connected to the channel emulator. The transmitter carrier frequency should be chosen to ensure the output of the C-band downconverter is greater than 400 MHz. The carrier frequency setting on the channel emulator should be the output frequency of the C-band downconverter.
- These channel settings best model the Cords Road scenario described in Rice et al and Rice and Ebert where the velocity of the airborne transmitter is Mach 1. For other scenarios, the reflection coefficients and channel delays may be different. The differences will depend largely on the geometry defined by the position of the airborne transmitter, the position ground-based receiving station, and the positions of the reflecting media (Rice and Ebert).

<sup>84</sup> Spirent. *SR5500 Wireless Channel Emulator User Manual*. Copyright 2011. 71-003547, Version A7. May be superseded by update. Retrieved 17 May 2021. Available at [https://support-kb.spirent.com/resources/sites/SPIRENT/content/live/DOCUMENTATION/10000/DOC10397/en\\_US/UM\\_SR5500\\_v3\\_50\\_A7.pdf](https://support-kb.spirent.com/resources/sites/SPIRENT/content/live/DOCUMENTATION/10000/DOC10397/en_US/UM_SR5500_v3_50_A7.pdf).

- For different velocities, the Path 2 frequency shift and Path 3 fading Doppler scale proportionally.
- On most test ranges, multipath propagation is an intermittent phenomenon. The settings here do not capture the “birth” and “death” of multipath events, but instead the dynamics of multipath propagation during a multipath event.

**Table H-1. Spirent SR5500 Wireless Channel Emulator Settings for Three Paths that Define the Dynamic Multipath Channel for Aeroautical Mobile Telemetry in L-Band**

Path 1		Path 2		Path 3	
Modulation	Static	Modulation	Static	Modulation	Rayleigh
Fading Doppler	N/A	Fading Doppler	N/A	Fading Doppler	1.32 Hz
Phase shift	0°	Phase shift	0°	Phase shift	0°
Frequency shift mode	Fixed	Frequency shift mode	Fixed	Frequency shift mode	Fixed
Frequency shift	0 Hz	Frequency shift	0.05 Hz	Frequency shift	0 Hz
Fading spectrum shape	N/A	Fading spectrum shape	N/A	Fading spectrum shape	Rounded 12 dB
Delay mode	Fixed	Delay mode	Fixed	Delay mode	Fixed
Delay value	0 $\mu$ s	Delay value	0.01 $\mu$ s	Delay value	0.155 $\mu$ s
Relative path loss	0 dB	Relative path loss	0.5 dB	Relative path loss	20 dB
Log-normal enable	No	Log-normal enable	No	Log-normal enable	No

**Table H-2. Spirent SR5500 Wireless Channel Emulator Settings for Three Paths that Define the Dynamic Multipath Channel for Aeroautical Mobile Telemetry in S-Band**

Path 1		Path 2		Path 3	
Modulation	Static	Modulation	Static	Modulation	Rayleigh
Fading Doppler	N/A	Fading Doppler	N/A	Fading Doppler	2.0 Hz
Phase shift	0°	Phase shift	0°	Phase shift	0°
Frequency shift mode	Fixed	Frequency shift mode	Fixed	Frequency shift mode	Fixed
Frequency shift	0 Hz	Frequency shift	0.07 Hz	Frequency shift	0 Hz
Fading spectrum shape	N/A	Fading spectrum shape	N/A	Fading spectrum shape	Rounded 12 dB
Delay mode	Fixed	Delay mode	Fixed	Delay mode	Fixed
Delay value	0 $\mu$ s	Delay value	0.01 $\mu$ s	Delay value	0.155 $\mu$ s
Relative path loss	0 dB	Relative path loss	0.5 dB	Relative path loss	20 dB
Log-normal enable	No	Log-normal enable	No	Log-normal enable	No

**Table H-3. Spirent SR5500 Wireless Channel Emulator Settings for Three Paths that Define the Dynamic Multipath Channel for Aeroautical Mobile Telemetry in C-Band**

Path 1		Path 2		Path 3	
Modulation	Static	Modulation	Static	Modulation	Rayleigh
Fading Doppler	N/A	Fading Doppler	N/A	Fading Doppler	4.52 Hz
Phase shift	0°	Phase shift	0°	Phase shift	0°
Frequency shift mode	Fixed	Frequency shift mode	Fixed	Frequency shift mode	Fixed
Frequency shift	0 Hz	Frequency shift	0.15 Hz	Frequency shift	0 Hz
Fading spectrum shape	N/A	Fading spectrum shape	N/A	Fading spectrum shape	Rounded 12 dB
Delay mode	Fixed	Delay mode	Fixed	Delay mode	Fixed
Delay value	0 $\mu$ s	Delay value	0.01 $\mu$ s	Delay value	0.155 $\mu$ s
Relative path loss	0 dB	Relative path loss	0.5 dB	Relative path loss	20 dB
Log-normal enable	No	Log-normal enable	No	Log-normal enable	No



## APPENDIX 2-I

### Citations

- Code of Federal Regulations, Table of Frequency Allocations, title 47, sec. 2.106.
- Code of Federal Regulations, Frequencies, frequency tolerance, and emission limits, title 47, sec. 25.202.
- CommScope. “Calculators and Tools.” Retrieved 17 May 2021.  
<http://www.commscope.com/Resources/Calculators/>.
- Consultative Committee for Space Data Systems. *Low Density Parity Check Codes for Use in Near-Earth and Deep Space Applications*. Standard CCSDS 131.1-O-2-S. September 2007. Rescinded. Retrieved 17 May 2021. Available at  
<https://public.ccsds.org/Pubs/131x1o2e2s.pdf>.
- D.G. Jablonski. “Demonstration of Closed Loop Steering of Antenna Patterns for Mitigating Antenna-to-Antenna Interference in Two-Antenna Telemetry Installations on Military Aircraft,” Instrumentation Test Technical Symposium, New Orleans, LA, 25 August 2004.
- Department of Defense. “Requirements for the Control of Electromagnetic Interference Characteristics of Subsystems and Equipment.” MIL-STD-461-G. 11 December 2015. May be superseded by update. Retrieved 17 May 2021. Available at  
[https://quicksearch.dla.mil/qsDocDetails.aspx?ident\\_number=35789](https://quicksearch.dla.mil/qsDocDetails.aspx?ident_number=35789).
- E. L. Law. “RF Spectral Characteristics of Random PCM/FM and PSK Signals.” International Telemetry Conference Proceedings, pp. 71 80, 1991.
- E. Perrins. “FEC Systems for Aeronautical Telemetry”. *IEEE Transactions on Aerospace and Electronic Systems*, vol. 49, no. 4, pp. 2340-2352, October 2013.
- Federal Communications Commission. “Amendment of Part 27 of the Commission’s Rules to Govern the Operations of Wireless Communications Services in the 2.3 GHz Band.” WT Docket No. 07-293. In *Order on Reconsideration*. FCC 12-130. 17 October 2012. Retrieved 17 May 2021. Available at  
[https://apps.fcc.gov/edocs\\_public/attachmatch/FCC-12-130A1.pdf](https://apps.fcc.gov/edocs_public/attachmatch/FCC-12-130A1.pdf).
- Hufford, G. A. and F. K. Steele. “Tabulations of Propagation Data over Irregular Terrain in the 75- To 8400-Mhz Frequency Range - Part V: Virginia.” NTIA Publication 91-282, December 1991. Retrieved 17 May 2021. Available at  
<https://www.its.blrdoc.gov/publications/download/91-282.pdf>.
- I. Korn. *Digital Communications*. New York; Van Nostrand, 1985.

- International Telecommunications Union. “Compatibility between the Earth exploration-satellite service (passive) and relevant active services” *Final Acts WRC-15 – World Radiocommunication Conference*. Geneva, 2015. pp. 399-403.
- . “Method for point-to-area predictions for terrestrial services in the frequency range 30 MHz to 3 000 MHz.” ITU-R Recommendation P.1546-6. August 2019. May be superseded by update. Retrieved 17 May 2021. Available at <https://www.itu.int/rec/R-REC-P.1546/en>.
- . “Prediction procedure for the evaluation of interference between stations on the surface of the Earth at frequencies above about 0.1 GHz.” ITU-R Recommendation P.452-16. July 2015. May be superseded by update. Retrieved 17 May 2021. Available at <https://www.itu.int/rec/R-REC-P.452/en>.
- . “Propagation curves for aeronautical mobile and radionavigation services using the VHF, UHF, and SHF bands.” ITU-R Recommendation P.528-4. August 2019. May be superseded by update. Retrieved 17 May 2021. Available at <https://www.itu.int/rec/R-REC-P.528/en>.
- . “Protection criteria for telemetry systems in the aeronautical mobile service...” ITU-R Recommendation M.1459. May 2000. May be superseded by update. Retrieved 17 May 2021. Available at <https://www.itu.int/rec/R-REC-M.1459-0-200005-I/en>.
- . “Radio Regulations: Articles.” 2012. May be superseded by update. Retrieved 17 May 2021. Available at <http://search.itu.int/history/HistoryDigitalCollectionDocLibrary/1.41.48.en.101.pdf>.
- Jensen, M., M. Rice, and A. Anderson. “Aeronautical Telemetry Using Multiple-Antenna Transmitters.” *IEEE Transactions on Aerospace and Electronic Systems*, vol. 43, no. 1, pp. 262-272, January 2007.
- K. Temple. “Performance Evaluation of Space-Time coding on an Airborne Test Platform.” Paper presented at the 50<sup>th</sup> International Telemetry Conference, San Diego, CA, October 2014.
- Kamilo Feher. *Digital Communications: Satellite/Earth Station Engineering*. Englewood Cliffs: Prentice-Hall, 1983, pp. 168-170.
- M. G. Pelchat. “The Autocorrelation Function and Power Spectrum of PCM/FM with Random Binary Modulating Waveforms.” *IEEE Transactions*, Vol. SET 10, No. 1, pp. 39 44, March 1964.
- M. Richharia. *Satellite Communications Systems, Second Edition*. New York; London: McGraw-Hill, 1999, page 37.
- Maral, G., and M. Bousquet. *Satellite Communications Systems: Systems, Techniques and Technology*. 2<sup>nd</sup> ed. Chichester: Wiley (1993), sec. 2.1.3; Gagliardi, Robert M. *Satellite Communications*. 2<sup>nd</sup> ed., New York: Van Nostrand Reinhold (1991), sec. 3.2.

- Mark Geoghegan. "Implementation and Performance Results for Trellis Detection of SOQPSK." Paper presented at the 37th Annual International Telemetry Conference, Las Vegas, NV, October 2001.
- . "Improving the Detection Efficiency of Conventional PCM/FM Telemetry by using a Multi-Symbol Demodulator." *Proceedings of the 2000 International Telemetry Conference*, Volume XXXVI, 675-682, San Diego CA, October 2000.
- . "Optimal Linear Detection of SOQPSK." In *Proceedings of the International Telemetry Conference*, San Diego, CA, October 2002.
- Marvin Simon. "Multiple-Bit Differential Detection of Offset Quadrature Modulations." IPN Progress Report 42-151. 15 November, 2002. Jet Propulsion Laboratory, Pasadena, CA. Retrieved 17 May 2021. Available at [http://ipnpr.jpl.nasa.gov/progress\\_report/42-151/151A.pdf](http://ipnpr.jpl.nasa.gov/progress_report/42-151/151A.pdf).
- Michael Rice. *Digital Communications: A Discrete-Time Approach*. Pearson/Prentice-Hall. Upper Saddle River, NJ, 2009.
- . "Space-Time Coding for Aeronautical Telemetry: Part 1 – System Description," in *Proceedings of the International Telemetry Conference*, Las Vegas, NV, October 2011.
- National Telecommunications and Information Administration. "Manual of Regulations and Procedures for Federal Radio Frequency Management." September 2015. May be superseded by update. Retrieved 17 May 2021. Available at [https://www.ntia.doc.gov/files/ntia/publications/manual\\_sep\\_2015.pdf](https://www.ntia.doc.gov/files/ntia/publications/manual_sep_2015.pdf).
- Osborne, W. P. and M. B. Luntz. "Coherent and Noncoherent Detection of CPFSK," *IEEE Transactions on Communications*, August 1974.
- P. Laurent. "Exact and Approximate Construction of Digital Phase Modulations by Superposition of Amplitude Modulated Pulses (AMP)." *IEEE Transactions on Communications*, vol. 34, no. 2, pp. 150-160, February 1986.
- Perrins, E. and M. Rice. "Reduced-Complexity Approach to Iterative Detection of Coded SOQPSK." *IEEE Transactions on Communications*, vol 55, no. 7, pp 1354-1362, July 2007.
- . "Reduced-complexity Detectors for Multi-h CPM in Aeronautical Telemetry." In *IEEE Transactions on Aerospace and Electronic Systems*, vol. 40, no. 1, pp. 286-300, January 2007.
- . "Unification of Signal Models for SOQPSK." In *Proceedings of the International Telemetry Conference*, Glendale, AZ, 5-8 November 2018.
- Phillip Bello. "Aeronautical channel characterization." *IEEE Transactions on Communications*, vol. 21, no. 5, pp. 548-563, May 1973.

- Phillips, C., D. Sicker, and D. Grunwald. "Bounding the Practical Error of Path Loss Models." *International Journal of Antennas and Propagation*, Volume 2012 (2012). Retrieved 17 May 2021. Available at <https://www.hindawi.com/journals/ijap/2012/754158/>.
- Proakis, J. G. and M. Salehi. *Digital Communications*. 5th Edition. Boston: McGraw-Hill, 2008.
- R. Clewer. "Report on the Status of Development of the High Speed Digital Satellite modem", RML-009-79-24, Spar Aerospace Limited, St. Anne de Bellevue, P.Q., Canada, November 1979. Quoted in Kamilo Feher. *Digital Communications: Satellite/Earth Station Engineering*. Englewood Cliffs: Prentice-Hall, 1983.
- Range Commanders Council. "Application for Equipment Frequency Allocation for Aeronautical Mobile Telemetry Systems." In *Telemetry Systems Radio Frequency Handbook*, Appendix A. RCC 120-21. July 2021. May be superseded by update. Retrieved July 10 2021. Available at <https://www.trmc.osd.mil/wiki/x/iYu8Bg>.
- . *Test Methods for Telemetry Systems and Subsystems Volume 2*. RCC 118-20. June 2020. May be superseded by update. Retrieved 17 May 2021. Available at <https://www.trmc.osd.mil/wiki/x/flu8Bg>.
- Rice, M., A. Davis, and C. Bettweiser. "Wideband channel model for aeronautical telemetry." *IEEE Transactions on Aerospace and Electronic Systems*, vol. 40, no. 1, pp. 57–69, January 2004.
- Rice, M. and J. Ebert. "Derivation and analysis of the IRIG-106 dynamic multipath channel model," in *Proceedings of the International Telemetry Conference*, Las Vegas, NV, 25-28 October 2021 (forthcoming).
- Rice, M. and K. Temple, "Space-Time Coding for Aeronautical Telemetry: part II – Experimental Results." *Proceedings of the International Telemetry Conference*, Las Vegas, NV, October 2011.
- Rice, M., J. Palmer, C. Lavin, and T. Nelson. "Space-Time Coding for Aeronautical Telemetry: Part I – Estimators." *IEEE Transactions on Aerospace and Electronic Systems*, vol. 53, no. 4, pp. 1709-1731, August 2017.
- Rice, M., T. Nelson, J. Palmer, C. Lavin, and K. Temple. "Space-Time Coding for Aeronautical Telemetry: Part II – Decoder and System Performance." *IEEE Transactions on Aerospace and Electronic Systems*, vol. 53, no. 4, pp. 1732-1754, August 2017.
- S. Alamouti. "A Simple Transmit Diversity Technique for Wireless Communications." *IEEE Journal on Selected Areas in Communications*, vol. 16, no. 8, pp. 1451-1458, October 1998.
- Spirent. SR5500 Wireless Channel Emulator User Manual. Copyright 2011. 71-003547, Version A7. May be superseded by update. Retrieved 17 May 2021. Available at [https://support-kb.spirent.com/resources/sites/SPIRENT/content/live/DOCUMENTATION/10000/DOC10397/en\\_US/UM\\_SR5500\\_v3\\_50\\_A7.pdf](https://support-kb.spirent.com/resources/sites/SPIRENT/content/live/DOCUMENTATION/10000/DOC10397/en_US/UM_SR5500_v3_50_A7.pdf).

T. J. Hill. "An Enhanced, Constant Envelope, Interoperable Shaped Offset QPSK (SOQPSK) Waveform for Improved Spectral Efficiency." Paper presented during 36th Annual International Telemetry Conference, San Diego, CA. October 23-26, 2000.

Telecommunications Industry Association. *Interface between Data Terminal Equipment and Data Circuit-Terminating Equipment Employing Serial Binary Data Interchange*. TIA/EIA-232-F. 1 October 1997. May be superseded by update. Retrieved 17 May 2021. Available at <https://standards.globalspec.com/std/872822/tia-232>.

Tey, W. M. and T. Tjhung. "Characteristics of Manchester Coded FSK." *IEEE Transactions on Communications*, Vol. COM 27, pp. 209 216, January 1979.

Thomas Schwengler. "Radio Propagation Modeling." Chapter 3 in *Wireless and Cellular Communications*. Retrieved 17 May 2021. Available at <http://morse.colorado.edu/~tlen5510/text/classwebch3.html>.

W. J. Weber III. "Differential Encoding for Multiple Amplitude and Phase Shift Keying Systems." *IEEE Transactions on Communications*, Vol. COM-26, No. 3, March 1978.

Wang, C. W. and T. Keech. *Antenna Models For Electromagnetic Compatibility Analyses*, NTIA Report TM-13-489. October 2012. Retrieved 17 May 2021. Available at <https://www.ntia.doc.gov/report/2012/antenna-models-electromagnetic-compatibility-analyses>.

Watt, A. D., V. J. Zurick, and R. M. Coon. "Reduction of Adjacent Channel Interference Components from Frequency Shift Keyed Carriers." *IRE Transactions on Communication Systems*, Vol. CS 6, pp. 39 47, December 1958.

Wikipedia. "Rayleigh fading." Retrieved 17 May 2021. Available at [https://en.wikipedia.org/wiki/Rayleigh\\_fading](https://en.wikipedia.org/wiki/Rayleigh_fading)

Wireless Communications Association, "4G Device Out of Band Emissions and Larger Channel Bandwidths." October 2011. Retrieved 17 May 2021. Available at <https://ecfsapi.fcc.gov/file/7021715550.pdf>.

**\*\*\*\* END OF CHAPTER 2 \*\*\*\***

## CHAPTER 3

### Frequency Division Multiplexing Telemetry Standards

Acronyms.....	3-iii
Chapter 3. Frequency Division Multiplexing Telemetry Standards .....	3-1
3.1 General.....	3-1
3.2 FM Subcarrier Characteristics.....	3-1
3.3 FM Subcarrier Channel Characteristics .....	3-1
3.3.1 Proportional-Bandwidth FM Subcarrier Channel Characteristics .....	3-1
3.3.2 Constant-Bandwidth FM Subcarrier Channel Characteristics .....	3-4
3.4 Tape Speed Control and Flutter Compensation .....	3-4
Appendix 3-A. Use Criteria for Frequency Division Multiplexing.....	A-1
Appendix 3-B. Citations.....	B-1

#### List of Tables

Table 3-1. Proportional-Bandwidth FM Subcarrier Channels $\pm 7.5\%$ Channels .....	3-2
Table 3-2. Proportional-Bandwidth FM Subcarrier Channel $\pm 15\%$ Channels .....	3-2
Table 3-3. Proportional-Bandwidth FM Subcarrier Channels $\pm 30\%$ Channels .....	3-3
Table 3-4. Constant-Bandwidth FM Subcarrier Channels .....	3-5
Table 3-5. Reference Signal Usage .....	3-6

This page intentionally left blank.



## Acronyms

dB	decibel
FM	frequency modulation
IF	intermediate frequency
Hz	hertz
kHz	kilohertz
ms	millisecond
RF	radio frequency
rms	root mean square
SNR	signal-to-noise ratio

This page intentionally left blank.

## CHAPTER 3

### Frequency Division Multiplexing Telemetry Standards

 <p><b>NOTE</b></p>	<p>This chapter contains standards for analog frequency modulation (FM) data, specifically dealing with frequency division multiplexing and subcarrier channels. It is readily apparent that the use of analog data has been superseded by digital data to a large extent. Therefore, while the standards in this chapter are valid for any and all FM data still in use, further development pertaining to FM data is not supported or encouraged.</p>
--	---

#### 3.1 General

In frequency division multiplexing, each data channel makes use of a separate subcarrier that occupies a defined position and bandwidth in the modulation baseband of the radio frequency (RF) carrier. Two types of FM subcarrier formats may be used. The data bandwidth of one format type is proportional to the subcarrier center frequency, while the data bandwidth of the other type is constant, regardless of subcarrier frequency.

#### 3.2 FM Subcarrier Characteristics

In these systems, one or more subcarrier signals, each at a different frequency, are employed to frequency-modulate or phase-modulate a transmitter in accordance with the RF conditions specified in [Chapter 2](#). The following subparagraphs set forth the standards for utilization of FM frequency division multiplexing.

Each of the subcarriers conveys measurement data in FM form. The number of data channels may be increased by modulating one or more of the subcarriers with a time-division multiplex format such as pulse code modulation.

The selecting and grouping of subcarrier channels depend upon the data bandwidth requirements of the application at hand and upon the necessity to ensure adequate guard bands between channels. Combinations of both proportional-bandwidth channels and constant-bandwidth channels may be used.

#### 3.3 FM Subcarrier Channel Characteristics

The following subparagraphs describe the characteristics of proportional-bandwidth and constant-bandwidth FM subcarrier channels.

##### 3.3.1 Proportional-Bandwidth FM Subcarrier Channel Characteristics

[Table 3-1](#), [Table 3-2](#), and [Table 3-3](#) list the standard proportional-bandwidth FM subcarrier channels. The channels identified with letters permit  $\pm 15$  or  $\pm 30$  percent subcarrier deviation rather than  $\pm 7.5$  percent deviation but use the same frequencies as the 12 highest channels. The channels shall be used within the limits of maximum subcarrier deviation. See [Appendix 3-A](#) for expected performance tradeoffs at selected combinations of deviation and modulating frequency.

<b>Table 3-1. Proportional-Bandwidth FM Subcarrier Channels <math>\pm 7.5\%</math> Channels</b>							
Channel	Center Frequencies (hertz [Hz])	Lower Deviation Limit (Hz)	Upper Deviation Limit (Hz)	Nominal Frequency Response (Hz)	Nominal Rise Time (millisecond [ms])	Maximum Frequency Response (Hz)	Minimum Rise Time (ms)
1	400	370	430	6	58	30	11.7
2	560	518	602	8	44	42	8.33
3	730	675	785	11	32	55	6.40
4	960	888	1032	14	25	72	4.86
5	1300	1202	1398	20	18	98	3.60
6	1700	1572	1828	25	14	128	2.74
7	2300	2127	2473	35	10	173	2.03
8	3000	2775	3225	45	7.8	225	1.56
9	3900	3607	4193	59	6.0	293	1.20
10	5400	4995	5805	81	4.3	405	0.864
11	7350	6799	7901	110	3.2	551	0.635
12	10,500	9712	11,288	160	2.2	788	0.444
13	14,500	13,412	15,588	220	1.6	1088	0.322
14	22,000	20,350	23,650	330	1.1	1650	0.212
15	30,000	27,750	32,250	450	0.78	2250	0.156
16	40,000	37,000	43,000	600	0.58	3000	0.117
17	52,500	48,562	56,438	788	0.44	3938	0.089
18	70,000	64,750	75,250	1050	0.33	5250	0.06
19	93,000	86,025	99,975	1395	0.25	6975	0.050
20	124,000	114,700	133,300	1860	0.19	9300	0.038
21	165,000	152,625	177,375	2475	0.14	12,375	0.029
22	225,000	208,125	241,875	3375	0.10	16,875	0.021
23	300,000	277,500	322,500	4500	0.08	22,500	0.016
24	400,000	370,000	430,000	6000	0.06	30,000	0.012
25	560,000	518,000	602,000	8400	0.04	42,000	0.008
See notes at end of <a href="#">Table 3-3</a> .							

<b>Table 3-2. Proportional-Bandwidth FM Subcarrier Channel <math>\pm 15\%</math> Channels</b>							
Channel	Center Frequencies (Hz)	Lower Deviation Limit (Hz)	Upper Deviation Limit (Hz)	Nominal Frequency Response (Hz)	Nominal Rise Time (ms)	Maximum Frequency Response (Hz)	Minimum Rise Time (ms)
A	22,000	18,700	25,300	660	0.53	3300	0.106
B	30,000	25,500	34,500	900	0.39	4500	0.078
C	40,000	34,000	46,000	1200	0.29	6000	0.058

D	52,500	44,625	60,375	1575	0.22	7875	0.044
E	70,000	59,500	80,500	2100	0.17	10,500	0.033
F	93,000	79,050	106,950	2790	0.13	13,950	0.025
G	124,000	105,400	142,600	3720	0.09	18,600	0.018
H	165,000	140,250	189,750	4950	0.07	24,750	0.014
I	225,000	191,250	258,750	6750	0.05	33,750	0.010
J	300,000	255,000	345,000	9000	0.04	45,000	0.008
K	400,000	340,000	460,000	12,000	0.03	60,000	0.006
L	560,000	476,000	644,000	16,800	0.02	84,000	0.004

See notes at end of [Table 3-3](#).

<b>Table 3-3. Proportional-Bandwidth FM Subcarrier Channels ±30% Channels</b>							
Channel	Center Frequencies (Hz)	Lower Deviation Limit (Hz)	Upper Deviation Limit (Hz)	Nominal Frequency Response (Hz)	Nominal Rise Time (ms)	Maximum Frequency Response (Hz)	Minimum Rise Time (ms)
AA	22,000	15,400	28,600	1320	0.265	6600	0.053
BB	30,000	21,000	39,000	1800	0.194	9000	0.038
CC	40,000	28,000	52,000	2400	0.146	12,000	0.029
DD	52,500	36,750	68,250	3150	0.111	15,750	0.022
EE	70,000	49,000	91,000	4200	0.083	21,000	0.016
FF	93,000	65,100	120,900	5580	0.063	27,900	0.012
GG	124,000	86,800	161,200	7440	0.047	37,200	0.009
HH	165,000	115,500	214,500	9900	0.035	49,500	0.007
II	225,000	157,500	292,500	13,500	0.026	67,500	0.005
JJ	300,000	210,000	390,000	18,000	0.019	90,000	0.004
KK	400,000	280,000	520,000	24,000	0.015	120,000	0.003
LL	560,000	392,000	728,000	33,600	0.010	168,000	0.002

Notes:

1. Round off to nearest Hz.
2. The indicated maximum data frequency response and minimum rise time is based on the maximum theoretical response that can be obtained in a bandwidth between the upper and lower frequency limits specified for the channels. See Paragraph [A.3](#) for determining possible accuracy versus response tradeoffs.
3. Channels A through L may be used by omitting adjacent lettered and numbered channels. Channels 13 and A may be used together with some increase in adjacent channel interference.
4. Channels AA through LL may be used by omitting every four adjacent double lettered and lettered channels and every three adjacent numbered channels. Channels AA through LL may be used by omitting every three adjacent double lettered and lettered channels and every two adjacent numbered channels with some increase in adjacent channel interference.

### 3.3.2 Constant-Bandwidth FM Subcarrier Channel Characteristics

[Table 3-4](#) lists the standard constant-bandwidth FM subcarrier channels. The letters A, B, C, D, E, F, G, and H identify the channels for use with maximum subcarrier deviations of  $\pm 2$ ,  $\pm 4$ ,  $\pm 8$ ,  $\pm 16$ ,  $\pm 32$ ,  $\pm 64$ ,  $\pm 128$ , and  $\pm 256$  kilohertz (kHz), along with maximum frequency responses of 2, 4, 8, 16, 32, 64, 128, and 256 kHz. The channels shall be used within the limits of maximum subcarrier deviation. See [Appendix 3-A](#) for expected performance tradeoffs at selected combinations of deviation and modulating frequencies.

### 3.4 **Tape Speed Control and Flutter Compensation**

Tape speed control and flutter compensation for FM/FM formats may be accomplished as indicated in [Annex A.2](#), Subsection 17.4. The standard reference frequency used shall be in accordance with the criteria in [Table 3-5](#) when the reference signal is mixed with data.

<b>Table 3-4. Constant-Bandwidth FM Subcarrier Channels</b>								
Frequency Criteria\Channels:	A	B	C	D	E	F	G	H
Deviation Limits (kHz)	±2	±4	±8	±16	±32	±64	±128	±256
Nominal Frequency Response (kHz)	0.4	0.8	1.6	3.2	6.4	12.8	25.6	51.2
Maximum Frequency Response (kHz)	2	4	8	16	32	64	128	256
<p>Notes:</p> <p>The constant-bandwidth channel designation shall be the channel center frequency in kilohertz and the channel letter indicating deviation limit; for example, 16A, indicating <math>f_c = 16</math> kHz, deviation limit of ±2 kHz.</p> <p>The indicated maximum frequency is based upon the maximum theoretical response that can be obtained in a bandwidth between deviation limits specified for the channel. See discussion in <a href="#">Appendix 3-A</a> for determining practical accuracy versus frequency response tradeoffs.</p> <p>Prior to using a channel outside the shaded area, the user should verify the availability of range assets to support the demodulation of the channel selected. Very limited support is available above 2 megahertz.</p>	Center Frequency (kHz)							
	8	16	32	64	128	256	512	1024
	16	32	64	128	256	512	1024	2048
	24	48	96	192	384	768	1536	3072
	32	64	128	256	512	1024	2048	
	40	80	160	320	640	1280	2560	
	48	96	192	384	768	1536	3072	
	56	112	224	448	896	1792	3584	
	64	128	256	512	1024	2048		
	72	144	288	576	1152	2304		
	80	160	320	640	1280	2560		
	88	176	352	704	1408	2816		
	96	192	384	768	1536	3072		
	104	208	416	832	1664	3328		
	112	224	448	896	1792	3584		
	120	240	480	960	1920	3840		
	128	256	512	1024	2048			
	136	272	544	1088	2176			
	144	288	576	1152	2304			
	152	304	608	1216	2432			
160	320	640	1280	2560				
168	336	672	1344	2688				
176	352	704	1408	2816				

<b>Table 3-5. Reference Signal Usage</b>	
<b>Reference Frequencies for Tape Speed and Flutter Compensation</b>	
<u>Reference Frequency (kHz ±0.01%)</u>	
	960 <sup>(1)</sup>
	480 <sup>(1)</sup>
	240 <sup>(1)</sup>
	200
	100
	50
	25
	12.5
	6.25
	3.125
Note: <sup>(1)</sup> These frequencies are for flutter compensation only and not for capstan servo speed control. In addition, the 240 kHz reference signal may be used as a detranslation frequency in a constant-bandwidth format.	

If the reference signal is recorded on a separate tape track, any of the listed reference frequencies may be used provided the requirements for compensation rate of change are satisfied.

If the reference signal is mixed with the data signal, consideration must be given to possible problems with intermodulation sum and difference frequencies. Also, sufficient guard band must be allowed between the reference frequency and any adjacent data subcarrier.



## APPENDIX 3-A

### Use Criteria for Frequency Division Multiplexing

#### A.1. General

Successful application of frequency division multiplexing telemetry standards depends on recognition of performance limits and performance tradeoffs, which may be required in implementation of a system. The use criteria included in this appendix are offered in this context as a guide for orderly application of the standards presented above. It is the responsibility of the telemetry system designer to select the range of performance that will meet data measurement requirements and at the same time permit operation within the limits of the standards. A designer or user must also recognize the fact that even though the standards for FM/FM multiplexing encompass a broad range of performance limits, tradeoffs such as data accuracy for data bandwidth may be necessary. Nominal values for such parameters as frequency response and rise time are listed to indicate the majority of expected use and should not be interpreted as inflexible operational limits. It must be remembered that system performance is influenced by other considerations such as hardware performance capabilities. In summary, the scope of the standards together with the use criteria is intended to offer flexibility of operation and yet provide realistic limits.

#### A.2. FM Subcarrier Performance

The nominal and maximum frequency response of the subcarrier channels listed in [Table 3-1](#), [Table 3-2](#), [Table 3-3](#), and [Table 3-4](#) is 10 and 50 percent of the maximum allowable deviation bandwidth. The nominal frequency response of the channels employs a deviation ratio of five. The deviation ratio of a channel is one-half the defined deviation bandwidth divided by the cutoff frequency of the discriminator output filter.

The use of other deviation ratios for any of the subcarrier channels listed may be selected by the range users to conform to the specific data response requirements for the channel. As a rule, the root mean square (rms) signal-to-noise ratio (SNR) of a specific channel varies as the three-halves power of that subcarrier deviation ratio.

The nominal and minimum channel rise times indicated in the tables listed above have been determined from the equation which states that rise time is equal to 0.35 divided by the frequency response for the nominal and maximum frequency response. The equation is normally employed to define 10 to 90 percent rise time for a step function of the channel input signal; however, deviations from these values may be encountered because of variations in subcarrier components in the system.

#### A.3. FM Subcarrier Performance Tradeoffs

The number of subcarrier channels that may be used simultaneously to modulate an RF carrier is limited by the RF channel bandwidth and by the output SNR that is acceptable for the application at hand. As channels are added, it is necessary to reduce the transmitter deviation allowed for each individual channel to keep the overall multiplex with the RF channel assignment. This reduction lowers the subcarrier-to-noise performance at the discriminator

inputs. Thus, the system designer's problem is to determine acceptable tradeoffs between the number of subcarrier channels and acceptable subcarrier-to-noise ratios.

Background information relating to the level of performance and the tradeoffs that may be made is included in Telemetry FM/FM Baseband Structure Study, volumes I and II<sup>1</sup>; which were completed under a contract administered by the Telemetry Working Group of the Inter-Range Instrumentation Group in 1965. The results of the study show that proportional bandwidth channels with center frequencies up to 165 kilohertz (kHz) and constant bandwidth channels with center frequencies up to 176 kHz may be used within the constraints of these standards. The test criteria included the adjustment of the system components for approximately equal SNRs at all of the discriminator outputs with the receiver input near RF threshold. Intermodulation, caused by the radio-link components carrying the composite multiplex signal, limits the channel's performance under large signal conditions.

With subcarrier deviation ratios of four, channel data errors on the order of 2 percent rms were observed. Data channel errors on the order of 5 percent rms of full-scale bandwidth were observed when subcarrier deviation ratios of two were employed. When deviation ratios of one were used, it was observed that channel-data errors exceeded 5 percent. Some channels showed peak-to-peak errors as high as 30 percent. It must be emphasized, however, that the results of the tests performed in this study are based on specific methods of measurement on one system sample and that this system sample represents a unique configuration of components. Systems having different performance characteristics may not yield the same system performance.

System performance may be improved, in terms of better data accuracy, by sacrificing system data bandwidth; that is, if the user is willing to limit the number of subcarrier channels in the multiplex, particularly the higher frequency channels, the input level to the transmitter can be increased. The SNR of each subcarrier is then improved through the increased per-channel transmitter deviation. For example, the baseband structure study indicated that when the 165-kHz channel and the 93-kHz channel were not included in the proportional-bandwidth multiplex, performance improvement can be expected in the remaining channels equivalent to approximately 12 decibels (dB) increased transmitter power.

Likewise, elimination of the five highest frequency channels in the constant bandwidth multiplex allowed a 6-dB increase in performance.

A general formula,<sup>2</sup> which can be used to estimate the thermal noise performance of an FM/FM channel above threshold, is as follows:

$$\left(\frac{S}{N}\right)_d = \left(\frac{S}{N}\right)_c \left(\frac{3}{4}\right)^{1/2} \left[\frac{B_c}{F_{ud}}\right]^{1/2} \left(\frac{f_{dc}}{f_s}\right) \left(\frac{f_{ds}}{F_{ud}}\right) \quad \text{Eqn. B-1}$$

where  $\left(\frac{S}{N}\right)_d$  = discriminator output signal-to-noise ratio (rms voltage ratio)

<sup>1</sup> Campbell, E. B. and W. R. Hubert. *Telemetry FM/FM Baseband Structure Study*. 2 vols. 14 June 1965. 17 May 2021. Available at <https://apps.dtic.mil/sti/pdfs/AD0621139.pdf> and <https://apps.dtic.mil/sti/pdfs/AD0621140.pdf>.

<sup>2</sup> K. M. Uglow. "Noise and Bandwidth in FM/FM Radio Telemetry", in *IRE Transactions on Telemetry and Remote Control*, (May 1957) pp 19-22.

$$\left(\frac{S}{N}\right)_c = \text{receiver carrier-to-noise ratio (rms voltage ratio)}$$

$B_c$  = carrier bandwidth (receiver intermediate frequency bandwidth)

$F_{ud}$  = subcarrier discriminator output filter: 3-dB frequency

$f_s$  = subcarrier center frequency

$f_{dc}$  = carrier peak deviation of the particular subcarrier of interest

$f_{ds}$  = subcarrier peak deviation

If the RF carrier power is such that the thermal noise is greater than the intermodulation noise, the above relation provides estimates accurate to within a few decibels. Additional information is contained in RCC Document 119, *Telemetry Applications Handbook*.<sup>3</sup>

The FM/FM composite-multiplex signal used to modulate the RF carrier may be a proportional-bandwidth format, a constant-bandwidth format, or a combination of the two types provided only that guard bands allowed for channels used in a mixed format be equal to or greater than the guard band allowed for the same channel in an unmixed format.

#### A.4. FM System Component Considerations

System performance is dependent on all components in the system. Neglecting the effects of the RF and recording system, data channel accuracy is primarily a function of the linearity and frequency response of the subcarrier oscillators and discriminators employed. Systems designed to transmit data frequencies up to the nominal frequency responses shown in [Table 3-1](#), [Table 3-2](#), [Table 3-3](#), and [Table 3-4](#) have generally well-known response capabilities, and reasonable data accuracy estimates can be easily made. For data-channel requirements approaching the maximum frequency response shown in the tables listed above, oscillator and discriminator characteristics are less consistent and less well-defined, making data accuracy estimates less dependable.

The effect of the RF system on data accuracy is primarily in the form of noise because of intermodulation at high RF signal conditions well above threshold. Under low RF signal conditions, noise on the data channels is increased because of the degraded SNR existing in the receiver.

Intermodulation of the subcarriers in a system is caused by characteristics such as amplitude and phase nonlinearities of the transmitter, receiver, magnetic tape recorder/reproducer, or other system components required to handle the multiplex signal under the modulation conditions employed. In systems employing pre-emphasis of the upper subcarriers, the lower subcarriers may experience intermodulation interference because of the difference frequencies of the high-frequency and high-amplitude channels.

The use of magnetic tape recorders for recording a subcarrier multiplex may degrade the data channel accuracy because of the tape speed differences or variations between record and playback. These speed errors can normally be compensated for in present discriminator systems

---

<sup>3</sup> Range Commanders Council. *Telemetry Applications Handbook*. RCC 119-06. May 2006. May be superseded by update. Retrieved 17 May 2021. Available at <https://www.trmc.osd.mil/wiki/x/h4u8Bg>.

when the nominal response rating of the channels is employed and a reference frequency is recorded with the subcarrier multiplex.

#### **A.5. Range Capability for FM Subcarrier Systems**

The following subparagraphs outline additional range capabilities.

##### **A.5.a. Receivers and Tape Recorders.**

The use of subcarrier frequencies greater than 2 megahertz may require tape recorders of a greater capability than are in current use at some ranges. It is recommended that users, who anticipate employing any of the above channels at a range, check the range's capability at a sufficiently early date to allow procurement of necessary equipment.

##### **A.5.b. Discriminator Channel Selection Filters.**

Inclusion of the higher frequency proportional-bandwidth channels and the constant-bandwidth channels may require the ranges to acquire additional band selection filters. In addition to referencing [Table 3-1](#), [Table 3-2](#), [Table 3-3](#), and [Table 3-4](#) for acquiring channel-selector filters, consideration should also be given to acquiring discriminators corresponding to the predetection carrier frequencies shown in [Annex A.2](#), Table A.2-9. In applications where minimum time delay variation within the filter is important, such as tape speed compensation or high-rate pulse amplitude modulation or pulse code modulation, constant-delay filter designs are recommended.

## APPENDIX 3-B

### Citations

Campbell, E. B. and W. R. Hubert. *Telemetry FM/FM Baseband Structure Study*. 2 vols. 14 June 1965. Retrieved 17 May 2021. Available at <https://apps.dtic.mil/sti/pdfs/AD0621139.pdf> and <https://apps.dtic.mil/sti/pdfs/AD0621140.pdf>.

K. M. Uglow. "Noise and Bandwidth in FM/FM Radio Telemetry" in *IRE Transactions on Telemetry and Remote Control*, May 1957, pp 19-22.

Range Commanders Council. *Telemetry Applications Handbook*. RCC 119-06. May 2006. May be superseded by update. Retrieved 17 May 2021. Available at <https://www.trmc.osd.mil/wiki/x/h4u8Bg>.

**\*\*\*\* END OF CHAPTER 3 \*\*\*\***

## CHAPTER 4

### Pulse Code Modulation Standards

<b>Acronyms</b> .....	<b>4-iii</b>
<b>Chapter 4. Pulse Code Modulation Standards</b> .....	<b>4-1</b>
<b>4.1 General</b> .....	<b>4-1</b>
<b>4.2 Class Distinctions and Bit-Oriented Characteristics</b> .....	<b>4-1</b>
4.2.1 Class I and Class II Distinctions .....	4-1
4.2.2 Bit-Oriented Definitions and Requirements .....	4-2
4.2.3 Bit Clocking Definitions and Requirements .....	4-4
<b>4.3 Fixed Formats</b> .....	<b>4-5</b>
4.3.1 Word-Oriented Definitions and Requirements .....	4-5
4.3.2 Frame Structure.....	4-6
4.3.3 Cyclic Redundancy Check (Class II) .....	4-8
<b>4.4 Format Change (Class II)</b> .....	<b>4-9</b>
4.4.1 Frame Format Identification .....	4-9
4.4.2 Format Change Implementation Methods .....	4-9
<b>4.5 Asynchronous Embedded Format (Class II)</b> .....	<b>4-9</b>
<b>4.6 Tagged Data Format (Class II)</b> .....	<b>4-9</b>
4.6.1 Alternating Tag and Data.....	4-9
4.6.2 Bus Data, MIL-STD 1553.....	4-10
4.6.3 Bus Data, ARINC 429 .....	4-10
<b>4.7 Time Words</b> .....	<b>4-10</b>
<b>4.8 Asynchronous Data Merge (Class II)</b> .....	<b>4-12</b>
4.8.1 PCM Data Word Format.....	4-12
4.8.2 Insertion Process .....	4-12
<b>Appendix 4-A. Additional Information and Recommendations</b> .....	<b>A-1</b>
<b>A.1. Bit Rate Versus Receiver Intermediate-Frequency Bandwidth</b> .....	<b>A-1</b>
<b>A.2. Recommended PCM Synchronization Patterns</b> .....	<b>A-2</b>
<b>A.3. Spectral and BEP Comparisons for NRZ and Bi-phase</b> .....	<b>A-3</b>
<b>A.4. PCM Frame Structure Examples</b> .....	<b>A-4</b>
<b>Appendix 4-B. Citations</b> .....	<b>B-1</b>

#### List of Figures

Figure 4-1. PCM Code Definitions.....	4-3
Figure 4-2. PCM Clock Definitions.....	4-4
Figure 4-3. PCM Frame Structure .....	4-6

Figure 4-4. 16-Bit Standardized Time Word Format ..... 4-10  
Figure 4-5. Time Word Insertion into 12-Bit PCM Word Size..... 4-11  
Figure 4-6. Asynchronous Word Structure..... 4-12  
Figure A-1. BEP vs. IF SNR in Bandwidth = Bit Rate for NRZ-L PCM/FM ..... A-1  
Figure A-2. Spectral Densities of Random NRZ and Biφ Codes..... A-3  
Figure A-3. Theoretical BEP Performance for Various Baseband PCM Signaling  
Techniques (Perfect Bit Synchronization Assumed) ..... A-4

**List of Tables**

Table 4-1. Overhead Truth Table ..... 4-13  
Table A-1. Optimum Frame Synchronization Patterns for PCM Telemetry ..... A-2  
Table A-2. Minor Frame Maximum Length, N Words or B Bits ..... A-5  
Table A-3. Major Frame Length = Minor Frame Maximum Length Multiplied by Z ..... A-6  
Table A-4. Major Frame Length = Minor Frame Maximum Length Multiplied by Z ..... A-7



## Acronyms

BCD	binary coded decimal
BEP	bit error probability
Bi $\phi$	bi-phase
Bi $\phi$ -L	bi-phase-level
Bi $\phi$ -M	bi-phase-mark
Bi $\phi$ -S	bi-phase-space
CRC	cyclic redundancy check
dB	decibel
FFI	frame format identifier
FM	frequency modulation
IF	intermediate-frequency
lsb	least significant bit
Mbps	megabit per second
msb	most significant bit
NRZ-L	non-return-to-zero-level
NRZ-M	non-return-to-zero-mark
NRZ-S	non-return-to-zero-space
PCM	pulse code modulation
RF	radio frequency
RNRZ-L	randomized non-return-to-zero-level
SFID	subframe identifier
SNR	signal-to-noise ratio

This page intentionally left blank.

## CHAPTER 4

### Pulse Code Modulation Standards

#### 4.1 General

Pulse code modulation (PCM) data are transmitted as a serial bit stream of binary-coded time-division multiplexed words. When PCM is transmitted, premodulation filtering shall be used to confine the radiated radio frequency (RF) spectrum in accordance with [Chapter 2](#) Appendix 2-A. These standards define pulse train structure and system design characteristics for the implementation of PCM telemetry formats. Additional information and recommendations are provided in [Appendix 4-A](#) and in RCC 119-06.<sup>1</sup>

#### 4.2 Class Distinctions and Bit-Oriented Characteristics

The PCM formats are divided into two classes for reference. Serial bit stream characteristics are described below prior to frame and word oriented definitions.

##### 4.2.1 Class I and Class II Distinctions

Two classes of PCM formats are covered in this chapter: the basic, simpler types are Class I, and the more complex applications are Class II. The use of any Class II technique requires concurrence of the range involved. All formats with characteristics described in these standards are Class I except those identified as Class II. The following are examples of Class II characteristics.

- a. Bit rates greater than 10 megabits per second (Mbps) (Subsection [4.2.2](#) item [c](#)).
- b. Word lengths in excess of 32 bits (Subsection [4.3.1](#) item [a](#)).
- c. Fragmented words (Subsection [4.3.1](#) item [b](#)).
- d. More than 8192 bits or 1024 words per minor frame (Subsection [4.3.2](#) item [a\(1\)](#)).
- e. Uneven spacing, not within the definition of subcommutation (Subsection [4.3.2](#) item [c](#)) or supercommutation (Subsection [4.3.2](#) item [d](#)).
- f. Format changes (Section [4.4](#)).
- g. Asynchronous embedded formats (Paragraph [4.5](#)).
- h. Tagged data formats (Section [4.6](#)).
- i. Formats with data content other than unsigned straight binary, discretized, or complement arithmetic representation for negative numbers such as floating point variables, binary-coded decimal, and gain-and-value.
- j. Asynchronous data transmission (Section [4.8](#)).
- k. Merger of multiple format types (such as those specified in [Chapter 8](#)).
- l. Use of a cyclic redundancy check (CRC) word (Subsection [4.3.3](#)).

---

<sup>1</sup> Range Commanders Council. *Telemetry Applications Handbook*. RCC 119-06. May 2006. May be superseded by update. Retrieved 17 May 2021. Available at <https://www.trmc.osd.mil/wiki/x/h4u8Bg>.

- m. Use of fill bits (Subsection [4.3.2](#) item [a](#)).
- n. Use of non-fixed frame synchronization patterns.

 <b>NOTE</b>	The use of fixed frame formats has been a common practice but does not fit all requirements. A verification of range capabilities should be made prior to incorporation of Class II features into a telemetry system.
---	---

#### 4.2.2 Bit-Oriented Definitions and Requirements

Definitions and requirements relating to serial PCM bit streams are described next.

- a. Binary Bit Representation. The following code conventions for representing serial binary ones and zeros are the only permissible representations. Graphic and written descriptions of these conventions are shown in [Figure 4-1](#). Only one convention shall be used within a single PCM bit stream. If randomized non-return-to-zero-level (RNRZ-L) is transmitted, it shall use the 15-bit regeneration pattern as described in [Annex A-2](#).
  - (1) Non-return-to-zero-level (NRZ-L)
  - (2) Non-return-to-zero-mark (NRZ-M)
  - (3) Non-return-to-zero-space (NRZ-S)
  - (4) Bi-phase-level (Bi $\phi$ -L)
  - (5) Bi-phase-mark (Bi $\phi$ -M)
  - (6) Bi-phase-space (Bi $\phi$ -S)

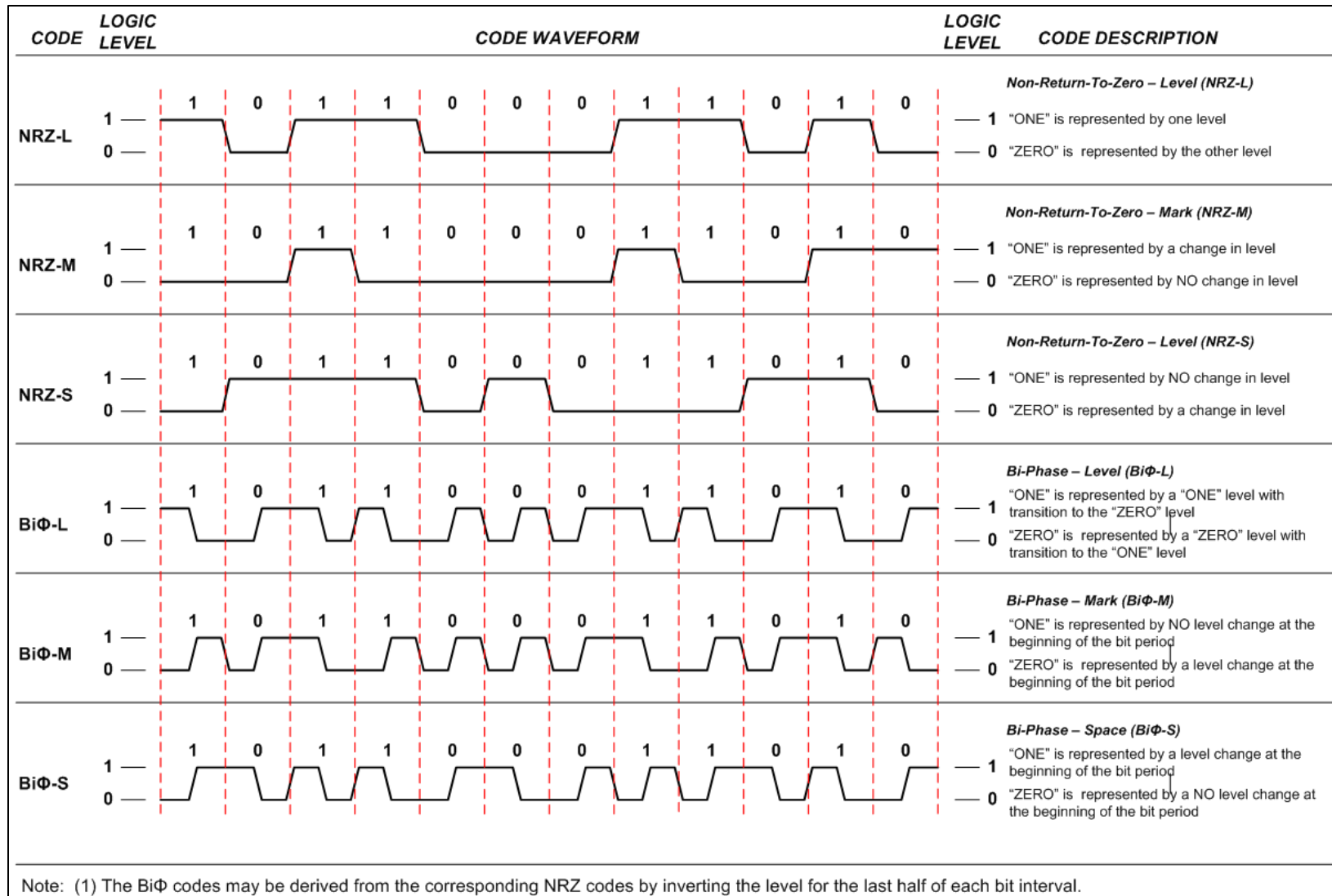

Figure 4-1. PCM Code Definitions

- b. Serial Bit Stream Transitions. The transmitted or recorded bit stream shall be continuous and shall contain sufficient transitions to ensure bit acquisition and continued bit synchronization, taking into account the binary representation chosen. See the recommendation in Section [A.3](#).
- c. Bit Rate. The RF and recording limits, defined in [Chapter 2](#) and [Chapter 6](#), should be considered when determining maximum bit rates. The minimum bit rate shall be 10 bits per second. Bit rates greater than 10 Mbps are Class II.
- d. Bit Rate Accuracy and Stability. During any period of desired data, the bit rate shall not differ from the specified nominal bit rate by more than 0.1 percent of the nominal rate.
- e. Bit Jitter. The bit jitter shall not exceed  $\pm 0.1$  of a bit interval referenced to the expected transition time with no jitter. The expected transition time shall be based on the measured average bit period as determined during the immediately preceding 1000 bits.

#### 4.2.3 Bit Clocking Definitions and Requirements

Clock phase is defined in relationship to data transition. Graphic and written descriptions of following conventions are shown in [Figure 4-2](#).

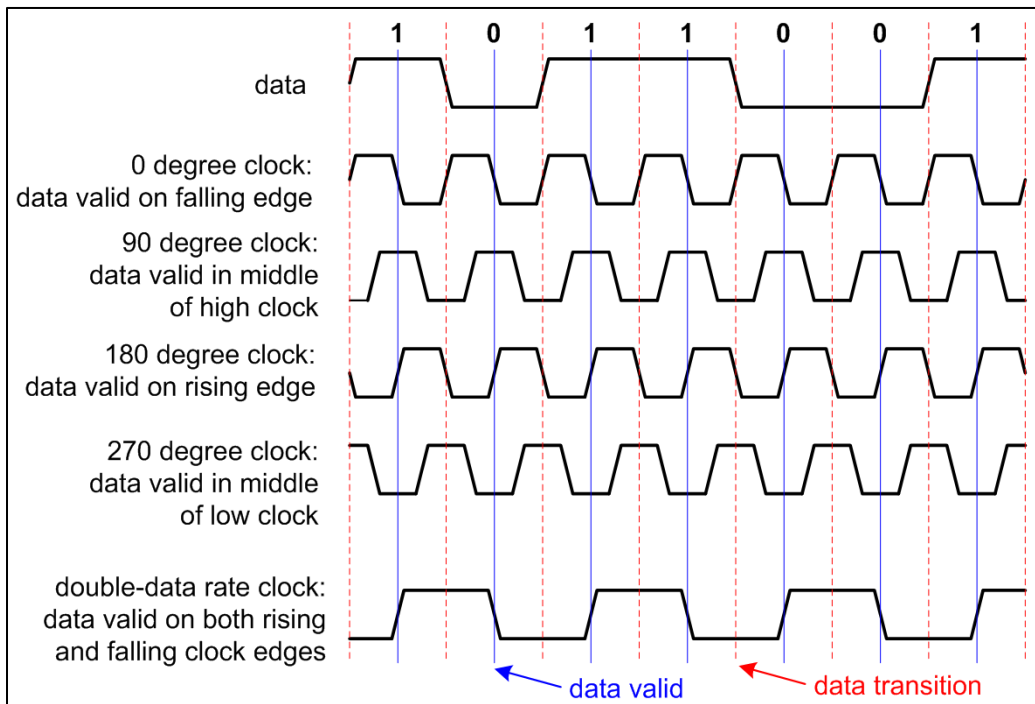

Figure 4-2. PCM Clock Definitions

- a.  $0^\circ$  clock. Data transitions on the rising edge of the clock. Data is valid on the falling edge of the clock.
- a.  $90^\circ$  clock. Data transitions in the middle of clock low. Data is valid in the middle of clock high.
- b.  $180^\circ$  clock. Data transitions on the falling edge of the clock. Data is valid on the rising edge of the clock.

- c. 270° clock. Data transitions in the middle of clock high. Data is valid in the middle of clock low.
- d. Double-data rate clock. Also known as half clock. Data transitions in the middle of both clock high and low. Data is valid on both rising and falling edge of clock.

### 4.3 Fixed Formats

Characteristics of fixed formats are described below. Fixed formats do not have changes during transmission with regard to frame structure, word length or location, commutation sequence, sample interval, or measurement list.

#### 4.3.1 Word-Oriented Definitions and Requirements

The following definitions and requirements are addressed to word characteristics.

- a. Word Length (Class I and II). Individual words may vary in length from 4 bits to not more than 32 bits in Class I and not more than 64 bits in Class II.
- b. Fragmented Words (Class I and II). A fragmented word is defined as a word divided into no more than eight segments and placed in various locations within a minor frame. Locations need not be adjacent. For Class I, all word segments used to form a data word shall be constrained to the boundaries of a single minor frame. Class II may fragment across minor frames, though this is not recommended. Fragmented synchronization words are not allowed.
- c. Bit Numbering. To provide consistent notation, the most significant bit (msb) in a word shall be numbered “one”. Less significant bits shall be numbered sequentially within the word.
- d. Word Numbering. To provide consistent notation, the minor frame synchronization pattern word shall be numbered “zero” and the first word after the minor frame synchronization pattern shall be numbered “one” (see [Figure 4-3](#)). Each subsequent word shall be sequentially numbered within the minor frame. Numbering within a subframe (see Subsection [4.3.2](#) item [c\(1\)](#)) shall be “one” for the word in the same minor frame as the initial counter value for subframe synchronization and sequentially thereafter. Notations of W and S shall mean the W word position in the minor frame and S word position in the subframe.

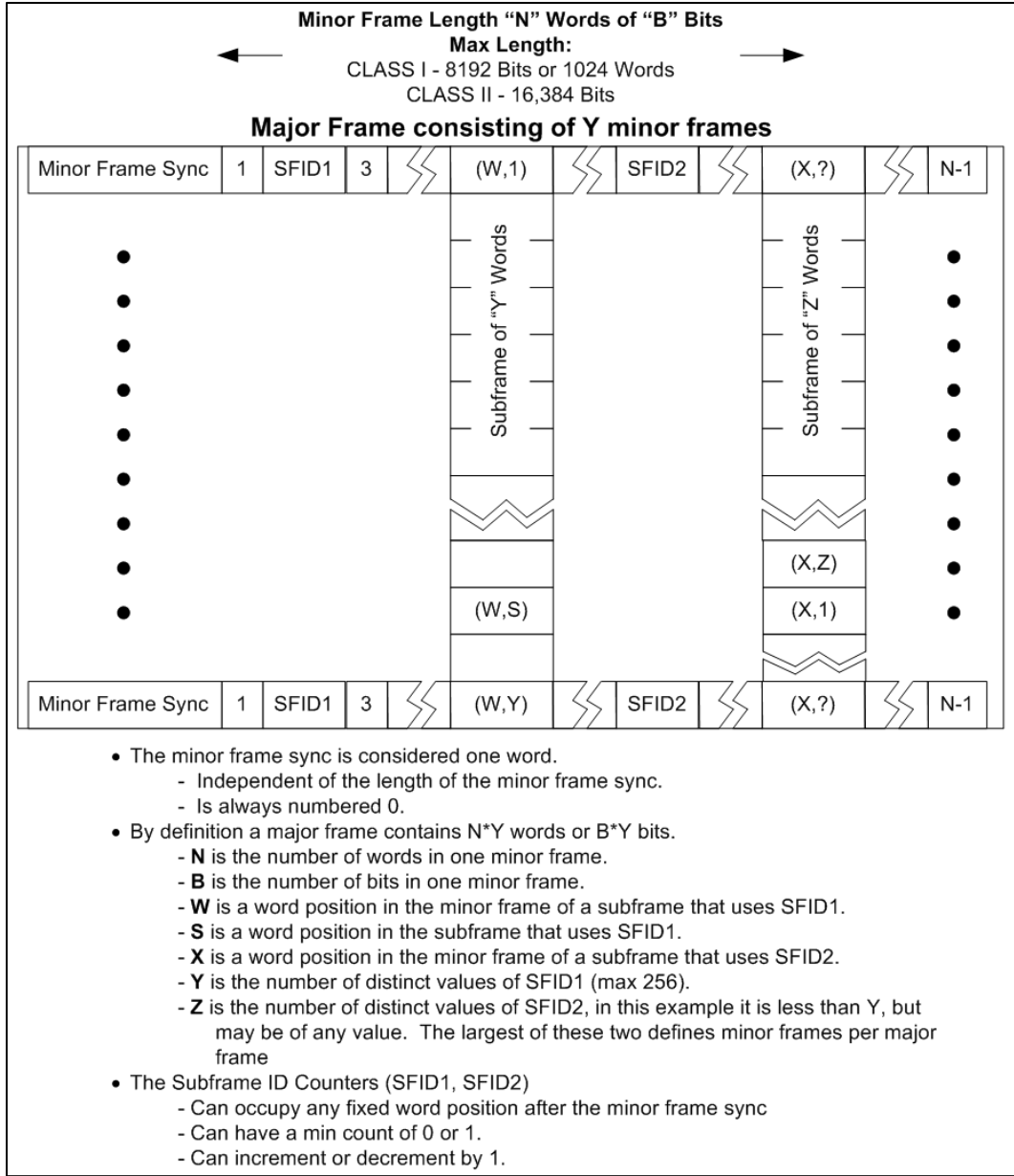

Figure 4-3. PCM Frame Structure

4.3.2 Frame Structure

The PCM data shall be formatted into fixed length frames as defined in these sections regarding frame structure and in [Figure 4-3](#). Frames shall contain a fixed number of equal duration bit intervals.

- a. Minor Frame. The minor frame is defined as the data structure in time sequence from the beginning of a minor frame synchronization pattern to the beginning of the next minor frame synchronization pattern. Certain Class II PCM systems may insert a variable number of fill bits between the end of one minor frame and the synchronization pattern of the next minor frame. When this is done, these filler bits are not considered to be a part of either minor frame.



- (1) Minor Frame Length (Class I and II). The minor frame length is the number of bit intervals from the beginning of the frame synchronization pattern to the beginning of the next synchronization pattern. The maximum length of a minor frame shall exceed neither 8192 bits nor 1024 words in Class I and shall not exceed 16384 bits in Class II. If fill bits are inserted, they are not to be used in the calculation of the minor frame length.
  - (2) Minor Frame Composition. The minor frame shall contain the minor frame synchronization pattern, data words, and subframe synchronization words, if used. Words of different length may be multiplexed in a single minor frame. The length of a word in any identified word position within a minor frame shall be constant. Other words such as frame format identifiers (FFIs) may be needed within Class II formats (see Section 4.4).
  - (3) Minor Frame Synchronization. The minor frame synchronization information shall consist of a fixed digital word not longer than 33 consecutive bits and not shorter than 16 bits. The minor frame synchronization pattern is always considered as one word, regardless of its length. Recommended synchronization patterns are given in [Table A-1](#). Class II formats may use an alternating complement synchronization pattern that complements after each minor frame.
  - (4) Transmitted Frame Counter. The frame counter provides a natural binary count corresponding to the minor frame number in which the frame count word appears. It is recommended that such a counter be included in all minor frames whether Class I or Class II and is especially desirable in Class II formats to assist with data processing. The frame counter should be of nominal format word length and reset to start up-counting again after reaching maximum value. In formats where subcommutation is present, the subframe identifier (SFID) counter may serve as the frame counter.
  - (5) Bit Numbering in a Minor Frame. To provide consistent notation, the first bit in a minor frame (the first bit in the sync pattern) shall be numbered “one”. Each subsequent bit shall be sequentially numbered within the minor frame. This is used for CRC.
- b. Major Frame. A major frame contains the number of minor frames required to include one occurrence of every word in the format. See [Figure 4-3](#).
- (1) Major Frame Length. Major frame length is defined as minor frame length (N words or B bits) multiplied by the number of minor frames (Z) in the major frame. The maximum number of minor frames per major frame shall not exceed 256.
  - (2) Minor Frame Numbering. To provide consistent notation, the first minor frame in a major frame shall be numbered “one”. Each subsequent minor frame shall be numbered sequentially within the major frame.
- c. Subcommutation. Subcommutation is defined as a sampling of parameters at submultiple rates (1/D) of the minor frame rate where the depth of a subframe, D, is an integer in the range of 2 to Z.

- (1) Subframe. Subframe is defined as one cycle of the parameters from a subcommutated minor frame word position. The depth, D, of a subframe is the number of minor frames in one cycle before repetition.
  - (2) Subframe Synchronization Method. The standard method for subframe synchronization is to use a SFID counter, a binary counter that counts sequentially up or down at the minor frame rate. Typically, only one SFID counter is used in a PCM format; however, more than one counter may be used if needed. This paragraph assumes the use of one SFID counter. The SFID counter shall be located in a fixed position in each and every minor frame. The counter should start with the minimum counter value when counting up or the maximum counter value when counting down. The counter should also be left or right justified in a word position. The start of a major frame shall coincide with the initial count for the deepest subframe.
  - (3) SFID Counter Location. The SFID counter should be placed in the minor frame prior to any subcommutated parameters. Subcommutated parameters that occur in the minor frame prior to the SFID counter are undefined.
- d. Supercommutation. Supercommutation is defined as time-division-multiplex sampling at a rate that is a multiple of the minor frame rate. Supercommutation (on a minor frame) provides multiple samples of the same parameter in each minor frame. *Supercommutation on a subframe* is defined as time-division-multiplex sampling at a rate that is a multiple of the subframe rate and provides multiple samples of the same parameter within a subframe. For Class I, supercommutated samples shall be evenly spaced. For Class II, supercommutated samples should be as evenly spaced as practical.

#### 4.3.3 Cyclic Redundancy Check (Class II)

A CRC is an error-detecting code commonly used in digital networks and storage devices. It can detect strings of bit errors that are of the length of the CRC check word. If a CRC check word is to be used, it should be inserted at the end of each minor frame and occupy the same location in each minor frame. It shall not occupy any bits from the frame sync pattern. It shall occupy contiguous bits, but may cross word boundaries. The CRC check word shall always be inserted msb first.

The CRC shall be calculated in bit-transmit order. The maximum length of bits to be checked shall be the length of one minor frame, but the bits being checked may span two minor frames. Minor frame fill bits shall not be used as part of a CRC calculation. The CRC calculation shall not use pre-inversion, post-inversion, reversed bit ordering, unusual starting value, or final XOR. Since ground station software typically runs in a general purpose computer, the decoding of the CRC will usually be done in software. Therefore, only a subset of 16 and 32 bit CRCs shall be supported. The supported CRC polynomials are as follows:

CRC-16-ANSI:  $x^{16} + x^{15} + x^2 + 1$   
 CRC-16-CCITT:  $x^{16} + x^{12} + x^5 + 1$   
 CRC-32:  $x^{32} + x^{26} + x^{23} + x^{22} + x^{16} + x^{12} + x^{11} + x^{10} + x^8 + x^7 + x^5 + x^4 + x^2 + x + 1$

#### 4.4 Format Change (Class II)

Format change is defined as change with regard to frame structure, word length or location, commutation sequence, sample interval, or change in measurement list. Format changes shall occur only on minor frame boundaries. Bit synchronization shall be maintained and fill bits used instead of intentional dead periods. Format changes are inherently disruptive to test data processing; fixed format methods are preferred. Format change methods shall conform to the characteristics described in the following sections.

##### 4.4.1 Frame Format Identification

An FFI is a word that shall uniquely identify a single format. In formats where change is required, the FFI shall be placed in every minor frame. The format identifier shall be the same length as (or multiples of) the most common word length in the format and shall occur in a fixed position in the minor frame. The FFI shall identify the format applicable to the current minor frame. Frame synchronization pattern, FFI location, bit rate, and binary bit representation code shall not be changed. The FFI shall be constructed such that a single bit error cannot produce another valid FFI. The number of unique formats indicated shall not exceed 16.

##### 4.4.2 Format Change Implementation Methods

The following subparagraphs describe format change implementation methods.

- a. Measurement List Change. This method of format change consists of a modification in data content only and not format structure.
- b. Format Structure Change. Defined as a format change where there is a departure in frame structure and not just data content.

#### 4.5 Asynchronous Embedded Format (Class II)

An asynchronous embedded format is defined as a secondary data stream asynchronously embedded into a host major frame in a manner that does not allow predicting the location of embedded synchronization information based only on host format timing. It is recommended that the embedded frame segments be inserted as an integral number of words in every host minor frame, so that in the combined format, specific word positions in the host minor frame are dedicated to the embedded asynchronous format; however, placing the asynchronous embedded format only in selected host minor frames is permitted. It is also recommended that no more than two asynchronous embedded formats be inserted in a host major frame, but more than two are permitted.

#### 4.6 Tagged Data Format (Class II)

A tagged data format is defined as a fixed frame length format having no applicable subframe or major frame definitions and characterized as a stream of data words, or blocks of words, with associated identifiers (tags). These formats consist of frame synchronization patterns, identifiers, data words, and fill words as required.

##### 4.6.1 Alternating Tag and Data

This tagged data format consists of frames containing tag words alternating in time sequence with data words or blocks of words identified by the tags.

4.6.2 Bus Data, MIL-STD 1553

The preferred method of telemetering MIL-STD 1553 information is for the information to be restructured to conform to Class I methods. If not restructured, telemetered MIL-STD 1553 data shall conform to [Chapter 8](#). This data format is described in Military Standard 1553<sup>2</sup>.

4.6.3 Bus Data, ARINC 429

The preferred method of telemetering ARINC information is for the information to be restructured to conform to Class I methods. If not restructured, telemetered ARINC 429 data shall be consistent with the specification of ARINC 429 bus data, as implemented in [Chapter 8](#). This data format is described in Aeronautical Radio, Inc. 429<sup>3</sup>.

**4.7 Time Words**

The following paragraphs describe the formatting of time words within a PCM stream. A 16-bit standardized time word format and a method to insert time words into PCM word sizes other than 16-bits are described.

In 16-bit standardized time word format, there shall be three words dedicated to providing timing information. These words are designated high order time, low order time, and microsecond time. High and low order time words shall be binary or binary coded decimal (BCD) weighted, and microsecond words shall be binary weighted. Time word construction examples are shown in [Figure 4-4](#) and [Figure 4-5](#).

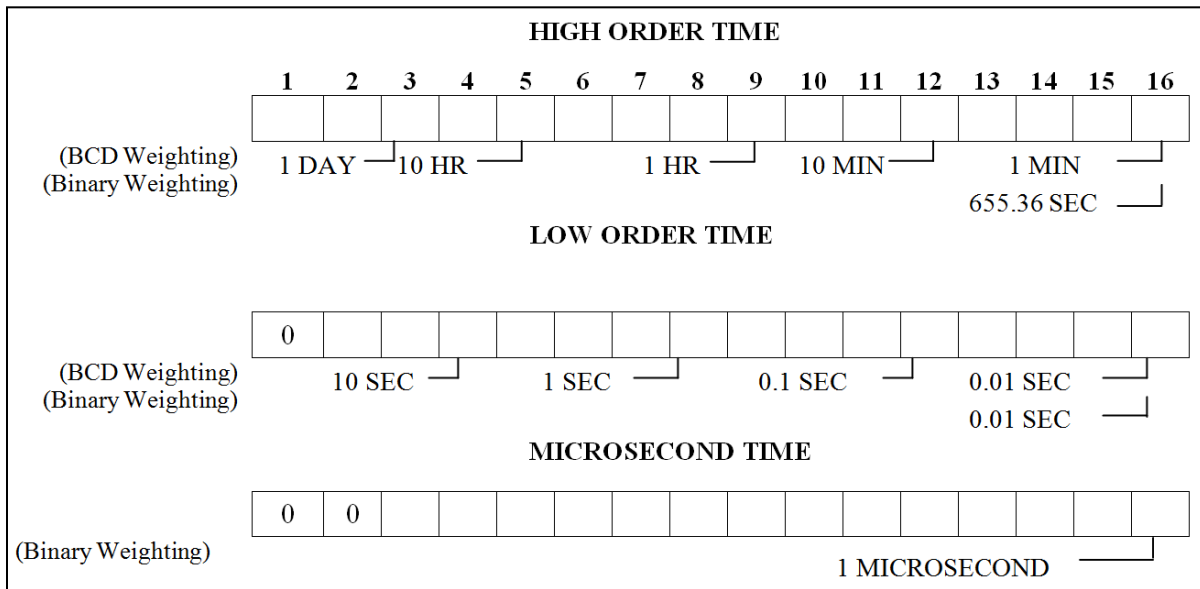

Figure 4-4. 16-Bit Standardized Time Word Format

<sup>2</sup> Department of Defense. *Aircraft Internal Time Division Command/Response Multiplex Data Bus*. MIL-STD-1553B. 21 September 1978. Superseded by update 28 February 2018. Retrieved 17 May 2021. Available at [https://quicksearch.dla.mil/basic\\_profile.cfm?ident\\_number=36973&method=basic](https://quicksearch.dla.mil/basic_profile.cfm?ident_number=36973&method=basic).

<sup>3</sup> Aeronautical Radio, Inc. *Mark 33 Digital Information Transfer System (DITS)*. ARINC 429. Annapolis: ARINC, 1995.

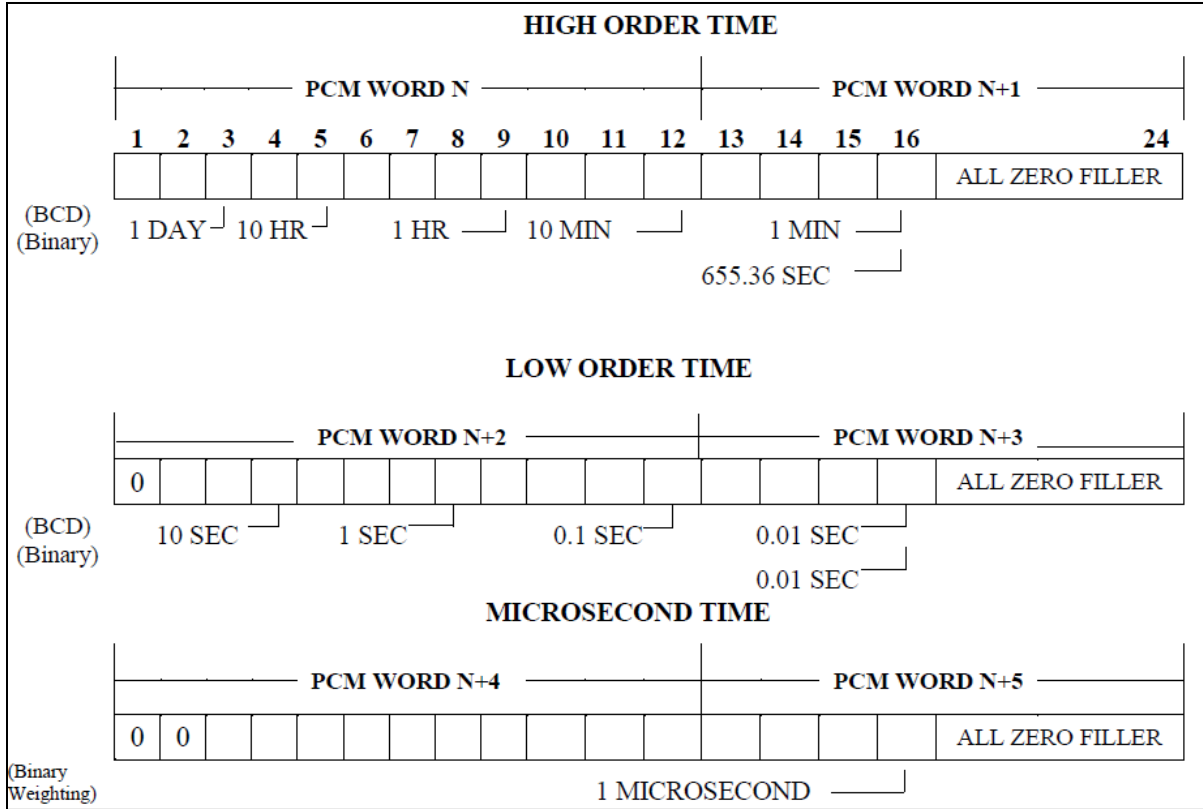

Figure 4-5. Time Word Insertion into 12-Bit PCM Word Size

The microsecond time word shall have a resolution of 1 microsecond; that is, the least significant bit (lsb), bit 16, has a value of 0.000001 second. This word shall increment until it attains a value of 10 milliseconds at which time it will reset to zero. Thus the maximum value of the counter is 9999 (decimal).

The low order time word shall have a resolution of 10 milliseconds; that is, the lsb, bit 16, of the low order time word shall have a value of 0.01 second.

The high order time word shall have a resolution of 655.36 seconds when binary weighted; that is, the lsb, bit 16, has a value of 655.36 seconds. When BCD weighted, the lsb, bit 16, of the high order time word shall have a value of one minute. For BCD, the days field shall contain the three least significant bits of the BCD Julian date.

It is recommended that high, low, and microsecond time words precede the first data word in the minor frame. The time word order shall be high order time word, followed by low order time word, followed by microsecond time word. Microsecond time words may be used to tag individual data words, but care shall be taken that high order and low order time words be inserted at a rate necessary to resolve time ambiguities.

Time word insertion into PCM word sizes other than 16 bits shall be as follows: high order, low order, and microsecond time words shall be inserted into PCM words with time word bits occupying contiguous bit locations in the PCM word. The time word shall occupy contiguous PCM data words until the time word is contained in the PCM stream. If the time word size is not an integer multiple of the PCM word size and there are unused bits in the PCM word, the remaining unused bits in the last PCM word that contains the time word shall be fill

bits with value 0. [Figure 4-5](#) illustrates the insertion of time words into a PCM stream with word size of 12 bits.

#### 4.8 Asynchronous Data Merge (Class II)

Asynchronous data is defined as an external sequential data stream (consisting of data bits, associated overhead, and optional parity, all at an autonomous update rate) that is a candidate for insertion into a primary or “host” PCM format. Common examples are RS-232 serial and IEEE-488 parallel messages. This section does not apply to secondary PCM formats that are to be embedded as described in Paragraph [4.5](#). Merger shall comply with Subsection [4.2.2](#).

Each source of merged data shall use fixed word positions in the host format. It is recommended that the merged data be inserted as an integral number of words in every host minor frame, so that in the combined format, specific word positions in the host minor frame are dedicated to the merged data format; however, placing the merged data format only in selected host minor frames is permitted. It is also recommended that no more than two merged data formats be inserted in a host major frame, but more than two are permitted. The following conventions are recommended, but variations are allowed.

##### 4.8.1 PCM Data Word Format

[Figure 4-6](#) illustrates the host PCM format word containing a merged asynchronous data word and associated overhead, which is referred to as an *asynchronous word structure*. The data may be inserted in any length PCM word that will accommodate the required bits. Asynchronous data shall not be placed in fragmented words. Multiple host PCM format words, if used, shall be contiguous.

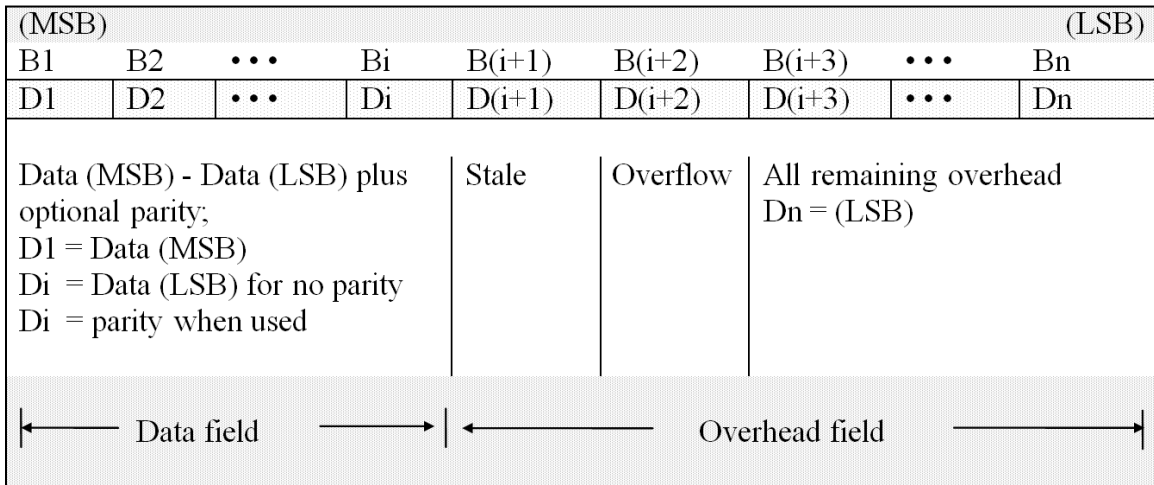

Figure 4-6. Asynchronous Word Structure

##### 4.8.2 Insertion Process

The asynchronous word structure shall contain the information from the asynchronous message partitioned into two fields, data and overhead, as shown in [Figure 4-6](#). The asynchronous message is inserted into the asynchronous word structure with the following bit orientations. The most significant data bit (msb) through least significant data bit (lsb) and parity

(if used) of the message are denoted as D1 (msb) through Di and will be inserted into structure bits B1 (msb) through Bi. The next two structure bits, B(i+1) and B(i+2) are reserved for the stale and overflow flags generated by the host encoder. All remaining overhead (message and host encoder generated) D(i+3) through Dn (lsb), will be inserted into structure bits B(i+3) through Bn (lsb).

- a. Transmission Overhead. All transmission overhead not required for data reconstruction shall be removed.
- b. Parity Bit. Transmission of a parity bit is optional. If it is transmitted, it shall be at the end of the data field (see [Figure 4-6](#)) adjacent to the lsb of the data.
- c. Data Bits. The data bits shall be inserted into the PCM word with the msb of the asynchronous data aligned with the msb of the PCM word.
- d. Stale Data Bit. A *stale data bit* flag shall be generated each time a new data value is inserted into the PCM stream. The flag shall be transmitted with the associated data. The flag bit shall be placed in the next less significant bit location following the lsb of the data. If new data is not ready for transmission by the time the PCM word must be sent again, either the old data or alternating one/zero fill shall be sent and the flag set. Stale data shall be indicated by a binary “one” (see [Table 4-1](#)).

<b>Table 4-1. Overhead Truth Table</b>		
<b>Stale Bit</b>	<b>Overflow Bit</b>	
0	0	Fresh Data
0	1	Data Overflow
1	0	Stale Data
1	1	User Defined

- e. Overflow Bit. An *overflow bit* flag shall be generated to indicate an abnormal condition in which data may be lost. The overflow bit shall be placed in the next less significant data bit location following the stale bit flag. An overflow bit at a binary “one” indicates that a data discontinuity exists between the current data word and the previous data word (see [Table 4-1](#) above).
- f. Insertion Rate. The asynchronous word structure shall be inserted into the host PCM word at a rate to avoid data loss in the PCM stream.

This page intentionally left blank.



## APPENDIX 4-A

### Additional Information and Recommendations

#### A.1. Bit Rate Versus Receiver Intermediate-Frequency Bandwidth

The following subparagraphs contain information about selection of receiver intermediate-frequency (IF) bandwidths. Additional information is contained in RCC document 119-06.

The standard receiver IF bandwidth values are listed in [Chapter 2](#), Table 2-1. Not all bandwidths are available on all receivers or at all test ranges. Additional bandwidths may be available at some test ranges. The IF bandwidth, for data receivers, should typically be selected so that 90 to 99 percent of the transmitted power spectrum is within the receiver 3-decibel (dB) bandwidth.

For reference purposes, in a well-designed PCM/frequency modulation (FM) system (NRZ-L data code) with peak deviation equal to 0.35 times the bit rate and an IF bandwidth (3 dB) equal to the bit rate, a receiver IF signal-to-noise ratio (SNR) of approximately 13 dB will result in a bit error probability (BEP) of  $10^{-6}$ . A 1-dB change in this SNR will result in approximately an order of magnitude change in the BEP. The relationship between BEP and IF SNR in a bandwidth equal to the bit rate is illustrated in [Figure A-1](#) for IF bandwidths equal to the bit rate and 1.5 times the bit rate. An approximate expression for the BEP is:

$$\text{BEP} = 0.5 e^{(k \cdot \text{SNR})} \quad \text{Eqn. A-1}$$

where:  $k \approx -0.7$  for IF bandwidth equal to bit rate

$k \approx -0.65$  for IF bandwidth equal to 1.2 times bit rate

$k \approx -0.55$  for IF bandwidth equal to 1.5 times bit rate

$\text{SNR} = \text{IF SNR} \cdot \text{IF bandwidth/bit rate}$ .

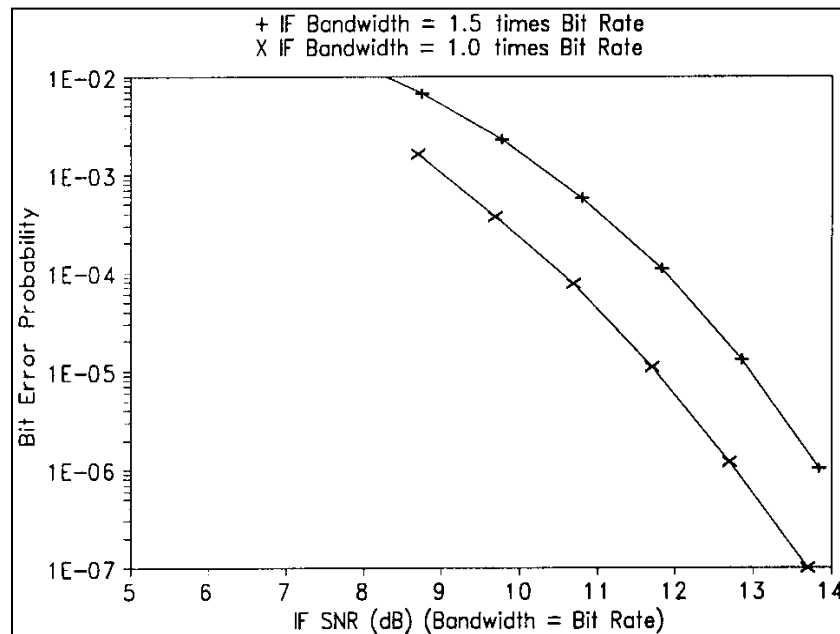

Figure A-1. BEP vs. IF SNR in Bandwidth = Bit Rate for NRZ-L PCM/FM

Other data codes and modulation techniques have different BEP versus SNR performance characteristics.

It is recommended that the maximum period between bit transitions be 64-bit intervals to ensure adequate bit synchronization.

## A.2. Recommended PCM Synchronization Patterns

[Table A-1](#) contains recommended frame synchronization patterns for general use in PCM telemetry. Patterns are shown in the preferred order of transmission with “111” being the first bit sequence transmitted. This order is independent of data being least-significant-bit or most-significant-bit aligned. The technique used in the determination of the patterns for lengths 16 through 30 was essentially that of the patterns of  $2^n$  binary patterns off a given length, n, for that pattern with the smallest total probability of false synchronization over the entire pattern overlap portion of the ground station frame synchronization.<sup>4</sup> The patterns for lengths 31 through 33 were obtained from a second source.<sup>5</sup>

<u>Pattern Length</u>	<u>Patterns</u>										
16	111	010	111	001	000	0					
17	111	100	110	101	000	00					
18	111	100	110	101	000	000					
19	111	110	011	001	010	000	0				
20	111	011	011	110	001	000	00				
21	111	011	101	001	011	000	000				
22	111	100	110	110	101	000	000	0			
23	111	101	011	100	110	100	000	00			
24	111	110	101	111	001	100	100	000			
25	111	110	010	110	111	000	100	000	0		
26	111	110	100	110	101	100	110	000	00		
27	111	110	101	101	001	100	110	000	000		
28	111	101	011	110	010	110	011	000	000	0	
29	111	101	011	110	011	001	101	000	000	00	
30	111	110	101	111	001	100	110	100	000	000	
31	111	111	100	110	111	110	101	000	010	000	0
32	111	111	100	110	101	100	101	000	010	000	00
33	111	110	111	010	011	101	001	010	010	011	000

<sup>4</sup> A more detailed account of this investigation can be found in a paper by J. L. Maury, Jr. and J. Styles, “Development of Optimum Frame Synchronization Codes for Goddard Space Flight Center PCM Telemetry Standards.” In *Proceedings of the National Telemetry Conference*, June 1964.

<sup>5</sup> The recommended synchronization patterns for lengths 31 through 33 are discussed more fully in a paper by E. R. Hill, “Techniques for Synchronizing Pulse-Code Modulated Telemetry.” In *Proceedings of the National Telemetry Conference*, May 1963.

### A.3. Spectral and BEP Comparisons for NRZ and Bi-phase<sup>6</sup>

[Figure A-2](#) shows the power spectral densities of baseband NRZ and Bi $\phi$  codes with random data. These curves were calculated using the equations presented below. [Figure A-3](#) presents the theoretical BEPs versus SNR for the level, mark, and space versions of baseband NRZ and Bi $\phi$  codes and also for RNRZ-L. The noise is assumed to be additive white Gaussian noise.

$$\text{NRZ SPECTRAL DENSITY} \propto \frac{\sin^2(\pi fT)}{(\pi fT)^2} \quad \text{Eqn. A-2}$$

$$\text{Bi}\phi \text{ SPECTRAL DENSITY} \propto \frac{\sin^4(\pi fT/2)}{(\pi fT/2)^2} \quad \text{Eqn. A-3}$$

where  $T$  is the bit period.

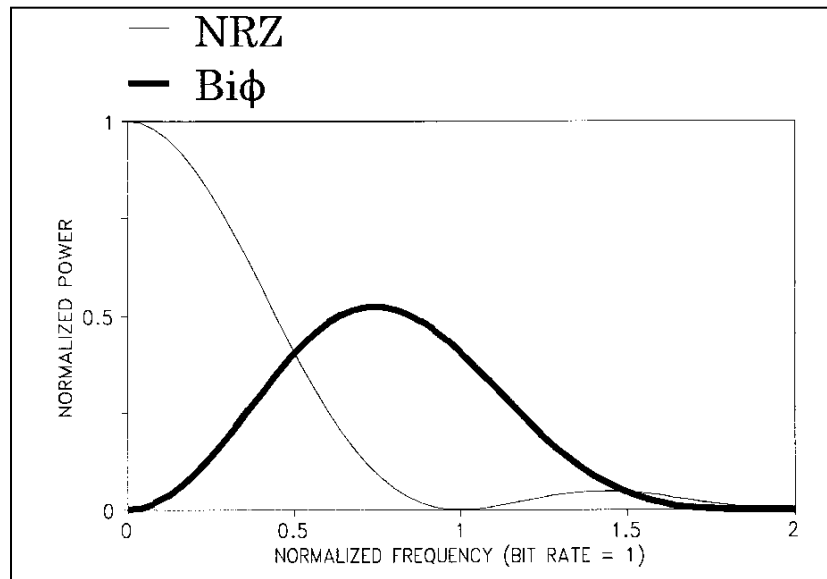

Figure A-2. Spectral Densities of Random NRZ and Bi $\phi$  Codes

<sup>6</sup> Material presented in paragraph 3.0 is taken from a study by W. C. Lindsey (University of Southern California), *Bit Synchronization System Performance Characterization, Modeling and Tradeoff Study*. AD0766794. Naval Missile Center Technical Publication. 4 September 1973. Retrieved 17 May 2021. Available at <https://apps.dtic.mil/sti/pdfs/AD0766794.pdf>.

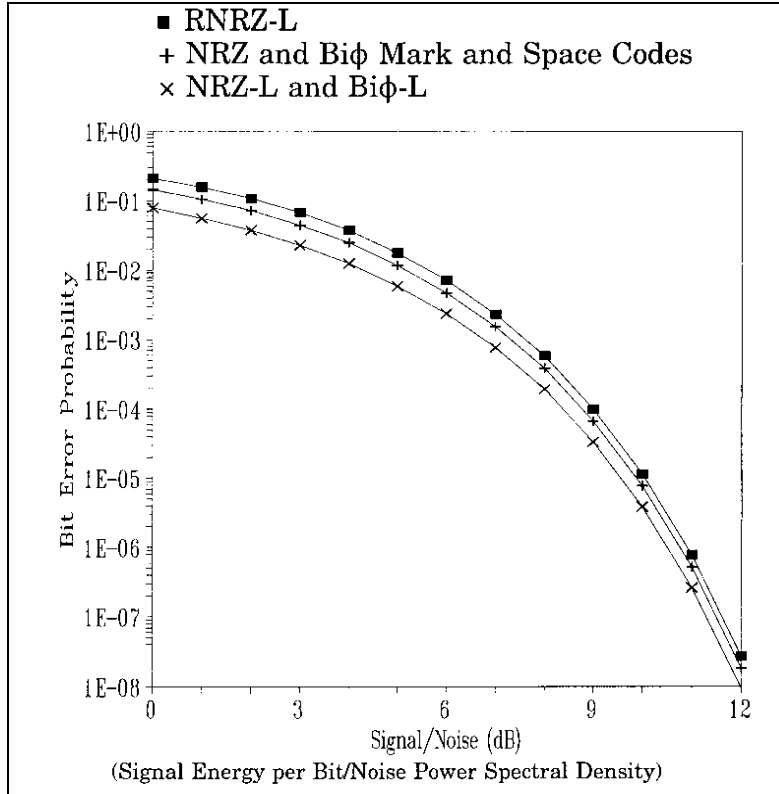

Figure A-3. Theoretical BEP Performance for Various Baseband PCM Signaling Techniques (Perfect Bit Synchronization Assumed)

#### A.4. PCM Frame Structure Examples

[Table A-2](#), [Table A-3](#), and [Table A-4](#) show examples of allowable PCM frame structures. In each example, the minor frame sync pattern is counted as one word in the minor frame. The first word after the minor frame sync pattern is word 1. [Table A-3](#) and [Table A-4](#) show the preferred method of placing the SFID counter in the minor frame. The counter is placed before the parameters that are referenced to it.

Major frame length is as follows:

- [Table A-2](#): Major frame length = minor frame maximum length.
- [Table A-3](#): Major frame length = minor frame maximum length multiplied by Z.
- [Table A-4](#): Major frame length = minor frame maximum length multiplied by Z.

**Table A-2. Minor Frame Maximum Length, N Words or B Bits**

Class I: Shall not exceed 8192 bits nor exceed 1024 words Class II: 16 384 Bits															
	Word 1	Word 2	Word 3	Word 4	Word 5	Word 6	Word 7	Word 8	Word 9	Word 10	...	...	...	Word N-2	Word N-1
Minor Frame Sync Pattern	Param A0	Param A1	Param A2	Param A3	Param A4	Param A2	Param A5	Param A6	Param A2	Param A7	...	...	...	Param A2	Param A(X)
Parameters A0, A1, A3, A4, A5, A6, ... A(X) are sampled once each minor frame. Parameter A2 is supercommutated on the minor frame. The rate of A2 is equal to the number of samples multiplied by the minor frame rate.															

**Table A-3. Major Frame Length = Minor Frame Maximum Length Multiplied by Z**

Minor Frame Maximum Length, N Words or B Bits ← Class I shall not exceed 8192 bits nor exceed 1024 words. Class II: 16 384 bits. →													
	Word 1	Word 2	Word 3	Word 4	Word 5	Word 6	Word 7	Word 8	Word 9	Word 10	...	Word N-2	Word N-1
Minor frame sync pattern	SFID= 1	FFI	Param A2	Param B1	Param A4	Param A2	Param A5	Param A6	Param A2	Param C1	...	Param A2	Param A(X)
	SFID= 2			Param B2						Param C2			
	SFID= 3			Param B3						Param C3			
	SFID= 4			Param B4						Param C4			
	SFID= 5			Param B2						Param C5			
	SFID= 6			Param B5						Param C6			
	SFID= 7			Param B6						Param C7			
	.			.						.			
	.			.						.			
	.			Param B2						Param C(Z-1)			
Minor frame sync pattern	SFID =Z	FFI	Param A2	Param BZ	Param A4	Param A2	Param A5	Param A6	Param A2	Param CZ	...	Param A2	Param A(X)

The frame format identifier (word 2) is shown in the preferred position as the first word following the ID counter. Parameters B1, B3, B4, B5, . . . BZ, and C1, C2, C3, . . . CZ are sampled once each subframe, at 1/Z multiplied by the minor frame rate. Parameter B2 is supercommutated on the subframe and is sampled at less than the minor frame rate, but greater than the subframe rate.

**Table A-4. Major Frame Length = Minor Frame Maximum Length Multiplied by Z**

Minor Frame Maximum Length, N Words or B Bits													
← Class I shall not exceed 8192 bits or exceed 1024 words. Class II: 16 384 bits. →													
	Word 1	Word 2	Word 3	Word 4	Word 5	Word 6	Word 7	Word 8	Word 9	Word 10	...	Word N-2	Word N-1
Minor frame sync pattern	SFID1 =1	FFI	Param A2	SFID2 =1	Param B1	Param A2	Param A5	Param E1	Param A2	Param C1	...	Param A2	Param A(X)
	SFID1 =2			SFID2 =2	Param B2			Param E2		Param C2			
	SFID1 =3			SFID2 =3	Param B3			Param E3		Param C3			
	SFID1 =4			SFID2 =4	Param B4			Param E4		Param C4			
	SFID1 =5			SFID2 =5	Param B2			Param E5		Param C5			
	SFID1 =6			.	Param B5			.		Param C6			
	SFID1 =7			SFID2 =D	Param B6			Param ED		Param C7			
	.			.	.			.		.			
	.			.	Param B2			.		Param C(Z-1)			
Minor frame sync pattern	SFID1 =Z	FFI	Param A2	SFID2 =N	Param BZ	Param A2	Param A5	Param EN	Param A2	Param CZ	...	Param A2	Param A(X)

SFID1 and SFID2 and subframe counters.  
 SFID1 has a depth  $Z \leq 256$ ; SFID2 has a depth  $D < Z$ . Z divided by D is not an integer.  
 Location of the B and C parameters are given by the minor frame word number and the SFID1 counter.  
 Location of the E parameters are given by the minor frame word number and the SFID2 counter.

This page intentionally left blank.



## APPENDIX 4-B

### Citations

- Aeronautical Radio, Inc. *Mark 33 Digital Information Transfer System (DITS)*. ARINC 429. Annapolis: ARINC, 1995.
- Department of Defense. *Aircraft Internal Time Division Command/Response Multiplex Data Bus*. MIL-STD-1553B. 21 September 1978. Superseded by update 28 February 2018. Retrieved 17 May 2021. Available at [https://quicksearch.dla.mil/qsDocDetails.aspx?ident\\_number=36973](https://quicksearch.dla.mil/qsDocDetails.aspx?ident_number=36973).
- E. R. Hill. "Techniques for Synchronizing Pulse-Code Modulated Telemetry" in *Proceedings of the National Telemetry Conference*, May 1963.
- J. L. Maury, Jr. and J. Styles. "Development of Optimum Frame Synchronization Codes for Goddard Space Flight Center PCM Telemetry Standards." In *Proceedings of the National Telemetry Conference*, June 1964.
- Range Commanders Council. *Telemetry Applications Handbook*. RCC 119-06. May 2006. May be superseded by update. Retrieved 17 May 2021. Available at <https://www.trmc.osd.mil/wiki/x/h4u8Bg>.
- W. C. Lindsey. *Bit Synchronization System Performance Characterization, Modeling and Tradeoff Study*. AD0766794. Naval Missile Center Technical Publication. 4 September 1973. Retrieved 17 May 2021. Available at <https://apps.dtic.mil/sti/pdfs/AD0766794.pdf>.

**\*\*\*\* END OF CHAPTER 4 \*\*\*\***

## CHAPTER 5

### Digitized Audio Telemetry Standard

<b>Acronyms</b> .....	<b>5-iii</b>
<b>Chapter 5. Digitized Audio Telemetry Standard</b> .....	<b>5-1</b>
<b>5.1 General</b> .....	<b>5-1</b>
<b>5.2 Definitions</b> .....	<b>5-1</b>
<b>5.3 Signal Source</b> .....	<b>5-1</b>
<b>5.4 Encoding/Decoding Technique</b> .....	<b>5-1</b>
<b>5.5 CVSD Encoder Output Bit Rate (CVSD Bit Rate)</b> .....	<b>5-2</b>
<b>5.6 CVSD Word Structure</b> .....	<b>5-2</b>
<b>5.7 CVSD Word Sample Rate</b> .....	<b>5-2</b>
<b>5.8 CVSD Bit Rate Determination</b> .....	<b>5-3</b>
<b>Appendix 5-A. Continuously Variable Slope Delta Modulation</b> .....	<b>A-1</b>
<b>A.1. General</b> .....	<b>A-1</b>
<b>A.2. General Descriptions</b> .....	<b>A-1</b>
A.2.a. Delta Modulation .....	A-1
A.2.b. CVSD Converter .....	A-2
<b>A.3. Detailed Descriptions</b> .....	<b>A-2</b>
A.3.a. Input Band Pass Filter .....	A-3
A.3.b. Comparator .....	A-3
A.3.c. 3-Bit Shift Register .....	A-3
A.3.d. Overload Algorithm .....	A-3
A.3.e. Syllabic Filter.....	A-3
A.3.f. Pulse Amplitude Modulator .....	A-3
A.3.g. Reconstruction Integrator.....	A-4
A.3.h. Output Low-Pass Filter .....	A-4
A.3.i. Typical CVSD Decoder Output Envelope Characteristics .....	A-4
<b>A.4. Reference Level</b> .....	<b>A-5</b>
<b>A.5. CVSD Characteristics</b> .....	<b>A-5</b>
A.5.a. Input and Output Impedances .....	A-5
A.5.b. Data Signaling Rates.....	A-5
A.5.c. Input and Output Filters .....	A-5
A.5.d. Overload Algorithm .....	A-5
A.5.e. Compression Ratio.....	A-5
A.5.f. Syllabic Filter .....	A-5
A.5.g. Reconstruction Integrator Time Constant .....	A-5
A.5.h. Analog-to-Digital Conversion .....	A-6

A.5.i. Digital-to-Analog Conversion ..... A-6  
A.5.j. CVSD Converter Performance ..... A-6  
**Appendix 5-B. Citations ..... B-1**

**List of Figures**

Figure 5-1. Insertion of CVSD-Encoded Audio into a PCM Stream ..... 5-2  
Figure A-1. Typical CVSD Encoder ..... A-1  
Figure A-2. Typical CVSD Decoder ..... A-1  
Figure A-3. Typical Envelope Characteristics of the Decoder Output Signal for CVSD ..... A-4  
Figure A-4. Interface Diagram for CVSD Converter ..... A-6  
Figure A-5. Insertion Loss vs. Frequency for CVSD (16 kbps)..... A-8  
Figure A-6. Insertion Loss vs. Frequency for CVSD (32 kbps)..... A-8  
Figure A-7. Variation of Gain with Input Level for CVSD (16 kbps) ..... A-9  
Figure A-8. Variation of Gain With Input Level for CVSD (32 kbps) ..... A-9  
Figure A-9. Signal to Quantizing Noise Ratio vs. Input Level for CVSD (16 kbps)..... A-10  
Figure A-10. Signal to Quantizing Noise Ratio vs. Input Level for CVSD (32 kbps)..... A-10  
Figure A-11. Signal to Quantizing Noise Ratio vs. Frequency for CVSD (16 Kbps)..... A-11  
Figure A-12. Signal to Quantizing Noise Ratio vs. Frequency for CVSD (32 Kbps)..... A-11

## Acronyms

CVSD	continuously variable slope delta
dB	decibel
Hz	hertz
kbps	kilobit per second
lsb	least significant bit
ms	millisecond
msb	most significant bit
PAM	pulse amplitude modulator
PCM	pulse code modulation

This page intentionally left blank.

## CHAPTER 5

### Digitized Audio Telemetry Standard

#### 5.1 General

This chapter defines continuously variable slope delta (CVSD) modulation as the standard for digitizing audio and addresses the method of inserting CVSD encoded audio into a pulse code modulation (PCM) stream. Additional information and recommendations are provided in [Appendix 5-A](#), which was extracted from the applicable sections of Military Standard 188-113, which has been canceled with no replacement.

Additional information regarding the insertion of the digitized voice signal into a PCM frame may be obtained in the documentation of US Patent 5,557,635.<sup>1</sup>

#### 5.2 Definitions

For the purpose of this standard, the following definitions apply.

**Band-Limited Audio:** An audio signal (typically consisting of voice, tones, and sounds) that is limited to a subset of the audio spectrum. For most aircraft audio applications, the spectrum between 100 and 2300 hertz (Hz) is adequate.

**Continuously Variable Slope Delta Modulation:** The CVSD modulation is a method of digitizing a band-limited audio signal. The CVSD modulator is, in essence, a 1-bit analog-to-digital converter. The output of this 1-bit encoder is a serial bit stream, where each bit represents an incremental increase or decrease in signal amplitude and is determined as a function of recent sample history.

#### 5.3 Signal Source

The signal to be encoded shall be a band-limited audio signal. The source of this signal may be varied. Some examples are microphones, communication systems, and tones from warning systems. This standard applies to audio signals only.

#### 5.4 Encoding/Decoding Technique

The technique to encode and decode the band-limited audio signal is CVSD modulation. This technique is to be implemented in accordance with [Appendix 5-A](#).

A CVSD converter consists of an encoder-decoder pair. The decoder is connected in a feedback path. The encoder receives a band-limited audio signal and compares it to the analog output of the decoder. The result of the comparison is a serial string of “ones” and “zeros.” Each bit indicates that the band-limited audio sample’s amplitude is above or below the decoded signal. When a run of three identical bits is encountered, the slope of the generated analog approximation is increased in its respective direction until the identical string of bits is broken. The CVSD decoder performs the inverse operation of the encoder and regenerates the audio signal.

---

<sup>1</sup> Daniel T. Laird. Voice encode/decode subsystem in a system for acquisition of test data using pulse code modulation. US Patent 5,557,635, filed September 28, 1994 and issued September 17, 1996.

 <p><b>NOTE</b></p>	<p>A qualitative test of CVSD with a tactical aircraft intercom system yielded the following results: (1) intelligible, robotic sounding audio at 12 kilobits per second (kbps); (2) good quality audio at 16 kbps; and (3) audio quality did not significantly improve as the bit rate was increased above 32 kbps.</p>
--	--

**5.5 CVSD Encoder Output Bit Rate (CVSD Bit Rate)**

The CVSD bit rate for encoding the band-limited audio signal is a function of the desired audio quality and the PCM format characteristics. The minimum and maximum CVSD bit rates will not be specified.

[Appendix 5-A](#) contains performance criteria for the CVSD encoder and decoder when operated at 16 or 32 kbps.

**5.6 CVSD Word Structure**

The digitized audio signal from the CVSD encoder’s serial output shall be inserted into the PCM stream as shown in [Figure 5-1](#). The most significant bit (msb) shall be the most stale sample (first in). The least significant bit (lsb) shall be the most recent sample (last in).

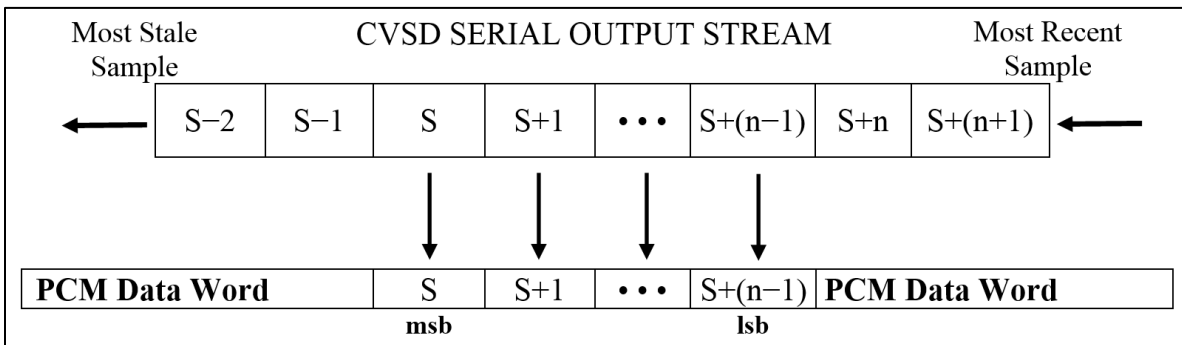



Figure 5-1. Insertion of CVSD-Encoded Audio into a PCM Stream

**5.7 CVSD Word Sample Rate**

The CVSD word sample rate is dependent on the minimum desired CVSD bit rate, the PCM word length, and the PCM word sample rate. Once the CVSD word sample rate is determined, the actual CVSD bit rate can be calculated. The decoder must be run at the same CVSD bit rate as the encoder.

 <p><b>NOTE</b></p>	<p>Because of the nature of CVSD encoding, over and under sampling of the CVSD output will have unpredictable results.</p>
--	--

 <p><b>NOTE</b></p>	<p>To simplify the reconstruction of the audio signal and minimize all encoding/decoding delays, it is <b>STRONGLY</b> recommended that the digitized audio words be inserted in the PCM stream at evenly spaced intervals.</p>
--	---



## 5.8 CVSD Bit Rate Determination

The following discussion provides a procedure for determining the CVSD bit rate based on the desired minimum CVSD bit rate and information given in the host PCM format. Note that this procedure assumes the CVSD words are inserted in a class I PCM format with constant word widths and are not subcommutated. The CVSD bit rate can be obtained by multiplying the minor frame rate by the number of times the CVSD words appear in the minor frame by the word width used for the CVSD words in the minor frame. This relationship is expressed in equation (5-1).

$$\text{CVSD Bit Rate} = \text{Minor Frame Rate} \cdot \# \text{CVSD Words per Minor Frame} \cdot \text{Word Width} \quad (5-1)$$

Knowing the details on the host PCM format, equation (5-1) contains two unknowns: CVSD bit rate and #CVSD words per minor frame. One of these unknowns must be chosen by the user; then the other one can be calculated. The recommended procedure is to choose the desired (target value) CVSD bit rate and solve equation (5-1) for #CVSD words per minor frame. This relationship is expressed in equation (5-2).

$$\# \text{CVSD WORDS PER MINOR FRAME}_{\text{CALCULATED}} = \frac{\text{DESIRED CVSD BIT RATE}}{\text{MINOR FRAME RATE} \cdot \text{WORD WIDTH}} \quad (5-2)$$

Next, round up (if required) the result of equation (5-2) to the nearest integer. To satisfy the evenly spaced recommendation, round up (if required) to the nearest integer that divides evenly into the number of PCM words per minor frame.

Finally, for either case, substitute the result of equation (5-2) back into equation (5-1) to determine the actual CVSD bit rate. To illustrate this procedure, consider the following numerical example for determining the CVSD bit rate. An existing PCM format has the characteristics:

Bit rate = 192,000 bits/second  
 Word width = 12 bits/word  
 Minor frame rate = 100 frames/second  
 Words/ minor frame = 160 words/minor frame

To insert a serial CVSD bit stream with a desired (target value), CVSD bit rate of 16,000 bits/second will require the following procedure. Based on the information given, use equation (5-2) to calculate the #CVSD words per minor frame.

$$\# \text{CVSD WORDS PER MINOR FRAME}_{\text{CALCULATED}} = \frac{\text{DESIRED CVSD BIT RATE}}{\text{MINOR FRAME RATE} \cdot \text{WORD WIDTH}}$$

$$\# \text{CVSD WORDS PER MINOR FRAME}_{\text{CALCULATED}} = \frac{16\,000 \text{ (bits/sec)}}{100 \text{ (frames/sec)} \cdot 12 \text{ (bits/word)}}$$

$$\# \text{CVSD WORDS PER MINOR FRAME}_{\text{CALCULATED}} = 13.3 \text{ words/frame}$$

Rounding up the #CVSD words per minor frame to the nearest integer yields 14. In this example, there are 160 PCM words in the minor frame. If the user needs to satisfy the evenly spaced criteria, then by inspection, the #CVSD words per minor frame will be rounded up to 16. For comparison, both cases will be substituted into equation (5-1) to yield the actual CVSD bit rate.

CASE 1: (unevenly spaced CVSD samples, NOT RECOMMENDED)

$$\#CVSD \text{ WORDS PER MINOR FRAME}_{\text{CALCULATED}} = 14 \text{ (words/frame)}$$

$$CVSD \text{ BIT RATE} = \text{MINOR FRAME RATE} \cdot \#CVSD \text{ WORDS / MINOR FRAME} \cdot \text{WORD WIDTH}$$

$$CVSD \text{ BIT RATE}_{\text{ACTUAL}} = 100 \text{ (frames/sec)} \cdot 14 \text{ (words/frame)} \cdot 12 \text{ (bits/word)}$$

$$CVSD \text{ BIT RATE}_{\text{ACTUAL}} = 16\,800 \text{ (bits/sec)}$$

CASE 2: (evenly spaced samples, RECOMMENDED)

$$\#CVSD \text{ WORDS PER MINOR FRAME}_{\text{CALCULATED}} = 16 \text{ (words/frame)}$$

$$CVSD \text{ BIT RATE} = \text{MINOR FRAME RATE} \cdot \#CVSD \text{ WORDS PER MINOR FRAME} \cdot \text{WORD WIDTH}$$

$$CVSD \text{ BIT RATE}_{\text{ACTUAL}} = 100 \text{ (frames/sec)} \cdot 16 \text{ (words/frame)} \cdot 12 \text{ (bits/word)}$$

$$CVSD \text{ BIT RATE}_{\text{ACTUAL}} = 19\,200 \text{ (bits/sec)}$$

## APPENDIX 5-A

### Continuously Variable Slope Delta Modulation

#### A.1. General

The CVSD modulation is a nonlinear, sampled data, feedback system which accepts a band-limited analog signal and encodes it into binary form for transmission through a digital channel. At the receiver, the binary signal is decoded into a close approximation of the original analog signal. A typical CVSD converter consisting of an encoder and decoder is shown in [Figure A-1](#) and [Figure A-2](#).

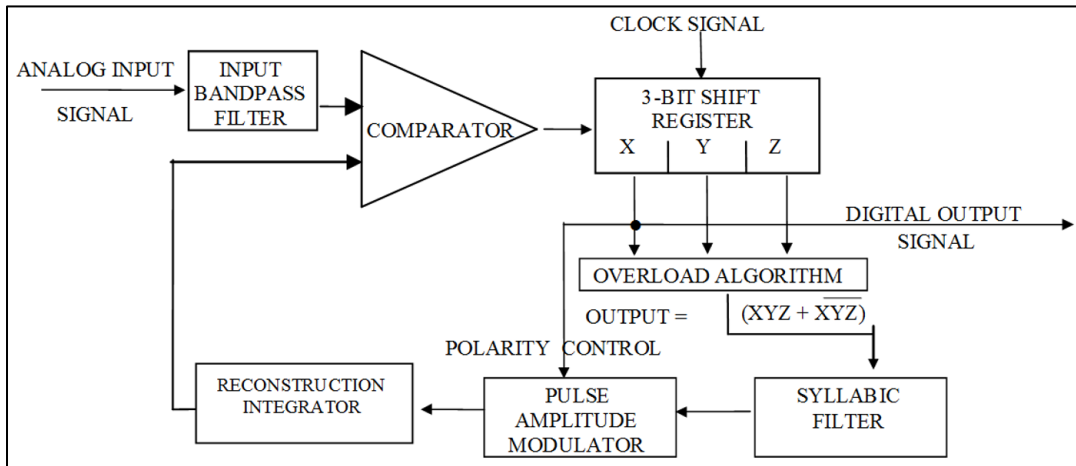

Figure A-1. Typical CVSD Encoder

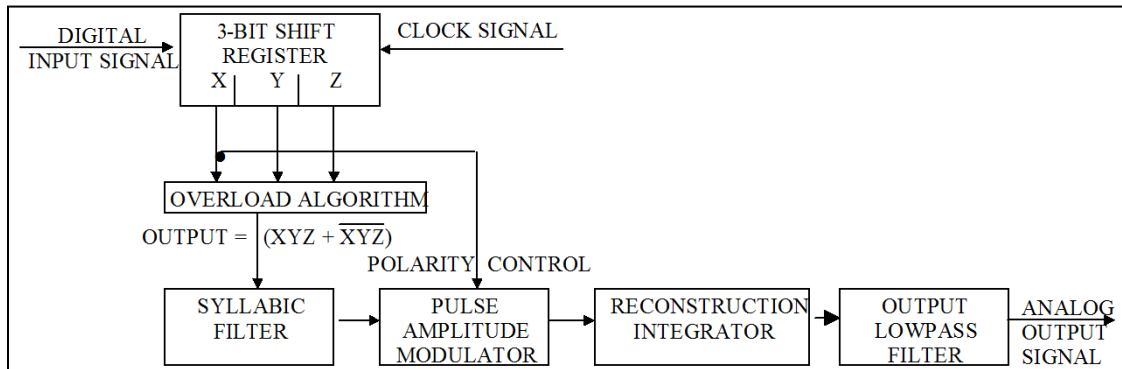

Figure A-2. Typical CVSD Decoder

#### A.2. General Descriptions

A general description of the delta modulation and the CVSD converter can be found in the following subparagraphs.

##### A.2.a. Delta Modulation

Delta modulation is an A-D conversion technique resulting in a form of digital pulse modulation. A delta modulator periodically samples the amplitude of a band-limited analog

signal, and the amplitude differences of two adjacent samples are coded into n-bit code words. This nonlinear, sampled-data feedback system then transmits the encoded bit stream through a digital channel. At the receiving end, an integrating network converts the delta-modulated bit stream through a decoding process into a close approximation of the original analog signal.

#### A.2.b. CVSD Converter

A typical CVSD converter consists of an encoder and a decoder (see [Figure A-1](#) and [Figure A-2](#)). The analog input signal of the CVSD encoder is band-limited by the input band, pass filter. The CVSD encoder compares the band-limited analog input signal with an analog feedback approximation signal generated at the reconstruction integrator output. The digital output signal of the encoder is the output of the first register in the “run-of-three” counter. The digital output signal is transmitted at the clock (sample) rate and will equal “1” if the analog input signal is greater than or equal to the analog feedback signal at the instant of sampling. For this value of the digital output signal, the pulse amplitude modulator (PAM) applies a positive feedback pulse to the reconstruction integrator; otherwise, a negative pulse is applied. This function is accomplished by the polarity control signal, which is equal to the digital encoder output signal. The amplitude of the feedback pulse is derived by means of a 3-bit shift register, logic sensing for overload, and a syllabic lowpass filter. When a string of three consecutive ones or zeros appears at the digital output, a discrete voltage level is applied to the syllabic filter, and the positive feedback pulse amplitude increases until the overload string is broken. In such an event, ground potential is fed to the filter by the overload algorithm, forcing a decrease in the amplitude of the slope voltage out of the syllabic filter. The encoder and decoder have identical characteristics except for the comparator and filter functions.

The CVSD decoder consists of the input band pass filter, shift register, overload algorithm, syllabic filter, PAM and reconstruction integrator used in the encoder, and an output low-pass filter. The decoder performs the inverse function of the encoder and regenerates speech by passing the analog output signal of the reconstruction integrator through the low-pass filter. Other characteristics optimize the CVSD modulation technique for voice signals. These characteristics include the following.

- a. Changes in the slope of the analog input signal determine the step-size changes of the digital output signal.
- b. The feedback loop is adaptive to the extent that the loop provides continuous or smoothly incremental changes in step size.
- c. Companding is performed at a syllabic rate to extend the dynamic range of the analog input signal.
- d. The reconstruction integrator is of the exponential (leaky) type to reduce the effects of digital errors.

### A.3. **Detailed Descriptions**

The characteristics described in subparagraphs [A.3.a](#) through [A.3.i](#) are in addition to those specified in Section [A.5](#) and are for guidance only.

#### A.3.a. Input Band Pass Filter

The input filter provides band-limiting and is typically a second- or higher-order filter (see [Figure A-1](#)).

#### A.3.b. Comparator

The comparator compares the band-limited analog input signal from the filter with the output signal of the reconstruction integrator (see [Figure A-1](#)). This comparison produces the digital error signal input to the 3-bit shift register. The transfer characteristic of the comparator is such that the difference between the two input signals causes the output signal to be driven to saturation in the direction of the sign of the difference.

#### A.3.c. 3-Bit Shift Register

The 3-bit shift register acts as a sampler which clocks the digital error signal from the comparator at the specified data signaling rate and stores the current samples and two previous samples of the error signal (see [Figure A-1](#) and [Figure A-2](#)). The digital output signal is a binary signal having the same polarity as the input signal from the comparator at the time of the clock signal. The digital output signal is also the digital output of the encoder and is referred to as the baseband signal. Further processing for transmission such as conditioned diphase modulation may be applied to the baseband signal. It is necessary that the inverse of any such processing be accomplished and the baseband signal restored before the CVSD decoding process is attempted.

#### A.3.d. Overload Algorithm

The overload algorithm operates on the output of the 3-bit shift register (X, Y, Z) using the run-of-threes coincidence algorithm so that the algorithm output equals  $(XYZ + \overline{XYZ})$  (see [Figure A-1](#) and [Figure A-2](#)). The output signal is a binary signal at the clock signaling rate and is true for one clock period following the detection of three like bits and false at all other times.

#### A.3.e. Syllabic Filter

The syllabic filter acts as a low-pass filter for the output signal from the overload algorithm (see [Figure A-1](#) and [Figure A-2](#)). The slope-voltage output of the syllabic filter is the modulating input to the PAM. The step-function response of the syllabic filter is related to the syllabic rate of speech, is independent of the sampling rate, and is exponential in nature. When the overload algorithm output is true, a charging curve is applicable. When this output is false, a discharging curve is applicable.

#### A.3.f. Pulse Amplitude Modulator

The PAM operates with two input signals: the output signal from the syllabic filter and the digital signal from the 3-bit shift register (see [Figure A-1](#) and [Figure A-2](#)). The syllabic filter output signal determines the amplitude of the PAM output signal and the signal from the 3-bit shift register is the polarity control that determines the direction, plus or minus, of the PAM output signal. The phrase “continuously variable” in CVSD is derived from the way the PAM output signal varies almost continuously.

### A.3.g. Reconstruction Integrator

The reconstruction integrator operates on the output signal of the PAM to produce an analog feedback signal to the comparator (or an output signal to the output low-pass filter in the receiver) that is an approximation of the analog input signal (see [Figure A-1](#) and [Figure A-2](#)).

### A.3.h. Output Low-Pass Filter

The output filter is a low-pass filter having a frequency response that typically has an asymptotic rolloff with a minimum slope of 40 decibels (dB) per octave, and a stopband rejection that is 45 dB or greater (see [Figure A-2](#)). The same output filter characteristic is used for encoder digital output signals of either 16 or 32 kbps.

### A.3.i. Typical CVSD Decoder Output Envelope Characteristics

For a resistance/capacitance circuit in the syllabic filter with time constants of 5 milliseconds (ms) for both charging and discharging, the envelope characteristics of the signal at the decoder output are shown in [Figure A-3](#). For the case of switching the signal at the decoder input from the 0 percent run-of-threes digital pattern to the 30 percent run-of-threes digital pattern, the characteristic of the decoder output signal follows the resistance/capacitance charge curve. Note that the number of time constants required to reach the 90 percent charge point is 2.3, which gives a nominal charge time of 11.5 ms.

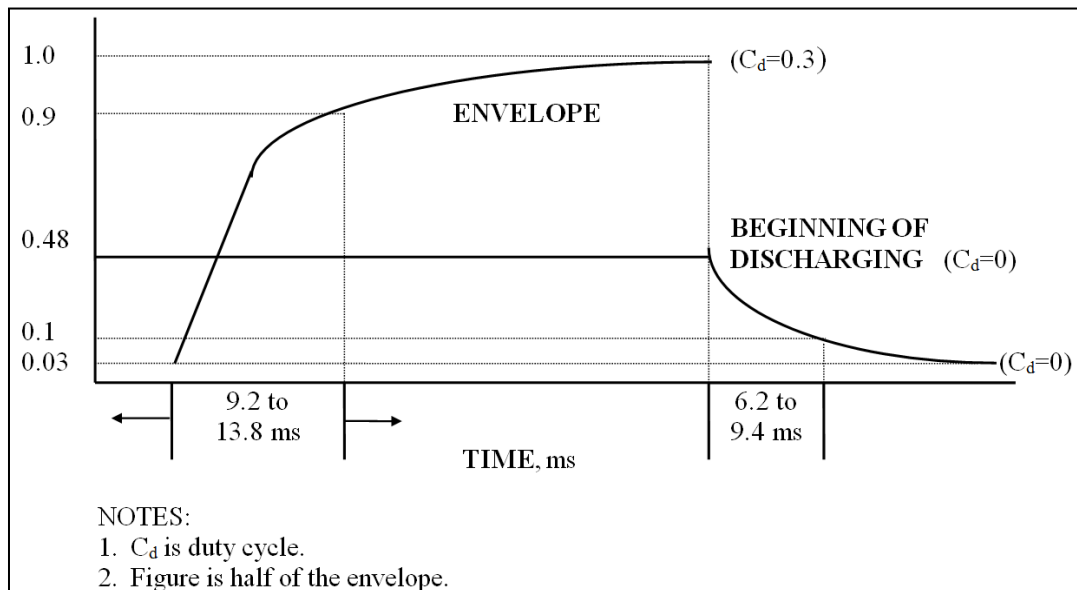

Figure A-3. Typical Envelope Characteristics of the Decoder Output Signal for CVSD

When switching the other way (from the 30 percent pattern to the 0 percent pattern), the amplitude at the beginning of discharging is, at the first moment of switching, higher (by a factor of 16) than the final value which is reached asymptotically. The final value equals  $-24$  dBm<sub>0</sub>, that is, 0.03. Therefore, the amplitude at the beginning of discharging is 0.48 (percent run-of-threes = 0). Note that the number of time constants required to reach the 10 percent point on the discharge curve is 1.57, which gives a nominal discharge time of 7.8 ms.

#### A.4. Reference Level

The decoder analog output level with the 16 and 32 kbps, 30 percent run-of-threes reference digital pattern applied to the decoder input shall be the reference level for the CVSD requirements of this standard and shall be designated 0 dBm0 (see Subparagraph [A.5.i\(1\)](#)).

#### A.5. CVSD Characteristics

The characteristics of CVSD are described in the following subparagraphs.

##### A.5.a. Input and Output Impedances

The analog input and output impedances for CVSD converters are not standardized. These impedances depend upon the application of the converters.

##### A.5.b. Data Signaling Rates

The CVSD converter shall be capable of operating at 16 and 32 kbps.

##### A.5.c. Input and Output Filters

The analog input shall be band pass filtered. The analog output shall be low pass filtered.

 <b>NOTE</b>	Details of input and output filters, consistent with the CVSD performance requirements of this standard, will be determined in applicable equipment specifications based on validated requirements
--	--

##### A.5.d. Overload Algorithm

A 3-bit shift register shall be used for the CVSD encoder and decoder (see [Figure A-1](#) and [Figure A-2](#)). The overload logic shall operate on the output of this shift register using the run-of-threes coincidence algorithm. The algorithm output signal shall be a binary signal at the data-signaling rate. This signal shall be true for one clock period following the detection of three like bits (all 0s or all 1s) and false at all other times.

##### A.5.e. Compression Ratio

The compression ratio shall be nominally 16:1 with a maximum of 21:1 and a minimum of 12:1. The maximum slope voltage shall be measured at the output of the syllabic filter for a 30 percent run-of-threes digital pattern. The minimum slope voltage shall be measured at the output of the syllabic filter for a 0 percent run-of-threes digital pattern.

##### A.5.f. Syllabic Filter

The syllabic filter shall have a time constant of 5 ms  $\pm$ 1. The step function response of the syllabic filter shall be exponential in nature. When the output of the overload algorithm is true, a charge curve shall be applicable. When the output of the overload algorithm is false, a discharge curve shall be applicable.

##### A.5.g. Reconstruction Integrator Time Constant

The reconstruction integrator shall have a time constant of 1 ms  $\pm$ 0.25.

A.5.h. Analog-to-Digital Conversion

An 800-Hz  $\pm 10$  signal at a 0 dBm0 level applied to the input of the encoder shall give a duty cycle of 0.30 at the algorithm output of the encoder shown in [Figure A-1](#).

A.5.i. Digital-to-Analog Conversion

The characteristics of a digital-to-analog conversion are described in the following subparagraphs.

A.5.i(1) Relation of Output to Input

With the applicable reference digital patterns of [Table A-1](#) applied to the digital input of the decoder as shown in [Figure A-4](#), the analog output signal shall be 800 Hz  $\pm 10$  at the levels shown in [Table A-1](#), measured at the decoder output. These digital patterns, shown in hexadecimal form, shall be repeating sequences.

Table A-1. Decoder Reference Digital Patters for CVSD			
Data Signaling Rate (kbps)	Digital Pattern	Run-of-threes (percent)	Output (dBm0)
16	DB492	0	-24 $\pm$ 1
32	DB54924AB6	0	-24 $\pm$ 1
16	FB412	30	0 $\pm$ 1
32	FDAA10255E	30	0 $\pm$ 1

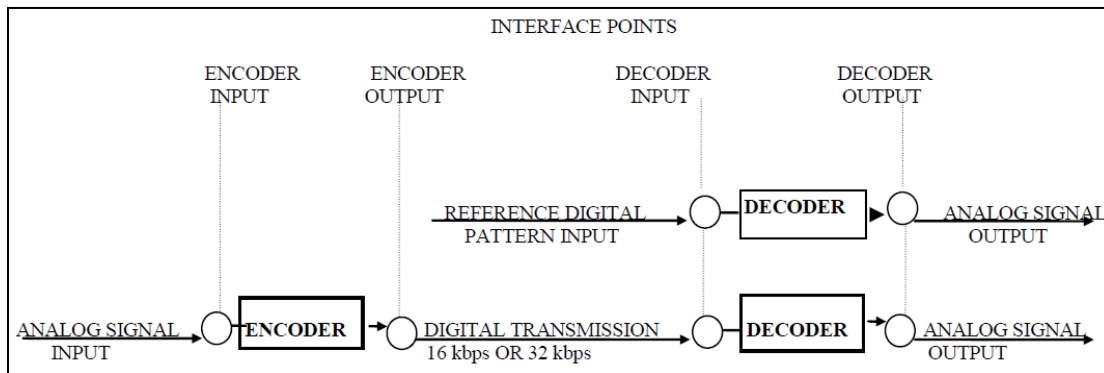

Figure A-4. Interface Diagram for CVSD Converter

A.5.i(2) Conversion Speed

When the decoder input is switched from the 0 percent run-of-threes digital pattern to the 30 percent run-of-threes digital pattern, the decoder output shall reach 90 percent of its final value within 9 to 14 ms. When the decoder input is switched from the 30 percent run-of-threes digital pattern to the 0 percent run-of-threes digital pattern, the decoder output shall reach 10 percent of the 30 percent run-of-threes value within 6 to 9 ms. These values shall apply to both the 16- and 32-kbps data signaling rates.

A.5.j. CVSD Converter Performance

The characteristics specified in subparagraphs [A.5.j\(1\)](#) through [A.5.j\(7\)](#) apply to one CVSD conversion process obtained by connecting the output of an encoder to the input of a decoder (see [Figure A-4](#)).

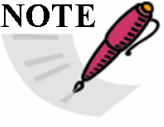

 <p><b>NOTE</b></p>	<p>Test signal frequencies that are submultiples of the data signaling rate shall be avoided by offsetting the nominal test frequency slightly; for example, an 800-Hz test frequency could be offset to 804 Hz. This test frequency offset will avoid nonlinear distortion, which can cause measurement difficulties when CVSD is in tandem with PCM.</p>
--	--

A.5.j(1) Companding Speed

When an 800-Hz  $\pm 10$  sine wave signal at the encoder input is switched from  $-24$  dBm0 to 0 dBm0, the decoder output signal shall reach 90 percent of its final value within 9 to 14 ms.

A.5.j(2) Insertion Loss

The insertion loss between the encoder input and the decoder output shall be 0 dB  $\pm 2$  dB with an 800 Hz  $\pm 10$ , 0 dBm0 input to the encoder.

A.5.j(3) Insertion Loss vs. Frequency Characteristics

The insertion loss between the encoder input and decoder output, relative to 800 Hz  $\pm 10$  measured with an input level of  $-15$  dBm0 applied to the converter input, shall not exceed the limits indicated in [Table A-2](#) and shown in [Figure A-5](#) and [Figure A-6](#).

<b>Table A-2. Insertion Loss Limits for CVSD</b>		
<b>Rate (kbps)</b>	<b>Frequency (f) (Hz)</b>	<b>Insertion Loss (dB) (Referenced to 800 Hz)</b>
16	$f < 300$	$\geq -1.5$
	$300 \leq f \leq 1000$	$-1.5$ to $1.5$
	$1000 \leq f \leq 2600$	$-5$ to $1.5$
	$2600 \leq f \leq 4200$	$\geq -5$
	$4200 \leq f$	$\geq 25$
32	$f < 300$	$\geq -1$
	$300 \leq f \leq 1400$	$-1$ to $1$
	$1400 \leq f \leq 2600$	$3$ to $1$
	$2600 \leq f \leq 3400$	$3$ to $2$
	$3400 \leq f \leq 4200$	$\geq -3$
	$4200 \leq f$	$\geq 25$

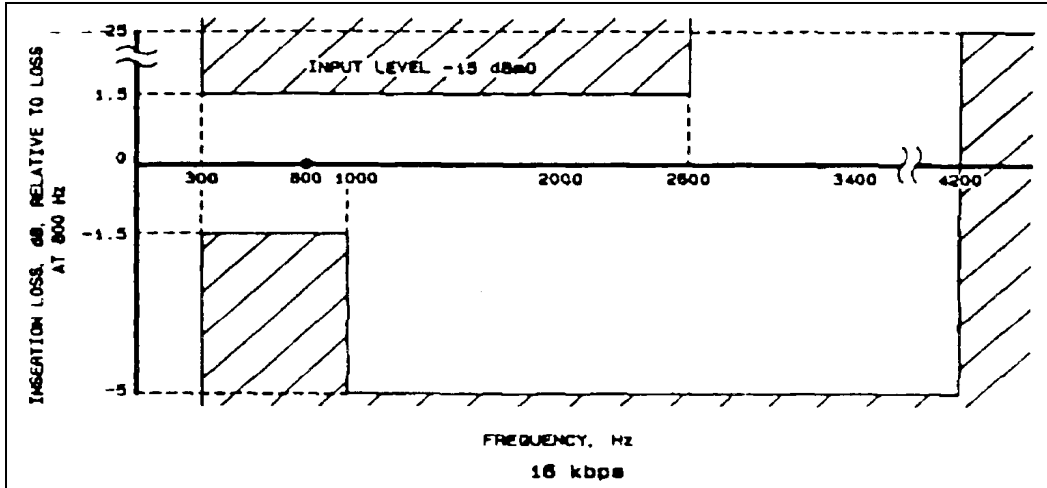

Figure A-5. Insertion Loss vs. Frequency for CVSD (16 kbps)

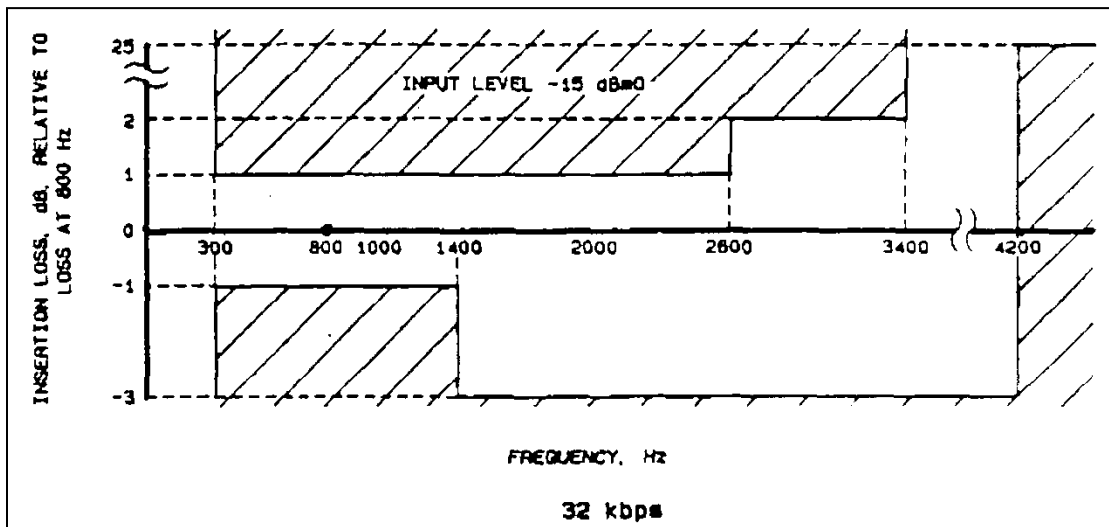

Figure A-6. Insertion Loss vs. Frequency for CVSD (32 kbps)

A.5.j(4) Variation of Gain With Input Level

The variation in output level, relative to the value at -15 dBm0 input, shall be within the limits of [Figure A-7](#) and [Figure A-8](#) for an input frequency of 800 Hz ±10.

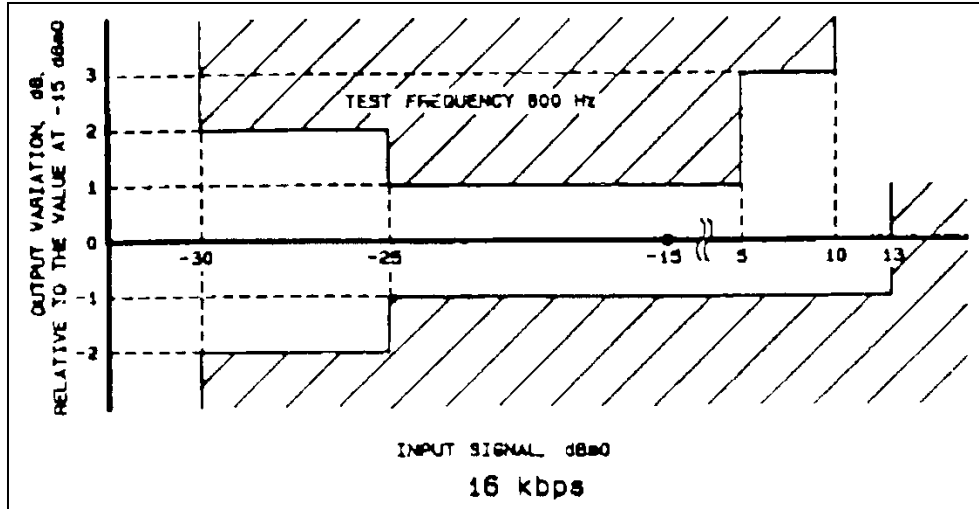

Figure A-7. Variation of Gain with Input Level for CVSD (16 kbps)

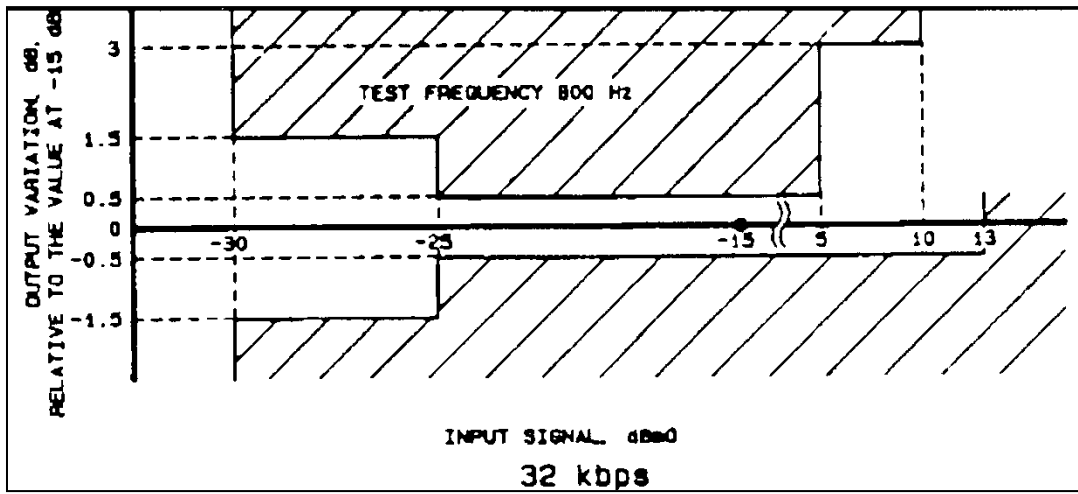

Figure A-8. Variation of Gain With Input Level for CVSD (32 kbps)

A.5.j(5) Idle Channel Noise

The idle channel noise shall not exceed the limits shown in [Table A-3](#) when measured at the CVSD decoder output.

Table A-3. Idle Channel Noise Limits for CVSD	
Data Signaling Rate (kbps)	Idle Channel Noise (dBm0)
16	-40
32	-50

A.5.j(6) Variation of Quantizing Noise With Input Level

The minimum signal to quantizing noise ratio over the input signal level range shall be above the limits of [Figure A-9](#) and [Figure A-10](#). The noise ratio shall be measured with flat weighting (unweighted) at the decoder output with a nominal 800-Hz  $\pm 10$  sine wave test signal at the encoder input.

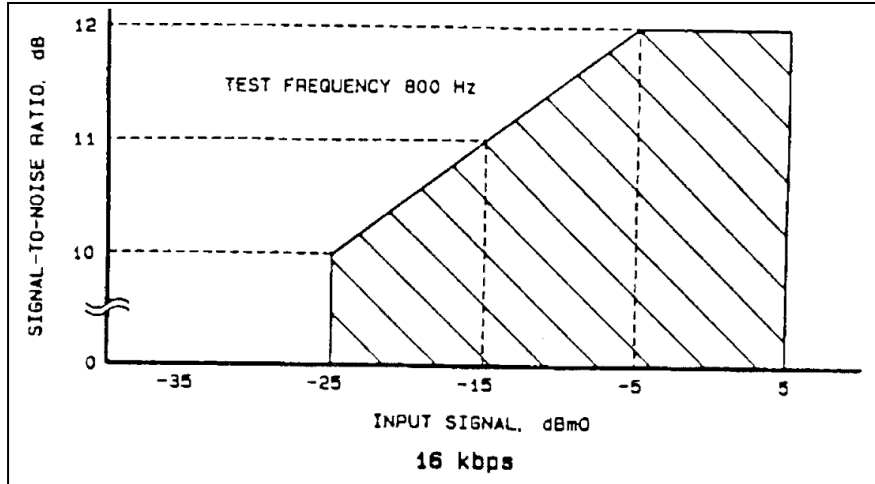

Figure A-9. Signal to Quantizing Noise Ratio vs. Input Level for CVSD (16 kbps)

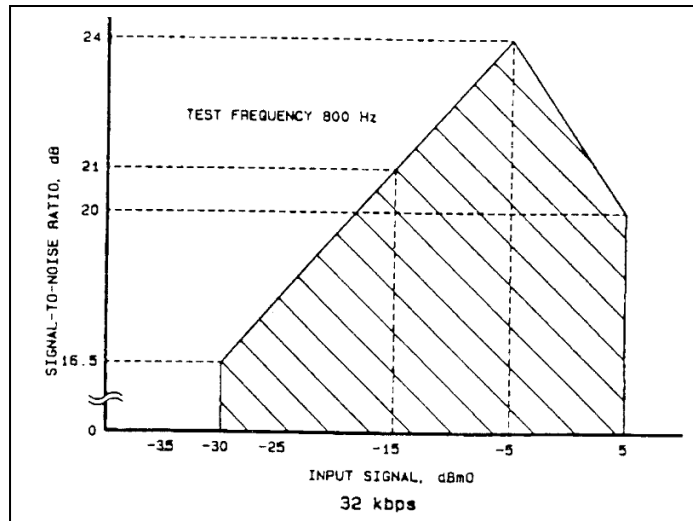

Figure A-10. Signal to Quantizing Noise Ratio vs. Input Level for CVSD (32 kbps)

A.5.j(7) Variation of Quantizing Noise With Frequency

The minimum signal to quantizing noise ratio over the input frequency range shall be above the limits of [Figure A-11](#) and [Figure A-12](#). The noise ratio shall be measured with flat weighting (unweighted) at the decoder output with a sine wave test signal of -15 dBm0.

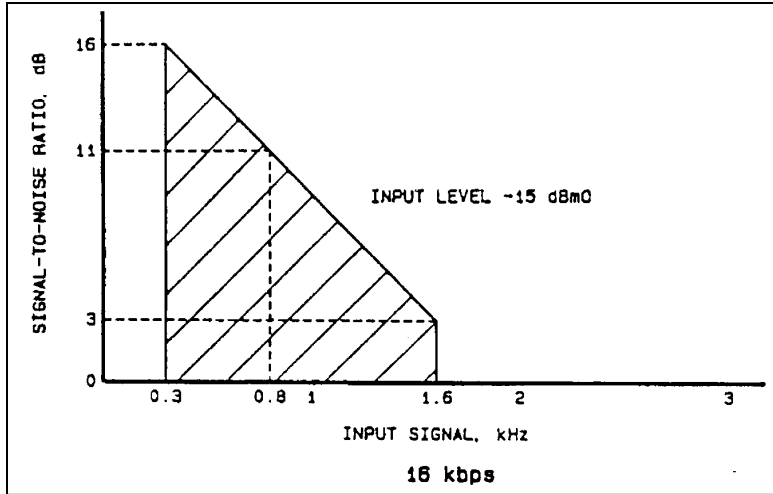

Figure A-11. Signal to Quantizing Noise Ratio vs. Frequency for CVSD (16 Kbps)

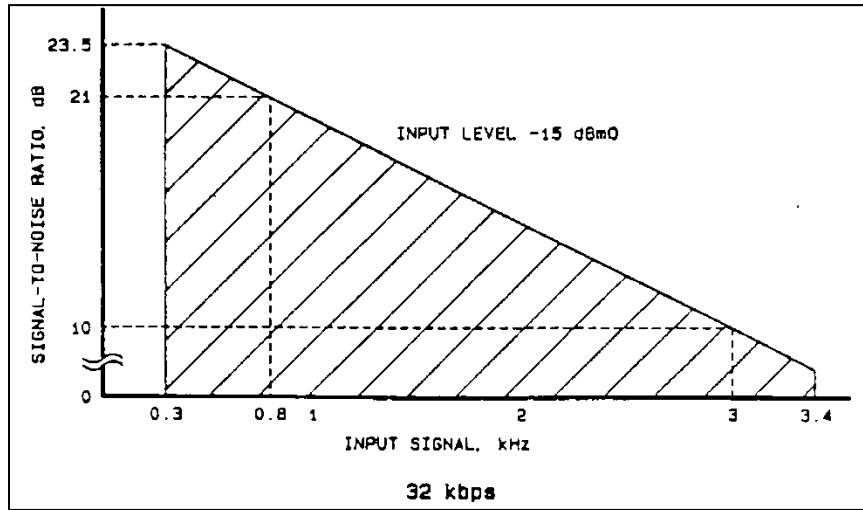

Figure A-12. Signal to Quantizing Noise Ratio vs. Frequency for CVSD (32 Kbps)

This page intentionally left blank.

## **APPENDIX 5-B**

### **Citations**

Daniel T. Laird. Voice encode/decode subsystem in a system for acquisition of test data using pulse code modulation. US Patent 5,557,635, filed September 28, 1994 and issued September 17, 1996.

**\*\*\*\* END OF CHAPTER 5 \*\*\*\***



## CHAPTER 6

### Recorder & Reproducer Command and Control

<b>Acronyms</b> .....	<b>6-v</b>
<b>Chapter 6. Recorder &amp; Reproducer Command and Control</b> .....	<b>6-1</b>
<b>6.1 Introduction</b> .....	<b>6-1</b>
6.1.1 Definitions and Acronyms .....	6-1
6.1.2 Storage Media Structure Hierarchy .....	6-1
6.1.3 Data Flows .....	6-1
6.1.4 Recorder and/or Reproducer States .....	6-6
6.1.5 Recorder and/or Reproducer Features .....	6-8
6.1.6 System Health .....	6-8
<b>6.2 CLI Command and Control</b> .....	<b>6-11</b>
6.2.1 Command Syntax and Rules .....	6-14
6.2.2 Command Error Codes .....	6-14
6.2.3 Mandatory Command Descriptions .....	6-15
6.2.4 Optional Command Descriptions.....	6-24
6.2.5 Command Validity Matrix .....	6-34
6.2.6 Required Command Subset.....	6-35
<b>6.3 MIL-STD-1553 Remote Terminal Command and Control</b> .....	<b>6-36</b>
<b>6.4 Discrete Command and Control</b> .....	<b>6-36</b>
6.4.1 Control and Status Lines.....	6-36
6.4.2 Voltage.....	6-38
6.4.3 Status Updates.....	6-38
<b>6.5 Commands for RMM Devices</b> .....	<b>6-38</b>
6.5.1 Mandatory Commands.....	6-38
6.5.2 Date and Time Setting Requirements .....	6-40
6.5.3 Declassification Supporting Commands.....	6-41
6.5.4 SCSI and iSCSI Commands.....	6-49
6.5.5 Mandatory ORB Formats for the Processor Device Using IEEE 1394b .....	6-49
6.5.6 Additional Mandatory Commands When Using Ethernet .....	6-54
6.5.7 Additional Non-Mandatory Commands When Using Ethernet.....	6-57
<b>Appendix 6.A. MIL-STD-1553 Remote Terminal Command and Control</b> .....	<b>A-1</b>
<b>A.1. Receive Messages</b> .....	<b>A-1</b>
A.1.a. Receive Message Length .....	A-1
A.1.b. Assign Command.....	A-2
A.1.c. BIT Command .....	A-4
A.1.d. Erase Command .....	A-5
A.1.e. Event Command.....	A-6
A.1.f. Info (receive) Command .....	A-8

A.1.g.	Pause Command.....	A-10
A.1.h.	Queue Command .....	A-12
A.1.i.	Record Command .....	A-14
A.1.j.	Replay Command.....	A-15
A.1.k.	Reset Command.....	A-20
A.1.l.	Resume Command .....	A-21
A.1.m.	Sanitize Command.....	A-23
A.1.n.	Stop Command.....	A-25
A.1.o.	Time Command .....	A-26
A.1.p.	Sync Command.....	A-31
<b>A.2.</b>	<b>Transmit Messages.....</b>	<b>A-33</b>
A.2.a.	Transmit Message Length.....	A-33
A.2.b.	Events Command .....	A-33
A.2.c.	Health Command .....	A-35
A.2.d.	Info (transmit) Command .....	A-37
A.2.e.	Status Command .....	A-43
<b>A.3.</b>	<b>Command Acceptability and Validity.....</b>	<b>A-52</b>
<b>Appendix 6-B.</b>	<b>Definitions .....</b>	<b>B-1</b>
<b>Appendix 6-C.</b>	<b>Citations.....</b>	<b>C-1</b>

**List of Figures**

Figure 6-1.	Recording Data Flow .....	6-2
Figure 6-2.	Reproducing Data Flow .....	6-3
Figure 6-3.	Circuit-Looping Live Data Flow .....	6-3
Figure 6-4.	Media-Looping Recorded Data Flow .....	6-4
Figure 6-5.	Publishing Live Data Flow .....	6-4
Figure 6-6.	Publishing Recorded Data Flow .....	6-5
Figure 6-7.	Downloading Data Flow .....	6-5
Figure 6-8.	Uploading Data Flow .....	6-6
Figure 6-9.	Required Discrete Control Functions.....	6-36
Figure 6-10.	Discrete Control and Indicator Functional Diagram.....	6-37
Figure 6-11.	Updating the Bad Block Table.....	6-43
Figure 6-12.	Login ORB Format .....	6-50
Figure 6-13.	Login Response Format .....	6-50
Figure 6-14.	Send Command ORB Format .....	6-51
Figure 6-15.	Send Data Buffer Format .....	6-51
Figure 6-16.	Receive Command Block ORB Format.....	6-52
Figure 6-17.	Receive Data Buffer Format ASCII Format .....	6-53
Figure 6-18.	Receive Data Buffer Binary Format .....	6-54

**List of Tables**

Table 6-1.	State Bit Assignments.....	6-7
------------	----------------------------	-----

Table 6-2.	Use of Status Bits.....	6-8
Table 6-3.	Command Summary .....	6-11
Table 6-4.	Command Error Codes .....	6-15
Table 6-5.	Recorder States .....	6-19
Table 6-6.	PUBLISH_CFG Keywords.....	6-31
Table 6-7.	Command Validity Matrix .....	6-34
Table 6-8.	Required Commands.....	6-35
Table 6-9.	Recorder/Reproducer Status Lines .....	6-38
Table 6-10.	Mandatory Commands (All Interfaces) .....	6-38
Table 6-11.	Additional Mandatory Commands for Declassification .....	6-39
Table 6-12.	Additional Mandatory Commands for Ethernet Interface .....	6-39
Table 6-13.	Non-Mandatory Commands for Ethernet Interface .....	6-40
Table 6-14.	Removable Memory Module .HEALTH Command Response .....	6-40
Table 6-15.	Removable Memory Module States.....	6-48
Table 6-16.	Command Error Codes .....	6-49
Table A-1.	Military Standard 1553 Receive (Bus Controller to Remote Terminal) Command Set.....	A-1
Table A-2.	Military Standard 1553 Transmit (Remote Terminal to Bus Controller) Command Set.....	A-33
Table A-3.	Military Standard 1553 Command Acceptability and Validity .....	A-52

This page intentionally left blank.

## Acronyms

ASCII	American Standard Code for Information Interchange
BC	bus controller
BIT	built-in test
C&C	command and control
CLI	command line interface
DHCP	Dynamic Host Control Protocol
FTP	File Transfer Protocol
IAW	in accordance with
IBIT	initiated built-in test
iSCSI	Internet Small Computer System Interface
lsb	least significant bit
mA	milliamps
MIL-STD	Military Standard
MRTFB	Major Range and Test Facility Base
ms	millisecond
msb	most significant bit
MTU	maximum transmission unit
N/A	not applicable
ORB	operation request block
PCM	pulse code modulation
ppm	parts per million
PTP	Precision Time Protocol
R/R	recorder and/or reproducer
RMM	removable memory module
RSCF	recorder setup configuration file
RT	remote terminal
SCSI	Small Computer System Interface
SSD	solid-state disk
TMATS	Telemetry Attributes Transfer Standard
UDP	User Datagram Protocol
V	volts

This page intentionally left blank.

## CHAPTER 6

### Recorder & Reproducer Command and Control

#### 6.1 Introduction

This chapter defines the standard commands, queries, and status information when communicating with a recorder and/or reproducer (R/R) that uses random access storage (typically either solid-state or magnetic disk). Not all commands (CLI or discrete) may be applicable to all types of R/R implementations. Commands are used to a) control the data flow into and out of, b) request the performance of an internal operation within, and c) request status information from an R/R. The primary intent of this chapter is to cover terminology included in or consistent with the [Chapter 10](#) standard. The CLI and discrete interfaces are divided into two categories of “command sets” as follows:

- a. ***Required:*** The minimum set of discrete and CLI commands for R/R control, query, and status.
- b. ***Optional:*** The optional discrete or CLI command sets that may or may not be implemented and may be shown as references.

This chapter standardizes command and control (C&C) over a variety of different electrical interfaces. These commands can be transmitted via various electrical interfaces (ports) defined in Section 10.7 of [Chapter 10](#), including Military Standard (MIL-STD)-1553, RS-232, RS-422, Small Computer System Interface (SCSI), Fibre Channel, IEEE 1394 (FireWire), internet SCSI (iSCSI) over networks, and Telnet.

When an R/R simultaneously supports multiple interfaces, it must comply with the interface and command precedence specified in this chapter. While this standard may serve as a guide in the procurement of ground and airborne recorders, it is not intended to be a substitute for a purchase specification. This standard does not necessarily conform to, nor does it define, existing or planned capabilities of any given test range.

##### 6.1.1 Definitions and Acronyms

As of RCC 106-17, this section is moved to [Appendix 6-B](#).

##### 6.1.2 Storage Media Structure Hierarchy

Support for multiple data flows to and from multiple storage devices requires hierarchical structures for C&C. The following terms defined in [Appendix 6-B](#) have the following hierarchy from lowest layer to highest layer.

- a. Drive
- b. Volume
- c. File

##### 6.1.3 Data Flows

An R/R has five categories of data interfaces, listed below.

- a. Data input
- b. Data output
- c. R/R to/from Media
- d. Network port(s)
- e. Download port(s)

The figures below identify eight different data flows between these interfaces that are initiated or terminated by commands defined in this chapter. An R/R may simultaneously support more than one of these data flows.

#### 6.1.3.1 Recording

The recording data flow receives live data from input data channels and writes the data in Chapter 10 format to the media. This mode can be activated by the .RECORD command. [Figure 6-1](#) depicts the recording data flow.

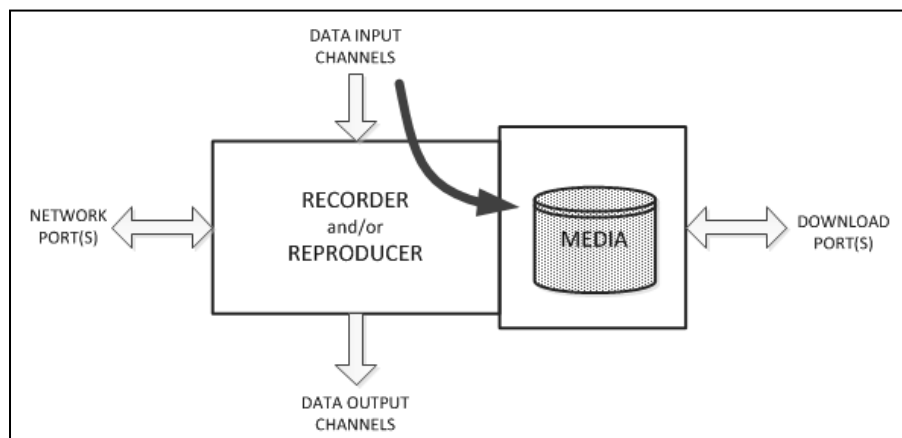

Figure 6-1. Recording Data Flow

#### 6.1.3.2 Reproducing

The reproducing data flow reads Chapter 10 data stored in a file on the media and sends it out on data output channels. [Figure 6-2](#) depicts the reproducing data flow. The output data format may or may not be the same as the original input format, depending on the capabilities of that unique reproducer. For example, video originally input as S-Video (separate Chroma and Luma) may be output as composite. Messages in MIL-STD-1553 format captured from a dual-redundant bus monitor may be reproduced as a Chapter 8 pulse code modulation (PCM) signal. This mode can be activated by the .PLAY command.



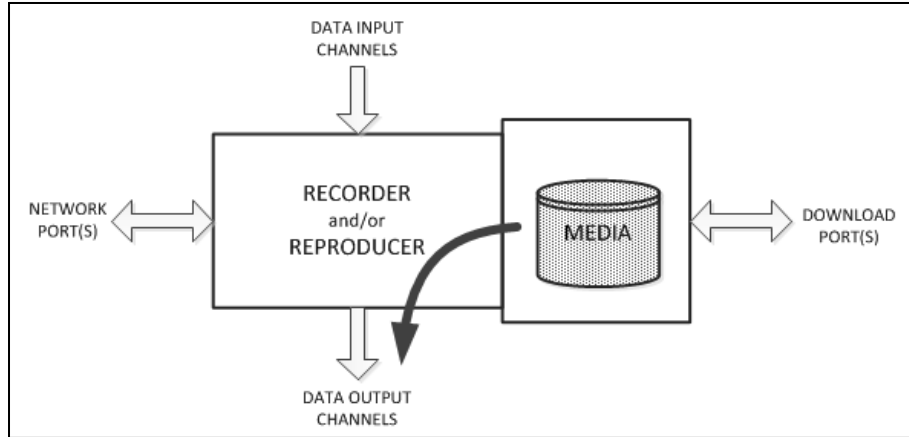

Figure 6-2. Reproducing Data Flow

### 6.1.3.3 Simultaneous Recording and Reproducing

The recording and reproducing data flows can be combined to simultaneously write to and read from the media. The recording and reproducing data rates are independent, and the output may reproduce more or fewer channels than are currently being input. Starting and stopping the recording and reproducing are also independent and may be started and stopped in any order. The combined flows are also referred to as “read-while-write.”

### 6.1.3.4 Looping

The looping data flow combines data input with data output using a common time base on both the input and output. The looping data flow can be divided into live data looping and recorded data looping. Looping may output all or a subset of the input channels.

#### 6.1.3.4.1 Looping Live Data

Circuit-looping live data does not utilize the drive. Data is moved from the input channels directly to the output channels. The output data rates are derived from the data rate of the corresponding data input. This mode can be activated by the .ETOLOOP command. [Figure 6-3](#) depicts the circuit-looping live data flow.

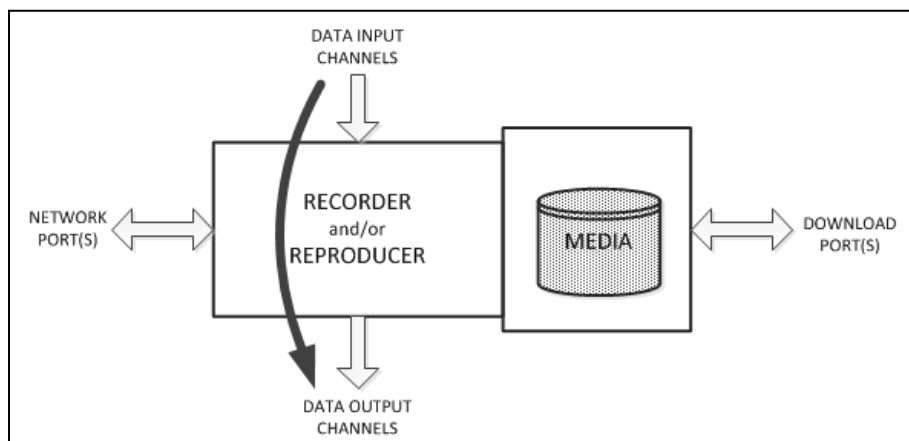

Figure 6-3. Circuit-Looping Live Data Flow

6.1.3.4.2 Looping Recorded Data

Media-looping (or drive-looping) recorded data does involve the media and is commonly referred to as “read-after-write.” The output data rates are derived from the data rate of the corresponding data input. The dotted line in [Figure 6-4](#) depicts the common time base of the recorded and reproduced data when media-looping recorded data. This mode can be activated by the .LOOP command.

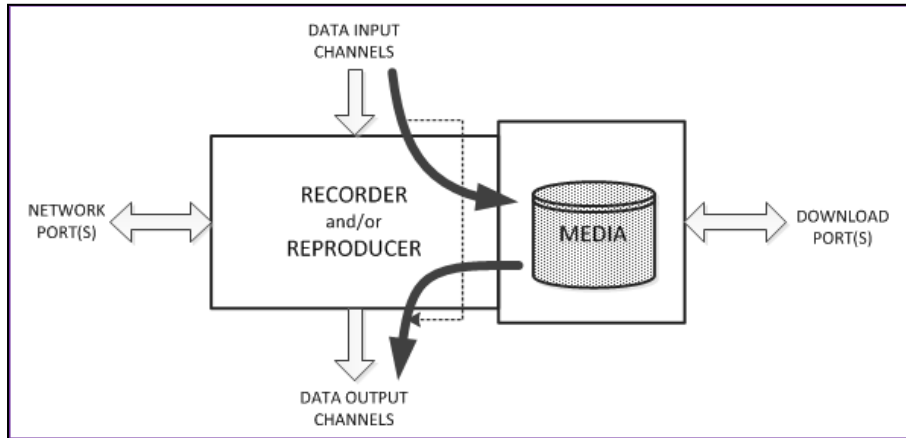

Figure 6-4. Media-Looping Recorded Data Flow

6.1.3.5 Publishing

The publishing data flow is used to transmit live or recorded data in Chapter 10 packet format on a network interface (e.g., Ethernet); note that the network interface used for publishing will typically be distinct from the network interface(s) used for acquisition or reproduction.

6.1.3.5.1 Publishing Live Data

Live data publishing provides minimum latency between input of live data in raw data format and output of packetized Chapter 10 data over a network interface. The data output rate is determined by the live data input rate. [Figure 6-5](#) depicts the broadcasting live data flow. The mode can be activated by the .PUBLISH command.

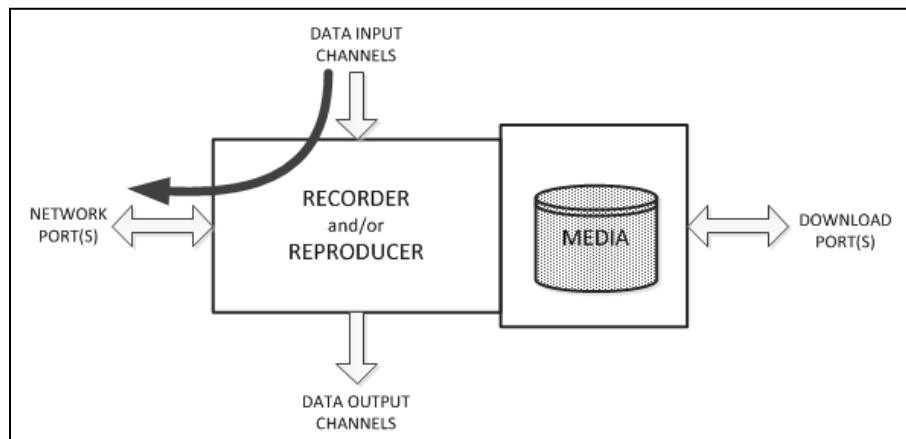

Figure 6-5. Publishing Live Data Flow

6.1.3.5.2 Publishing Recorded Data

Recorded data publishing enables any previously recorded data to be transmitted via a network interface in Chapter 10 packet format. The transmitted data rate is limited by the lesser of the drive access rate and the available network bandwidth and may optionally be constrained to the rate at which the data was recorded. [Figure 6-6](#) depicts the publishing recorded data flow. The mode can be activated by the .PUBLISH FILE command.

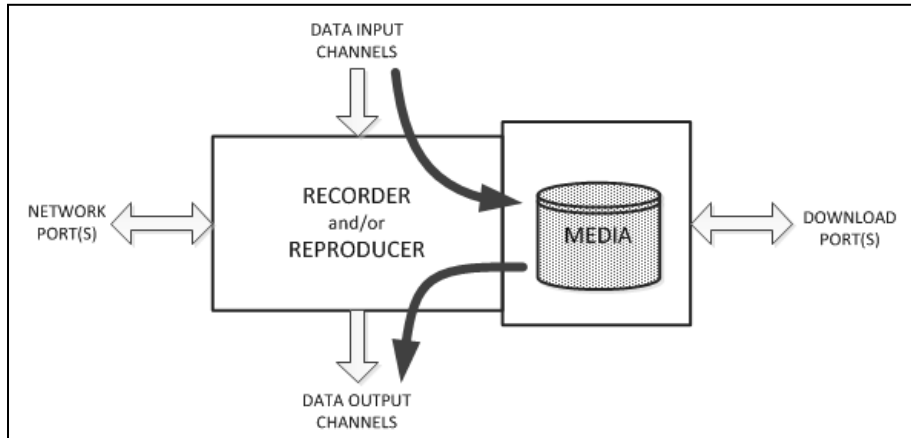

Figure 6-6. Publishing Recorded Data Flow

6.1.3.6 Downloading

The downloading data flow transfers Chapter 10 format data from the drive to the host. For drives formatted as Chapter 10 volumes, the SCSI protocol may be used by the host to access file directories and data files. Downloading files from non-Chapter 10 volumes is outside the scope of this standard. [Figure 6-7](#) depicts the downloading data flow.

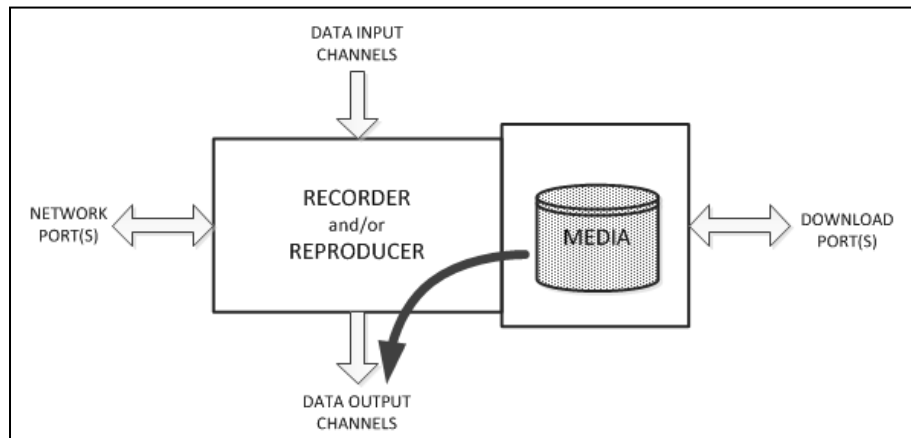

Figure 6-7. Downloading Data Flow

6.1.3.7 Uploading

The uploading data flow transfers Chapter 10 format data from the host to the drive. For drive formatted as Chapter 10 volumes, the SCSI protocol may be used by the host to update file directories and data files. Uploading files to non-Chapter 10 volumes is outside the scope of this standard. [Figure 6-8](#) depicts the uploading data flow.

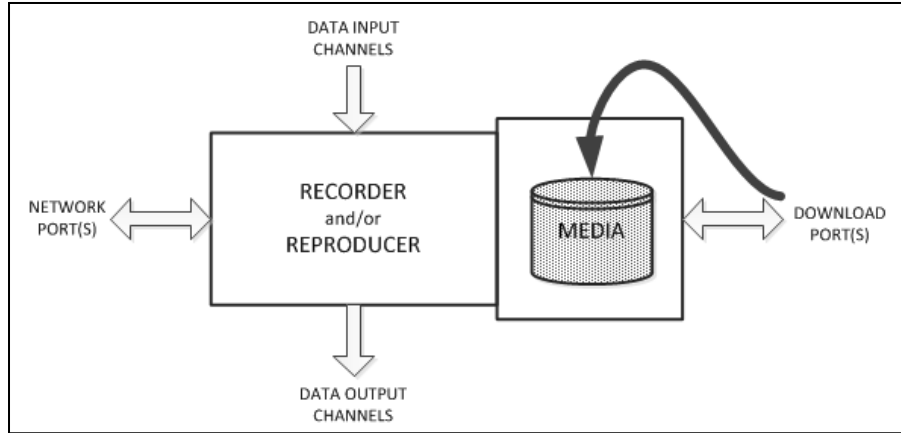

Figure 6-8. Uploading Data Flow

#### 6.1.4 Recorder and/or Reproducer States

Previous versions of the R/R C&C identified eleven states of R/R operation, ten of which are discrete states and one (07) is a combination of two states (05 + 06).

- FAIL (00)
- IDLE (01)
- BIT (02)
- ERASE (03)
- DECLASSIFY (04)
- RECORD (05)
- PLAY (06)
- RECORD & PLAY (07)
- FIND (08)
- BUSY (09)
- COMMAND ERROR (10)

The addition of multiple ports and drives to an R/R requires the definition of new discrete states and new composite states. The state numbers have been redefined so their value is the binary representation of each of the possible discrete states, with composite states represented by simultaneous assertion of multiple discrete state bits. The use of legacy state values is distinguished from the use of these redefined state values by their ranges: legacy states having the values 0 - 10 and new states beginning with 16. [Table 6-1](#) shows the redefined state bits.

**Table 6-1. State Bit Assignments**

3	3	2	2	2	2	2	2	2	2	2	2	1	1	1	1	1	1	1	1	1	9	8	7	6	5	4	3	2	1	0	State Bit / Name						
1	0	9	8	7	6	5	4	3	2	1	0	9	8	7	6	5	4	3	2	1	0																
0	0	0	0	0	0	0	0	0	0	0	0	0	0	0	0	0	0	0	0	0	0	0	0	0	0	0	1	-	-	-	-	IDLE					
0	0	0	0	0	0	0	0	0	0	0	0	0	0	0	0	0	0	0	0	0	0	0	0	0	0	0	1	0	-	-	-	-	FAULT				
0	0	0	0	0	0	0	0	0	0	0	0	0	0	0	0	0	0	0	0	0	0	0	0	0	0	0	1	0	0	-	-	-	-	BIT			
0	0	0	0	0	0	0	0	0	0	0	0	0	0	0	0	0	0	0	0	0	0	0	0	0	0	0	1	0	0	0	-	-	-	-	ERASE		
0	0	0	0	0	0	0	0	0	0	0	0	0	0	0	0	0	0	0	0	0	0	0	0	0	0	0	1	0	0	0	0	-	-	-	-	CLEAN	
0	0	0	0	0	0	0	0	0	0	0	0	0	0	0	0	0	0	0	0	0	0	0	0	0	0	0	1	0	0	0	0	-	-	-	-	SANITIZE	
0	0	0	0	0	0	0	0	0	0	0	0	0	0	0	0	0	0	0	0	0	0	0	0	0	0	0	1	0	0	0	0	0	-	-	-	-	SANITIZE PASS
0	0	0	0	0	0	0	0	0	0	0	0	0	0	0	0	0	0	0	0	0	0	0	0	0	0	0	1	0	0	0	0	0	-	-	-	-	SANITIZE FAIL
0	0	0	0	0	0	0	0	0	0	0	0	0	0	0	0	0	0	0	0	0	0	0	0	0	0	0	0	0	0	0	0	-	-	-	-	reserved	
x	x	x	x	x	x	x	x	x	x	x	x	x	x	x	x	1	0	0	0	0	0	0	0	0	0	0	0	0	0	0	0	-	-	-	-	RECORD	
x	x	x	x	x	x	x	x	x	x	x	x	x	x	x	1	x	0	0	0	0	0	0	0	0	0	0	0	0	0	0	0	-	-	-	-	REPRODUCE	
x	x	x	x	x	x	x	x	x	x	x	x	x	1	x	x	0	0	0	0	0	0	0	0	0	0	0	0	0	0	0	0	-	-	-	-	FIND	
x	x	x	x	x	x	x	x	x	x	x	x	1	x	x	x	0	0	0	0	0	0	0	0	0	0	0	0	0	0	0	0	-	-	-	-	LOOP	
x	x	x	x	x	x	x	x	x	x	x	1	x	x	x	x	0	0	0	0	0	0	0	0	0	0	0	0	0	0	0	0	-	-	-	-	BROADCAST	
x	x	x	x	x	x	x	x	x	x	1	x	x	x	x	x	0	0	0	0	0	0	0	0	0	0	0	0	0	0	0	0	-	-	-	-	BUSY	
x	x	x	x	x	x	x	x	x	1	x	x	x	x	x	x	0	0	0	0	0	0	0	0	0	0	0	0	0	0	0	0	-	-	-	-	COMMAND FAIL	
r	r	r	r	r	r	r	r	r	r	x	x	x	x	x	x	0	0	0	0	0	0	0	0	0	0	0	0	0	0	0	-	-	-	-	reserved		
- = reserved for legacy codes																																					
r = reserved																																					
x = don't care																																					

The R/R states are defined as follows (alphabetical order, at least one of these bits must always be set):

- BIT - A built-in test (BIT) is in progress
- BROADCAST - Transmit live or recorded data out of an Ethernet interface via User Datagram Protocol (UDP) packets
- BUSY - Transition between states
- CLEAN - The drive is being overwritten with all 0s or all 1s
- ERASE - The file table on the drive is being reset to empty
- FAULT - The BIT failed and further diagnostics are required
- FIND - Locate a position within the recorded data on the drive for subsequent replay
- IDLE - The R/R is powered on, ready to accept commands, and no data flows are active
- LOOP - Reproduce live data synchronously with data input with or without recording
- RECORD - Input data, encapsulate into Chapter 10 packets, and store on the drive
- REPRODUCE - Read Chapter 10 data from the drive and output in raw form
- SANITIZE- Perform a secure erase of the attached drive

R/R Command Results:

- COMMAND FAIL - A previous operation, such as BIT or FIND, failed
- SANITIZE FAIL - The sanitize procedure failed

SANITIZE PASS - The sanitize procedure succeeded

6.1.5 Recorder and/or Reproducer Features

Each R/R can be described as a single controller with one or more channels, one or more ports, and some media (typically but not necessarily consisting of one or more discrete drives). A single controller unit may contain multiple processors and/or cores, but it may only have one command sequence. When a controller is capable of receiving commands simultaneously from different sources into its single command sequence, the precedence of the command sources and the resultant operational sequence shall be as defined in this C&C standard. For example, an R/R may have a discrete switch control panel located at the R/R site, a serial port, and may also be connected to a network interface for remote C&C operation.

Both channels and ports may transport data and/or control information. The differentiating factor is that data transferred across ports is already formatted by or for the R/R R/R (e.g., into the packet format mandated by [Chapter 10](#)), whereas data transferred across channels is not. Each data/control channel is identified by a channel ID. Each data/control port is identified by a port ID. The combination of channels, ports, and media managed by the single processor unit of an R/R, and the controller unit itself, are all features of the R/R. Note that some R/R designs will have additional features, such as multiple distinct media types or pools, or built-in processing capabilities (e.g., for real-time display of data); these features are neither precluded nor defined by this standard.

6.1.6 System Health

The system health of an R/R can be stratified into two attribute levels: common (high-level) and device-specific (low-level, typically vendor unique). Common attributes, such as power-on self-test results, are independent of the specific tests performed by unique vendor system architectures. This C&C system provides a method for reporting required health attributes common to all systems and discretionary vendor-specific health attributes.

This C&C system further divides system health status information into two categories: critical and non-critical. Critical faults are typically those that render the R/R inoperable, whereas non-critical faults are informational warnings. This C&C system enables the user to establish the criticality of each reported system health attribute.

The health of each feature is represented by a 32-bit binary word in which each bit represents a single attribute of the feature. The attributes represented by bits 0 through 7 of each feature are common to all R/Rs containing those features and are defined in this standard. The attributes represent by bits 8 through 31 are unique to each R/R and are defined separately in vendor-specific documents.

Any health attribute bit that is set (“1”) indicates a warning or fault. The .HEALTH command is used to retrieve the current state of the health attribute bits for each feature of the R/R. [Table 6-2](#) shows the common attribute bits for currently defined Chapter 10 data types and R/R features.

<b>Table 6-2. Use of Status Bits</b>			
<b>Feature</b>	<b>Bit</b>	<b>Mask (Hex)</b>	<b>Description</b>
System	0	01	BIT Failure

<b>Table 6-2. Use of Status Bits</b>			
<b>Feature</b>	<b>Bit</b>	<b>Mask (Hex)</b>	<b>Description</b>
	1	02	Setup Failure
	2	04	Operation Failure
	3	08	Drive Busy Unable to Accept Command
	4	10	No Drive
	5	20	Drive I/O Failure
	6	40	Drive Almost Full
	7	80	Drive Full
	31-8		Vendor-Specific Health Status Bits
Time Code	0	01	BIT Failure
	1	02	Setup Failure
	2	04	No External Signal
	3	08	Bad External Signal
	4	10	Synchronize Failure
	5	20	Reserved for future Chapter 10 status bit
	6	40	Reserved for future Chapter 10 status bit
	7	80	Reserved for future Chapter 10 status bit
31-8		Vendor-Specific Health Status Bits	
PCM	0	01	BIT Failure
	1	02	Setup Failure
	2	04	Bad Clock Failure
	3	08	Bad Data Failure
	4	10	Minor Frame Sync Failure
	5	20	Major Frame Sync Failure
	6	40	Bit Sync Lock Failure
	7	80	Watch Word Failure
31-8		Vendor-Specific Health Status Bits	
1553	0	01	BIT Failure
	1	02	Setup Failure
	2	04	Response Timeout Error
	3	08	Format Error
	4	10	Sync Type or Invalid Word Error
	5	20	Word Count Error
	6	40	Reserved for future Chapter 10 status bit
	7	80	Watch Word Failure
31-8		Vendor-Specific Health Status Bits	
Video	0	01	BIT Failure
	1	02	Setup Failure
	2	04	No Video Signal Error
	3	08	Bad Video Signal Error
	4	10	No Audio Signal Error
	5	20	Bad Audio Signal Error

<b>Table 6-2. Use of Status Bits</b>			
<b>Feature</b>	<b>Bit</b>	<b>Mask (Hex)</b>	<b>Description</b>
	6	40	Reserved for future Chapter 10 status bit
	7	80	Reserved for future Chapter 10 status bit
	31-8		Vendor-Specific Health Status Bits
Analog	0	01	BIT Failure
	1	02	Setup Failure
	2	04	No Analog Signal Error
	3	08	Bad Analog Signal Error
	4	10	Reserved for future Chapter 10 status bit
	5	20	Reserved for future Chapter 10 status bit
	6	40	Reserved for future Chapter 10 status bit
	7	80	Reserved for future Chapter 10 status bit
31-8		Vendor-Specific Health Status Bits	
Image or Message	0	01	BIT Failure
	1	02	Setup Failure
	2	04	Bad Signal Error
	3	08	Data Content Error
	4	10	Reserved for future Chapter 10 status bit
	5	20	Reserved for future Chapter 10 status bit
	6	40	Reserved for future Chapter 10 status bit
	7	80	Reserved for future Chapter 10 status bit
31-8		Vendor-Specific Health Status Bits	
Other Types	0	01	BIT Failure
	1	02	Setup Failure
	2	04	Bad Signal Error
	3	08	Data Content Error
	4	10	Reserved for future Chapter 10 status bit
	5	20	Reserved for future Chapter 10 status bit
	6	40	Reserved for future Chapter 10 status bit
	7	80	Reserved for future Chapter 10 status bit
31-8		Vendor-Specific Health Status Bits	
Drive	0	01	BIT Failure
	1	02	Setup Failure (Mount)
	2	04	Operation Failure (Processor Command)
	3	08	Drive Busy Unable to Accept Command
	4	10	No Drive
	5	20	Drive I/O Failure
	6	40	Drive Almost Full
	7	80	Drive Full
31-8		Vendor-Specific Health Status Bits	



For single-drive configurations, a single-drive health status can be reported by bits in the System feature. For configurations with multiple drives, each drive is a separate feature specified by the drive ID in the .HEALTH command.

When the Drive feature is used the feature numbers shall not be changed (re-assigned) when the drives are removed / re-plugged from / to the R/R. The drive ID number shall start at 0 and use the same drive numbering as defined in the setup record.

## 6.2 CLI Command and Control

This standard defines a set of commands used to control and monitor the operation of R/Rs. The availability of each command depends on the feature set of the controlled R/R and the specific control port used to send commands to and receive replies from the R/R. [Table 6-3](#) lists the commands in alphabetical order grouped as the mandatory commands followed by optional ones. The protocols used to send these commands to an R/R and receive replies from an R/R are described separately in [Chapter 10](#) Section 10.3, Section 10.4, and Section 10.7 for each of the defined control port types. Each R/R must support at least one of the control port types described in this standard, and may support multiple control port types.

<b>Table 6-3. Command Summary</b>			
<b>Command</b>	<b>Parameters*</b>	<b>Description</b>	<b>M/O</b>
.CRITICAL	[ <i>n</i> [ <i>mask</i> ] ]	Specify and view masks that determine which of the .HEALTH status bits are critical warnings	M
.FILES	[drive ID]	Displays information about each recorded file	M
.HEALTH	[ <i>feature</i> [drive ID] ]	Display detailed status of the recorder system	M
.HELP		Displays table of dot commands supported by the R/R	M
.IRIG106		Returns supported version number of IRIG-106 Recorder Command and Control Mnemonics	M
.IRIG-106		Synonym for .IRIG106	M
.RECORD	[ <i>filename</i> ] [stream-ID] [drive ID]	Starts a recording at the current end of data of [stream ID] to [drive ID]	M
.SETUP	[ <i>n</i> ]	Displays or selects 1 of 16 (0...15) pre-programmed data recording formats	M
.STATUS		Displays the current system status	M
.STOP	[ <i>mode</i> ] [stream-ID] [drive ID]	Stops the current recording, playback, or both	M
.TIME	[ <i>start-time</i> ]	Displays or sets the internal system time	M
.TMATS	{ <i>mode</i> } [ <i>n</i>   ALL]	Write, Read, Save, Delete, Version, Checksum, or Get TMATS file	M
.ASSIGN	[destination-channel ID] [source-channel ID]	Assign replay (output) channels to source (input) channels	O

<b>Table 6-3. Command Summary</b>			
<b>Command</b>	<b>Parameters*</b>	<b>Description</b>	<b>M/O</b>
.BBLIST	{type} [drive ID]	Returns list of secured or unsecured bad blocks	O
.BBREAD	{block identifier} [drive ID]	Returns contents of specified block	O
.BBSECURE	{block identifier} [drive ID]	Marks an unsecured bad block as secure	O
.BIT		Runs all of the built-in-tests	O
.CONFIG		Retrieves Channel Configuration Summary	O
.COPY	[source drive ID] [destination drive ID]	Copies content of source drive to destination drive	O
.DATE	[start-date]	Specify setting or displaying date from recording device	O
.DISMOUNT	[drive ID]	Unloads the recording drive	O
.DRIVE		Lists drives and volumes	O
.DUB	[source drive ID] [destination drive ID]	Image copy. This command is obsolete, but for backward compatibility shall function the same as the .PLAY command.	O
.ERASE	[drive ID] [volume name list]	Erases and format the recording drive	O
.EVENT	[event ID]	Insert an event entry or display captured events list	O
.ETOLOOP	[in stream ID] [out stream ID]	Looping live data mode	O
.FIND	[value [mode] ]	Deprecated (search no longer required)	O
.LOOP	[in stream ID][out stream ID]	Starts record and play in read-after-write mode	O
.MEDIA	[drive ID]	Displays drive usage summary	O
.MOUNT	[drive ID]	Powers and enables the recording drive	O
.PAUSE	[stream-ID]	Pause current replay	O
.PLAY	[location][speed] [drive ID]	Reproduce recorded data of assigned output channels starting at [location], at [speed] from [drive ID]	O
.PUBLISH	[keyword] [parameter]	Configure, start and stop live data over Ethernet	O
.PUBLISH_FILE	[parameter] [ip:port] [file] [stream ID]	Configure, start and stop live data over Ethernet interface from a recorded Chapter 10 file	O
.PUBLISH_TCP	TBD	TBD	O
.PUBLISH_CFG	{keyword}	Configures filters on .PUBLISH streams	O

<b>Table 6-3. Command Summary</b>			
<b>Command</b>	<b>Parameters*</b>	<b>Description</b>	<b>M/O</b>
.OUT_CRATE	[rate [FULL   HASH] ]	Controls the rate at which the configuration/ setup record (TMATS) or checksum of same should be output to the recording stream	O
.QUEUE	[keyword] [parameter]	Specify where to begin replay by event or file number	O
.RCC-106		Synonym for .IRIG106	O
.REPLAY	[location [mode] ]	Same as PLAY	O
.RESET		Perform software initiated system reset	O
.RESUME	[stream-ID]	Resume replay from pause condition	O
.SANITIZE	[drive-ID]	Secure erases the recording drive	O
.STREAM	[#] [stream-ID] [Channel-ID List]	Display specified or all stream channel assignments	O
.TCPPOINTS	[n / n,n,n]	Displays or sets network characteristics	O
.VERBOSE	[mode]	Enables Verbose ON or disables Verbose	O
.VOLUME		Lists volumes on current drive	O
Parameters in braces “{}” are required. Parameters in brackets “[ ]” are optional. When optional parameters are nested (“[xxx [yy]]”), the outer parameter (xxx) must be specified in order to also specify the inner parameter (yy). Parameters separated by a vertical bar “ ” are mutually exclusive alternates.			
The letters in parentheses in front of the command names in the section titles below represent mandatory (M) or optional (O) commands.			

This section describes the protocol for implementing Chapter 6 C&C across a command line interface (CLI), such as an asynchronous serial communication port. Not all commands may be applicable to all types of R/R implementations. An important aspect of the CLI C&C protocol is the required command-response sequence. For each command issued to a recorder, there shall be exactly one response from the R/R, and the response shall begin promptly upon conclusion of the command input. There shall be no delay between the receipt of the command at the recorder and the transmission of the reply by the R/R. The reply must not contain any additional line feeds or carriage returns. Commands that initiate operations or functions that require non-negligible time to complete shall respond immediately, and the status of the R/R may be polled to determine when the operation or function is complete. The rate at which commands may be issued (i.e., the minimum interval between the reply to one command and the next command) is defined by specification, not this standard, as is the response of the recorder if the rate is exceeded. There shall be no unsolicited status output from the R/R, with the single exception of a boot message upon leaving the POWER ON state, indicating that the R/R is ready to accept commands. The boot message shall contain a single American Standard Code for Information Interchange (ASCII) asterisk (“\*”) as the last character. Thereafter, the R/R shall only produce output in response to a command input. (A hardware reset or a software reset shall return the recorder to the POWER ON state.)

### 6.2.1 Command Syntax and Rules

All CLI commands must comply with the following syntax and rules.

- a. All R/R commands are simple ASCII character strings delimited by spaces.
- b. All commands begin with an ASCII period (“.”) and, with the single exception of the .TMATS command, end with the first occurrence of a carriage return and line feed terminator sequence.
- c. Parameters are separated from the commands and from each other with ASCII space characters.
- d. With one exception, command words and parameters may not include spaces. The one exception is the [text string] parameter for the .EVENT command.
- e. Multiple consecutive terminators and extraneous space characters shall not be allowed and shall be ignored.
- f. Each command is followed with either a text response plus a carriage return and line feed and an asterisk response terminator or the asterisk response terminator only, indicating the recorder is ready for the next command.
- g. A response shall be provided by the R/R within one second of the command completion sequence (i.e., line feed).
- h. All numeric parameters, with one exception, are decimal numbers. The one exception is the [mask] parameter for the .CRITICAL command, which is hexadecimal.
- i. Two commands, .FIND, and .REPLAY have numeric parameters requiring units of measure. The [mode] parameter is used to specify the unit of measure (time or blocks). If the [mode] parameter is omitted, the recorder shall use the most recently entered [mode].
- j. A [time] parameter value has five parts: days, hours, minutes, seconds, and milliseconds. Any part not entered defaults to zero except days, which defaults to don’t care (current day). An ASCII period (“.”) identifies the start of the millisecond part, a hyphen (“-”) separates the day from the hours, and colon characters (“:”) separate the hours, minutes, and seconds. The following are valid times: 123- (day only), 17 (hours only), 17:30 (hours and minutes), 17:30:05 (hours, minutes, seconds), 17:0:05 (hours, minutes, seconds), 17:30:05.232 (hours, minutes, seconds, milliseconds), 123-17 (day, hours), 123-17:30 (day, hours, minutes), etc.
- k. All commands begin with an ASCII period and, with the single exception of the .TMATS command, end with a carriage return and line-feed terminator sequence.
- l. Commands are case insensitive (i.e., they may be upper or lower case).

### 6.2.2 Command Error Codes

Issuing invalid commands (bad syntax) or illegal commands (not accepted in the current system state) results in error code responses (with an ASCII “E” identifier) prior to the asterisk response terminator when a command cannot be completed. [Table 6-4](#) shows possible error codes and the conditions under which they occur.

 <p>Example</p>	<pre>.RECORD E 03 *</pre>
	<p>Means: No drive is installed, recording cannot be executed</p>

<b>Table 6-4. Command Error Codes</b>		
Error	Description	Conditions
00	INVALID COMMAND	Command does not exist
01	INVALID PARAMETER	Parameter is out of range, or wrong alpha-numeric type
02	INVALID MODE	Command cannot be executed in the current state
03	NO DRIVE	Drive is dismounted or not installed
04	DRIVE FULL	Command cannot be executed because there is no free space available on the drive
05	COMMAND FAILED	Command failed to execute for any reason other than those listed above
06	BUSY	Command cannot be executed

### 6.2.3 Mandatory Command Descriptions

Commands are listed alphabetically.

#### 6.2.3.1 (M) .CRITICAL [n[*mask*]]

The .CRITICAL command is used to view and specify the critical warning masks used with the .HEALTH command. An encoded 32-bit status word is displayed with the .HEALTH command for each feature as defined in the .HEALTH command in the R/R. The .CRITICAL command allows the user to specify which status word bits constitute critical warnings. If a bit in the .CRITICAL mask word for a feature is set, then the corresponding .HEALTH status word bit for that feature signals a critical warning.

The .CRITICAL command without any parameters returns the mask word for each feature in ascending feature order. The .CRITICAL command with a single parameter - the feature number - returns the list of descriptive warning strings and status word bit associations for the specified feature. The .CRITICAL command with both the feature number parameter and the 8-character ASCII hexadecimal mask value parameter specifies a new mask value for the feature. All mask values in the command responses are hexadecimal.

 <p><b>NOTE</b></p>	<ol style="list-style-type: none"> <li>1. The critical warning is turning the FAULT contact output indicator ON for a Chapter 10-compatible R/R.</li> <li>2. Critical warnings of individual channels should not inhibit recording.</li> </ol>
--	--

 <p>Example</p>	<pre>.CRITICAL 0 FFFFFFFF SYSTEM 1 FFFFFFFF TIMEIN 2 000000FF ANAIN-1</pre>
--	---

```

3 0000006F PCMIN-1
4 0000000F PCMIN-2
:
:
15 00000010 1553IN-8
    
```

Note: The command with no parameters returns the mask for each feature in this and subsequent examples.

**Example** 

```

.CRITICAL 4
4 00000004 PCMIN-2 Bad Clock Failure
4 00000008 PCMIN-2 Bad Data Failure
4 00000010 PCMIN-2 Minor Frame Sync Failure
4 00000020 PCMIN-2 Major Frame Sync Failure
*
    
```

Note: The command with the feature number parameter only, no mask value, returns all of the possible warning text strings for the specified feature and shows which .HEALTH status word bit is associated with the particular warning.

**Example** 

```

.CRITICAL 4 0000003C
4 0000003C PCMIN-2
*
    
```

Note: Entering both the feature number parameter and the mask value parameter resets the mask for the specified feature.

Note: Entering a mask of 0 for the feature number will cause the .HEALTH command to denote a valid state

6.2.3.2 (M) .FILES [drive-ID]

The .FILES command displays a list of character strings showing information about each recording session (file). Each string in the list contains the file number, file name, starting block number, file size in bytes, start day, and start time of the file. For those systems that also store the end day and time of each file, that data may be added to the end of each file string. File names may not contain space or asterisk characters. If user names are not assigned to individual recordings, the default file names shall be “file1,” “file2,” etc. Each file string shall be formatted as shown in the following example (with optional end day and end time).

**Example** 

```

.FILES
1 TPD-10 10000 272760832 001-00:13:58.109 001-
00:14:03.826
2 TPD-11 92884 425984000 001-00:14:11.106 001-
00:14:28.602
3 file3 350790 305430528 123-17:44:06.677 123-
17:44:13.415
    
```

6.2.3.3 (M) .HEALTH [*feature*[drive-ID]]

The .HEALTH command provides a standard mechanism for status information to be conveyed to the user. The feature parameter is defined as 0 for R/R status, and for each data source it is the decimal reference of the channel ID specified by the “TK1” parameter for the corresponding data source by the Telemetry Attributes Transfer Standard (TMATS) setup record. Entering the command without the optional parameter displays a list of encoded status word for each feature. Entering a decimal feature number parameter with the command decodes the status word for a single feature and displays a list of messages pertaining to the feature, one for each set bit in the status word. (See [Table 6-2](#) for recommended usage of the status bits.) This standard requires that the syntax of the responses to the .HEALTH command conform to the following rules.

- a. If no data sources are implemented, the response to a .HEALTH command is the R/R status only.
- b. In addition to the feature number the command should return a description of the corresponding channel type, composed from the channel type of the source as defined in [Chapter 9](#) parameter “CDT” - a “-” character and the sequence number of that type of channel (e.g., “PCMIN-3” for the 3<sup>rd</sup> PCM input channel).
- c. The description of a feature may not contain an asterisk character.
- d. The feature list response (no feature number parameter supplied with the command) is a sequence of text strings, each containing the decimal feature number, the 8-character ASCII hexadecimal representation of the 32-bit status word for the feature, a text feature description, and a carriage return and line feed terminator. The value of the 32-bit status word for a healthy feature shall be all zeros. If a feature is disabled, the 8-character ASCII hexadecimal string shall be replaced with eight ASCII hyphen “-” characters.
- e. The individual feature response (feature number parameter supplied with the command) is a sequence of descriptive text strings, one for each set bit in the feature status word. Each string is terminated with a carriage return and line feed.
- f. The critical bits should be cleared when they are reported by a .HEALTH command.

The .CRITICAL command is used to specify and view the mask word for each feature that determines if a set .HEALTH status word bit adds to the total non-critical or critical warning counts displayed with the .STATUS command.

<p>Example </p>	<b>. HEALTH</b>		
	0	00000000	SYSTEM
	1	00000000	TIMEIN
	2	00000000	ANAIN-1
	3	-----	PCMIN-1
	4	00000034	PCMIN-2
		:	
	15	00000000	1553IN-8
	*		

```

Example  * .HEALTH 4
4 00000004 PCMIN-2 Bad Clock Failure
4 00000010 PCMIN-2 Minor Frame Failure
4 00000020 PCMIN-2 Major Frame Failure
*
```

6.2.3.4 (M) .HELP

The .HELP command displays a list showing a summary of the serial "dot" commands and parameters supported by the R/R as listed in [Table 6-3](#).

```

Example  .HELP
.HELP
.ASSIGN [destination-ID] [source-ID]
.BBLIST {type}
.BBREAD {block identifier}
.BBSECURE {block identifier}
.BIT
.CONFIG
.COPY [source drive ID] [destination drive ID]
.CRITICAL [n [mask]]
.DATE
.
. (full list from Table 6-3)
.
.TMATS {mode} [n|ALL]
*
```

6.2.3.5 (M) .IRIG106

The .IRIG106 command returns the release version number of the Chapter 6 R/R C&C mnemonics that the R/R is supporting. Because this command was introduced in IRIG 106-07, R/Rs supporting earlier releases should respond with the invalid command error message (E00). The .IRIG-106 command is a synonym for the .IRIG106 command.

```

Example  .IRIG106
7
*
.IRIG-106
7
*

Note : This example indicates that the
recorder C&C module is compatible
with IRIG 106-07
```

6.2.3.6 (M) .RECORD [filename] [channel-group ID] [drive ID]

The .RECORD command starts a new recording. The optional file name parameter is an ASCII string with up to 11 characters, beginning with an alphabetic character, and with no spaces or asterisks. If the file name parameter is omitted, the filename will be of the form "file*n*", where *n* is the file number. The recording will continue until the recording drive is full or until



the .STOP command is issued. The optional drive ID is for recorder systems with multiple drives.

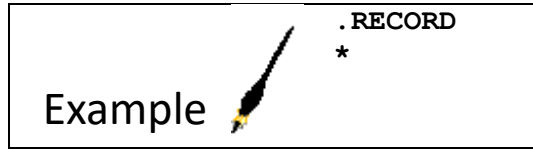

6.2.3.7 (M) .SETUP [n]

The .SETUP command chooses one of 16 pre-defined setups stored in the R/R. The optional parameter is a one- or two-digit decimal setup number from 0 to 15. The current setup may be displayed by omitting the setup number parameter.

The .SETUP command shall return a text "RMM [drive-ID]" if the currently applied setup is retrieved from the removable memory module (RMM).

The .SETUP command shall return a text "NONE" if the currently applied setup is not saved.

The last applied setup number used by the .SETUP command shall be stored in the non-volatile memory of the R/R and automatically used as the default setup after the next power cycle of the R/R.

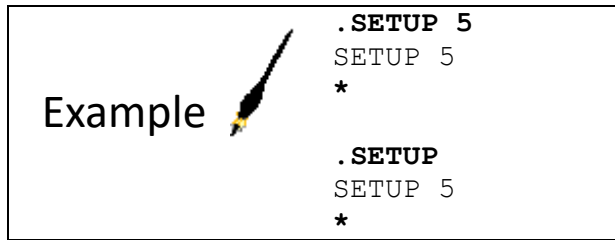

6.2.3.8 (M) .STATUS

The .STATUS command displays the current state of the R/R and two counts. The first is the total number of non-critical warning bits currently set and the second is the total number of critical warning bits currently set. If the R/R is in any state other than FAIL, IDLE, BUSY, or ERROR, the command also displays a progress percentage, the meaning of which is dependent on the specific state. Whenever the R/R is transitioning between states and the transition is not instantaneous, the .STATUS command will return the BUSY state. The ERROR state is entered when the currently executing command does not complete successfully. For example, when a .FIND command is unable to locate the specified position on the drive, the R/R transitions to the ERROR state. [Table 6-5](#) shows the various states by numerical code and describes the meaning of the progress percentage for each state. An ASCII "S" character identifies a .STATUS command response.

Table 6-5. Recorder States		
State Code	State Name	Progress Description
00	FAIL	---
01	IDLE	---
02	BIT	Percent complete
03	ERASE	Percent complete

04	DECLASSIFY	Percent complete
05	RECORD	Percent media recorded
06	PLAY	Percent recording played
07	RECORD & PLAY	Percent media recorded
08	FIND	Percent complete
09	BUSY	---
10	ERROR	---

```

Example 
    .STATUS
    S 03 0 0 84%
    *
    .STATUS
    S 01 0 0
    *
    
```

6.2.3.9 (M) .STOP [*mode*] [stream ID] [drive ID]

The .STOP command stops a recording, playback, or both. The optional mode parameter may be either the word RECORD or the word PLAY. If the optional mode parameter is not specified, both recording and playing (or either of the two modes if the other is not active) will be stopped. Using the parameter enables either recording or playing to be stopped without affecting the other, when both are active.

```

Example 
    .STOP
    *
    
```

```

Example 
    . S 07 0 0 26%
    *
    .STOP PLAY
    *
    .STATUS
    S 05 0 0 26%
    *

    The current state can be displayed with the status command.
    
```

```

Example 
    .STATUS
    S 01 0 0
    *
    .STOP
    E 02
    *

    The .STOP command returns an error if the R/R is
    not in the appropriate state.
    
```

## 6.2.3.10 (M) .TIME [start-time]

The .TIME command displays or sets the internal system's time. The optional start-time parameter is formatted as shown in the example below. Without a parameter, this command displays the current system time.

Example  **.TIME**  
TIME 001-23:59:59.123  
\*

Example  **.TIME 123-13:01:35**  
TIME 123-13:01:35.000  
\*  
To set the time, enter a value expressed in days, hours, minutes, seconds, and milliseconds.

Example  **.TIME 123-**  
TIME 123-00:00:00.000  
\*  
**.TIME 15:31**  
TIME 000-15:31:00.000  
\*  
Note: Trailing values and punctuation may be omitted (zero is default).

## 6.2.3.11 (M) .TMATS {mode} [n]

The .TMATS command provides a vendor-independent mechanism for loading a setup file into the R/R and retrieving a setup file from the R/R. The required mode parameter must be one of the following seven words: WRITE, READ, SAVE, GET, DELETE, VERSION, or CHECKSUM.

Writing or reading a TMATS file transfers the file between the external host and the R/R's internal volatile memory buffer. Saving or getting a TMATS file transfers the file between the R/R's internal volatile memory buffer and the R/R's internal non-volatile setup file storage area. To store a new setup file in the R/R, the .TMATS WRITE command is first used to transfer the file to the recorder, followed by a .TMATS SAVE [n] command to store the file in non-volatile memory. The numeric setup file number parameter is not valid with the .TMATS WRITE command. When saving the file to non-volatile memory, the optional setup file number parameter may be entered to designate a specific setup number (see the .SETUP command). If the setup files number parameter is not specified with the .TMATS SAVE command, the file number defaults to setup 0.

- a. The .TMATS GET [n] command performs the inverse of the .TMATS SAVE command, retrieving the specified or default (0) file from non-volatile to volatile memory within the R/R. If [n] is omitted, it shall retrieve the active TMATS.

- b. The .TMATS READ command transfers the file currently in the R/R’s volatile setup file buffer to the host.
- c. Termination of the .TMATS WRITE command string is unique. All other command strings terminate with the first occurrence of a carriage return and line feed sequence. The .TMATS WRITE command string does not terminate until the occurrence of a carriage return and line feed pair followed by the word END and another carriage return and line feed pair.
- d. The .TMATS DELETE mode accepts either a single setup number [n] or the keyword ALL.
- e. The .TMATS VERSION command returns the version attribute from the current setup record.
- f. The .TMATS CHECKSUM [n] command returns a message digest of the entire specified or default (0) TMATS record excluding only the G\SHA code name, if present. The message digest shall be calculated in accordance with (IAW) Federal Information Processing Standards Publication 180-4<sup>1</sup>, algorithm “SHA-256.” The message digest is a string of 64 lower-case hexadecimal characters, prefixed with the constant string “2-” to designate the algorithm. If the TMATS includes a G\SHA code name, all text between the “G\SHA” and the following semicolon, inclusive, shall be discarded for the purposes of digest calculation.

**Example** 

```

.TMATS WRITE
G\DSI\N=18;
G\DSI-1:TimeInChan1;
G\DSI-2:VoiceInChan1;
G\DSI-3:1553Chan01;
:
:
P-8\IDC8-1:0;
P-8\ISF2-1:ID;
P-8\IDC5-1:M;
END
*

The .TMATS WRITE command places the file into
the volatile buffer of the R/R and applies the setup.
    
```

**Example** 

```

.TMATS READ
G\DSI\N=18;
G\DSI-1:TimeInChan1;
G\DSI-2:VoiceInChan1;
G\DSI-3:1553Chan01;
:
:
P-8\IDC8-1:0;
P-8\ISF2-1:ID;
P-8\IDC5-1:M;
*
    
```

<sup>1</sup> National Institute of Standards and Technology. “Secure Hash Standard (SHS).” FIPS PUB 180-4. August 2015. May be superseded by update. Retrieved 17 May 2021. Available at <http://nvlpubs.nist.gov/nistpubs/FIPS/NIST.FIPS.180-4.pdf>.

The .TMATS READ command returns the file currently in the volatile buffer.

**Example**  **.TMATS SAVE 3**  
\*  
The .TMATS SAVE command stores the file in the volatile buffer to the designated non-volatile file memory in the R/R.

**Example**  **.TMATS GET 3**  
\*  
The .TMATS GET command retrieves the designated file from non-volatile file memory in the R/R and puts it in a buffer that can be read by the user. The retrieved setup will also be applied.

**Example**  COMMENT: \* G-Group - General Information \*; G\PN:TEST\_XYZ;  
G\TA:F16; G\106:09; G\OD:10-22-2009;  
COMMENT: Contact information;  
G\POC\N:1;  
G\POC1-1:Wile E. Coyote;  
G\POC2-1:ACME Corp;  
G\POC3-1:123 Road Runner Way Phoenix AZ 99999; G\POC4-1:(555)555-5555; G\DSI\N:1; G\DSI-1:RF\_DATA\_SOURCE;  
G\SHA:0; G\DST-1:RF; G\SC:U;

**.TMATS CHECKSUM 1**  
2-3af058dc20fd35b82a1beba4de0ed6efa6e5e0ebefe8625494359180d8d16cd  
\*

The .TMATS CHECKSUM [n] command returns the SHA-256 256-bit (32 bytes, 64 hexadecimal characters) message digest of the complete TMATS file stored in position [n] in the recorder.

COMMENT: \* G-Group - General Information \*; G\PN:TEST\_XYZ;  
G\TA:F16; G\106:09; G\OD:10-22-2009;  
COMMENT: Contact information;  
G\POC\N:1;  
G\POC1-1:Wile E. Coyote;  
G\POC2-1:ACME Corp;  
G\POC3-1:123 Road Runner Way Phoenix AZ 99999; G\POC4-1:(555)555-5555; G\DSI\N:1; G\DSI-1:RF\_DATA\_SOURCE; G\SHA:2-3af058dc20fd35b82a1beba4de0ed6efa6e5e0ebefe8625494359180d8d16cd; G\DST-1:RF; G\SC:U;

**.TMATS CHECKSUM 1**  
2-3af058dc20fd35b82a1beba4de0ed6efa6e5e0ebefe8625494359180d8d16cd  
\*

Note the addition of the G\SHA entry does not alter the checksum.

#### 6.2.4 Optional Command Descriptions

Commands are listed alphabetically.

##### 6.2.4.1 (O) .ASSIGN [destination-channel ID] [source-channel ID]

The .ASSIGN command shall be used for assigning output channels to source input channels. The source IDs are composed from the channel type of the source as defined in [Chapter 9](#) parameter Command Data Type - a “-” character and the sequence number of that type of channel (e.g., “PCMIN-3” for the 3<sup>rd</sup> PCM input channel). The destination IDs are composed similarly - but with an “OUT” tag in the Channel Type, instead of an “IN” tag. Use the keyword “NONE” in place of source ID if a channel is to be unassigned. The command with the destination ID parameter only should return the actually assigned source ID; without any parameters it should return the full list of assignments.

**Example**  `.ASSIGN PCMOOUT-6 PCMIN-2`  
 \*  
 Means: PCM input channel 2 will be assigned to PCM output channel 6

**Example**  `.ASSIGN PCMOOUT-6`  
`PCMM-2`  
 \*  
 Means: PCM input channel 2 is currently assigned to PCM output channel 6

**Example**  `.ASSIGN PCMOOUT-1`  
`NONE`  
 \*  
 Means: No channels are assigned to PCMOOUT-1

##### 6.2.4.2 (O) .BBLIST {type} [drive-ID]

A .BBLIST command shall be utilized to return the unsecured bad block identifiers (any ASCII text, one identifier per line) from the drive. A .BBLIST command is only valid following a declassify command. The *type* shall be provided indicating which type of bad block list is to be returned. If *type* = “unsecured”, .BBLIST shall return a list of unsecured bad blocks. If *type* = “secured”, .BBLIST shall return a list of secured bad blocks.

**Example**  `.BBLIST`  
 1234  
 5678  
 :  
 fff  
 \*

6.2.4.3 (O) .BBREAD {block identifier} [drive-ID]

A .BBREAD command shall be utilized to return the raw data from the specified bad block in ASCII hexadecimal format. The block identifier shall be provided for the bad block to be read.

```

Example 
.BBREAD 5678
00040000
*
```

6.2.4.4 (O) .BBSECURE {block identifier} [drive-ID]

A .BBSECURE command shall be utilized to mark an unsecured bad block as being secured. A block that has been identified as secured shall never be used for any subsequent data recording. Secured bad blocks shall be removed from an unsecured bad block identifier list. The block identifier shall be provided for the block to be secured.

```

Example 
.BBSECURE 5678
*
```

6.2.4.5 (O) .BIT

The .BIT command runs the BIT on the R/R. The prompt is returned immediately after the test is started. The .BIT command is only valid in the IDLE, ERROR, and FAIL states. During the BIT, the user must periodically check the status until the test is complete. While in BIT mode, the percent completion is shown with the .STATUS command. The result of the .BIT command is go/no-go status indicated by the end state. If the system returns to the IDLE state, the BIT was successful. If the system goes to the FAIL state, the BIT failed and further system-specific diagnostics are required. The ASCII “S” in the response is the identifier of a .STATUS response.

```

Example 
.BIT
*
.STATUS
S 02 0 0 21%
*
.STATUS
S 02 0 0 74%
*
.STATUS
S 01 0 0
*
```

6.2.4.6 (O) .CONFIG

This command retrieves a channel configuration summary (vendor-defined text format). The command cannot include the ASCII “\*” character.

6.2.4.7 (O) .COPY [source-drive-ID] [destination-drive-ID]

The .COPY command can be used for copying the content from the source drive to the destination drive.

6.2.4.8 (O) .DATE [start-date]

The .DATE [start-date] command displays or sets the internal system date. The optional start-date parameter is formatted as shown in the example below. Without a parameter, this command displays the current system date. The timestamps recorded with user data are derived from this clock. The date shall be set in year-month-day format according to ISO 8601.

Example 	<pre><b>. DATE</b> DATE 2002-12-31 *</pre>

6.2.4.9 (O) .DISMOUNT [drive-ID]

The .DISMOUNT command disables and, if necessary, removes power from the active recording drive. The drive may be removed only after this command is issued.

Example 	<pre><b>. DISMOUNT</b> *</pre>

Example 	<pre><b>. DISMOUNT</b> E 03 *</pre>
	Note: If a failure occurs, an error message is displayed before the prompt

6.2.4.10 (O) .DRIVE

The .DRIVE command gives a list of available drives and volumes defined in the R/R setup record.

6.2.4.11 (O) .DUB [location]

The .DUB command is identical to the .PLAY command, except that it specifies the use of the internal playback clock to retrieve the recorded data.

Example 	<pre><b>. DUB</b> *</pre>

6.2.4.12 (O) .ERASE [drive-ID] [Volume Name]

The .ERASE command logically erases all data on the drive, allowing for recording to begin at the beginning of media.

	This command does not provide assurance that the device is in any way sanitized. Data may still be recoverable.
---	---



The prompt is returned immediately after the operation is started. During erase, the user must periodically check the status until the operation is complete. While in ERASE state, the percent completion is shown with the .STATUS command.

```

Example 
. ERASE
*
. STATUS
S 03 0 0 23%
*
. STATUS
S 03 0 0 84%
*
. STATUS
S 01 0 0
*
    
```

6.2.4.13 (O) .EVENT [event ID]

The .EVENT command adds an event entry as defined in the recording event definitions within the setup record. An event command is defined as a Recorder “R” event type. The event ID defined in the setup record is provided with the command. All other attributes defined with the event ID are applicable so that the command result is an event packet entry for the given event ID. The event command without an event ID shall return a list of captured events. The list shall be <list #><event ID><event time>

```

Example 
. EVENT 5
*
    
```

```

Example 
. EVENT
1 005 00:13:58.109
2 005 00:14:11.106
3 005 01:01:06.677
*
    
```

6.2.4.14 (O) .ETOLOOP [instream-ID] [outstream-ID]

The .ETOLOOP command is used to put the R/R into looping live data mode. Live data does not utilize the drive. Data is moved from the input streams directly to the output streams. The output data rates are derived from the data rate of the corresponding input stream. The R/R may or may not be in data recording mode.

6.2.4.15 (O) .FIND [value [mode]]

The .FIND command is used to report the current record-and-play point or to set the play point to the desired location within the recorded data. The desired location can be expressed in a number of different formats or “modes:” time or blocks. When the command is entered without any parameters, the R/R returns the current record point and current play points, using the current default mode. The default mode is declared each time a mode parameter is supplied with the .FIND command or the .REPLAY command. Thereafter, the mode parameter may be omitted and the R/R will use the default mode. The mode keywords are TIME and BLOCKS.

The location specified in the value parameter of the .FIND command can be numeric or one of six keywords: BOM (beginning of media), BOD (beginning of data), EOD (end of data), EOM (end of media), BOF (beginning of file), and EOF (end of file). These keywords may be used with or without a mode parameter. Numeric location values, whether accompanied by the mode keyword or not, must be valid for the specified or default mode. Blocks are entered as decimal integer numbers. Time is entered as specified in Paragraph [6.2.1](#) item [j](#).

<p style="font-size: 24pt; font-weight: bold;">Example</p> 	<pre> <b>.FIND</b> F 1022312 BOD *</pre>
	<p>Note: Display the current record point and play point. The default mode is blocks.</p>

<p style="font-size: 24pt; font-weight: bold;">Example</p> 	<pre> <b>.FIND 15:33:12 TIME</b> *</pre>
	<pre> <b>.STATUS</b> S 08 0 0 41%</pre>
	<pre> *</pre>
	<pre> <b>.STATUS</b> S 08 0 0 84%</pre>
	<pre> *</pre>
	<pre> <b>.STATUS</b> S 01 0 0 *</pre>
<pre> <b>.FIND</b> F 102-16:18:27.000 102-15:33:12.000 *</pre>	
<p>Note: Find a specific time in the recorded data.</p>	

6.2.4.16 (O) .LOOP [start/stop]

The .LOOP command is used to either start read-after-write mode (which begins recording and simultaneously playing back the recorded data) or stop read-after-write mode. The replayed data is read back from the recording drive. If the R/R is already recording when the .LOOP command is issued, the command starts the playback at the current record point without affecting the recording.

<p style="font-size: 24pt; font-weight: bold;">Example</p> 	<pre> <b>.STATUS</b> S 01 0 0 *</pre>
	<pre> <b>.LOOP</b> *</pre>
	<pre> <b>.STATUS</b> S 07 0 0 35%</pre>
	<pre> *</pre>
	<pre> *</pre>

6.2.4.17 (O) .MEDIA [drive-ID]

The .MEDIA command displays the media usage summary. It shows the number of bytes per block, the number of blocks used, and the number of blocks remaining, respectively.

Example		<b>.MEDIA</b>
		MEDIA 32768 1065349 6756127 *

#### 6.2.4.18 (O) .MOUNT [drive-ID]

The .MOUNT command applies power and enables the device for recording. For systems with multiple memory canisters or media cartridges, the effect of the .MOUNT command on each canister or media cartridge is defined in advance with vendor-specific commands.

Example		<b>.MOUNT</b>
		*

#### 6.2.4.19 (O) .OUT\_CRATE [ rate [type] ]

The .OUT\_CRATE command controls the output rate of periodic copies of the currently active configuration/setup record (TMATS) or the checksum of the currently active configuration/setup record. Both variants (the full TMATS record or the checksum) are sent using Computer-Generated Data, Format 4 packets IAW [Chapter 11](#) Subsection 11.2.7.5; note that these records are treated like any other packet and will be written to the recording media as well as (potentially) be published.

Both variants (full and checksum) may be active concurrently, with the same or different rates.

If present, the rate is specified in seconds and indicates the desired interval between copies. An explicit value of 0 disables the production of the copies. This standard does not dictate the set of acceptable values for the period, but in the event that an implementation cannot precisely match the requested period, then the following approach shall be followed: if the period requested is less than the shortest value supported by the implementation, then the shortest implementation value shall be used; otherwise the greatest supported value less than or equal to the requested value shall be selected.

If the rate is omitted, the value of the TMATS R-x\HRATE-n and R-x\CRATE-n attribute are used, depending on whether the “FULL” or “HASH” variant is selected by the *type* parameter.

If the type parameter is omitted or is specified as the literal text “HASH”, then the checksum of the active setup record using the algorithm defined in Subsection [6.2.3.11.f](#) is written using a packet IAW [Chapter 11](#) Subsection 11.2.7.5; if “FULL” is specified then the complete text of the TMATS record is produced IAW [Chapter 11](#) Subsection 11.2.7.5.

#### 6.2.4.20 (O) .PAUSE [stream-id]

The .PAUSE command stops the replay operation. If parallel recording is being performed, it continues. If no play position is moved in between, the .RESUME command can be used to continue replay. The .PAUSE command can also be used to stop only the replay while the recording continues (in this case, a new replay should be started with a new .PLAY command). If the stream ID is present it will pause only the channels defined by the .STREAM command.



#### 6.2.4.21 (O) .PLAY [*location*] [*speed*] [*drive ID*]

The .PLAY command starts a playback of the data at either the current play point or at the location specified in the optional parameter with the command. The current play point is defined to be the drive location immediately following the most recently played data. If no .PLAY command has been issued since R/R power-on, the current play point is the beginning of data. The location parameter has two forms: [*block\_number*] and [*filename* [*block\_offset*]]. If the first character of the location parameter is numeric, the entire parameter must be numeric, specifying the block number address at which to start the playback. When the first character of the location parameter is alphabetic, the parameter is the filename to play back. It may have a second, optional parameter specifying the numeric 0-origin block offset into the named file. Use the .FIND command, which allows positioning the play point wherever necessary, to begin playing at a location other than a block number or file. The optional [*speed*] parameter specifies the replay speed, if other than real-time replay speed is required. The syntax of the speed specification is: \**N* or /*N* (e.g., \*5 for 5 times faster, /8 for 8 times slower replay).

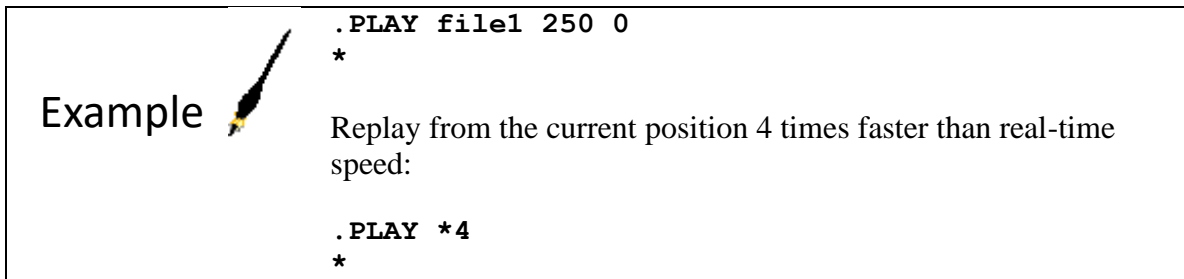

#### 6.2.4.22 (O) .PUBLISH [*keyword*] [*parameter list*]

The .PUBLISH command shall be utilized for configuring, starting, and stopping UDP uni-, multi-, or broadcast of live data in Chapter 11 packet format over any IP interface to the R/R. The following keywords are allowed.

##### .PUBLISH START *IPAddressPortAddressstream-definition*

(Start the streaming of the specified stream definition to the destination address.)

If a new list is defined for the same IP address and PortAddress combination, this will ADD the channels of the new stream definition, not replace them.

##### .PUBLISH STOP *stream-definition*

(Stop streaming of the specified stream definition.)

The *IPAddressPortAddress* parameter defines the destination IP address and the port number of the UDP broadcast.

If the same IP address and PortAddress combination are defined, this will REMOVE only the listed channels of the stream without affecting the other channels.

The *stream-definition* parameter can be:

- A stream ID previously defined using the .STREAM command;
- A channel ID list as defined in the description of the .STREAM command.

The .PUBLISH command without any parameter returns the streaming channel IDs and their destinations.

<b>Example</b> 	<code>.PUBLISH START 192.145.255.255 1234 ALL</code>
	<code>*</code>
	<code>.PUBLISH START ::FFFF:C091:FFFF 1234 ALL</code>
	<code>*</code>
	<code>.PUBLISH</code>
	<code>192.145.255.255 1234 ALL</code>
	<code>*</code>
	<code>.PUBLISH STOP ALL</code>
	<code>*</code>
	<code>.PUBLISH START 192.145.255.255 1234 1-12 18</code>
	<code>*</code>
	<code>.PUBLISH</code>
<code>192.145.255.255 1234 1-12 18</code>	
<code>192.146.255.255 2345 13-17</code>	
<code>*</code>	

6.2.4.23 (O) .PUBLISH\_CFG {keyword}

The .PUBLISH\_CFG command sets or resets modes related to the .PUBLISH commands (including the .PUBLISH\_TCP variant). By default, unless otherwise specified, all modes default to being disabled. Valid keywords are shown in [Table 6-6](#).

<b>Table 6-6. PUBLISH_CFG Keywords</b>		
<b>Enable Keyword</b>	<b>Disable Keyword</b>	<b>Description</b>
BLKFMT1	NOBLKFMT1	Controls whether Format 1 setup records should be blocked from being published.
STREAMID	NOSTREAMID	Controls reporting currently active channels being published.

If BLKFMT1 mode is set, then Computer-Generated Data, Format 1 packets sent on Channel ID 0x0 (e.g., the setup record required to be the first packet in file compliant with [Chapter 11](#)) will be blocked and not sent (published).

If STREAMID mode is set, then a Computer-Generated Data, Format 4 packet IAW [Chapter 11](#) Subsection 11.2.7.5 will be generated when the channels being output by the .PUBLISH command change, including the change from “not PUBLISHING” to “PUBLISHING”. Note that the channel in which the Format 4 packet is placed (channel 0x0) must be included in the active stream definition for the change packet to be published.

6.2.4.24 (O) .PUBLISH\_FILE [keyword][parameter list]

The .PUBLISH\_FILE command shall be utilized for configuring, starting, and stopping UDP uni-, multi-, or broadcast of recorded data from a medium in Chapter 11 packet format over any IP interface of the R/R.

*.PUBLISH\_FILE START/STOP IPaddressPortAddress file-name [start-time] [stop-time] [speed] stream-definition*

The first parameter is mandatory and must be either START or STOP.

The IPaddressPortAddress parameter defines the destination IP address and the port number of the UDP broadcast.

The optional start-time parameter specifies the absolute time of the first packet to be sent out from the file.

The optional stop-time parameter specifies the absolute time of the last packet to be sent out from the file.

The optional speed specifies the speed of the UDP broadcast. It can be one of the following keywords:

FULL: maximum speed the R/R and media are capable;

REALTIME: near-real-time streaming - as close as possible to the original live data streaming;

MBPS <n>: with a specified average bit rate in megabits per second.

The *FileName* parameter defines the file to be sent out as UDP stream.

The *stream-definition* parameter can be:

- A stream-ID defined previously in the .STREAM command;
- A channel-ID list as defined in the description of the .STREAM command.

<p><b>Example</b> </p>	<code>.PUBLISH_FILE START File1.ch10 Stream2</code>
	<code>*</code>
	<code>.PUBLISH_FILE STOP File1.ch10</code>
	<code>*</code>
	<code>.PUBLISH_FILE</code>
	<code>File1.ch10 192.145.255.255 1234 1-12 18</code>
	<code>*</code>

6.2.4.25 (O) .PUBLISH\_TCP [keyword][parameter list]  
[TBD]

6.2.4.26 (O) .QUEUE [keyword] [parameter]

The .QUEUE command is used to specify a recorded data file or defined data event at which to begin the next replay. Replay must be stopped prior to issuing the .QUEUE command. Keyword options are either event or file. The parameter option represents either the event or file number from which to begin replay.

6.2.4.27 (O) .RCC-106

The .RCC-106 command is a synonym for the .IRIG106 command

6.2.4.28 (O) .REPLAY [location [mode]]

The .REPLAY command initiates a repeated playback from the current play point to the end point specified in the command, using an internal clock to “gate” the data. The syntax of the endpoint parameter is identical to that of the .FIND command.

6.2.4.29 (O) .RESET

The .RESET command performs a software-initiated reset of the R/R, returning the R/R to the power-on state. The effect shall be identical to a power cycle.

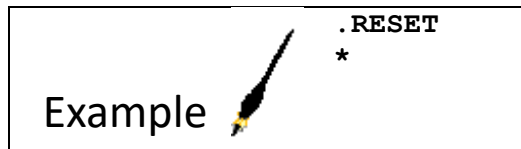

6.2.4.30 (O) .RESUME [stream-id]

The .RESUME command can be used to continue the replay from the location where it was stopped by the .PAUSE operation - with the replay speed specified at the last .PLAY command. If the play position was moved with the .FIND command since the .PAUSE command was used, the replay cannot be continued by the .RESUME command - a new .PLAY command should be issued. If the stream-id is present it will pause only the channels defined by the .STREAM command.

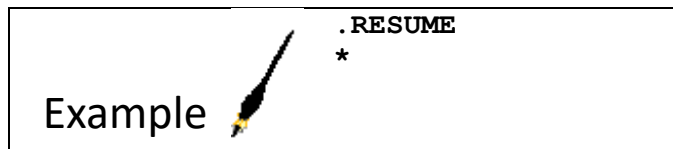

6.2.4.31 (O) .SANITIZE [drive-ID]

The .SANITIZE command erases all recorded data using the sanitization procedure specific to that recorder.



This command will permanently erase all recorded data. Data cannot be recovered once this command has been executed! Note that this command makes no representation that any given recorder’s sanitization procedure is appropriate for a particular application. Rather, if the recorder has an appropriate procedure, then this command initiates it.

The prompt is returned immediately after the operation is started. During sanitize, the user must periodically check the status until the operation is complete. While in the SANITIZE state, the percent completion is shown with the .STATUS command.

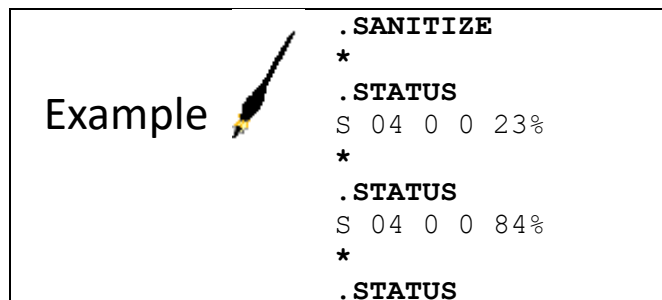

S 01 0 0
*

6.2.4.32 (O) .STREAM [stream ID] [channel ID list]

The .STREAM command displays specified or all stream channel assignments.

6.2.4.33 (O) .VERBOSE [*mode*]

The .VERBOSE command enables or disables verbose mode with the ON or OFF keywords.

6.2.4.34 (O) .VOLUME

The .VOLUME command gives a list of available volumes defined in the TMATS.

6.2.5 Command Validity Matrix

[Table 6-7](#) identifies the R/R states in which each of the serial commands is valid. The legend at the bottom of the table explains the matrix entry codes. Two codes, 3 and 4, identify states in which the associated command may or may not be valid due to system-specific implementation. The R/R users should assume that a command is not supported in a system-specific state (code 3 or 4) unless the specific R/R's interface control document assures that support is provided.

<b>Table 6-7. Command Validity Matrix</b>												
<b>Command</b>	<b>State</b>											
	<b>BUILT-IN TEST</b>	<b>BUSY</b>	<b>DECLASSIFY</b>	<b>ERASE</b>	<b>ERROR</b>	<b>FAIL</b>	<b>FIND</b>	<b>IDLE</b>	<b>PLAY</b>	<b>POWER ON</b>	<b>RECORD</b>	<b>RECORD &amp; PLAY</b>
.ASSIGN					X	X		X			X	
.BBLIST, .BBREAD, .BBSECURE								1				
.BIT					X	X		X				
.CONFIG	X		X	X	X	X	X	X	X		X	X
.CRITICAL	2		2	2	2	2	2	2	2		2	2
.DATE	2		2	2	2	2	2	2	2		2	2
.DISMOUNT					3			3				
.DRIVE	X		X	X	X	X	X	X	X		X	X
.DUB					X			X			X	
.ERASE					X			X				
.EVENT (*)	X				X	X	X	X	X		X	X
.FILES	X				X	X	X	X	X		X	X
.FIND					X			X			X	
.HEALTH	X		X	X	X	X	X	X	X		X	X
.HELP	X		X	X	X	X	X	X	X		X	X
.IRIG106	X	X	X	X	X	X	X	X	X		X	X



.LOOP					X			X			X	
.MEDIA	X				X	X	X	X	X		X	X
.MOUNT					3			3				
.PAUSE (*)					X			X			X	
.PLAY (*)					X			X			X	
.PUBLISH (*)					X			X	X		X	X
.PUBLISH_CFG					X			X				
.OUT_CRATE					X			X	X		X	X
.QUEUE												
.RECORD (*)					X		X	X	X			
.REPLAY					X			X			X	
.RESET	X	X	X	X	X	X	X	X	X		X	X
.RESUME (*)					X			X			X	
.SANITIZE (*)					X			X			X	
.SETUP	2		2	2	2	2	2	2	2		2	2
.STATUS	X	X	X	X	X	X	X	X	X		X	X
.STOP							X		X		X	X
.STREAM	X		X	X	X	X	X	X	X		X	X
.TIME	2		2	2	2	2	2	2	2		2	2
.TMATS					X			X				
.VOLUME	X		X	X	X	X	X	X	X		X	X
<b>Legend</b>												
X = Always valid.												
1 = Only valid after declassify command execution has completed.												
2 = Query function always valid. Changing masks, setup, or time only valid in IDLE or ERROR.												
3 = MOUNT and DISMOUNT only valid if not mounted or dismounted, respectively.												
Commands marked (*) may have implementation-specific restrictions.												

6.2.6 Required Command Subset

[Table 6-8](#) identifies the minimum subset of commands that must be implemented for each R/R type to be compliant with this standard.

<b>Table 6-8. Required Commands</b>			
<b>Command</b>	<b>Recorder Type</b>		
	<b>Tape</b>	<b>Solid-State</b>	<b>Disk</b>
.BIT	M	M	M
.CRITICAL	M	M	M
.DATE	M	M	M
.DECLASSIFY	O	M	O
.DISMOUNT	M	M	M
.ERASE	M	M	M
.FILES	O	M	M

.HEALTH	M	M	M
.HELP	M	M	M
.IRIG106	M	M	M
.MEDIA	M	M	M
.MOUNT	M	M	M
.RECORD	M	M	M
.RESET	M	M	M
.SETUP	M	M	M
.STATUS	M	M	M
.STOP	M	M	M
.TIME	M	M	M
.TMATS	M	M	M
Legend			
M= Mandatory O = Optional			

**6.3 MIL-STD-1553 Remote Terminal Command and Control**

As of RCC 106-17, this section is moved to [Appendix 6-A](#).

**6.4 Discrete Command and Control**

Any R/R that implements discrete C&C shall implement the functions described herein. Required discrete control functions are noted in [Figure 6-9](#).

Description
RECORD
ERASE
SANITIZE
ENABLE
BIT

Figure 6-9. Required Discrete Control Functions

**6.4.1 Control and Status Lines**

Five contacts for discrete control and five lines for indicating status shall be provided. All the lines are “active low”: grounding a control line (or causing the indicator line to go to ground) referenced to the recorder’s ground activates the function as shown in [Figure 6-10](#). Note that the circuit shown in [Figure 6-10](#) is for reference only, and specific installations may require alternative arrangements that are beyond the scope of this standard.

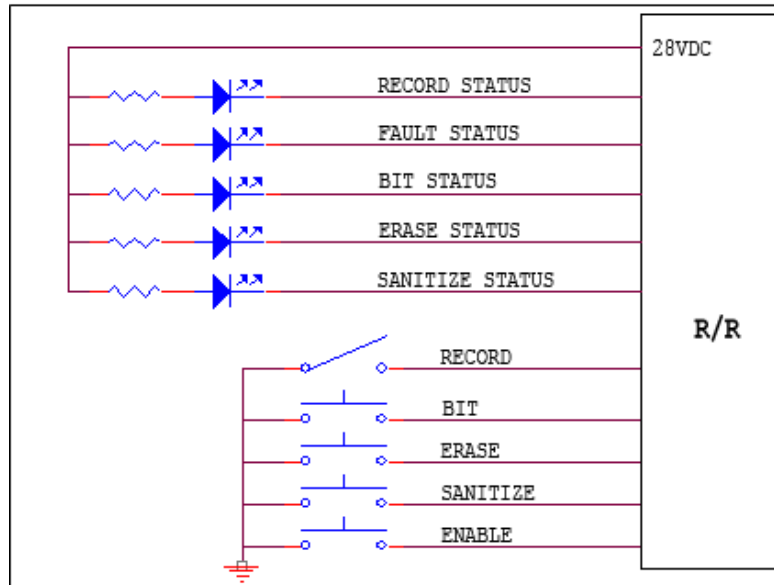

Figure 6-10. Discrete Control and Indicator Functional Diagram

#### 6.4.1.1 Activation

All control inputs are activated by being brought to 0.55 volts (V) or less. Inputs using momentary switches must be active for 0.5 seconds for the associated command to be invoked. All status outputs are set to be “ON” by the R/R bringing the voltage to 0.55 V or less. The “OFF” state is designated by the output being open circuit. When “ON”, the current in the circuit shall not exceed 60 milliamps (mA).

#### 6.4.1.2 Controls

**BIT Command:** Activated by a momentary switch, this discrete control commands the recorder to start the BIT procedure.

**Enable Command:** Activated by a momentary switch, this discrete control must be asserted simultaneously with either the ERASE or SANITIZE discrete for that control to operate.

**Erase Command:** Activated by a momentary switch, this discrete control commands the recorder to erase its user data and file directory memory provided the ENABLE switch is also activated.

**Record Command:** Activated by a toggle switch, this discrete control commands the recorder to start recording. Recorder will remain in this mode for the duration that the switch is active (i.e., closed).

**Sanitize Command:** Activated by a momentary switch, this discrete control causes the recorder to start the SANITIZE procedure provided the ENABLE switch is also activated.

**BIT Status:** The built-in test is running.

**Erase Status:** The media is erased or in the process of being erased.

**Fault Status:** The R/R is not ready or a critical warning has been posted.

**Record Status:** The R/R is recording.

**Sanitize Status:** The media is sanitized or is in the process of being sanitized.

6.4.2 Voltage

28 volts direct current auxiliary voltage output shall be provided from the discrete/control port (250 mA max, short circuit protection). A ground reference point shall be provided.

6.4.3 Status Updates

The status reflected by the output lines shall be updated to match the actual status of the R/R at least once every 2 seconds. Whenever a status is activated (“ON”), it shall remain ON for a minimum interval not less than one second; status lines may flash (with a duty cycle of 500 milliseconds [ms] ON, 500 ms OFF) to indicate that the R/R is in the process of accomplishing the related status. [Table 6-9](#) summarized the meanings associated with each status line.

<b>Table 6-9. Recorder/Reproducer Status Lines</b>			
<b>Status Line</b>	<b>On</b>	<b>Flash</b>	<b>Off</b>
ERASE	Media erased.	Media is being erased.	Media is not erased.
RECORD	R/R is recording.	-	R/R is not recording.
FAULT	R/R is not ready, or any of the critical warning exists.	-	R/R is running properly. No critical warning.
BIT	Built-in test running.	-	Built-in test is not running.
SANITIZE	Media sanitized.	Media sanitization is in progress.	Media is not sanitized.

6.5 **Commands for RMM Devices**

6.5.1 Mandatory Commands

The mandatory commands for all RMM devices are listed in [Table 6-10](#). Additional commands that are mandatory for all RMM devices that support declassification are listed in [Table 6-11](#). Commands that are mandatory for RMM devices that support the Ethernet host platform interface via Telnet are listed in [Table 6-12](#), with optional Ethernet commands listed in [Table 6-13](#).

<b>Table 6-10. Mandatory Commands (All Interfaces)</b>		
<b>Command</b>	<b>Parameters</b>	<b>Description</b>
.BIT		Runs all of the RMM BITs.
.CRITICAL	[n [mask] ]	Specifies and views masks that determine which of the .HEALTH status bits are critical warnings.
.DATE	[start-date]	Specifies setting or displaying date from RMM.
.ERASE		Erases the RMM media.
.HEALTH	[feature]	Displays detailed status of the RMM.
.IDENTIFY		Queries the RMM for solid-state memory identification and firmware version.

**Table 6-10. Mandatory Commands (All Interfaces)**

Command	Parameters	Description
.INITIALIZE		Initializes RMM internal components.
.IRIG106		Retrieves the IRIG-106 supported version number.
.MEDIA P		Queries the RMM for information about the physical media of the RMM and the transfer limits for the required physical input/output (I/O) commands.
.STATUS		Displays the current RMM status.
.TIME	[start-time]	Displays or sets the internal system time.

**Table 6-11. Additional Mandatory Commands for Declassification**

Command	Parameters	Description
.BBLIST		Directs the RMM to retrieve the bad block list.
.BBLIST R		Retrieves the bad block list from the RMM.
.BBREAD	{block identifier}	Returns contents of specified block in ASCII hexadecimal byte format.
.BBREAD P	{block identifier}	Directs the RMM to initiate a physical block read of the specified physical block identifier.
.BBREAD D		Retrieves the data from the physical block. See the .MEDIA P command for information. Data is returned in binary format.
.BBSECURE	{block identifier}	Marks an unsecured bad block as secure.
.DECLASSIFY		Initiates command as specified by user specification or user CONOP overwrite procedures.
.PBWRITE P	{block identifier}	Directs the RMM to initiate a physical block write of the specified physical block identifier.
.PBWRITE D		Writes the data to the physical block in binary format. See the .MEDIA P command for information.
.SANITIZE		Initiates a memory clear and identification of bad memory blocks.

**Table 6-12. Additional Mandatory Commands for Ethernet Interface**

Command	Parameters	Description
.MEDIA E		Queries the RMM about which protocols it supports.
.RMMIP		Displays RMM IP address and associated settings. Mandatory only with Ethernet host platform interface.
.RMMIP	keyword [parameter]	Displays and controls RMM IP addressing. Mandatory only with Ethernet host platform interface.
.TIME	[PTPSTATUS  PTP]	Displays and controls the IEEE 1588 Precision Time Protocol (PTP) (if implemented).
.TMATS	GET	Recovers the recorder setup configuration file (RSCF) from the RMM storage.
.TMATS	READ	Displays the RSCF.

**Table 6-12. Additional Mandatory Commands for Ethernet Interface**

Command	Parameters	Description
.TMATS	SAVE [n]	Saves the RSCF using n to form file name.
.TMATS	WRITE	Uploads an RSCF.

**Table 6-13. Non-Mandatory Commands for Ethernet Interface**

Command	Parameters	Description
.RMMFRAME		Displays the current and largest maximum frame size.
.RMMFRAME	Frame size	Sets the maximum frame size.
.TCPPOINTS		Displays a comma-separated list of the TCP port numbers used for the Telnet, File Transfer Protocol (FTP), and iSCSI services.
.TCPPOINTS	port1,port2,port3	Sets the ports used for the network services.

The RMM .HEALTH command response is presented in [Table 6-14](#).

**Table 6-14. Removable Memory Module .HEALTH Command Response**

	Bit	Mask	Description
RMM	0	01	Bit failure
	1	02	Setup failure (unable to set the time or date properly)
	2	04	Operational failure (I/O error, media error, etc.)
	3	08	Low or dead battery warning
	4	10	RMM busy
	5	20	Reserved for future Chapter 10 status bit
	6	40	Reserved for future Chapter 10 status bit
	7	80	Reserved for future Chapter 10 status bit
	8-31		Vendor-specific health status bits

## 6.5.2 Date and Time Setting Requirements

To set time, the .TIME commands should be used according to Subsection [6.2.3.10](#).

### 6.5.2.1 Time Setting Using IEEE 1394b

To guarantee avoiding uncontrolled delay, the following algorithm shall be used.

- a. The host device puts a .TIME command with time parameter to be set in its SEND buffer and sends it at least 100 ms prior to the correct time to the real-time clock device. The delay is necessary to allow the processor device to be prepared for the exact time setting and to hold off enough in the host to force a doorbell with the next SCSI command. Without enough delay the host will not be able to chain the next SCSI command together with the previous command. If the operating system demands it a delay greater than 100 ms can be used.

- b. The processor device shall process this time and be prepared to set it at receipt of the doorbell.
- c. A .SEND command shall be sent to the real-time clock with the message .TIME without parameters to query for the time as set.

### 6.5.2.2 Time Setting using Ethernet

To minimize inaccuracy, the IEEE 1588 PTP may be used. How an RMM derives time from PTP is not controlled by the standard. The .TIME PTP and .TIME PTPSTATUS variants of the .TIME command shall be used to enable and view the status of the PTP implementation.

### 6.5.2.3 Date Setting Requirements

A .DATE [start-date] command shall be utilized for setting or displaying date of the removable memory real-time clock. The date shall be set in year-month-day format according to ISO Standard 8601:2004.

<div style="display: flex; align-items: center;"> <div style="margin-right: 20px;"> <p><b>Example</b></p>  </div> <div> <pre><b>. DATE</b> DATE 2002-12-31</pre> </div> </div>
---

## 6.5.3 Declassification Supporting Commands

### 6.5.3.1 .IDENTIFY

A .IDENTIFY command queries the RMM for solid-state disk (SSD) identification and firmware version.

- Description

This command queries the RMM for SSD identification information and firmware version.

- Parameters

None

- Response

The RMM responds with one line containing five comma-separated fields. Characters and spaces are allowed within the comma-separated fields. Response time shall be within 100 ms. A .STATUS command request prior to 100 ms shall elicit a BUSY response.

<div style="display: flex; align-items: center;"> <div style="margin-right: 20px;"> <p><b>Example</b></p>  </div> <div> <pre><b>* . IDENTIFY</b> A, B, C, D, E * Where A ...  SSD Manufacturer B ...  SSD Model C ...  SSD Serial Number</pre> </div> </div>
---

D ...	RMM Firmware Version
E ...	SSD Firmware Version

### 6.5.3.2 .MEDIA P

The .MEDIA P command is utilized to query the RMM for information regarding the physical block architecture of the SSD and the SCSI RECEIVE transfer limits in effect when reading physical blocks.

- Parameters

The parameter “P” distinguishes this command from the standard .MEDIA command.

- Response

The RMM responds with one line containing the tag “PHYSICAL” and five space-separated integer numbers. Response time shall be within 100 ms. A .STATUS command prior to 100 ms shall return a BUSY state.

#### Example

\* .MEDIA P

PHYSICAL A B C D E

\*

A = Physical block size in bytes. This value must be a multiple of item D below.

B = Total number of physical blocks in SSD.

C = Maximum operation request block (ORB) transfer size that can be used when reading the binary data from the physical block with the .BBREAD D and .PBWRITE D commands.

D = Number of valid data bytes in a physical page. Item A above must be an integer multiple of this value.

E = This field specifies the number of filler bytes appended onto each physical page read from the RMM. Filler bytes are typically inserted to pad the transfer to the next Advanced Technology Attachment sector boundary. If no padding is required, this field may be 0.

### 6.5.3.3 .SANITIZE

A .SANITIZE command shall initiate a write/verify of all RMM user data physical blocks. The pattern may consist of either all FFs or all 00s. The .SANITIZE command shall identify any blocks that cannot be written or verified. Blocks that cannot be written to or contain at least one bit that is stuck in either the 0 or the 1 state are termed bad blocks. The user shall review the block contents and map out the bad blocks such that they are no longer addressable. Once the address has been mapped out the blocks are no longer addressable and are no longer identified in the bad block table ([Figure 6-11](#)).



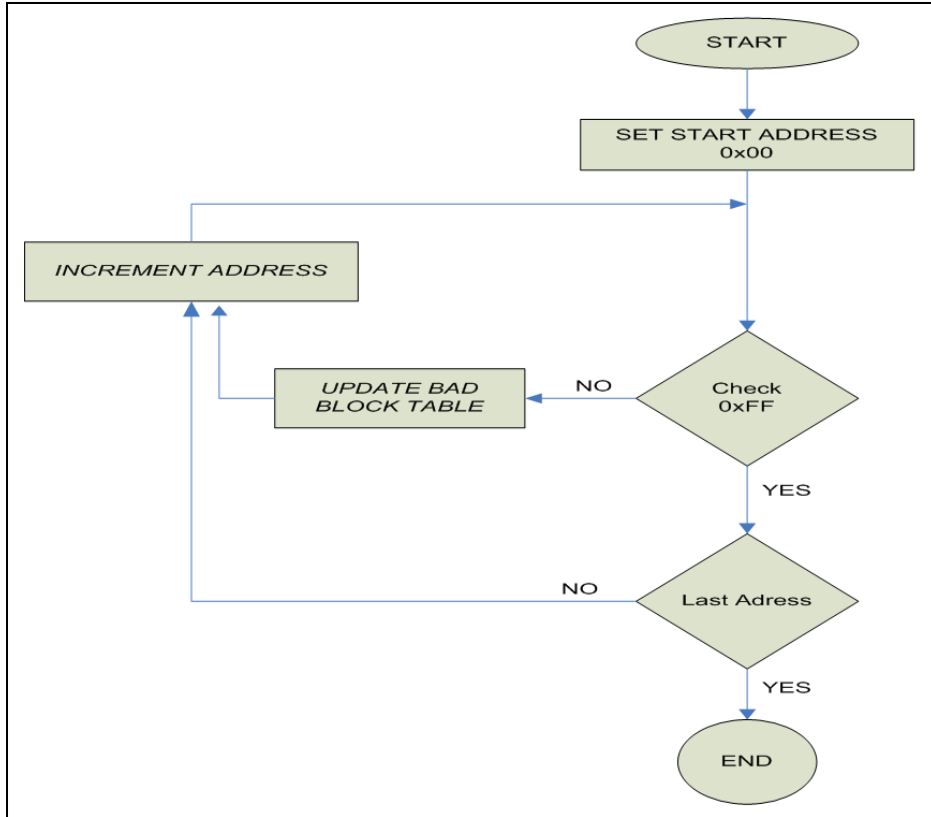

Figure 6-11. Updating the Bad Block Table

- Parameters

None

- Response

The RMM responds with an asterisk. Response time shall be within 100 ms. A .STATUS command prior to 100 ms shall elicit a BUSY response. During sanitization the RMM shall respond with “S 04 xx yy zz”; where zz indicates percentage complete. Upon completion a status response of “S 11 xx yy” shall indicate that bad blocks were found. A status response upon completion of “S 12 xx yy” shall indicate that no bad blocks were found.

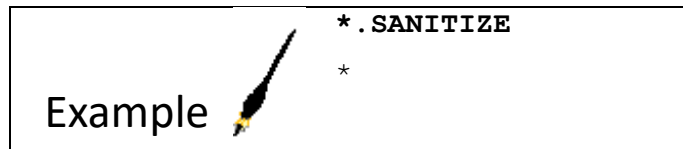

#### 6.5.3.4 .BBLIST

A .BBLIST command shall be utilized to instruct the RMM to retrieve the list of unsecured bad block identifiers from solid-state media residing in the RMM. A .BBLIST command is only valid following a .SANITIZE command.

- Parameters

None

- Response

The RMM responds with an asterisk. Response time shall be within 100 ms. A .STATUS command prior to 100 ms shall return a BUSY state.

<p>Example </p>	*.BBLIST
	*

### 6.5.3.5 .BBLIST R

A .BBLIST R command shall be used to retrieve bad block identifiers from the RMM. This command may only be issued immediately following a successful .BBLIST command.

- Parameters

The parameter “R” distinguishes this command from the standard .BBLIST command.

- Response

The RMM must respond with a list of hexadecimal bad block identifiers. Each identifier must be terminated with a <CR><LF> sequence. Each identifier must be a legal hexadecimal number from 1 to 16 digits. No embedded spaces or other special characters are allowed. Response time shall be within 100 ms. A .STATUS command prior to 100 ms shall return a BUSY state.

<p>Example </p>	*.BBLIST R
	000000E3
	0000034f
	FE0184C9
	*

### 6.5.3.6 BBREAD P {block\_identifier}

A .BBREAD P {block\_identifier} command shall direct the RMM to initiate a physical block read of the specified physical block identifier.

- Parameters

The parameter “P” distinguishes this as a binary physical block read command.

The parameter block\_identifier is the physical block identifier from the BBLIST R response of the block to be read.

- Response

The RMM responds with an asterisk. Response time shall be within 100 ms. A .STATUS command prior to 100 ms shall return a BUSY state.

<p>Example </p>	.BBREAD P FE0184C9
	*

### 6.5.3.7 .BBREAD D

A .BBREAD D command shall read one binary physical block from the RMM. This command may only be issued immediately after a successful .BBREAD P command. The physical block size, page size, page filler size, and maximum SCSI receive transfer size that are required to perform the transfer are all specified in the RMM's response to the .MEDIA P command.

- Parameters

None.

- Response

The RMM responds by returning the requested binary physical block data. Multiple SCSI receive commands may be required to retrieve the entire physical data block.

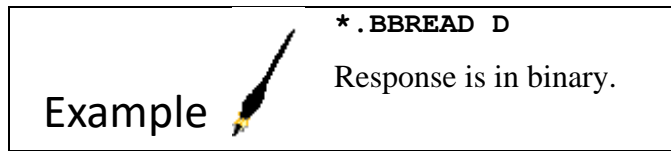

### 6.5.3.8 .BBSECURE {block identifier}

A .BBSECURE command shall be utilized to mark an unsecured bad block as being secured. A block that has been identified as secured shall never be used for any subsequent data recording. Secured bad blocks shall be removed from the unsecured bad block identifier list. The block identifier shall be provided for the block to be secured.

- Parameters

The parameter block\_identifier is the physical block identifier from the .BBLIST R response of the block to be secured.

- Response

The RMM responds with an asterisk.

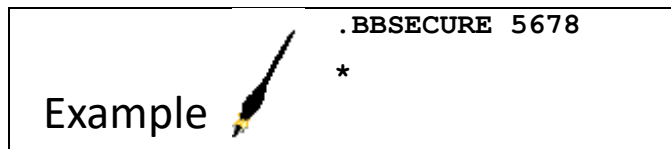

### 6.5.3.9 .PBWRITE P {block\_identifier}

A .PBWRITE P {block\_identifier} command shall direct the RMM to initiate a physical block write of the specified physical block identifier.

- Parameters

The parameter block\_identifier is the physical block identifier from the BBLIST R response of the block to be written.

- Response

The RMM responds with an asterisk. Response time shall be within 100 ms. A .STATUS command prior to 100 ms shall return a BUSY state.

<p>Example </p>	<pre>.PBWRITE P FE0184C9</pre>
	<pre>*</pre>

6.5.3.10 .PBWRITE D

A .PBWRITE D command shall write one binary physical block to the RMM. This command may only be issued immediately after a successful .PBWRITE P command. The size of the physical block transfer size and the maximum SCSI send page size required to perform the transfer are all specified in the RMM’s response to the .MEDIA P command.

- Parameters
 

Binary data block. Multiple SCSI send commands may be required to transfer the entire physical data block.
- Response
 

The RMM responds with an asterisk after all data is successfully received.

<p>Example </p>	<pre>*.PBWRITE D</pre>
	<pre>&lt;binary data&gt; total length = physical block size.</pre>

6.5.3.11 .INITIALIZE

A .INITIALIZE command shall be utilized to configure the RMM memory and reset of the firmware.

- Parameters
 

None
- Response
 

The RMM responds with an asterisk. Response time shall be within 100 ms. A .STATUS command prior to 100 ms shall return a BUSY state. A response of “S13 xx yy zz”; where zz indicates percentage complete shall be provided. Upon completion, a response of “S 14 xx yy” shall be provided; where yy indicates number of seconds required after initialization.

<p>Example </p>	<pre>*.INITIALIZE</pre>
	<pre>*</pre>
	<pre>.STATUS</pre>
	<pre>S 13 00 00 01%</pre>
	<pre>.STATUS</pre>
	<pre>S 13 00 00 02%</pre>

```

•
. STATUS
S 13 00 00 100%
. STATUS
S 14 00 03
. STATUS
S 01 00 00
    
```

6.5.3.12 .DECLASSIFY

A .DECLASSIFY command shall be utilized to initiate user procedures.

- Parameters  
None
- Response

The RMM responds with an asterisk. Response time shall be within 100 ms. A .STATUS command prior to 100 ms shall return a BUSY state. During sanitization the RMM shall respond with “S 04 xx yy zz”; where zz indicates percentage complete. Upon completion a status response of “S 11 xx yy” shall indicate that bad blocks were found. A status response upon completion of “S 12 xx yy” shall indicate that no bad blocks were found.

```

Example  * .DECLASSIFY
*
    
```

6.5.3.13 .IRIG106

A .IRIG106 command shall be utilized to retrieve the RCC 106-supported version number.

- Parameters  
None
- Response

The RMM responds with a version number that shall be a two-integer value representing the last two digits of the year of RCC 106 release supported by the device. Response time shall be within 100 ms. A .STATUS command prior to 100 ms shall return a BUSY state.

```

Example  * .IRIG106
09
*
    
```

6.5.3.14 .STATUS

A .STATUS command shall be utilized to query the RMM for status information (see [Table 6-15](#)).

- Description  
This command queries the RMM for status information.
- Parameters  
None
- Response

The RMM response to a .STATUS command is of the form:

Example 	<b>* .STATUS</b>				
	S	A	B	C	[D%]
	*				

<b>Table 6-15. Removable Memory Module States</b>				
State	Description			
	State Code (A)	State Value (B)	State Value (C)	Progress Percentage (D)
FAIL	00			
IDLE	01	00	00	
BIT	02	00	00	Percent Complete
ERASE	03	00	00	Percent Complete
DECLASSIFY SANITIZE	04	00	00	Percent Complete
BUSY	09	00	00	
SANITIZE COMPLETED BAD BLOCKS FOUND	11	00	Number of bad blocks found (Integer)	
SANITIZE COMPLETED NO BAD BLOCKS FOUND	12	00	00	
INITIALIZE IN PROGRESS	13	00	00	Percent Complete
INITIALIZE COMPLETE	14	00	Number of seconds required for initialization (Integer)	

6.5.3.15 RMM Command Error Codes

Issuing invalid commands (bad syntax) or illegal commands (not accepted in the current system state) results in error code responses (with an ASCII “E” identifier) prior to the asterisk response terminator when a command cannot be completed. [Table 6-16](#) shows possible error codes and the conditions under which they occur.

<b>Table 6-16. Command Error Codes</b>		
<b>Error</b>	<b>Description</b>	<b>Condition*s</b>
00	INVALID COMMAND	Command does not exist
01	INVALID PARAMETER	Parameter is out of range, or wrong alpha-numeric type
02	INVALID MODE	Command cannot be executed in the current state
05	COMMAND FAILED	Command failed to execute for any reason other than those listed above



6.5.4 SCSI and iSCSI Commands.

The mandatory SCSI command set for vendor-specific devices is as follows. Note that the SCSI standard imposes additional requirements for a device to be compliant.

- a. For random-access devices:

INQUIRY  
 READ  
 READ CAPACITY  
 REQUEST SENSE  
 TEST UNIT READY

- b. For sequential-access devices:

INQUIRY  
 READ  
 REWIND  
 TEST UNIT READY  
 REQUEST SENSE

6.5.5 Mandatory ORB Formats for the Processor Device Using IEEE 1394b

6.5.5.1 Minimum Operational Requirements

The time setting accuracy of the real-time clock device should be better than 1 ms. The short time accuracy of the real-time clock device must be better than 10 parts per million (ppm) in the temperature range 0-40°C and better than 50 ppm in the temperature range -40°C - +85°C.

6.5.5.2 IEEE 1394b ORB Format.

- a. Login ORB format. The login ORB format is illustrated in [Figure 6-12](#).

Most significant bit (msb)											Least significant bit (lsb)											
31	30	29	28	27	24	23	20	19	16	15	0											
Password																						
Login_response																						
n	Rq_fmt		x	Reserved				Reconnect				Function				LUN						
password_length											login_response_length											
Status_FIFO																						

Figure 6-12. Login ORB Format

- Password. In this 32-bit field, the password shall be “RTC.” The password field shall contain the immediate data and the password\_length shall be zero.
  - Login\_response. 32 bits.
  - login\_response\_length. 16 bits.
    - The Login\_response field and login\_response\_length fields shall specify the address and size of a buffer (minimum of 12 bytes) allocated by the host for the return of the login response.
  - n. In this one-bit field, the notify bit “n” shall be one.
  - Rq\_fmt. In this two-bit field, the rq\_fmt shall be zero.
  - x. In this one-bit field, the exclusive bit “x” shall be one.
  - Reserved. A four-bit field, Reserved shall be zero.
  - Reconnect. The four-bit reconnect field shall specify the reconnect time as a power of 2 seconds. A value of zero shall mean one second.
  - Function. This field is four bits. The function shall be zero.
  - LUN. This is 16 bits. The LUN shall be one.
  - Status\_FIFO. The 64-bit Status\_FIFO shall contain the address allocated by the host for the return of status for the login request and for the return of subsequent write and read buffer response(s) indicating success/failure of the operation.
- b. Login Response. The login response format is illustrated in [Figure 6-13](#).

msb																lsb						
31															16	15	0					
Length																login_ID						
command_block_agent																						
reserved																reconnect_hold						

Figure 6-13. Login Response Format

- Length. This 16-bit field contains the length, in bytes, of the login response data.
- login\_ID. This 16-bit field is used in all subsequent requests to the SCSI multimedia command’s management agent.



- command\_block\_agent. This is a 64-bit field that contains the base address of the agent’s control and status register.
  - Reserved. This 16-bit field shall be zero.
  - Reconnect\_hold. This 16-bit field is to be defined.
- c. Send. The send command ORB format is illustrated in [Figure 6-14](#), and the send data buffer format is illustrated in [Figure 6-15](#). The send data buffer contains the send command with the carriage return, line feed, and binary 0 character terminated. Alternatively, a .PBWRITE D command will send data in binary format.

msb															lsb		
31	30	29	28	27	26	24	23	21	20	19	18	17	16	15	8	7	0
next_ORB																	
data_descriptor																	
n	Rq_fmt		r	d	Spd			max_payload		p	page_size			data size			
0Ah							LUN		Res			AEN		Xfer Lng - upper bits			
Xfer Lng - lower bits							Control					00h		00h			
00h							00h					00h		00h			

Figure 6-14. Send Command ORB Format

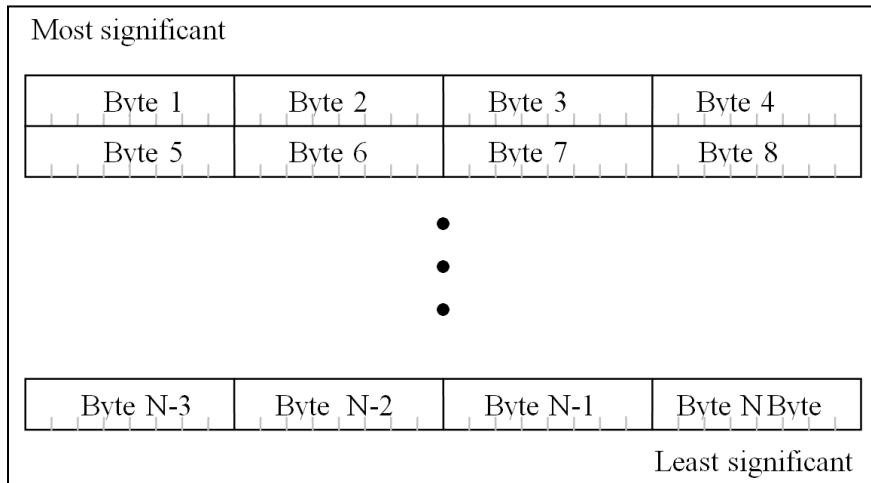

Figure 6-15. Send Data Buffer Format

- next\_ORB. This 64-bit field contains the ORB pointer format, which shall be IAW SBP-2 specifications.
- data\_descriptor. The 32-bit data\_descriptor field shall contain the address of the data buffer.
- n. The completion notification “n” in this one-bit field shall be one. The target shall store a status block at the Status\_FIFO address at the address supplied in the login request.
- Rq\_fmt. Required format in this two-bit field shall be zero.
- r. Reserved in this one-bit field shall be zero.

- d. Direction bit in this one-bit field shall be zero.
- spd. This is a three-bit field that contains speed, which shall have a value of two.
- max\_payload. A four-bit field, the maximum data transfer length shall be nine.
- p. This is a one-bit field. The RMM must be prepared to handle the page table bit p=0 and p=1 cases, as the standard operating systems set this bit without influence of the application process.
- page\_size. This is three bits. Page size shall be zero if the p field is set to 0; otherwise this field shall be set to the valid page size.
- data\_size. This is 16 bits. The data size field should be set according to the allocated send buffer size in bytes (N). The length must be at least 80 (0x50).
- LUN. The LUN shall be one in this three-bit field.
- Res. This is a four-bit field. Reserved shall be zero.
- AEN. In this one-bit field, AEN shall be zero.
- Xfer Lng. This is 24 bits. The length must be at least 80 (0x50).
- Control. In this 8-bit field, control shall be 128.

d. Receive. The receive command block ORB format is illustrated in [Figure 6-16](#).

msb																						lsb
31	30	29	28	27	26	24	23	21	20	19	18	17	16	15	8	7	0					
next_ORB																						
data_descriptor																						
n	Rq_fmt		r	d	spd			max_payload			p	page_size			data_size							
0Ah							LUN			Res			AEN	Xfer Lng - upper bits								
Xfer Lng - lower bits							Control							00h	00h							
00h							00h							00h	00h							

Figure 6-16. Receive Command Block ORB Format

- next\_ORB. This 64-bit field contains the ORB pointer format, which shall be IAW SBP-2 specifications.
- data\_descriptor. The 32-bit data\_descriptor field shall contain the address of the data buffer.
- n. The completion notification “n” in this one-bit field shall be one. The target shall store a status block in the Status\_FIFO field at the address supplied in the login request.
- Rq\_fmt. Required format in this two-bit field shall be zero.
- r. Reserved in this one-bit field shall be zero.
- d. Direction bit in this one-bit field shall be zero.
- spd. This is a three-bit field that contains speed, which shall have a value of two.

- max\_payload. A four-bit field, the maximum data transfer length shall be nine.
- p. This is a one-bit field. The RMM must be prepared to handle the page table bit  $p=0$  and  $p=1$  cases, as the standard operating systems set this bit without influence of the application process.
- page\_size. This is three bits. Page size shall be zero if the  $p$  field is set to 0; otherwise this field shall be set to the valid page size.
- data\_size. This is 16 bits. The data size field should be set according to the allocated send buffer size in bytes (N). The length must be at least 80 (0x50).
- LUN. The LUN shall be one in this three-bit field.
- Res. This is a four-bit field. Reserved shall be zero.
- AEN. In this one-bit field, AEN shall be zero.
- Allocation\_Lng. This is 24 bits. Allocation\_Lng = length of the Chapter 6 response string.
- Control. In this 8-bit field, control shall be 128.

The receive data buffer can be returned in ASCII format (see [Figure 6-17](#)) or in binary format (see [Figure 6-18](#)) if the retrieved data contains binary information. Multiple ORBs may be used to retrieve the data required.

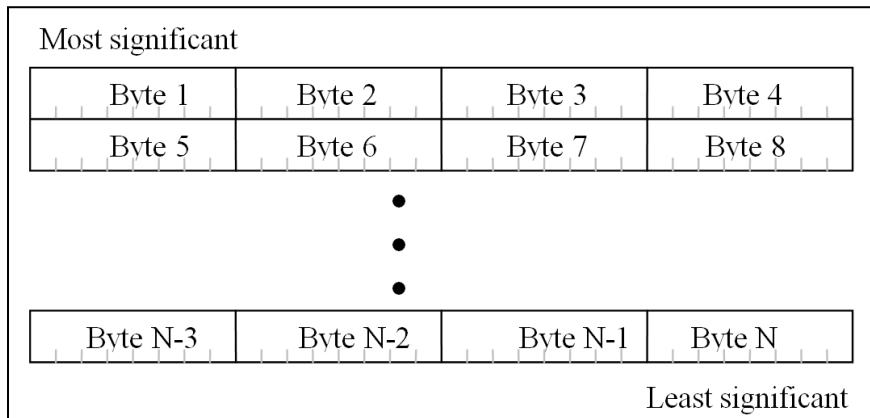

Figure 6-17. Receive Data Buffer Format ASCII Format

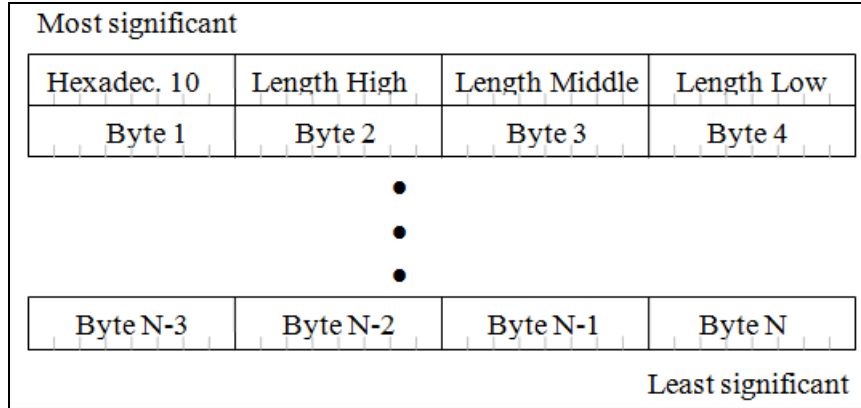

Figure 6-18. Receive Data Buffer Binary Format

- The returned remote answer is an ASCII text terminated by the “\*” character IAW Section 6.2. If the “\*” terminator is missing, multiple receive commands must be used to retrieve the data until the “\*” terminator is received.
- The returned remote answer can contain mixed ASCII text or binary information until the specified length in the first 32-bit word. The first byte is a hexadecimal 10 code to identify the binary format (codes hexadecimal 11-1F are reserved for future extensions). The answer must be terminated by the “\*” character IAW Subsection 6.2.1. If the “\*” terminator is missing, multiple receive commands must be used to retrieve the data until the “\*” terminator is received.

### 6.5.6 Additional Mandatory Commands When Using Ethernet

#### 6.5.6.1 .MEDIA E

The .MEDIA E command is utilized to query the RMM for information regarding which of the data access protocols is supported.

- Parameters

The parameter “E” distinguishes this command from the standard .MEDIA command.

- Response

The RMM responds with one line containing the tag “PROTOCOLS” and at least one of the tags “FTP”, “ISCSI”, and “PTP” in alphabetical order each separated by a space. Response time shall be within 100 ms. A .STATUS command prior to 100 ms may return a BUSY state.

- Example

\*.MEDIA E

PROTOCOLS FTP PTP

\*

#### 6.5.6.2 .RMMIP

The .RMMIP command shall be utilized to display RMM IP address and addressing mode.

- Parameters  
None
- Response  
The RMM responds with one line containing the tag “IP\_ADDRESS”, either the tag “STATIC” or “DHCP”, and three space-separated “dotted quad” IPv4 addresses, representing the IP address of the RMM, the net mask associated with that address, and the default gateway for the network associated with the net mask. If Dynamic Host Control Protocol (DHCP) is being used and no DHCP address has been obtained, all three address fields shall be set to 0.0.0.0. Response time shall be within 100 ms. A .STATUS command prior to 100 ms may return a BUSY state.
- Examples  
\*.RMMIP  
IP\_ADDRESS STATIC 10.6.9.2 255.0.0.0 10.6.9.1  
\*.RMMIP  
IP\_ADDRESS DHCP 192.168.2.1 255.255.255.0 192.168.2.254  
\*.RMMIP  
IP\_ADDRESS DHCP 0.0.0.0 0.0.0.0 0.0.0.0  
\*

#### 6.5.6.3 .RMMIP keyword [parameters]

The .RMMIP command shall be utilized to control RMM IP address and addressing mode.

- Keywords  
DHCP - used to set the RMM to DHCP mode.  
RESET - used to reset the Ethernet RMM to defaults, including IP addresses, frame size, and login passwords.  
xxx.xxx.xxx.xxx - used to set the RMM to static mode with the indicated IPv4 address; requires parameters. “xxx” indicates any number between 0 and 255.
- Parameters  
NetMask Gateway- used to specify the net mask for the static IP address and the default gateway for the network associated with the net mask. Each has the form xxx.xxx.xxx.xxx
- Response  
The RMM responds with an asterisk. Response time shall be within 100 ms. A .STATUS command prior to 100 ms may return a BUSY state.
- Examples  
.RMMIP DHCP

\*

.RMMIP RESET

\*

.RMMIP 192.168.10.99 255.255.255.0 192.169.10.254

\*

#### 6.5.6.4 .TIME PTP

A .TIME PTP command shall be used to initiate the process of synchronizing the RMM real-time clock with an IEEE-1588 network time source. Note that successful synchronization with a time source will implicitly set the date as well as the time.

- Parameters

The parameter “PTP” distinguishes this command from the standard .TIME command.

- Response

The RMM responds with an asterisk. Response time shall be within 100 ms. A .STATUS command prior to 100 ms may return a BUSY state.

#### 6.5.6.5 .TIME PTPSTATUS

A .TIME PTPSTATUS command shall be used to report the state of synchronization between the RMM real-time clock and an IEEE-1588 network time source.

- Parameters

The parameter “PTPSTATUS” distinguishes this command from the standard .TIME command.

- Response

The RMM responds with one line containing one of the words “LOCKED” or “NONE”, followed by an asterisk on a new line. “NONE” indicates that no sync has been obtained; “LOCKED” indicates that the RMM’s clock has been synchronized with a network clock. Response time shall be within 100 ms. A .STATUS command prior to 100 ms may return a BUSY state.

#### 6.5.6.6 .TMATS GET

A .TMATS GET command shall be used to transfer the contents of the RSCF on the RMM media into a volatile buffer. No additional parameter is required, and if one is specified it shall be ignored.

- Parameters

The parameter “GET” distinguishes this command from other .TMATS commands.

- Response

The RMM responds with an asterisk. If no valid RSCF IAW [Chapter 10](#) Subsection 10.3.8.1 is located on the RMM media, an error is returned and the volatile buffer is erased. A .STATUS command prior to 100 ms may return a BUSY state.

#### 6.5.6.7 .TMATS READ

A .TMATS READ command shall be used to display the contents of the volatile buffer created by either a .TMATS GET or a .TMATS WRITE command for the RSCF.

- Parameters  
The parameter “READ” distinguishes this command from other .TMATS commands.
- Response  
The RMM responds by displaying the contents of the volatile buffer followed by a line containing an asterisk. If the buffer contains no RSCF, no error shall be returned.

#### 6.5.6.8 .TMATS SAVE n

A .TMATS SAVE command shall be used to transfer the contents of the volatile buffer created by a .TMATS WRITE command to the media. If the media already contains any data (except for a previous RSCF), an error shall be returned. The created file shall be IAW [Chapter 10](#) Subsection 10.3.8.1.

- Parameters  
The parameter “SAVE” distinguishes this command from other .TMATS commands. The number following is used to generate the file name of the RSCF, “recorder\_configuration\_file\_SAVE\_n”.
- Response  
The RMM responds with an asterisk. A .STATUS command prior to 100 ms may return a BUSY state.

#### 6.5.6.9 .TMATS WRITE

A .TMATS WRITE command shall be used to transfer a TMATS file to the RMM for subsequent use as an RSCF.

- Parameters  
The parameter “WRITE” distinguishes this command from other .TMATS commands.
- Response  
The RMM responds by entering TMATS data transfer mode. All data sent to the RMM will be added to a volatile buffer until a line with the single word “END” is received, following which the RMM responds with an asterisk.

### 6.5.7 Additional Non-Mandatory Commands When Using Ethernet.

#### 6.5.7.1 .RMMFRAME

The .RMMFRAME command shall be utilized to display the current and maximum values for the Ethernet frame size or maximum transmission unit (MTU).

- Parameters  
None

- Response

The RMM responds with one line containing two integers separated by a “/”. The first integer indicates the currently configured frame size (default: 1500 bytes), and the second is the largest frame size supported by the RMM.

- Example

\*.RMMFRAME

1500/9200

\*.RMMFRAME

1500/1500

\*.RMMFRAME

1300/9000

 <b>NOTE</b>	An RMM command error code of 00 (“Invalid Command”) shall be interpreted to mean that the default value of 1500 bytes only is supported, and thus is synonymous with a response of “1500/1500”.
---	---

#### 6.5.7.2 .TCPPOPTS ffff

A .TCPPOPTS command with a parameter of an integer shall be used to configure the Ethernet frame size or MTU to be used.

- Parameters

ffff where ffff is the value to be used.

- Response

The RMM responds with an asterisk. A .STATUS command prior to 100 ms may return a BUSY state.

Once the RMM has responded, all devices connecting to the RMM shall adjust their own frame size settings to match the new setting.

- Example

\*.RMMFRAME 9000

\*

#### 6.5.7.3 .TCPPOPTS

The .TCPPOPTS command shall be utilized to display the port numbers used for the network services (Telnet, FTP, iSCSI).

- Parameters

None



- Response  
The RMM responds with one line containing three comma-separated integers between 0 and 65535. The first integer indicates the port at which the Telnet server is listening, the next is the port used by the FTP server, and the third is for iSCSI. If an RMM does not support one of the two data access methods, it may report “0”.
- Example  
\*.TCPPORTS  
923,921,3260  
\*.TCPPORTS  
923,0,3260  
\*.TCPPORTS  
928,921, 0

 <p><b>NOTE</b></p>	<p>Note: a response of “0,0,0” or an RMM command error code of 00 (“Invalid Command”) shall be interpreted to mean that the default ports are being used, and thus is synonymous with a response of “923,921,3260”.</p>
--	---

#### 6.5.7.4 .TCPPORTS ppp,qqq,rrr

A .TCPPORTS command with a parameter of three comma-separated integers between 0 and 65535 shall be used to configure TCP ports used by each of the three services defined for Ethernet RMM devices.

- Parameters  
ppp,qqq,rrr where ppp is the port to be used for the Telnet service, qqq is the port to be used for the FTP service, and rrr is the port to be used for iSCSI. A value of “0” in any one of the positions indicates that the current port configuration for that service is not to be changed.
- Response  
The RMM responds with an asterisk. A .STATUS command prior to 100 ms may return a BUSY state.  
If the port for the Telnet service is changed, the RMM may unilaterally disconnect (close the Telnet TCP connection) following the asterisk. The currently configured Telnet port shall be accessible by means of the Service Location Protocol IAW [Chapter 10](#) Subsection 10.9.3.2 item c.
- Example  
\*.TCPPORTS 923,921,3260  
\*

This page intentionally left blank.

## APPENDIX 6-A

**MIL-STD-1553 Remote Terminal Command and Control**

The MIL-STD-1553 implementation of Chapter 6 commands complies with typical bus controller (BC) operation. Typically, C&C receive messages are aperiodic and are only issued when specific R/R action is required by the BC. The C&C transmit messages are periodic and report status back to the BC.

**A.1. Receive Messages**

[Table A-1](#) provides a description of the MIL-STD-1553 receive commands defined in the following sections.

<b>Table A-1. Military Standard 1553 Receive (Bus Controller to Remote Terminal) Command Set</b>		
<b>Command</b>	<b>Subaddress</b>	<b>Description</b>
ASSIGN	1	Selects the input channel to be replayed
BIT	1	Runs all of the built-in tests
ERASE	1	Erases the recording media
EVENT	1	Marks an event
INFO	1	Requests detailed information regarding a specific file or event (see INFO Transmit Command in <a href="#">Table A-2</a> )
PAUSE	1	Pauses recording of all or specific channels
REPLAY	1	Controls the replay of recorded data
PUBLISH	1	Configures/controls Ethernet interface
QUEUE	1	Sets the replay point in the recorded data to a file or event
RECORD	1	Starts a recording at the current end of data
RESET	1	Performs software-initiated system reset
RESUME	1	Resumes recording of paused channels
SANITIZE	1	Secure-erases the recording media
STOP	1	Stops the current recording, playback, or both
TIME	1	Sets the internal system time

**A.1.a. Receive Message Length**

All R1 (subaddress 1) command (receive) messages have 32 data words. All unused data words are zero-filled. If the R/R receives an improperly formed BC to remote terminal (RT) message (length error, parity error, etc.) it will respond with an error status word (the last word of a BC-to-RT transaction) and the message will be ignored by the R/R control program. The acceptability of any properly formed BC-to-RT message received by the R/R is determined by the content of the message and the state of the R/R when the message is received, as identified in this standard. The R2 (subaddress 2) command (receive) message has 1 data word.

A.1.b. Assign Command

The Assign command is used to specify the desired channel for replay operations (see Replay command below.)

MESSAGE NAME: Assign

MESSAGE ID:	R1-001	TRANSFER TYPE:	BC-RT
SOURCE:	BC	WORD COUNT:	32
DESTINATION:	R/R		

WORD NAME	WORD NO.	DESCRIPTION
Command Word	CW	Subaddress 00001 binary
Assign Command ID	01	ID of Assign command = 0x0001
Output Channel Number	02	Output Channel
Input Channel Number	03	Input Channel to be replayed
Zero	4-32	Zero-filled
Status Word	SW	MIL-STD-1553 Status Word

WORD NAME: Assign Command ID

WORD ID:	R1-001-01	RANGE:	N/A
SOURCE:	BC	ACCURACY:	N/A
DESTINATION:	R/R	lsb:	N/A
XMIT RATE	Aperiodic		
SIGNAL TYPE	Discrete		
UNITS	N/A		

BIT NO.	DESCRIPTION
0 msb	-----
1	Hex Digit #1 = 0
2	
3 lsb	-----
4 msb	-----
5	Hex Digit #2 = 0
6	
7 lsb	-----
8 msb	-----
9	Hex Digit #3 = 0
10	
11 lsb	-----
12 msb	-----
13	Hex Digit #4 = 1
14	
15 lsb	-----

WORD NAME: Output Channel Number

WORD ID:	R1-001-02	RANGE:	N/A
SOURCE:	BC	ACCURACY:	N/A
DESTINATION:	R/R	lsb:	N/A
XMIT RATE	Aperiodic		
SIGNAL TYPE	Discrete		
UNITS	N/A		

BIT NO.		DESCRIPTION
0	msb	-----
1		Hex Digit #1
2		
3	lsb	-----
4	msb	-----
5		Hex Digit #2
6		
7	lsb	-----
8	msb	-----
9		Hex Digit #3
10		
11	lsb	-----
12	msb	-----
13		Hex Digit #4
14		
15	lsb	-----

WORD NAME: Input Channel Number

WORD ID:	R1-001-03	RANGE:	N/A
SOURCE:	BC	ACCURACY:	N/A
DESTINATION:	R/R	lsb:	N/A
XMIT RATE	Aperiodic		
SIGNAL TYPE	Discrete		
UNITS	N/A		

BIT NO.		DESCRIPTION
0	msb	-----
1		Hex Digit #1
2		
3	lsb	-----
4	msb	-----
5		Hex Digit #2

```

6
7   lsb   -----
8   msb   -----
9           Hex Digit #3
10
11  lsb   -----
12  msb   -----
13           Hex Digit #4
14
15  lsb   -----
    
```

A.1.c. BIT Command

The BIT command is used to start an initiated built-in test (IBIT). While in the BIT state, the percent complete is output via the STATUS transmit command. When the IBIT completes, the state of the R/R as returned by the STATUS transmit command indicates either “IBIT Pass” (state = IDLE) or “IBIT Fail” (state = FAIL). Additional failure details may be obtained from the HEALTH transmit command response. An IBIT requires no more than 10 seconds to complete.

MESSAGE NAME: BIT

MESSAGE ID: R1-002    TRANSFER TYPE: BC-RT  
 SOURCE:        BC    WORD COUNT:    32  
 DESTINATION: R/R

WORD NAME	WORD NO.	DESCRIPTION
Command Word	CW	Subaddress 00001 binary
BIT Command ID	01	ID of Assign command = 0x0002
Zero	2-32	Zero-filled
Status Word	SW	MIL-STD-1553 Status Word

WORD NAME:    BIT Command ID

WORD ID:        R1-002-01            RANGE:            N/A  
 SOURCE:        BC                    ACCURACY:        N/A  
 DESTINATION:   R/R                    lsb:              N/A  
 XMIT RATE      Aperiodic  
 SIGNAL TYPE     Discrete  
 UNITS           N/A

```

BIT NO.                    DESCRIPTION

0    msb    -----
1            Hex Digit #1 = 0
    
```

```

2
3   lsb   -----
4   msb   -----
5         Hex Digit #2 = 0
6
7   lsb   -----
8   msb   -----
9         Hex Digit #3 = 0
10
11  lsb   -----
12  msb   -----
13        Hex Digit #4 = 2
14
15  lsb   -----
    
```

A.1.d. Erase Command

The Erase command is used to erase internal recording drive or RMM installed in the R/R. While in the Erase state, the percent complete is output via the STATUS transmit command.

MESSAGE NAME: Erase

MESSAGE ID: R1-004    TRANSFER TYPE: BC-RT  
 SOURCE: BC    WORD COUNT: 32  
 DESTINATION: R/R

WORD NAME	WORD NO.	DESCRIPTION
Command Word	CW	Subaddress 00001 binary
Erase Command ID	01	ID of Erase command = 0x0004
Zero	2-32	Zero-filled
Status Word	SW	MIL-STD-1553 Status Word

WORD NAME: Erase Command ID

WORD ID: R1-004-01                      RANGE: N/A  
 SOURCE: BC                              ACCURACY: N/A  
 DESTINATION: R/R                      lsb: N/A  
 XMIT RATE Aperiodic  
 SIGNAL TYPE Discrete  
 UNITS N/A

```

BIT NO.                      DESCRIPTION
0   msb   -----
1         Hex Digit #1 = 0
    
```

```

2
3   lsb      -----
4   msb      -----
5           Hex Digit #2 = 0
6
7   lsb      -----
8   msb      -----
9           Hex Digit #3 = 0
10
11  lsb      -----
12  msb      -----
13          Hex Digit #4 = 4
14
15  lsb      -----
    
```

A.1.e. Event Command

The Event command is used to mark a specific event occurrence with the insertion of a Chapter 10 event packet in the recording file. The BC programmer can define up to 31 events numbered 1 to 31 in the TMATS packet that is loaded into the recorder from the RMM and written as the first packet in each data file.

MESSAGE NAME: Event

MESSAGE ID: R1-005    TRANSFER TYPE: BC-RT  
 SOURCE: BC    WORD COUNT: 32  
 DESTINATION: R/R

WORD NAME	WORD NO.	DESCRIPTION
Command Word	CW	Subaddress 00001 binary
Event Command ID	01	ID of Event command = 0x0005
Event Number	02	1-origin number of a defined event
Zero	3-32	Zero-filled
Status Word	SW	MIL-STD-1553 Status Word

WORD NAME: Event Command ID

WORD ID: R1-005-01                      RANGE: N/A  
 SOURCE: BC                              ACCURACY: N/A  
 DESTINATION: R/R                      lsb: N/A  
 XMIT RATE Aperiodic  
 SIGNAL TYPE Discrete  
 UNITS N/A

BIT NO.                              DESCRIPTION



0	msb	-----
1		Hex Digit #1 = 0
2		
3	lsb	-----
4	msb	-----
5		Hex Digit #2 = 0
6		
7	lsb	-----
8	msb	-----
9		Hex Digit #3 = 0
10		
11	lsb	-----
12	msb	-----
13		Hex Digit #4 = 5
14		
15	lsb	-----

WORD NAME	Event Number		
WORD ID:	R1-005-02	RANGE:	N/A
SOURCE:	BC	ACCURACY:	N/A
DESTINATION:	R/R	lsb:	N/A
XMIT RATE	Aperiodic		
SIGNAL TYPE	Discrete		
UNITS	N/A		

BIT NO.		DESCRIPTION
0	msb	-----
1		Hex Digit #1 = 0
2		
3	lsb	-----
4	msb	-----
5		Hex Digit #2 = 0
6		
7	lsb	-----
8		Binary 0
9		Binary 0
10		Binary 0
11	msb	-----
12		
13		5-bit binary event number from 1 to N where N is the number of defined
14		BC events in the R/R setup record.
15	lsb	-----

A.1.f. Info (receive) Command

The Info receive command is used to specify the desired information to be returned to the BC from the R/R by the Info transmit command (see Paragraph [A.2.d](#)).

MESSAGE NAME: Info (receive)

MESSAGE ID: R1-007 TRANSFER TYPE: BC-RT  
 SOURCE: BC WORD COUNT: 32  
 DESTINATION: R/R

WORD NAME	WORD NO.	DESCRIPTION
Command Word	CW	Subaddress 00001 binary
Info Command ID	01	ID of Info (receive) command = 0x0007
Info Type and Number	02	Info type and file or event number
Info Event Occurrence	03	Specific occurrence when type = event
Zero	4-32	Zero-filled
Status Word	SW	MIL-STD-1553 Status Word

WORD NAME: Info Command ID

WORD ID: R1-007-01 RANGE: N/A  
 SOURCE: BC ACCURACY: N/A  
 DESTINATION: R/R lsb: N/A  
 XMIT RATE Aperiodic  
 SIGNAL TYPE Discrete  
 UNITS N/A

BIT NO.	DESCRIPTION
0 msb	-----
1	Hex Digit #1 = 0
2	
3 lsb	-----
4 msb	-----
5	Hex Digit #2 = 0
6	
7 lsb	-----
8 msb	-----
9	Hex Digit #3 = 0
10	
11 lsb	-----
12 msb	-----
13	Hex Digit #4 = 7
14	
15 lsb	-----

WORD NAME Info Type and Number

WORD ID: R1-007-02 RANGE: N/A  
 SOURCE: BC ACCURACY: N/A  
 DESTINATION: R/R lsb: N/A  
 XMIT RATE Aperiodic  
 SIGNAL TYPE Discrete  
 UNITS N/A

BIT NO. DESCRIPTION

0 msb Bit 0 is the Info request type: 0 = file, 1 = event  
 1 Binary 0  
 2 Binary 0  
 3 Binary 0  
 4 Binary 0  
 5 Binary 0  
 6 Bit 6 - 15 is the unsigned binary integer file number  
 7 when Bit 0 = 0 or the unsigned binary integer  
 8 event number when Bit 0 = 1. Bit 6 is the msb  
 9 and Bit 15 is the lsb  
 10  
 11  
 12  
 13  
 14  
 15 lsb

WORD NAME: Info Event Occurrence

WORD ID: R1-007-03 RANGE: N/A  
 SOURCE: BC ACCURACY: N/A  
 DESTINATION: R/R lsb: N/A  
 XMIT RATE Aperiodic  
 SIGNAL TYPE Discrete  
 UNITS N/A

BIT NO. DESCRIPTION

0 msb Bit 0 - 15 is the unsigned integer event occurrence number of  
 1 the event specified in data word 2 bits 6-15 when Bit 0 of data  
 2 word 2 = 1, otherwise this data word 3 is unused (zero) when  
 3 Bit 0 of data word 2 = 0. Bit 0 is the msb and Bit 15 is the lsb  
 4  
 5

6  
 7  
 8  
 9  
 10  
 11  
 12  
 13  
 14  
 15    lsb

A.1.g. Pause Command

The Pause command is used to instruct the R/R to suspend recording of one or more channels, either by channel type or specific channel IDs.

MESSAGE NAME:   Pause

MESSAGE ID:   R1-008   TRANSFER TYPE:   BC-RT  
 SOURCE:       BC   WORD COUNT:       32  
 DESTINATION:  R/R

WORD NAME	WORD NO.	DESCRIPTION
Command Word	CW	Subaddress 00001 binary
Pause Command ID	01	ID of Pause command = 0x0008
Pause Condition	02	Channel group or individual channels
Pause Channel ID	03-16	Individual Channel ID or zero
Zero	17-32	Zero-filled
Status Word	SW	MIL-STD-1553 Status Word

WORD NAME:       Pause Command ID

WORD ID:         R1-008-01               RANGE:            N/A  
 SOURCE:         BC                      ACCURACY:        N/A  
 DESTINATION:   R/R                     lsb:             N/A  
 XMIT RATE       Aperiodic  
 SIGNAL TYPE     Discrete  
 UNITS           N/A

BIT NO.	DESCRIPTION
0    msb	-----
1	Hex Digit #1 = 0
2	
3    lsb	-----

4	msb	-----
5		Hex Digit #2 = 0
6		
7	lsb	-----
8	msb	-----
9		Hex Digit #3 = 0
10		
11	lsb	-----
12	msb	-----
13		Hex Digit #4 = 8
14		
15	lsb	-----

WORD NAME: Pause Condition

WORD ID:	R1-008-02	RANGE:	N/A
SOURCE:	BC	ACCURACY:	N/A
DESTINATION:	R/R	lsb:	N/A
XMIT RATE	Aperiodic		
SIGNAL TYPE	Discrete		
UNITS	N/A		

**BIT NO. DESCRIPTION**

0 msb Binary 0

Bits 1-3 are a three-bit code that specify the type of pause

Bit No.	123	
	000	= Individual Channel(s)
	001	= All Channels
		Remaining bits reserved

4		Binary 0
5		Binary 0
7		Binary 0
8		Binary 0
9		Binary 0
10		Binary 0
11		Binary 0
12		Binary 0
13		Binary 0
14		Binary 0
15	lsb	Binary 0

WORD NAME: Pause Channel ID

WORD ID:	R1-008-03 to R1-008-16	RANGE:	N/A
SOURCE:	BC	ACCURACY:	N/A
DESTINATION:	R/R	lsb:	N/A
XMIT RATE	Aperiodic		
SIGNAL TYPE	Discrete		
UNITS	N/A		

BIT NO.		DESCRIPTION
0	msb	Bit 0 - 15 is the unsigned integer Channel ID number of a channel to be paused when Bits 1-3 of data word 2 equal 110, otherwise these data words 3 to 16 are unused and zero-filled.
1		
2		
3		
4		
5		
6		
7		
8		
9		
10		
11		
12		
13		
14		
15	lsb	

A.1.h. Queue Command

The Queue command is used to specify a recorded data file or defined data event at which to begin the next replay. Replay must be stopped prior to issuing the Queue command.

MESSAGE NAME: Queue

MESSAGE ID:	R1-011	TRANSFER TYPE:	BC-RT
SOURCE:	BC	WORD COUNT:	32
DESTINATION:	R/R		

WORD NAME	WORD NO.	DESCRIPTION
Command Word	CW	Subaddress 00001 binary
Queue Command ID	01	ID of Queue command = 0x000B
Queue Mode/Number	02	Queue type and file or event number
Queue Event Occurrence	03	Specific occurrence when type = event
Zero	4-32	Zero-filled
Status Word	SW	MIL-STD-1553 Status Word

WORD NAME: Queue Command ID

WORD ID:	R1-011-01	RANGE:	N/A
SOURCE:	BC	ACCURACY:	N/A
DESTINATION:	R/R	lsb:	N/A
XMIT RATE	Aperiodic		
SIGNAL TYPE	Discrete		
UNITS	N/A		

BIT NO.		DESCRIPTION
0	msb	-----
1		Hex Digit #1 = 0
2		
3	lsb	-----
4	msb	-----
5		Hex Digit #2 = 0
6		
7	lsb	-----
8	msb	-----
9		Hex Digit #3 = 0
10		
11	lsb	-----
12	msb	-----
13		Hex Digit #4 = B
14		
15	lsb	-----

WORD NAME: Queue Mode/Number

WORD ID:	R1-011-02	RANGE:	N/A
SOURCE:	BC	ACCURACY:	N/A
DESTINATION:	R/R	lsb:	N/A
XMIT RATE	Aperiodic		
SIGNAL TYPE	Discrete		
UNITS	N/A		

BIT NO.		DESCRIPTION
0	msb	Bit 0 is the Queue request type: 0 = file, 1 = event
1		Binary 0
2		Binary 0
3		Binary 0
4		Binary 0

5 Binary 0  
 6 Bit 6 - 15 is the unsigned binary integer file number  
 7 when Bit 0 = 0 or the unsigned binary integer  
 8 event number when Bit 0 = 1. Bit 6 is the msb  
 9 and Bit 15 is the lsb  
 10  
 11  
 12  
 13  
 14  
 15 lsb

WORD NAME: Queue Event Occurrence

WORD ID:	R1-011-03	RANGE:	N/A
SOURCE:	BC	ACCURACY:	N/A
DESTINATION:	R/R	lsb:	N/A
XMIT RATE	Aperiodic		
SIGNAL TYPE	Discrete		
UNITS	N/A		

BIT NO.		DESCRIPTION
0	msb	Bit 0 - 15 is the unsigned integer event occurrence number of the event specified in data word 2 bits 6-15 when Bit 0 of data word 2 = 1, otherwise this data word 3 is unused (zero) when Bit 0 of data word 2 = 0. Bit 0 is the msb and Bit 15 is the lsb
1		
2		
3		
4		
5		
6		
7		
8		
9		
10		
11		
12		
13		
14		
15	lsb	

A.1.i. Record Command

The Record command is used to open a new file in the R/R internal memory or RMM file table and start recording data. While in the Record state or Record and Play state, the percent of drive filled (total minus remaining) is output via the STATUS transmit command.



MESSAGE NAME: Record

MESSAGE ID: R1-012 TRANSFER TYPE: BC-RT  
 SOURCE: BC WORD COUNT: 32  
 DESTINATION: R/R

WORD NAME	WORD NO.	DESCRIPTION
Command Word	CW	Subaddress 00001 binary
Record Command ID	01	ID of Record command = 0x000C
Zero	02-32	Zero-filled
Status Word	SW	MIL-STD-1553 Status Word

WORD NAME: Record Command ID

WORD ID: R1-012-01 RANGE: N/A  
 SOURCE: BC ACCURACY: N/A  
 DESTINATION: R/R lsb: N/A  
 XMIT RATE Aperiodic  
 SIGNAL TYPE Discrete  
 UNITS N/A

BIT NO.	DESCRIPTION
0 msb	-----
1	Hex Digit #1 = 0
2	
3 lsb	-----
4 msb	-----
5	Hex Digit #2 = 0
6	
7 lsb	-----
8 msb	-----
9	Hex Digit #3 = 0
10	
11 lsb	-----
12 msb	-----
13	Hex Digit #4 = C
14	
15 lsb	-----

A.1.j. Replay Command

The Replay command is used to start, pause, continue, and control the speed of replay of the recorded data.

MESSAGE NAME: Replay

MESSAGE ID: R1-009 TRANSFER TYPE: BC-RT

SOURCE: BC WORD COUNT: 32

DESTINATION: R/R

WORD NAME	WORD NO.	DESCRIPTION
Command Word	CW	Subaddress 00001 binary
Replay Command ID	01	ID of Replay command = 0x0009
Replay Type/Speed	02	Start/continue and speed control
Replay Time Word 1	03	Start time seconds/milliseconds
Replay Time Word 2	04	Start time hours/minutes
Replay Time Word 3	05	Start time month/days
Replay Time Word 4	06	Start time year
Zero	07-32	Zero-filled
Status Word	SW	MIL-STD-1553 Status Word

WORD NAME: Replay Command ID

WORD ID: R1-009-01 RANGE: N/A  
 SOURCE: BC ACCURACY: N/A  
 DESTINATION: R/R lsb: N/A  
 XMIT RATE Aperiodic  
 SIGNAL TYPE Discrete  
 UNITS N/A

BIT NO.	DESCRIPTION
0 msb	-----
1	Hex Digit #1 = 0
2	
3 lsb	-----
4 msb	-----
5	Hex Digit #2 = 0
6	
7 lsb	-----
8 msb	-----
9	Hex Digit #3 = 0
10	
11 lsb	-----
12 msb	-----
13	Hex Digit #4 = 9
14	
15 lsb	-----

WORD NAME:      Replay Type/Speed

WORD ID:	R1-009-02	RANGE:	N/A
SOURCE:	BC	ACCURACY:	N/A
DESTINATION:	R/R	lsb:	N/A
XMIT RATE	Aperiodic		
SIGNAL TYPE	Discrete		
UNITS	N/A		

BIT NO.                                   DESCRIPTION

0      msb    Bits 0-3: A series of binary values representing the type of replay.  
Bit No.      0123

0000 = Begin Replay @ Time and Speed<sup>1</sup>  
0001 = Play Live (ignore bits 4-7)  
0010 = Continue Replay @ Speed<sup>2</sup>  
0011 - 1111 = Reserved

  Bits 4-7: A series of binary values indicating replay speed.  
Bit No.      4567

0000 = Pause (Speed Zero)  
0001 = Normal Speed (real-time)  
0010 - 1111 per R/R Specification

15      lsb                              Bit 8 - 15 Binary 0

Note 1:    Begin Replay @ Time and Speed command option is only valid when replay is currently stopped (see STOP receive command). The Replay message time words (data words 3-6) are used to locate the desired replay point. If the time specified in these replay time words is not found in the recorded data, the R/R will set the Last Receive Command Error bit in the Status transmit message.

Note 2:    Continue Replay @ Speed command option is used following a Queue command to initiate replay at the queued replay point. It is also used to change replay speeds or pause and resume replay at the current replay point. The Replay message time words are unused and zero-filled.

WORD NAME                              Replay Time Word 1

WORD ID:	R1-009-03	RANGE:	N/A
SOURCE:	BC	ACCURACY:	N/A
DESTINATION:	R/R	lsb:	N/A
XMIT RATE	Aperiodic		
SIGNAL TYPE	Discrete		
UNITS	N/A		

BIT NO.		DESCRIPTION
0	msb	-----
1		Hex Digit #1 = Tens of seconds, binary 0 to 5
2		
3	lsb	-----
4	msb	-----
5		Hex Digit #2 = Units of seconds, binary 0 to 9
6		
7	lsb	-----
8	msb	-----
9		Hex Digit #3 = Hundreds of milliseconds, binary 0 to 9
10		
11	lsb	-----
12	msb	-----
13		Hex Digit #4 = Tens of milliseconds, binary 0 to 9
14		
15	lsb	-----

WORD NAME                      Replay Time Word 2

WORD ID:	R1-009-04	RANGE:	N/A
SOURCE:	BC	ACCURACY:	N/A
DESTINATION:	R/R	lsb:	N/A
XMIT RATE	Aperiodic		
SIGNAL TYPE	Discrete		
UNITS	N/A		

BIT NO.		DESCRIPTION
0	msb	-----
1		Hex Digit #1 = Tens of hours, binary 0 to 2 <sup>1</sup>
2		
3	lsb	-----
4	msb	-----
5		Hex Digit #2 = Units of hours, binary 0 to 9 <sup>1</sup>
6		
7	lsb	-----
8	msb	-----
9		Hex Digit #3 = Tens of minutes, binary 0 to 5
10		
11	lsb	-----
12	msb	-----
13		Hex Digit #4 = Units of minutes, binary 0 to 9
14		

15    lsb                    -----

Note 1.    Hex digit #1 and hex digit #2 (tens of hours and units of hours) must together be a decimal number from 00 to 23

WORD NAME            Replay Time Word 3

WORD ID:	R1-009-05	RANGE:	N/A
SOURCE:	BC	ACCURACY:	N/A
DESTINATION:	R/R	lsb:	N/A
XMIT RATE	Aperiodic		
SIGNAL TYPE	Discrete		
UNITS	N/A		

BIT NO.                                    DESCRIPTION

0	msb	-----
1		Hex Digit #1 = Tens of months, binary 0 to 1 <sup>1</sup>
2		
3	lsb	-----
4	msb	-----
5		Hex Digit #2 = Units of months, binary 0 to 9 <sup>1</sup>
6		
7	lsb	-----
8	msb	-----
9		Hex Digit #3 = Tens of days, binary 0 to 3 <sup>2,3</sup>
10		
11	lsb	-----
12	msb	-----
13		Hex Digit #4 = Units of days, binary 0 to 9 <sup>2,3</sup>
14		
15	lsb	-----

Note 1.    Hex digit #1 and hex digit #2 (tens of months and units of months) must together be a decimal number from 01 to 12

Note 2.    Hex digit #3 and hex digit #4 (tens of days and units of days) must together be a decimal number from 01 to 31

Note 3.    Hex digit #3 and hex digit #4 (tens of days and units of days) must together be a valid number of days in the month identified by hex digit #1 and hex digit #2. For example, month 06 may only have a maximum of 30 days.

WORD NAME            Replay Time Word 4

WORD ID:	R1-009-06	RANGE:	N/A
----------	-----------	--------	-----

SOURCE: BC ACCURACY: N/A  
 DESTINATION: R/R lsb: N/A  
 XMIT RATE Aperiodic  
 SIGNAL TYPE Discrete  
 UNITS N/A

BIT NO.	DESCRIPTION
0 msb	-----
1	Hex Digit #1 = Thousands of years, binary 0 to 2
2	
3 lsb	-----
4 msb	-----
5	Hex Digit #2 = Hundreds of years, binary 0 to 9
6	
7 lsb	-----
8 msb	-----
9	Hex Digit #3 = Tens of years, binary 0 to 9
10	
11 lsb	-----
12 msb	-----
13	Hex Digit #4 = Units of years, binary 0 to 9
14	
15 lsb	-----

A.1.k. Reset Command

The Reset command is used to start a reset of the R/R. Upon receipt of a valid Reset command, the R/R negates the ready discrete output and all subsequent RT messages addressed to the R/R will be ignored until the ready discrete output is reasserted.

MESSAGE NAME: Reset

MESSAGE ID: R1-013 TRANSFER TYPE: BC-RT  
 SOURCE: BC WORD COUNT: 32  
 DESTINATION: R/R

WORD NAME	WORD NO.	DESCRIPTION
Command Word	CW	Subaddress 00001 binary
Reset Command ID	01	ID of Reset command = 0x000D
Zero	02-32	Zero-filled
Status Word	SW	MIL-STD-1553 Status Word

WORD NAME: Reset Command ID

WORD ID: R1-013-01 RANGE: N/A

SOURCE: BC ACCURACY: N/A  
 DESTINATION: R/R lsb: N/A  
 XMIT RATE Aperiodic  
 SIGNAL TYPE Discrete  
 UNITS N/A

BIT NO.	DESCRIPTION
0	msb -----
1	Hex Digit #1 = 0
2	
3	lsb -----
4	msb -----
5	Hex Digit #2 = 0
6	
7	lsb -----
8	msb -----
9	Hex Digit #3 = 0
10	
11	lsb -----
12	msb -----
13	Hex Digit #4 = D
14	
15	lsb -----

A.1.1. Resume Command

The Resume command is used to instruct the R/R to resume recording of one or more channels, either by channel type or specific channel IDs.

MESSAGE NAME: Resume

MESSAGE ID: R1-014 TRANSFER TYPE: BC-RT  
 SOURCE: BC WORD COUNT: 32  
 DESTINATION: R/R

WORD NAME	WORD NO.	DESCRIPTION
Command Word	CW	Subaddress 00001 binary
Resume Command ID	01	ID of Resume command = 0x000E
Resume Condition	02	Channel group or individual channels
Resume Channel ID	03-16	Individual Channel ID or zero
Zero	17-32	Zero-filled
Status Word	SW	MIL-STD-1553 Status Word

WORD NAME: Resume Command ID

WORD ID:	R1-014-01	RANGE:	N/A
SOURCE:	BC	ACCURACY:	N/A
DESTINATION:	R/R	lsb:	N/A
XMIT RATE	Aperiodic		
SIGNAL TYPE	Discrete		
UNITS	N/A		

BIT NO.	DESCRIPTION
0	msb -----
1	Hex Digit #1 = 0
2	
3	lsb -----
4	msb -----
5	Hex Digit #2 = 0
6	
7	lsb -----
8	msb -----
9	Hex Digit #3 = 0
10	
11	lsb -----
12	msb -----
13	Hex Digit #4 = E
14	
15	lsb -----

WORD NAME: Resume Condition

WORD ID:	R1-014-02	RANGE:	N/A
SOURCE:	BC	ACCURACY:	N/A
DESTINATION:	R/R	lsb:	N/A
XMIT RATE	Aperiodic		
SIGNAL TYPE	Discrete		
UNITS	N/A		

BIT NO. DESCRIPTION

0	msb	Binary 0
		Bits 1-3 are three-bit codes that specify the type of resume
	Bit No.	123
		000 = Individual Channel(s)
		001 = All Channels
		Remaining bits reserved



4		Binary 0
5		Binary 0
7		Binary 0
8		Binary 0
9		Binary 0
10		Binary 0
11		Binary 0
12		Binary 0
13		Binary 0
14		Binary 0
15	lsb	Binary 0

WORD NAME: Resume Channel ID

WORD ID:	R1-014-03 to R1-014-16	RANGE:	N/A
SOURCE:	BC	ACCURACY:	N/A
DESTINATION:	R/R	lsb:	N/A
XMIT RATE	Aperiodic		
SIGNAL TYPE	Discrete		
UNITS	N/A		

BIT NO. DESCRIPTION

0	msb	Bit 0 - 15 is the unsigned integer Channel ID number of a channel to be resumed when Bits 1-3 of data word 2 equal 110, otherwise these data words 3 to 16 are unused and zero-filled.
1		
2		
3		
4		
5		
6		
7		
8		
9		
10		
11		
12		
13		
14		
15	lsb	

A.1.m. Sanitize Command

The Sanitize command performs a Chapter 10 sanitization procedure on internal memory or RMM installed in the R/R. While in the Sanitize state, the percent complete is output via the STATUS transmit command. When the Sanitize procedure completes, the state of the R/R as

returned by the STATUS transmit command indicates either “pass” (state = SANITIZE PASS) or “fail” (state = SANITIZE FAIL).

MESSAGE NAME: Sanitize

MESSAGE ID: R1-003 TRANSFER TYPE: BC-RT  
 SOURCE: BC WORD COUNT: 32  
 DESTINATION: R/R

WORD NAME	WORD NO.	DESCRIPTION
Command Word	CW	Subaddress 00001 binary
Sanitize Command ID	01	ID of Sanitize command = 0x0003
Zero	2-32	Zero-filled
Status Word	SW	MIL-STD-1553 Status Word

WORD NAME: Sanitize Command ID

WORD ID: R1-003-01 RANGE: N/A  
 SOURCE: BC ACCURACY: N/A  
 DESTINATION: R/R lsb: N/A  
 XMIT RATE Aperiodic  
 SIGNAL TYPE Discrete  
 UNITS N/A

BIT NO.	DESCRIPTION
0 msb	-----
1	Hex Digit #1 = 0
2	-----
3 lsb	-----
4 msb	-----
5	Hex Digit #2 = 0
6	-----
7 lsb	-----
8 msb	-----
9	Hex Digit #3 = 0
10	-----
11 lsb	-----
12 msb	-----
13	Hex Digit #4 = 3
14	-----
15 lsb	-----

A.1.n. Stop Command

The Stop command is used to stop recording, replay, or both.

MESSAGE NAME: Stop

MESSAGE ID: R1-016 TRANSFER TYPE: BC-RT  
 SOURCE: BC WORD COUNT: 32  
 DESTINATION: R/R

WORD NAME	WORD NO.	DESCRIPTION
Command Word	CW	Subaddress 00001 binary
Stop Command ID	01	ID of Stop command = 0x0010
Stop Mode	02	One of three possible stop modes
Zero	03-32	Zero-filled
Status Word	SW	MIL-STD-1553 Status Word

WORD NAME: Stop Command ID

WORD ID: R1-016-01 RANGE: N/A  
 SOURCE: BC ACCURACY: N/A  
 DESTINATION: R/R lsb: N/A  
 XMIT RATE Aperiodic  
 SIGNAL TYPE Discrete  
 UNITS N/A

BIT NO.	DESCRIPTION
0 msb	-----
1	Hex Digit #1 = 0
2	
3 lsb	-----
4 msb	-----
5	Hex Digit #2 = 0
6	
7 lsb	-----
8 msb	-----
9	Hex Digit #3 = 1
10	
11 lsb	-----
12 msb	-----
13	Hex Digit #4 = 0
14	
15 lsb	-----

WORD NAME            Stop Mode

WORD ID:            R1-016-02            RANGE:            N/A

SOURCE:            BC                    ACCURACY:        N/A

DESTINATION:      R/R                    lsb:                N/A

XMIT RATE            Aperiodic

SIGNAL TYPE        Discrete

UNITS                N/A

BIT NO.	DESCRIPTION
0      msb	Two-bit binary code with bit 1
1	Two-bit binary code with bit 0

Bit-0	Bit-1	Description
0	0	Stop Recording and Close File
0	1	Stop Replay <sup>1</sup>
1	0	Stop Recording, Close File, and Stop Replay <sup>1</sup>
1	1	Invalid Command (reserved)

2	Binary 0
3	Binary 0
4	Binary 0
5	Binary 0
6	Binary 0
7	Binary 0
8	Binary 0
9	Binary 0
10	Binary 0
11	Binary 0
12	Binary 0
13	Binary 0
14	Binary 0
15    lsb	Binary 0

A.1.o. Time Command

The Time command is used in conjunction with the SYNC command to set the internal Time Channel time in the R/R when the Time Channel health status “synchronization failure” bit equals “1”.

MESSAGE NAME:    Time

MESSAGE ID:    R1-017    TRANSFER TYPE:    BC-RT

SOURCE:        BC WORD COUNT:    32

DESTINATION:    R/R

WORD NAME	WORD NO.	DESCRIPTION
Command Word	CW	Subaddress 00001 binary
Time Command ID	01	ID of Time command = 0x0011
Set Time Valid	02	Indicates when words 4-7 have valid time
Time of Validity	03	Indicates sync time when time was valid
Set Time Word 1	04	Seconds and Milliseconds word
Set Time Word 2	05	Hours and Minutes word
Set Time Word 3	06	Month and Day word
Set Time Word 4	07	Year word
Zero	8-32	Zero-filled
Status Word	SW	MIL-STD-1553 Status Word

WORD NAME: Time Command ID

WORD ID:	R1-017-01	RANGE:	N/A
SOURCE:	BC	ACCURACY:	N/A
DESTINATION:	R/R	lsb:	N/A
XMIT RATE	Aperiodic		
SIGNAL TYPE	Discrete		
UNITS	N/A		

BIT NO.	DESCRIPTION
0	msb -----
1	Hex Digit #1 = 0
2	
3	lsb -----
4	msb -----
5	Hex Digit #2 = 0
6	
7	lsb -----
8	msb -----
9	Hex Digit #3 = 1
10	
11	lsb -----
12	msb -----
13	Hex Digit #4 = 1
14	
15	lsb -----

WORD NAME Set Time Valid

WORD ID:	R1-017-02	RANGE:	N/A
SOURCE:	BC	ACCURACY:	N/A

DESTINATION:	R/R	lsb:	N/A
XMIT RATE	Aperiodic		
SIGNAL TYPE	Discrete		
UNITS	N/A		

BIT NO. DESCRIPTION

0	msb	Time Valid bit: 1 = time words valid, 0 = time words not valid
1		Binary 0
2		Binary 0
3		Binary 0
4		Binary 0
5		Binary 0
6		Binary 0
7		Binary 0
8		Binary 0
9		Binary 0
10		Binary 0
11		Binary 0
12		Binary 0
13		Binary 0
14		Binary 0
15	lsb	Binary 0

WORD NAME Time of Validity

WORD ID:	R1-017-03	RANGE:	N/A
SOURCE:	BC	ACCURACY:	N/A
DESTINATION:	R/R	lsb:	50 microseconds
XMIT RATE	Aperiodic		
SIGNAL TYPE	Discrete		
UNITS	N/A		

BIT NO. DESCRIPTION

0	msb	
1		
2		
3		Bits 0-15: An unsigned binary integer representing the time at which the Set Time is valid, based on the BC clock synchronization time. The lsb is 50 microseconds.
4		
5		
6		
7		
8		
9		

10  
 11  
 12  
 13  
 14  
 15     lsb

WORD NAME           Set Time Word 1

WORD ID:            R1-017-04            RANGE:            N/A  
 SOURCE:            BC                    ACCURACY:         N/A  
 DESTINATION:      R/R                   lsb:               N/A  
 XMIT RATE         Aperiodic  
 SIGNAL TYPE        Discrete  
 UNITS              N/A

BIT NO.		DESCRIPTION
0	msb	-----
1		Hex Digit #1 = Tens of seconds, binary 0 to 5
2		
3	lsb	-----
4	msb	-----
5		Hex Digit #2 = Units of seconds, binary 0 to 9
6		
7	lsb	-----
8	msb	-----
9		Hex Digit #3 = Hundreds of milliseconds, binary 0 to 9
10		
11	lsb	-----
12	msb	-----
13		Hex Digit #4 = Tens of milliseconds, binary 0 to 9
14		
15	lsb	-----

WORD NAME           Set Time Word 2

WORD ID:            R1-017-05            RANGE:            N/A  
 SOURCE:            BC                    ACCURACY:         N/A  
 DESTINATION:      R/R                   lsb:               N/A  
 XMIT RATE         Aperiodic  
 SIGNAL TYPE        Discrete  
 UNITS              N/A

BIT NO.		DESCRIPTION
0	msb	-----
1		Hex Digit #1 = Tens of hours, binary 0 to 2 <sup>1</sup>
2		
3	lsb	-----
4	msb	-----
5		Hex Digit #2 = Units of hours, binary 0 to 9 <sup>1</sup>
6		
7	lsb	-----
8	msb	-----
9		Hex Digit #3 = Tens of minutes, binary 0 to 5
10		
11	lsb	-----
12	msb	-----
13		Hex Digit #4 = Units of minutes, binary 0 to 9
14		
15	lsb	-----

Note 1. Hex digit #1 and hex digit #2 (tens of hours and units of hours) must together be a decimal number from 00 to 23

WORD NAME	Set Time Word 3		
WORD ID:	R1-017-06	RANGE:	N/A
SOURCE:	BC	ACCURACY:	N/A
DESTINATION:	R/R	lsb:	N/A
XMIT RATE	Aperiodic		
SIGNAL TYPE	Discrete		
UNITS	N/A		

BIT NO.		DESCRIPTION
0	msb	-----
1		Hex Digit #1 = Tens of months, binary 0 to 1 <sup>1</sup>
2		
3	lsb	-----
4	msb	-----
5		Hex Digit #2 = Units of months, binary 0 to 9 <sup>1</sup>
6		
7	lsb	-----
8	msb	-----
9		Hex Digit #3 = Tens of days, binary 0 to 3 <sup>2,3</sup>
10		
11	lsb	-----
12	msb	-----



13                                      Hex Digit #4 = Units of days, binary 0 to 9<sup>2,3</sup>  
 14  
 15    lsb                                      -----

- Note 1.    Hex digit #1 and hex digit #2 (tens of months and units of months) must together be a decimal number from 01 to 12
- Note 2.    Hex digit #3 and hex digit #4 (tens of days and units of days) must together be a decimal number from 01 to 31
- Note 3.    Hex digit #3 and hex digit #4 (tens of days and units of days) must together be a valid number of days in the month identified by hex digit #1 and hex digit #2. For example, month 06 may only have a maximum of 30 days.

WORD NAME                      Set Time Word 4

WORD ID:	R1-017-07	RANGE:	N/A
SOURCE:	BC	ACCURACY:	N/A
DESTINATION:	R/R	lsb:	N/A
XMIT RATE	Aperiodic		
SIGNAL TYPE	Discrete		
UNITS	N/A		

BIT NO.		DESCRIPTION
0	msb	-----
1		Hex Digit #1 = Thousands of years, binary 0 to 2
2		
3	lsb	-----
4	msb	-----
5		Hex Digit #2 = Hundreds of years, binary 0 to 9
6		
7	lsb	-----
8	msb	-----
9		Hex Digit #3 = Tens of years, binary 0 to 9
10		
11	lsb	-----
12	msb	-----
13		Hex Digit #4 = Units of years, binary 0 to 9
14		
15	lsb	-----

A.1.p. Sync Command

The Sync command is used to send the current value of the BC clock synchronization time to the R/R.

MESSAGE NAME: Sync

MESSAGE ID: R2            TRANSFER TYPE: BC-RT  
 SOURCE: BC            WORD COUNT: 1  
 DESTINATION: R/R

WORD NAME	WORD NO.	DESCRIPTION
Command Word	CW	Subaddress 00010 binary
Synchronization Time	01	BC Clock Synchronization Time
Status Word	SW	MIL-STD-1553 Status Word

WORD NAME: Synchronization Time

WORD ID: R2-01                      RANGE: N/A  
 SOURCE: BC                          ACCURACY: N/A  
 DESTINATION: R/R                      lsb: 50 microseconds  
 XMIT RATE Aperiodic  
 SIGNAL TYPE Discrete  
 UNITS N/A

BIT NO.	DESCRIPTION
0      msb	-----
1	
2	
3	
4	
5	
6	
7	
8	
9	
10	
11	
12	
13	
14	
15     lsb	-----

Note: 50 microsecond count used to synchronize the internal R/R clock to the BC clock. When a TIME command is received by the R/R, the most recent SYNC command clock synchronization word is used to calculate the correct time to load into the R/R clock based on the time of validity parameter contained in the TIME command.

**A.2. Transmit Messages**

[Table A-2](#) provides a description of the MIL-STD-1553 transmit commands defined in the following sections.

<b>Table A-2. Military Standard 1553 Transmit (Remote Terminal to Bus Controller) Command Set</b>		
<b>Command</b>	<b>Subaddress</b>	<b>Description</b>
EVENTS	2	Returns the number of occurrences of defined events
HEALTH	3	Returns detailed R/R health information
INFO	4	Returns detailed information about a specific file or event in response to a received INFO BC to RT message (see <a href="#">Table A-1</a> )
STATUS	5	Returns the current system status and statistics

**A.2.a. Transmit Message Length**

All response (transmit) messages have 32 data words. All unused data words are zero-filled. If the BC requests less than 32 words in the RT to BC command word, only a valid status word and the requested number of data words will be transmitted.

**A.2.b. Events Command**

Each time the BC sends an Event command (R1-005 above), the R/R will increment the internal “occurrence” counter for the specified event. This Event command causes the R/R to transmit the number of occurrences of events 1 to 31. Undefined event occurrence counts are 0.

MESSAGE NAME: Events

MESSAGE ID: T3                      TRANSFER TYPE: RT - BC  
SOURCE: R/R                      WORD COUNT: 32  
DESTINATION: BC

<u>WORD NAME</u>	<u>WORD NO.</u>	<u>DESCRIPTION</u>
Command Word	CW	Subaddress 00011 binary
Status Word	SW	MIL-STD-1553 Status Word
Event 1 Occurrences	01	Number of times Event 1 occurred
Event 2 Occurrences	02	Number of times Event 2 occurred
Event 3 Occurrences	03	Number of times Event 3 occurred
Event 4 Occurrences	04	Number of times Event 4 occurred
Event 5 Occurrences	05	Number of times Event 5 occurred
Event 6 Occurrences	06	Number of times Event 6 occurred
Event 7 Occurrences	07	Number of times Event 7 occurred
Event 8 Occurrences	08	Number of times Event 8 occurred
Event 9 Occurrences	09	Number of times Event 9 occurred
Event 10 Occurrences	10	Number of times Event 10 occurred
Event 11 Occurrences	11	Number of times Event 11 occurred
Event 12 Occurrences	12	Number of times Event 12 occurred

Event 13 Occurrences	13	Number of times Event 13 occurred
Event 14 Occurrences	14	Number of times Event 14 occurred
Event 15 Occurrences	15	Number of times Event 15 occurred
Event 16 Occurrences	16	Number of times Event 16 occurred
Event 17 Occurrences	17	Number of times Event 17 occurred
Event 18 Occurrences	18	Number of times Event 18 occurred
Event 19 Occurrences	19	Number of times Event 19 occurred
Event 20 Occurrences	20	Number of times Event 20 occurred
Event 21 Occurrences	21	Number of times Event 21 occurred
Event 22 Occurrences	22	Number of times Event 22 occurred
Event 23 Occurrences	23	Number of times Event 23 occurred
Event 24 Occurrences	24	Number of times Event 24 occurred
Event 25 Occurrences	25	Number of times Event 25 occurred
Event 26 Occurrences	26	Number of times Event 26 occurred
Event 27 Occurrences	27	Number of times Event 27 occurred
Event 28 Occurrences	28	Number of times Event 28 occurred
Event 29 Occurrences	29	Number of times Event 29 occurred
Event 30 Occurrences	30	Number of times Event 30 occurred
Event 31 Occurrences	31	Number of times Event 31 occurred
Zero	32	Zero-filled

WORD NAME: Event N Occurrences

WORD ID:	T3-01 to T3-31	RANGE:	0 - 65535
SOURCE:	R/R	ACCURACY:	N/A
DESTINATION:	BC	lsb:	N/A
XMIT RATE	Periodic		
SIGNAL TYPE	Discrete		
UNITS	N/A		

BIT NO.		DESCRIPTION
0	msb	Bit 0 - 15 is the unsigned integer number of times that the corresponding Event occurred or zero if the corresponding event is undefined.
1		
2		
3		
4		
5		
6		
7		
8		
9		
10		
11		
12		

13  
 14  
 15    lsb

A.2.c. Health Command

The Health command returns status bits that indicate warning or error conditions within the R/R. Any non-zero health bit is either a warning condition or an error condition. Detailed health bit descriptions are provided in [Table 6-2](#).

MESSAGE NAME:   Health

MESSAGE ID:    T4           TRANSFER TYPE:   RT - BC  
 SOURCE:        R/R         WORD COUNT:     32  
 DESTINATION:  BC

WORD NAME	WORD NO.	DESCRIPTION
Command Word	CW	Subaddress 00100 binary Subaddresses 00111 - 10000 binary are used to extend Health command channel health word count.
Status Word	SW	MIL-STD-1553 Status Word
Recorder Health	01	Recorder and RMM status bits
Channel Health	02-32	Individual channel status bits

Note:        Channel health status bits are IAW the .HEALTH command defined in Subsection [6.2.3.3](#).

Time Channel Health        02                    Time channel status bits

WORD NAME:     Recorder Health

WORD ID:        T4-01                    RANGE:            N/A  
 SOURCE:        R/R                     ACCURACY:        N/A  
 DESTINATION:  BC                       lsb:               N/A  
 XMIT RATE     Periodic  
 SIGNAL TYPE   Discrete  
 UNITS         N/A

BIT NO.	DESCRIPTION
0    msb	IAW .HEALTH use of status bits table (ch6)
1	IAW .HEALTH use of status bits table
2	IAW .HEALTH use of status bits table
3	IAW .HEALTH use of status bits table

4		IAW .HEALTH use of status bits table
5		IAW .HEALTH use of status bits table
6		IAW .HEALTH use of status bits table
7		IAW .HEALTH use of status bits table
8		IAW .HEALTH use of status bits table
9		Drive Full
10		Drive I/O Failure
11		No Drive
12		Unused (zero)
13		Operation Failure
14		Setup Failure
15	lsb	Bit Failure

WORD NAME: Time Channel Health

WORD ID:	T4-02	RANGE:	N/A
SOURCE:	R/R	ACCURACY:	N/A
DESTINATION:	BC	lsb:	N/A
XMIT RATE	Periodic		
SIGNAL TYPE	Discrete		
UNITS	N/A		

BIT NO.		DESCRIPTION
0	msb	IAW .HEALTH use of status bits table
1		IAW .HEALTH use of status bits table
2		IAW .HEALTH use of status bits table
3		IAW .HEALTH use of status bits table
4		IAW .HEALTH use of status bits table
5		IAW .HEALTH use of status bits table
6		IAW .HEALTH use of status bits table
7		IAW .HEALTH use of status bits table
8		IAW .HEALTH use of status bits table
9		IAW .HEALTH use of status bits table
10		IAW .HEALTH use of status bits table
11		Synchronization Failure
12		Bad External Signal
13		No External Signal
14		Setup Failure
15	lsb	Bit Failure

WORD NAME: Channel (n) Health

WORD ID:	T4-03 - T4-32	RANGE:	N/A
----------	---------------	--------	-----

SOURCE:	R/R	ACCURACY:	N/A
DESTINATION:	BC	lsb:	N/A
XMIT RATE	Periodic		
SIGNAL TYPE	Discrete		
UNITS	N/A		

BIT NO.		DESCRIPTION
0	msb	IAW .HEALTH use of status bits table
1		IAW .HEALTH use of status bits table
2		IAW .HEALTH use of status bits table
3		IAW .HEALTH use of status bits table
4		IAW .HEALTH use of status bits table
5		IAW .HEALTH use of status bits table
6		IAW .HEALTH use of status bits table
7		IAW .HEALTH use of status bits table
8		IAW .HEALTH use of status bits table
9		IAW .HEALTH use of status bits table
10		IAW .HEALTH use of status bits table
11		IAW .HEALTH use of status bits table
12		IAW .HEALTH use of status bits table
13		IAW .HEALTH use of status bits table
14		IAW .HEALTH use of status bits table
15	lsb	Bit Failure

A.2.d. Info (transmit) Command

The Info transmit command retrieves internal memory or RMM data file start and end time or an event occurrence time as requested by the most recent Info receive (R1-007) command. Validity bits in data words 1 and 10 indicate when the specific file or event information is valid.

MESSAGE NAME: Info (transmit)

MESSAGE ID:	T5	TRANSFER TYPE:	RT - BC
SOURCE:	R/R	WORD COUNT:	32
DESTINATION:	BC		

<u>WORD NAME</u>	<u>WORD NO.</u>	<u>DESCRIPTION</u>
Command Word	CW	Subaddress 00101 binary
Status Word	SW	MIL-STD-1553 Status Word
File Number	01	Info requested for this file
File Start Time Word 1	02	File start time seconds & milliseconds
File Start Time Word 2	03	File start time hours & minutes
File Start Time Word 3	04	File start time month & days

File Start Time Word 4	05	File start time year
File End Time Word 1	06	File end time seconds & milliseconds
File End Time Word 2	07	File end time hours & minutes
File End Time Word 3	08	File end time month & days
File End Time Word 4	09	File end time year
Event Number	10	Info requested for this event
Event Occurrence	11	Info requested for this occurrence
Event Time Word 1	12	Event time seconds & milliseconds
Event Time Word 2	13	Event time hours & minutes
Event Time Word 3	14	Event time month & days
Event Time Word 4	15	Event time year
Zero	16-32	Zero-filled

WORD NAME: File Number

WORD ID:	T5-01	RANGE:	see below
SOURCE:	R/R	ACCURACY:	N/A
DESTINATION:	BC	lsb:	N/A
XMIT RATE	Periodic		
SIGNAL TYPE	Discrete		
UNITS	N/A		

BIT NO.		DESCRIPTION
0	msb	Bit 0: File Info Validity; Valid = 1, Invalid = 0
1		Bit 1 - 15 is the unsigned integer file number of the requested file from
2		1 to the number of files in Status message data word 5 (T6-005)
3		
4		
5		
6		
7		
8		
9		
10		
11		
12		
13		
14		
15	lsb	

Note: File Info Validity applies to the file number in this data word and the start and end times in the next eight data words.

WORD NAME File Start, File End, or Event Time Word 1



WORD ID:	T5-02, T5-06, or T5-12	RANGE:	N/A
SOURCE:	R/R	ACCURACY:	N/A
DESTINATION:	BC	lsb:	N/A
XMIT RATE	Periodic		
SIGNAL TYPE	Discrete		
UNITS	N/A		

BIT NO.	DESCRIPTION
0	msb
1	-----
2	Hex Digit #1 = Tens of seconds, binary 0 to 5
3	lsb
4	-----
5	msb
6	Hex Digit #2 = Units of seconds, binary 0 to 9
7	lsb
8	-----
9	msb
10	Hex Digit #3 = Hundreds of milliseconds, binary 0 to 9
11	lsb
12	-----
13	msb
14	Hex Digit #4 = Tens of milliseconds, binary 0 to 9
15	lsb
	-----

WORD NAME            File Start, File End, or Event Time Word 2

WORD ID:	T5-03, T5-07, or T5-13	RANGE:	N/A
SOURCE:	R/R	ACCURACY:	N/A
DESTINATION:	BC	lsb:	N/A
XMIT RATE	Periodic		
SIGNAL TYPE	Discrete		
UNITS	N/A		

BIT NO.	DESCRIPTION
0	msb
1	-----
2	Hex Digit #1 = Tens of hours, binary 0 to 2 <sup>1</sup>
3	lsb
4	-----
5	msb
6	Hex Digit #2 = Units of hours, binary 0 to 9 <sup>1</sup>
7	lsb
	-----

8	msb	-----
9		Hex Digit #3 = Tens of minutes, binary 0 to 5
10		
11	lsb	-----
12	msb	-----
13		Hex Digit #4 = Units of minutes, binary 0 to 9
14		
15	lsb	-----

Note 1. Hex digit #1 and hex digit #2 (tens of hours and units of hours) must together be a decimal number from 00 to 23.

WORD NAME	File Start, File End, or Event Time Word 3		
WORD ID:	T5-04, T5-08, or T5-14	RANGE:	N/A
SOURCE:	R/R	ACCURACY:	N/A
DESTINATION:	BC	lsb:	N/A
XMIT RATE	Periodic		
SIGNAL TYPE	Discrete		
UNITS	N/A		

BIT NO.		DESCRIPTION
0	msb	-----
1		Hex Digit #1 = Tens of months, binary 0 to 1 <sup>1</sup>
2		
3	lsb	-----
4	msb	-----
5		Hex Digit #2 = Units of months, binary 0 to 9 <sup>1</sup>
6		
7	lsb	-----
8	msb	-----
9		Hex Digit #3 = Tens of days, binary 0 to 3 <sup>2,3</sup>
10		
11	lsb	-----
12	msb	-----
13		Hex Digit #4 = Units of days, binary 0 to 9 <sup>2,3</sup>
14		
15	lsb	-----

Note 1. Hex digit #1 and hex digit #2 (tens of months and units of months) must together be a decimal number from 01 to 12.

Note 2. Hex digit #3 and hex digit #4 (tens of days and units of days) must together be a decimal number from 01 to 31.

Note 3. Hex digit #3 and hex digit #4 (tens of days and units of days) must together be a valid number of days in the month identified by hex digit #1 and hex digit #2. For example, month 06 may only have a maximum of 30 days.

WORD NAME	File Start, File End, or Event Time Word 4		
WORD ID:	T5-05, T5-09, or T5-15	RANGE:	N/A
SOURCE:	R/R	ACCURACY:	N/A
DESTINATION:	BC	lsb:	N/A
XMIT RATE	Periodic		
SIGNAL TYPE	Discrete		
UNITS	N/A		

BIT NO.		DESCRIPTION
0	msb	-----
1		Hex Digit #1 = Thousands of years, binary 0 to 2
2		
3	lsb	-----
4	msb	-----
5		Hex Digit #2 = Hundreds of years, binary 0 to 9
6		
7	lsb	-----
8	msb	-----
9		Hex Digit #3 = Tens of years, binary 0 to 9
10		
11	lsb	-----
12	msb	-----
13		Hex Digit #4 = Units of years, binary 0 to 9
14		
15	lsb	-----

WORD NAME:	Event Number		
WORD ID:	T5-10	RANGE:	see below
SOURCE:	R/R	ACCURACY:	N/A
DESTINATION:	BC	lsb:	N/A
XMIT RATE	Periodic		
SIGNAL TYPE	Discrete		
UNITS	N/A		

BIT NO.		DESCRIPTION
0	msb	Bit 0: Event Info Validity; Valid = 1, Invalid = 0
1		Bit 1 - 15 is the unsigned integer event number of the requested event

2		from 1 to the number of defined events in Status message data word 14
3		(T6-014)
4		
5		
6		
7		
8		
9		
10		
11		
12		
13		
14		
15	lsb	

Note: Event Info Validity applies to the event number in this data word, the event occurrence number in data word 11, and the event time in data words 12, 13, 14, and 15.

WORD NAME: Event Occurrence

WORD ID:	T5-11	RANGE:	1 - 65535
SOURCE:	R/R	ACCURACY:	N/A
DESTINATION:	BC	lsb:	N/A
XMIT RATE	Periodic		
SIGNAL TYPE	Discrete		
UNITS	N/A		

BIT NO.		DESCRIPTION
0	msb	Bit 0 - 15 is the unsigned integer event occurrence number of the requested BC event
1		
2		
3		
4		
5		
6		
7		
8		
9		
10		
11		
12		
13		
14		
15	lsb	

A.2.e. Status Command

The Status command retrieves R/R status and configuration information. A validity bit in data word 1 indicates when the status and configuration information is valid.

MESSAGE NAME: Status

MESSAGE ID: T6            TRANSFER TYPE: RT - BC  
 SOURCE: R/R            WORD COUNT: 32  
 DESTINATION: BC

WORD NAME	WORD NO.	DESCRIPTION
Command Word	CW	Subaddress 00110 binary
Status Word	SW	MIL-STD-1553 Status Word
State/Speed/Video/Error	01	Multiple system status fields
Command Percent Complete	02	Record/BIT/Erase/Sanitize % complete
Internal Memory/RMM Size	03	Internal Memory/RMM capacity in gigabytes
Memory Percent Available	04	Amount (%) of unused memory
Number of Files	05	Number of used file table entries
System Time Word 1	06	System time seconds & milliseconds
System Time Word 2	07	System time hours & minutes
System Time Word 3	08	System time month & days
System Time Word 4	09	System time year
Replay Time Word 1	10	Current replay time seconds & milliseconds
Replay Time Word 2	11	Current replay hours & minutes
Replay Time Word 3	12	Current replay month & days
Replay Time Word 4	13	Current replay year
Number of Defined Events	14	Number of BC events in TMATS file
Firmware Version	15	Firmware version numbers
TMATS File Revision	16	TMATS Setup File revision number
Zero	17-32	Zero-filled

WORD NAME            State/Speed /Error

WORD ID:            T6-01            RANGE:            N/A  
 SOURCE:            R/R            ACCURACY:        N/A  
 DESTINATION:      BC            lsb:            N/A  
 XMIT RATE        Periodic  
 SIGNAL TYPE      Discrete  
 UNITS            N/A

BIT NO.	DESCRIPTION
0      msb	Bit 0 - 3 = one of the following state codes

Bit	0123	
		0000 = FAIL
		0001 = IDLE
		0010 = BIT
		0011 = ERASE
		0100 = SANITIZE
		0101 = RECORD
		0110 = PLAY
		0111 = RECORD & PLAY
		1000 = QUEUE (FIND)
		1001 = BUSY
		1010 = COMMAND ERROR
		1011 = SANITIZE ERROR
		1100 = SANITIZE PASS
		1101-1111 = Reserved
		Bit 4 - 7 = binary value representing current replay speed
Bit	4567	
		0000 = Pause (Speed Zero)
		0001 = Normal Speed (Real-Time)
		0010 - 1111 = User Defined
		Bits 8-10: Reserved
		Bit 11: Last Receive Command Error
		0 = Last BC to RT command was valid and accepted
		1 = Last BC to RT command was illegal/invalid and rejected
		Bit 12: Status message validity
		0 = All message words are invalid
		1 = All message words are valid
		Bits 13-14: Queue command status
Bit	13 14	
	0 0	= No queue command status
	0 1	= Queue command passed
	1 0	= Queue command failed
	1 1	= Queue command in progress
15	lsb	Play Live Mode status <sup>1</sup>
		0 = Not in Play Live mode
		1 = In Play Live mode

Note 1. Play Live Mode status is cleared by the Stop Replay command.

WORD NAME: Command Percent Complete

WORD ID:	T6-02	RANGE:	0 - 100
SOURCE:	R/R	ACCURACY:	N/A
DESTINATION:	BC	lsb:	N/A
XMIT RATE	Periodic		
SIGNAL TYPE	Discrete		
UNITS	N/A		

BIT NO.		DESCRIPTION
0	msb	Bit 0 - 15 is the unsigned integer percent complete for the Record, Record & Play, BIT, Erase, or Sanitize command when the R/R is in the corresponding state as specified by data word 1 (T6-01) bits 0-3. In the Record & Play state, the percent complete applies to the recording.
1		
2		
3		
4		
5		
6		
7		
8		
9		
10		
11		
12		
13		
14		
15	lsb	

WORD NAME: Internal Memory/RMM Size

WORD ID:	T6-03	RANGE:	N/A
SOURCE:	R/R	ACCURACY:	N/A
DESTINATION:	BC	lsb:	N/A
XMIT RATE	Periodic		
SIGNAL TYPE	Discrete		
UNITS	N/A		

BIT NO.		DESCRIPTION
0	msb	Bit 0 - 15 is the unsigned integer capacity of the Internal Memory/RMM in Gigabytes (example: 64 = 64,000,000,000 bytes)
1		
2		
3		
4		
5		

6  
 7  
 8  
 9  
 10  
 11  
 12  
 13  
 14  
 15    lsb

WORD NAME:     Memory Percent Available

WORD ID:	T6-04	RANGE:	0 - 100
SOURCE:	R/R	ACCURACY:	N/A
DESTINATION:	BC	lsb:	N/A
XMIT RATE	Periodic		
SIGNAL TYPE	Discrete		
UNITS	N/A		

BIT NO.	DESCRIPTION
0     msb	Bit 0 - 15 is the unsigned integer percent of unused (available) storage capacity from 0 to 100 (0 = full, 100 = empty)
1	
2	
3	
4	
5	
6	
7	
8	
9	
10	
11	
12	
13	
14	
15    lsb	

WORD NAME:     Number of Files

WORD ID:	T6-05	RANGE:	0 - 512
SOURCE:	R/R	ACCURACY:	N/A
DESTINATION:	BC	lsb:	N/A



XMIT RATE            Periodic  
 SIGNAL TYPE        Discrete  
 UNITS                N/A

BIT NO.		DESCRIPTION
0	msb	Bit 0 - 15 is the unsigned integer number of files or zero if no RMM is mounted in the R/R
1		
2		
3		
4		
5		
6		
7		
8		
9		
10		
11		
12		
13		
14		
15	lsb	

WORD NAME            System or Replay Time Word 1

WORD ID:              T6-06 or T6-10                      RANGE:                      N/A  
 SOURCE:                R/R                                      ACCURACY:                N/A  
 DESTINATION:        BC                                        lsb:                        N/A  
 XMIT RATE            Periodic  
 SIGNAL TYPE        Discrete  
 UNITS                N/A

BIT NO.		DESCRIPTION
0	msb	-----
1		Hex Digit #1 = Tens of seconds, binary 0 to 5
2		
3	lsb	-----
4	msb	-----
5		Hex Digit #2 = Units of seconds, binary 0 to 9
6		
7	lsb	-----
8	msb	-----
9		Hex Digit #3 = Hundreds of milliseconds, binary 0 to 9
10		

11	lsb	-----
12	msb	-----
13		Hex Digit #4 = Tens of milliseconds, binary 0 to 9
14		
15	lsb	-----

WORD NAME            System or Replay Time Word 2

WORD ID:	T6-07 or T6-11	RANGE:	N/A
SOURCE:	R/R	ACCURACY:	N/A
DESTINATION:	BC	lsb:	N/A
XMIT RATE	Periodic		
SIGNAL TYPE	Discrete		
UNITS	N/A		

BIT NO.		DESCRIPTION
0	msb	-----
1		Hex Digit #1 = Tens of hours, binary 0 to 2 <sup>1</sup>
2		
3	lsb	-----
4	msb	-----
5		Hex Digit #2 = Units of hours, binary 0 to 9 <sup>1</sup>
6		
7	lsb	-----
8	msb	-----
9		Hex Digit #3 = Tens of minutes, binary 0 to 5
10		
11	lsb	-----
12	msb	-----
13		Hex Digit #4 = Units of minutes, binary 0 to 9
14		
15	lsb	-----

Note 1.    Hex digit #1 and hex digit #2 (tens of hours and units of hours) must together be a decimal number from 00 to 23

WORD NAME            System or Replay Time Word 3

WORD ID:	T6-08 or T6-12	RANGE:	N/A
SOURCE:	R/R	ACCURACY:	N/A
DESTINATION:	BC	lsb:	N/A
XMIT RATE	Periodic		
SIGNAL TYPE	Discrete		
UNITS	N/A		

BIT NO.		DESCRIPTION
0	msb	-----
1		Hex Digit #1 = Tens of months, binary 0 to 1 <sup>1</sup>
2		
3	lsb	-----
4	msb	-----
5		Hex Digit #2 = Units of months, binary 0 to 9 <sup>1</sup>
6		
7	lsb	-----
8	msb	-----
9		Hex Digit #3 = Tens of days, binary 0 to 3 <sup>2,3</sup>
10		
11	lsb	-----
12	msb	-----
13		Hex Digit #4 = Units of days, binary 0 to 9 <sup>2,3</sup>
14		
15	lsb	-----

- Note 1. Hex digit #1 and hex digit #2 (tens of months and units of months) must together be a decimal number from 01 to 12
- Note 2. Hex digit #3 and hex digit #4 (tens of days and units of days) must together be a decimal number from 01 to 31
- Note 3. Hex digit #3 and hex digit #4 (tens of days and units of days) must together be a valid number of days in the month identified by hex digit #1 and hex digit #2. For example, month 06 may only have a maximum of 30 days.

WORD NAME	System or Replay Time Word 4		
WORD ID:	T6-09 or T6-13	RANGE:	N/A
SOURCE:	R/R	ACCURACY:	N/A
DESTINATION:	BC	lsb:	N/A
XMIT RATE	Periodic		
SIGNAL TYPE	Discrete		
UNITS	N/A		

BIT NO.		DESCRIPTION
0	msb	-----
1		Hex Digit #1 = Thousands of years, binary 0 to 2
2		
3	lsb	-----
4	msb	-----
5		Hex Digit #2 = Hundreds of years, binary 0 to 9

6		
7	lsb	-----
8	msb	-----
9		Hex Digit #3 = Tens of years, binary 0 to 9
10		
11	lsb	-----
12	msb	-----
13		Hex Digit #4 = Units of years, binary 0 to 9
14		
15	lsb	-----

WORD NAME: Number of BC Events

WORD ID:	T6-14	RANGE:	0 - 31
SOURCE:	R/R	ACCURACY:	N/A
DESTINATION:	BC	lsb:	N/A
XMIT RATE	Periodic		
SIGNAL TYPE	Discrete		
UNITS	N/A		

BIT NO.		DESCRIPTION
0	msb	Bit 0 - 15 is the unsigned integer number of defined BC events from 0 to 31
1		
2		
3		
4		
5		
6		
7		
8		
9		
10		
11		
12		
13		
14		
15	lsb	

WORD NAME: Firmware Version

WORD ID:	T6-15	RANGE:	N/A
SOURCE:	R/R	ACCURACY:	N/A
DESTINATION:	BC	lsb:	N/A

XMIT RATE            Periodic  
 SIGNAL TYPE        Discrete  
 UNITS                N/A

BIT NO.	DESCRIPTION
0	msb    Bit 0 - 7 is the unsigned integer firmware version (major) number Bit 0 is msb, Bit 7 is lsb
1	
2	
3	
4	
5	
6	
7	
8	Bit 8 - 15 is the unsigned integer firmware revision (minor) number Bit 8 is msb, Bit 15 is lsb
9	
10	
11	
12	
13	
14	
15	
15	lsb

WORD NAME:        TMATS File Revision

WORD ID:	T6-16	RANGE:	N/A
SOURCE:	R/R	ACCURACY:	N/A
DESTINATION:	BC	lsb:	N/A
XMIT RATE	Periodic		
SIGNAL TYPE	Discrete		
UNITS	N/A		

BIT NO.	DESCRIPTION
0	msb        Bit 0 - 15 is the unsigned integer TMATS file revision number
1	
2	
3	
4	
5	
6	
7	
8	
9	
10	

11  
 12  
 13  
 14  
 15     lsb

**A.3. Command Acceptability and Validity**

After boot-up, the R/R is always operating in one of the states defined herein. The current state of the R/R is returned in the STATUS transmit command. The acceptability (receive) and validity (transmit) of each of the commands are defined in [Table A-3](#) as follows.

- A     Always acceptable (receive) or valid (transmit)
- 1     Only acceptable when an volume is mounted in the R/R
- 2     INFO (transmit) validity is identified by the validity bits in word 1 and word 10. STATUS validity is identified by the validity bit in word 1.
- 3     The R/R time will only be updated by the TIME command when the Time Channel synchronization status as indicated by the HEALTH command Time Channel status word (Health command data word 2 bit 11) is “synchronization failure.”
- 4     Applies to Stop Command with Stop Replay option only when Play Live Data is active
- 5     Applies to Replay Command with Play Live option only when Play Live Data is not active
- N     Never acceptable (receive) or valid (transmit)

When the R/R receives an invalid command, it will remain in its current state and only set the “Last Receive Command Error” bit in the STATUS command transmit message (T6-01 bit 11).

<b>Table A-3. Military Standard 1553 Command Acceptability and Validity</b>													
<b>Command</b>	<b>State</b>												
	<b>BIT</b>	<b>BUSY</b>	<b>COMMAND ERROR</b>	<b>DECLASSIFY</b>	<b>DECLASSIFY ERROR</b>	<b>DECLASSIFY PASS</b>	<b>ERASE</b>	<b>FAIL</b>	<b>IDLE</b>	<b>PLAY</b>	<b>QUEUE (FIND)</b>	<b>RECORD</b>	<b>RECORD &amp; PLAY</b>
ASSIGN	N	A	A	A	A	A	A	A	A	A	A	A	A
BIT	N	N	A	N	A	A	N	A	A	N	N	N	N
DECLASSIFY	N	N	1	N	1	1	N	1	1	N	N	N	N
ERASE	N	N	1	N	1	1	N	1	1	N	N	N	N
EVENT (RECV)	N	A	A	N	A	A	N	A	A	A	A	A	A

EVENTS (XMIT)	A	A	A	A	A	A	A	A	A	A	A	A	A
HEALTH	A	A	A	A	A	A	A	A	A	A	A	A	A
INFO (RECV)	N	A	A	A	A	A	A	A	A	A	A	A	A
INFO (XMIT)	2	2	2	2	2	2	2	2	2	2	2	2	2
PAUSE	N	A	A	A	A	A	A	A	A	A	A	A	A
QUEUE	N	1	1	N	1	1	N	1	1	N	N	1	N
RECORD	N	1	1	N	1	1	N	1	1	1	1	N	N
REPLAY	N	1	1	N	1	1	N	1	5	5	N	1	5
RESET	A	A	A	A	A	A	A	A	A	A	A	A	A
RESUME	N	A	A	A	A	A	A	A	A	A	A	A	A
STATUS	2	2	2	2	2	2	2	2	2	2	2	2	2
STOP	N	N	N	N	N	N	N	N	4	A	N	A	A
SYNC	A	A	A	A	A	A	A	A	A	A	A	A	A
TIME	N	3	3	3	3	3	3	3	3	3	3	3	3

This page intentionally left blank.



## APPENDIX 6-B

### Definitions

**Broadcasting:** Transmits live or recorded Chapter 10 data packets over an Ethernet interface using UDP as specified by Section 10.3 of [Chapter 10](#).

**Channel:** A path for an electrical signal interface to or from an R/R. Data transported into or out of an R/R on a channel are not in Chapter 10 packets.

**Command processor:** The functional part of an R/R that accepts operational commands into its single command sequence.

**Command sequence:** A single sequence of Chapter 6 commands as defined in this standard.

**C&C:** Abbreviation for command and control of an R/R and includes status reporting and monitoring of the R/R.

**Downloading:** Transfers data from the drive attached to and controlled by an R/R to a host computer system.

**Drive:** An electronic or electro-mechanical drive interface used to transfer data to or from a single data storage device, such as a flash disk, rotating disk, CD, or DVD. Supports a single fixed or removable recording medium.

**Feature:** A data input or output channel, a packet input or output port, a drive, or the R/R itself. The Chapter 6 health monitoring system described below reports information about each feature.

**File:** A sequence of Chapter 10 packets stored on a storage device IAW the requirements of [Chapter 10](#).

**Looping:** An operation in which the signals connected to the input channels are reproduced on the output channels of the R/R. During looping the same time base is used to receive and subsequently transmit one or more data streams.

**Circuit-looping:** Mode of operation where data is moved from the input channels directly to the output channels with minimum latency between data reception and data transmission.

**Drive-looping:** Mode of operation where received data is first written to one or more drives and subsequently read back from the drive. Drive-looping may or may not include a fixed or programmable delay between the time data is written to and read from drive.

**Health attribute:** Each feature of an R/R has one or more status words that are monitored through the health reporting system described in this standard.

**Mandatory (M):** Required capability is the minimum necessary for Major Range and Test Facility Base (MRTFB) interoperability. Units that do not meet required capability are not compliant.

**Optional (O):** Optional requirements are not mandated by the standard and are not necessary for MRTFB interoperability.

**Port:** A control and/or data electrical interface to an R/R. Data transported into or out of an R/R on a port is wrapped in Chapter 10 packets.

**Pull-mode:** An operational mode where the rate at which data is received and processed is determined and controlled by the processing algorithm. A pull-mode operation typically reads previously recorded data from a drive device at the rate it establishes and can support.

**Push-mode:** An operational mode where the rate at which the data, usually live, is received and processed is not determined or controllable by the processing algorithm. A push-mode algorithm must “keep up” with the data or drop-outs will occur.

**R/R:** Recorder and/or reproducer that supports a single command sequence.

**Read-after-write:** An operation in which the same time base is used to write data to one or more drives while simultaneously reading all or a subset of the written data from the same drives. Read-after-write is synonymous with drive-looping. Read-after-write can be used to verify accuracy of the stored data. Data recorded erroneously can then be rewritten at another location.

**Read-while-write:** An operation in which separate time bases are used to write data to one or more drives while simultaneously reading all or a subset of the written data from the same drives from random locations.

**Recorder Configuration File:** Defines the structures and their relationships within the R/R and to configure the R/R for a specific operational scenario. The recorder configuration file contains the payload of the Chapter 10 computer-generated data packet, Format 1 setup record that is recorded as the first packet of each compliant Chapter 10 data file.

**Recording:** Writes live push-mode data to one or more recording drives.

**Recording drive:** A recording medium is a physical unit of data storage, such as a flash disk, card, DVD, or CD. Recording drives may or may not be removable from the support electronics that connect them to an R/R. A removable drive is referred to as RMM in [Chapter 10](#).

**Reproducing:** Retrieves previously recorded data from one or more drives and outputs the data in its original or modified format.

**Stream (or Channel ID Group):** The set or a named subset of compliant Chapter 10 packets produced within an R/R. A single stream may contain either live or recorded packets, but not both. The default stream is the set of packets produced by any enabled data input channel in the applicable recorder configuration file. A named stream may be the packets from any or a defined subset of enabled input channels in the applicable configuration.

**Uploading:** Transfers data from a host computer system into the drive controlled by an R/R.

**Volume:** A logical unit of data storage IAW [Chapter 10](#). Each volume must have at least one compliant directory block and zero or more compliant data files. A single drive may contain one or more volumes (see [Chapter 10](#), Subsection 10.5.1).

## APPENDIX 6-C

### **Citations**

National Institute of Standards and Technology. “Secure Hash Standard (SHS).” FIPS PUB 180-4. August 2015. May be superseded by update. Retrieved 17 May 2021. Available at <http://nvlpubs.nist.gov/nistpubs/FIPS/NIST.FIPS.180-4.pdf>.

**\*\*\*\* END OF CHAPTER 6 \*\*\*\***

## CHAPTER 7

### Packet Telemetry Downlink

<b>Acronyms</b> .....	<b>7-iii</b>
<b>Chapter 7. Packet Telemetry Downlink</b> .....	<b>7-1</b>
<b>7.1 Packet Telemetry</b> .....	<b>7-1</b>
<b>7.2 Encapsulation Packet Structure</b> .....	<b>7-2</b>
7.2.1 Encapsulation Packet Header.....	7-2
7.2.2 Encapsulation Packet Payload .....	7-3
7.2.3 Source Package Fragmentation.....	7-10
<b>7.3 Transport Packet Structure</b> .....	<b>7-10</b>
7.3.1 Transport Packet Header.....	7-11
7.3.2 Transport Packet Payload .....	7-12
<b>7.4 Asynchronous Encapsulation Packet Multiplexing</b> .....	<b>7-13</b>
7.4.1 Standard Transport Packet Segmentation .....	7-13
7.4.2 Low-Latency Encapsulation Packet Insertion .....	7-14
<b>7.5 Transport Packet Transport</b> .....	<b>7-14</b>
<b>Appendix 7-A. Extended Binary Golay Code</b> .....	<b>A-1</b>
<b>A.1. Introduction</b> .....	<b>A-1</b>
<b>A.2. Encoding Golay Code</b> .....	<b>A-2</b>
<b>A.3. Decoding Golay Code</b> .....	<b>A-2</b>
<b>A.4. Decoding the Golay Code (8,1,3)</b> .....	<b>A-4</b>
<b>Appendix 7-B. Citations</b> .....	<b>B-1</b>

### List of Figures

Figure 7-1. Packet Telemetry Overview.....	7-1
Figure 7-2. Encapsulation Packet Structure.....	7-2
Figure 7-3. EP Header Protected Fields (Unencoded).....	7-2
Figure 7-4. Fill Source Packet Payload .....	7-3
Figure 7-5. Test Counter Source Packet Payload (Unencoded) .....	7-4
Figure 7-6. Chapter 11 General Packet Structure .....	7-5
Figure 7-7. Chapter 11 Source Packet Structure .....	7-5
Figure 7-8. PT Chapter 11 Header Protected Fields (Unencoded).....	7-6
Figure 7-9. Chapter 11 Source Packet Header Unprotected Fields .....	7-6
Figure 7-10. Raw Ethernet MAC Frame Source Packet Structure .....	7-8
Figure 7-11. IPv4 Source Packet Structure.....	7-8
Figure 7-12. IPv6 Source Packet Structure.....	7-8

Figure 7-13. Chapter 24 TmNSMessage Structure..... 7-8  
Figure 7-14. TmNSMessage Source Packet Structure ..... 7-9  
Figure 7-15. TmNSMessage SP Header Protected Fields (Unencoded) ..... 7-9  
Figure 7-16. TmNSMessage SP Header Unprotected Fields ..... 7-9  
Figure 7-17. Source Packet Fragmentation and Reassembly ..... 7-10  
Figure 7-18. Transport Packet Overview..... 7-10  
Figure 7-19. Transport Packet Structure..... 7-11  
Figure 7-20. Transport Packet Header Unprotected Fields ..... 7-11  
Figure 7-21. Transport Packet Header Protected Fields (Unencoded) ..... 7-11  
Figure 7-22. Transport Packet Payload Structure..... 7-12  
Figure 7-23. Start of Encapsulation Packet Overview..... 7-13  
Figure 7-24. Standard Transport Packet Segmentation Overview ..... 7-13  
Figure 7-25. Transport Packet Segmentation with LLEPs Overview ..... 7-14  
Figure 7-26. Splitting a Transport Packet into Two Segments..... 7-15  
Figure 7-27. PCM Minor Frame With Two Transport Packet Segments..... 7-15  
Figure A-1. Golay Code Encoding and Decoding..... A-1

## Acronyms

EP	encapsulation packet
IP	Internet Protocol
IPv4	Internet Protocol, Version 4
IPv6	Internet Protocol, Version 6
LLEP	low-latency encapsulation packet
MAC	media access control
msb	most significant bit
PCM	pulse code modulation
SP	source packet
TmNS	Telemetry Network Standard
TP	transport packet

This page intentionally left blank.



## CHAPTER 7

### Packet Telemetry Downlink

This standard defines the method for transporting variable-length, well-defined data formats in a Chapter 4 pulse code modulation (PCM) stream.

#### 7.1 Packet Telemetry

Packet telemetry defines the method for asynchronously inserting data from one or more data streams into PCM minor frames. This standard defines various source packet (SP) types that are used to encapsulate well-defined data formats, including:

- Chapter 11 packets;
- Chapter 24 TmNSMessages;
- Ethernet frames.

An SP is encapsulated into an integral number of encapsulation packets (EPs); nominally each EP contains only one SP. Different SP types may be multiplexed simultaneously into a single, logical stream of EPs. The encapsulation packet stream is then segmented into fixed-length transport packets (TPs), each of which is inserted into a single PCM minor frame. While a TP may be segmented and interspersed with PCM data within a PCM minor frame, each PCM minor frame shall contain only one TP. A low-latency encapsulation packet (LLEP) mechanism allows for the insertion of one or more EPs with low-latency requirements into the transmission of a long EP. Specific structure-critical elements are protected using a Golay code; see [Appendix 7-A](#) for details. [Figure 7-1](#) provides an overview of the entire packet telemetry encapsulation process.

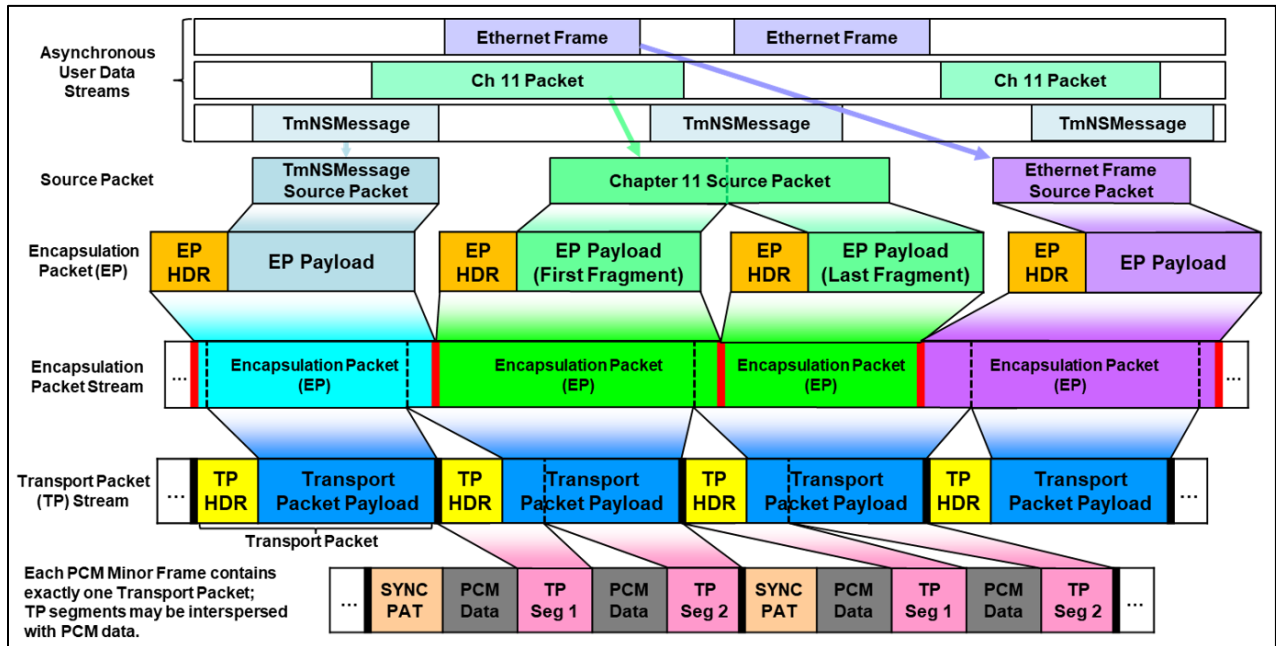





Figure 7-1. Packet Telemetry Overview

**NOTE**  An SP may be fragmented into multiple EPs where each EP’s payload contains a fragment of the SP. Subsection [7.2.3](#) describes SP fragmentation.

A TP may be segmented for insertion into a PCM minor frame. A single PCM minor frame may contain multiple TP segments. See Section [7.5](#) for more details.

**NOTE**  The IRIG 106-15 restricted a PCM minor frame to a single, contiguous, unsegmented TP. The current standard supports a single, contiguous or segmented TP per PCM minor frame.

**NOTE**  [Chapter 9](#) supports defining TP segments contained within a PCM minor frame.

## 7.2 Encapsulation Packet Structure

An EP shall include a header and a payload as shown in [Figure 7-2](#).

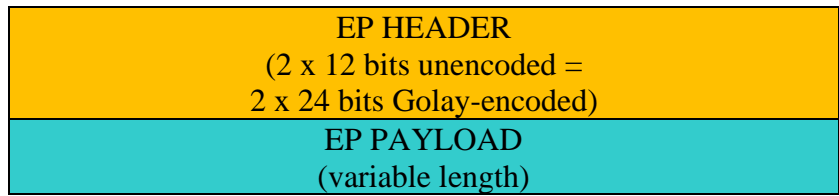

Figure 7-2. Encapsulation Packet Structure

### 7.2.1 Encapsulation Packet Header

The EP header shall consist of two 12-bit words and shall be encoded as two 24-bit Golay code words prior to insertion into the EP, encoded most significant bit (msb) first and in the word order as shown in [Figure 7-3](#).

	11	10	9	8	7	6	5	4	3	2	1	0
Word 0	CRC	Res	Content				Fragment		Length (15 – 12)			
Word 1	Length (11 – 0)											

Figure 7-3. EP Header Protected Fields (Unencoded)

The EP header consists of the following fields.

- CRC (bit 23). A CRC trailer is present on this packet. A 16-bit CRC ins included at the end of the packet and is included in the packet length. The CRC shall be calculated as a CRC-16-ANSI CRC as specified in [Chapter 4](#) Subsection 4.3.3.
- Res (bit 22). Reserved. This bit shall be set to zero (e.g., 2’b0) on transmission; ignored on reception.
- Content (bits 21 – 18). The ST packet type field shall specify the type of SP contained in the EP payload (see Subsection [7.2.2](#) for details).
  - 4’b0000: Fill SP

- 4'b0001: Application-Specific SP
  - 4'b0010: Test Counter SP
  - 4'b0011: Chapter 11 SP
  - 4'b0100: Raw Ethernet Media Access Control (MAC) Frame SP
  - 4'b0101: Internet Protocol (IP) SP
  - 4'b0110: Chapter 24 TmNSMessage SP
  - 4'b0111 –
  - 4'b1111: Reserved
- Fragment (bits 17 – 16). The SP fragmentation flags shall identify whether the EP payload contains a complete SP or a fragment.
    - 2'b00: Complete SP
    - 2'b01: First Fragment of an SP
    - 2'b10: Middle Fragment of an SP
    - 2'b11: Last Fragment of an SP
  - Length (bits 15 – 0). The EP length field shall provide the length (in bytes) of the EP payload (note the EP header length is not included in the EP length). If an SP exceeds the maximum EP length, the SP must be fragmented using multiple EPs as specified in Subsection [7.2.3](#).

7.2.2 Encapsulation Packet Payload

The EP payload shall contain either a complete SP or an SP fragment; the Content field identifies the SP type. The following subsections contain a detailed description for each SP type.

7.2.2.1 Fill Source Packet

If no SPs are available for embedding into an EP stream, fill SPs shall be generated and inserted into the EP stream to assure a constant data flow to the PCM stream. Each fill SP byte shall be set to 8'b10101010 (0xAA) as shown in [Figure 7-4](#). A fill SP size may be an arbitrary integral number of bytes.

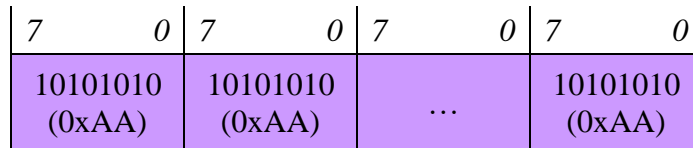

Figure 7-4. Fill Source Packet Payload

7.2.2.2 Application-Specific Source Packet

This standard does not define the format of application-specific SPs. While application-specific SPs are allowed, they shall not be used to encapsulate data that conforms to another defined SP format (e.g., Chapter 11 packets, Chapter 24 TmNSMessages, Ethernet data, etc.).

7.2.2.3 Test Counter Source Packet

The test counter SP is defined as a free-running 12-bit counter. The test counter SP shall consist of one 12-bit word and shall be encoded as one 24-bit Golay code word, encoded msb first as shown in [Figure 7-5](#).

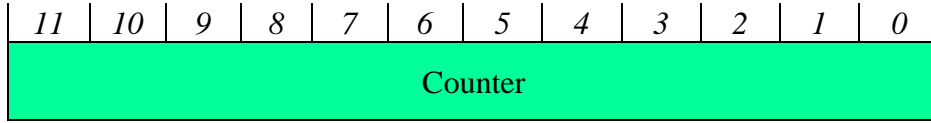



Figure 7-5. Test Counter Source Packet Payload (Unencoded)

 <p><b>NOTE</b></p>	<p>The test counter SP is optional and this standard does not specify the transmission rate.</p>
--	--

7.2.2.4 Chapter 11 Source Packet

The Chapter 11 SP structure contains a slightly modified version of a Chapter 11 packet. The primary differences between the original Chapter 11 packet header and the Chapter 11 SP header are:

- The Chapter 11 SP does not contain the packet sync pattern field;
- The Chapter 11 SP does not contain the packet length field;
- The Chapter 11 SP contains a packet trailer bytes field;
- The Chapter 11 SP may contain fewer fill bytes than the original Chapter 11 packet header.

Subsection [7.2.2.4.1](#) describes Chapter 11 SP composition. Subsection [7.2.2.4.2](#) describes Chapter 11 SP reassembly.

[Figure 7-6](#) shows the Chapter 11 general packet structure and [Figure 7-7](#) shows the Chapter 11 SP structure.

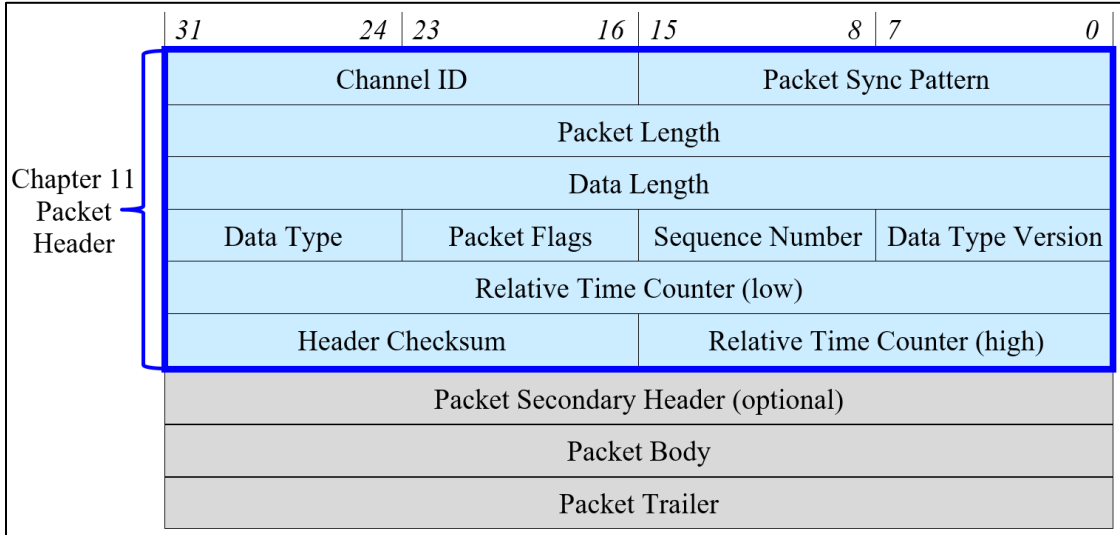

Figure 7-6. Chapter 11 General Packet Structure

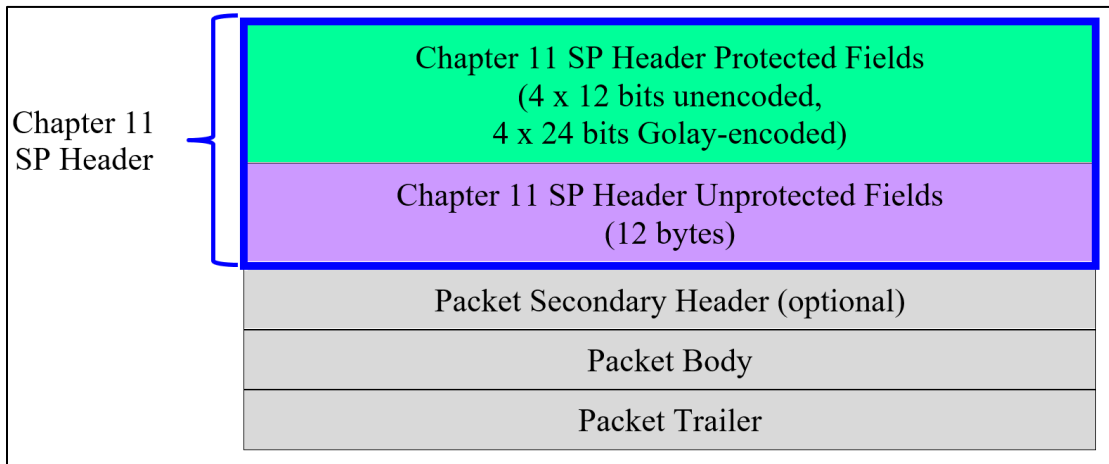

Figure 7-7. Chapter 11 Source Packet Structure

The original Chapter 11 packet header fields are partitioned into two groups for the Chapter 11 SP header:

- Golay-encoded protected fields that protect structure-critical header information;
- Unprotected fields.

The Chapter 11 SP header protected fields shall consist of four 12-bit words and shall be encoded as four 24-bit Golay code words prior to insertion into the EP payload, encoded msb first and in the word order indicated in [Figure 7-8](#).

	11	10	9	8	7	6	5	4	3	2	1	0
Word 0	Reserved (0)								Channel ID (15 – 12)			
Word 1	Channel ID (11 – 0)											
Word 2	Packet Trailer Bytes <sup>1</sup> (4 – 0)				Data Length <sup>2</sup> (18 – 12)							
Word 3	Data Length <sup>2</sup> (11 – 0)											
<sup>1</sup> The packet trailer bytes shall contain the sum of the Chapter 11 SP’s secondary header length, fill bytes length, and packet checksum length. See Subsection <a href="#">7.2.2.4.1</a> . <sup>2</sup> The Data Length field size limit of 19 bits is sufficient for all Chapter 11 packet sizes, except Computer-Generated Data Packet, Format 1 setup record. See Subsection <a href="#">7.2.2.4.1</a> .												

Figure 7-8. PT Chapter 11 Header Protected Fields (Unencoded)

The Chapter 11 SP header unprotected fields shall consist of 12 bytes as shown in [Figure 7-9](#).

31	24	23	16	15	8	7	0
Data Type		Packet Flags		Sequence Number		Data Type Version	
Relative Time Counter (low)							
Header Checksum				Relative Time Counter (high)			

Figure 7-9. Chapter 11 Source Packet Header Unprotected Fields

7.2.2.4.1 Chapter 11 Source Packet Composition

The following steps shall be executed prior to constructing a Chapter 11 SP.

1. Truncate the number of packet trailer fill bytes to no more than three bytes. The number of fill bytes contained in a Chapter 11 SP shall be restricted to a maximum of three bytes.
2. Update the header packet length. If the packet trailer fill bytes were truncated, the packet length shall be updated accordingly.
3. Calculate a new header checksum. If the packet trailer fill bytes were truncated, the header checksum shall be recalculated using the updated header packet length.
4. Calculate a new data checksum (if the packet trailer contains a data checksum). If the packet trailer fill bytes were truncated and non-zero packet trailer fill bytes were removed, the data checksum shall be recalculated using the truncated packet trailer fill bytes.

Once these steps are executed, the Chapter 11 packet header shall be divided into the protected and unprotected fields as described above. The packet trailer bytes field shall contain the sum of the Chapter 11 SP’s secondary header length, fill bytes length (adjusted to a maximum of three bytes), and data checksum length.

If the size of the Chapter 11 packet exceeds the 19-bit limit, the data length shall be set to modulo 524,288 ( $2^{19}$ ) of the Chapter 11 packet length and multiple Chapter 11 EPs shall be generated using the SP fragmentation method described in Subsection [7.2.3](#).

	<p>Compared to the original Chapter 11 packet, the resulting Chapter 11 SP is either identical, or due to fill byte truncation, shorter than the original Chapter 11 packet. If fill byte truncation occurred, the packet length and packet header checksum will be recalculated and the data checksum may be recalculated; however, the Chapter 11 SP's data content remains unchanged from the original Chapter 11 packet.</p>
---	--

**7.2.2.4.2 Chapter 11 Packet Reassembly**

A Chapter 11 packet may be reassembled once an entire Chapter 11 SP has been reassembled from one or more EPs – see Subsection [7.2.3](#) for details. The Chapter 11 packet header shall be reassembled after Golay-decoding is performed on the Chapter 11 SP header's protected fields. The following steps shall be executed.

1. The reassembled Chapter 11 packet sync pattern shall be set to 0xEB25 (16'b1110101100100101) as specified in [Chapter 11](#).
2. The reassembled Chapter 11 packet's packet length shall be calculated as follows:

$$Packet\ Length = \sum (length\ in\ each\ EP\ Fragment\ Header)$$

3. The reassembled Chapter 11 packet's data length shall be calculated as follows:

$$Data\ Length = calculated\ Packet\ Length - Packet\ Header\ Length\ (24\ bytes) - Packet\ Trailer\ Bytes$$

Perform this comparison to validate the reassembled Chapter 11 packet's data length:

$$Chapter\ 11\ SP's\ Data\ Length = calculated\ Data\ Length\ modulo\ 524,288$$

	<p>The modulo 524,288 (<math>2^{19}</math>) is required to accommodate original Chapter 11 packets that are larger than 524,288 bytes.</p>
---	--

The following steps may be performed to verify the integrity of the reassembled Chapter 11 packet.

1. The packet header checksum should be calculated and compared to the reassembled Chapter 11 packet header checksum.
2. If present, the data checksum in the packet trailer should be calculated and compared to the reassembled Chapter 11 packet data checksum in the packet trailer.

	<p>If fill byte truncation occurred during Chapter 11 SP composition, the reassembled Chapter 11 packet length and packet header checksum will differ and the data checksum may differ from the original Chapter 11 packet; however, the reassembled Chapter 11 packet's data content remains unchanged from the original Chapter 11 packet.</p>
---	--

7.2.2.5 Raw Ethernet Media Access Control Frame Source Packet

The raw Ethernet MAC frame SP contains one physical-layer MAC frame, starting with the MAC destination address and ending with the frame check sequence inclusive, as shown in [Figure 7-10](#). The raw Ethernet MAC frame SP can contain any kind of message data, IPv4, IPv6, and jumbo messages. No extra protection is applied to the raw Ethernet MAC frame SP.

Destination MAC Address 6 bytes	Source MAC Address 6 bytes	LLC (opt) 3 – 9 bytes	Ethertype 2 bytes	Payload 46 – 1500 bytes	Frame Check Sequence 4 bytes
------------------------------------	-------------------------------	--------------------------	----------------------	----------------------------	---------------------------------

Figure 7-10. Raw Ethernet MAC Frame Source Packet Structure

7.2.2.6 Internet Protocol Source Packet

The IP SP contains one IPv4 as shown in [Figure 7-11](#) or one IPv6 packet as shown in [Figure 7-12](#). No extra protection is applied to the IP SP.

IPv4 Header (20 – 36 bytes)	IPv4 Payload (max payload length is 65,535 bytes – header size)
--------------------------------	--

Figure 7-11. IPv4 Source Packet Structure

IPv6 Header (40 bytes)	IPv6 Payload (max payload length is 65,536 bytes)
---------------------------	--

Figure 7-12. IPv6 Source Packet Structure

7.2.2.7 TmNSMessage Source Packet

The TmNSMessage SP structure contains a slightly modified version of a Chapter 24 TmNSMessage. [Figure 7-13](#) shows the Chapter 24 TmNSMessage structure and [Figure 7-14](#) shows the TmNSMessage SP structure.

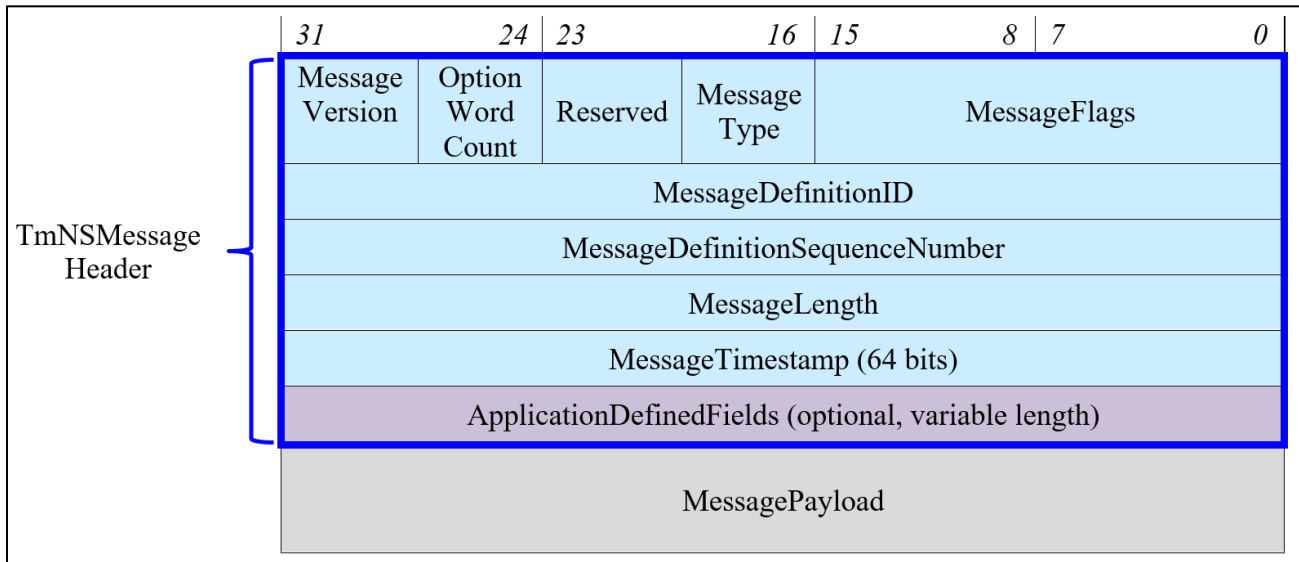

Figure 7-13. Chapter 24 TmNSMessage Structure



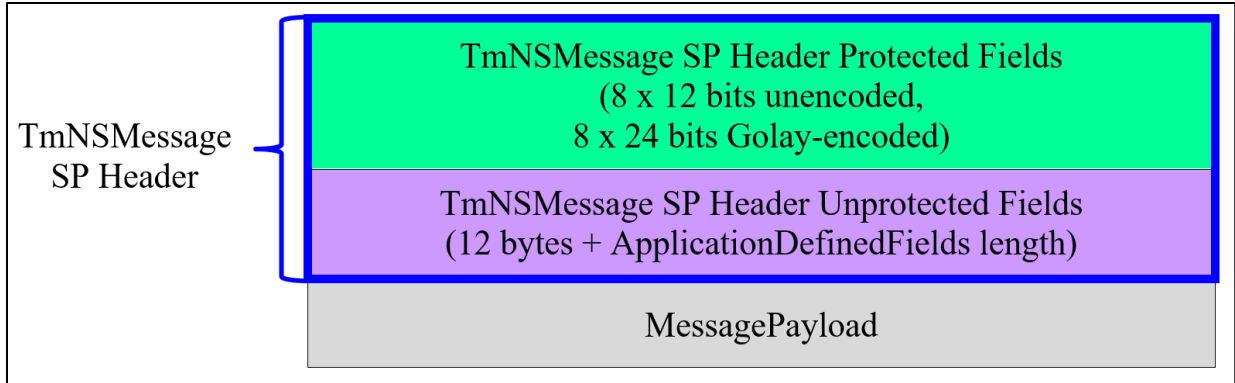

Figure 7-14. TmNSMessage Source Packet Structure

The original Chapter 24 TmNSMessage header fields are partitioned into two groups for the TmNSMessage SP header:

- Golay-encoded protected fields that protect structure-critical header information;
- Unprotected fields (those fields not part of the protected fields).

The TmNSMessage SP header protected fields shall consist of eight 12-bit words and shall be encoded as eight 24-bit Golay code words prior to insertion into the EP payload, encoded msb first and in the word order shown in [Figure 7-15](#).

	11	10	9	8	7	6	5	4	3	2	1	0
Word 0	Message Version				OptionWordCount				MessageFlags (3 – 0)			
Word 1	MessageFlags (15 – 4)											
Word 2	Reserved				MessageDefinitionID (31 – 24)							
Word 3	MessageDefinitionID (23 – 12)											
Word 4	MessageDefinitionID (11 – 0)											
Word 5	MessageType				MessageLength (31 – 24)							
Word 6	MessageLength (23 – 12)											
Word 7	MessageLength (11 – 0)											

Figure 7-15. TmNSMessage SP Header Protected Fields (Unencoded)

The TmNSMessage SP header unprotected fields shall consist of 12 bytes plus the ApplicationDefinedFields (if present) as shown in [Figure 7-16](#).

31	24	23	16	15	8	7	0
MessageDefinitionSequenceNumber							
MessageTimestamp (64 bits)							
ApplicationDefinedFields (optional, variable length)							

Figure 7-16. TmNSMessage SP Header Unprotected Fields

### 7.2.3 Source Package Fragmentation

If an SP requires fragmentation, each EP containing an SP fragment shall be inserted sequentially into the TP stream. Only LLEPs can be inserted in between an SP's sequence of fragments by using the LLEP encapsulation mechanism as described in Subsection 7.4.2. While fragmentation is necessary if an SP's size is greater than or equal to 64 kilobytes, any SP may be fragmented. Figure 7-17 shows SP fragmentation and reassembly.

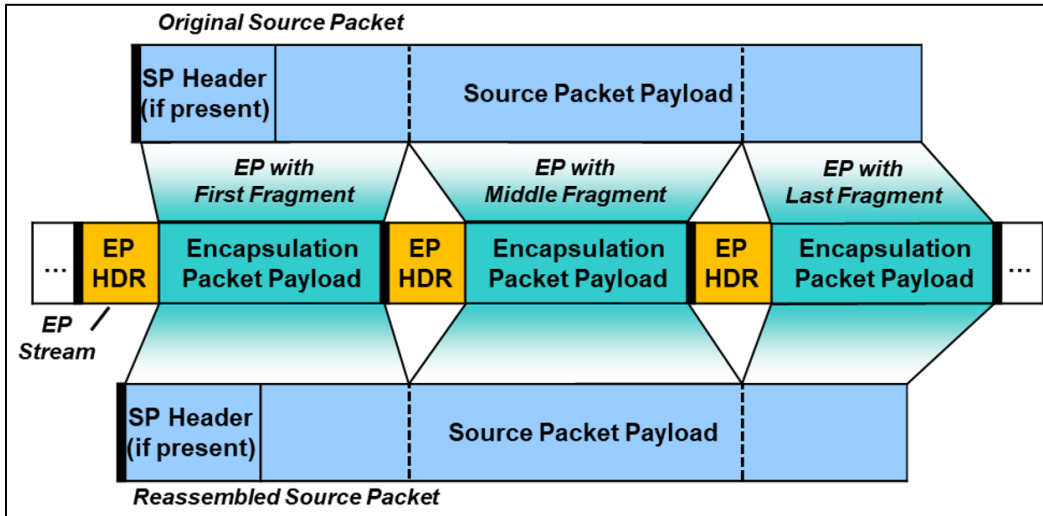

Figure 7-17. Source Packet Fragmentation and Reassembly

### 7.3 Transport Packet Structure

The TP is a fixed-length frame of data that contains a segment of a continuous EP stream as represented in Figure 7-18.

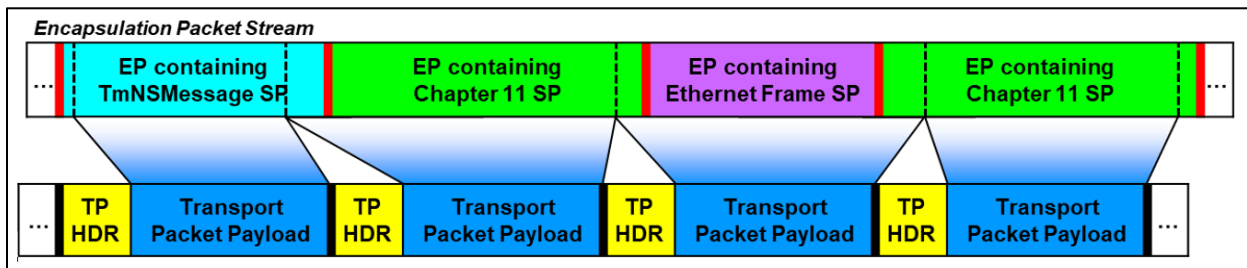

Figure 7-18. Transport Packet Overview

A TP consists of a header and a payload as shown in Figure 7-19.

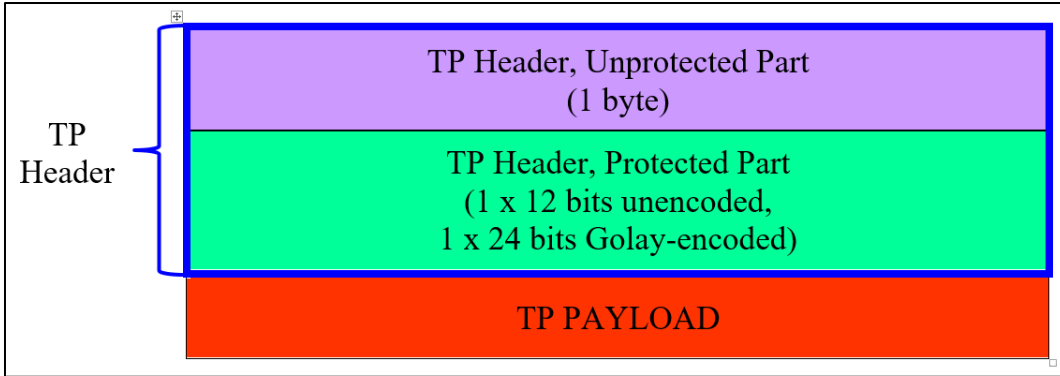

Figure 7-19. Transport Packet Structure

### 7.3.1 Transport Packet Header

The TP header fields are partitioned into two groups:

- Unprotected fields that contains stream and version information;
- Golay-encoded protected fields that protect structure-critical header information.

The unprotected fields shall precede the Golay-encoded protected fields.

#### 7.3.1.1 Transport Packet Header Unprotected Fields

The TP header unprotected fields shall consist of one byte as shown in [Figure 7-20](#).

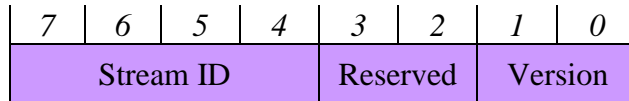

Figure 7-20. Transport Packet Header Unprotected Fields

The TP header unprotected fields are defined below.

- Stream ID (bits 7 – 4). The stream ID identifies an application-specific stream.
- Reserved (bits 3 – 2). All bits shall be set to zero (e.g., 2'b00) on transmission; ignored on reception.
- Version (bits 1 – 0). The TP version:
  - 2'b00: Version 1
  - 2'b01: Reserved
  - 2'b10: Reserved
  - 2'b11: Reserved

#### 7.3.1.2 Transport Packet Header Protected Fields

The TP header protected fields shall consist of one 12-bit word and shall be encoded as one 24-bit Golay code word prior to insertion into the TP payload, encoded msb first and in the word order indicated in [Figure 7-21](#).

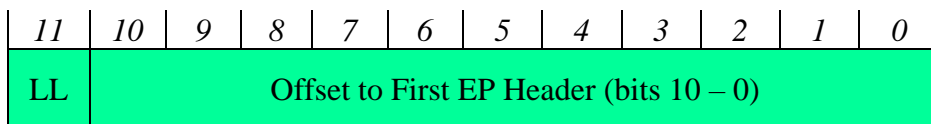

Figure 7-21. Transport Packet Header Protected Fields (Unencoded)

The TP header protected fields are defined below.

- LL: LLEP Exists (bit 11) – see Subsection [7.4.2](#) for LLEP details
  - 1'b1: indicates the TP payload contains one or more optional LLEPs and the closing LLEP end byte.
  - 1'b0: indicates no LLEP and no LLEP end byte exist in the TP payload.
- Offset to First EP Header (bits 10 – 0). If a TP contains at least one EP header, this field specifies a byte offset to the first byte of that first EP header. Otherwise, all bits shall be set to one (11'b1111111111). The value is relative to the first data byte following the TP header (e.g., the value of zero represents the first byte following the TP header). See Subsection [7.4.1](#) for additional information.

### 7.3.2 Transport Packet Payload

The TP payload contains zero or more partial or complete EPs as illustrated in [Figure 7-22](#). Optional LLEPs may be inserted in the TP payload after the TP header (see Subsection [7.4.2](#) for LLEP details).

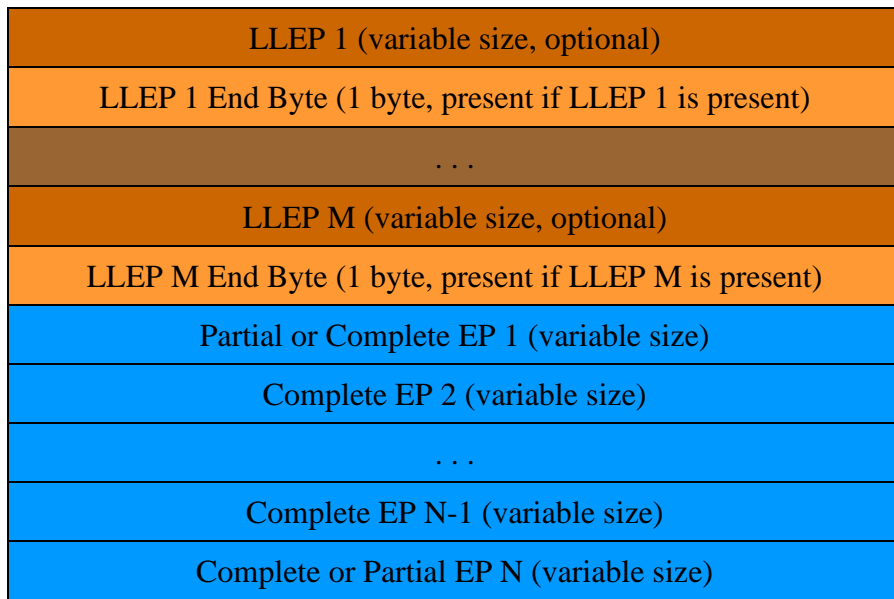

Figure 7-22. Transport Packet Payload Structure

#### 7.3.2.1 Encapsulation Packets in Transport Packet Payload

The TP payload contains zero or more partial or complete EPs as illustrated in [Figure 7-22](#) (blue fields). The first and last EP may be either partial or complete EPs. See Subsection [7.4.1](#) for details.

#### 7.3.2.2 Low-Latency Encapsulation Packet

An LLEP is an EP having low-latency transmission requirements as described in Subsection [7.4.2](#). If one or more LLEPs exist in a TP, the first LLEP is placed immediately after the TP header.

### 7.3.2.3 Low-Latency Encapsulation Packet End Byte

For each LLEP contained within a TP, an LLEP end byte shall immediately follow the LLEP. The LLEP end byte identifies if another LLEP follows or if this is the last LLEP in the TP. The LLEP end byte encoding is as follows.

- 8b'11111111 (0xFF) indicates that another LLEP immediately follows this byte.
- 8b'00000000 (0x00) indicates there are no more LLEPs in this TP. The byte following this end byte is the first byte of the first EP, unless the LLEP end byte is the TP's last byte (i.e., there are no EPs in the TP's payload).

## 7.4 Asynchronous Encapsulation Packet Multiplexing

A TP contains asynchronously inserted EPs; one EP may span multiple TPs. The EP stream contains a continuous series of EPs; the start of an EP must immediately follow the last byte of a previous EP as illustrated in [Figure 7-23](#).

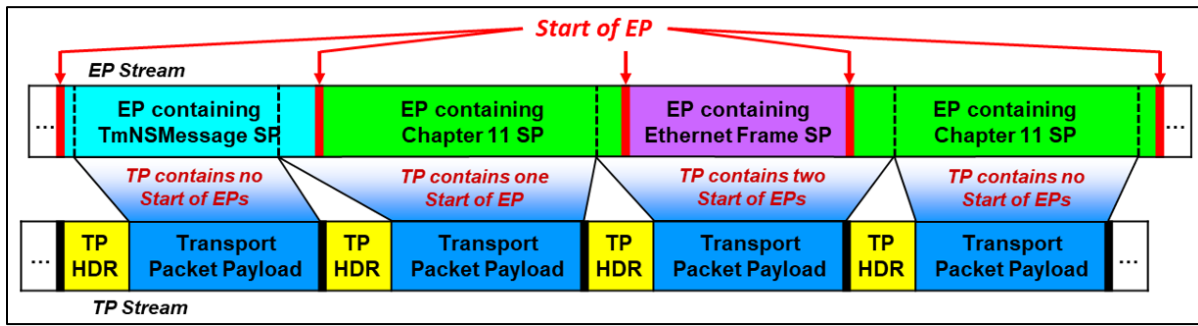

Figure 7-23. Start of Encapsulation Packet Overview

### 7.4.1 Standard Transport Packet Segmentation

If the start of an EP is contained within a TP, the TP header shall contain the offset to the EP's first byte. If there are multiple EPs in the TP, the TP header shall contain the offset to the start of the first EP. Since one EP may span multiple TPs, the TP header may not contain an offset to an EP. See Subsection [7.3.1.2](#) for details. An overview of the standard TP segmentation mechanism is shown in [Figure 7-24](#).

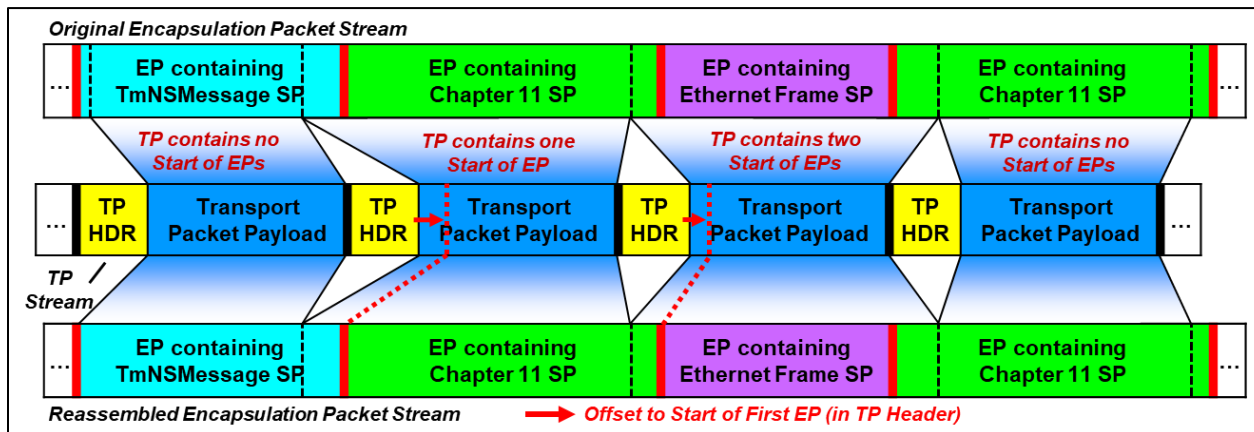

Figure 7-24. Standard Transport Packet Segmentation Overview

### 7.4.2 Low-Latency Encapsulation Packet Insertion

The transmission of long EPs may cause too long of latency for some critical data. Therefore, an LLEP mechanism is provided, allowing the insertion of one or more EPs with low-latency requirements within the transmission of a long EP. The interrupted long EP is resumed immediately after the LLEP part of the TP.

An LLEP shall not span multiple TPs. When constructing a TP, an entire LLEP and associated end byte shall fit into the remaining space in the TP. [Figure 7-25](#) shows an overview of a TP with LLEPs.

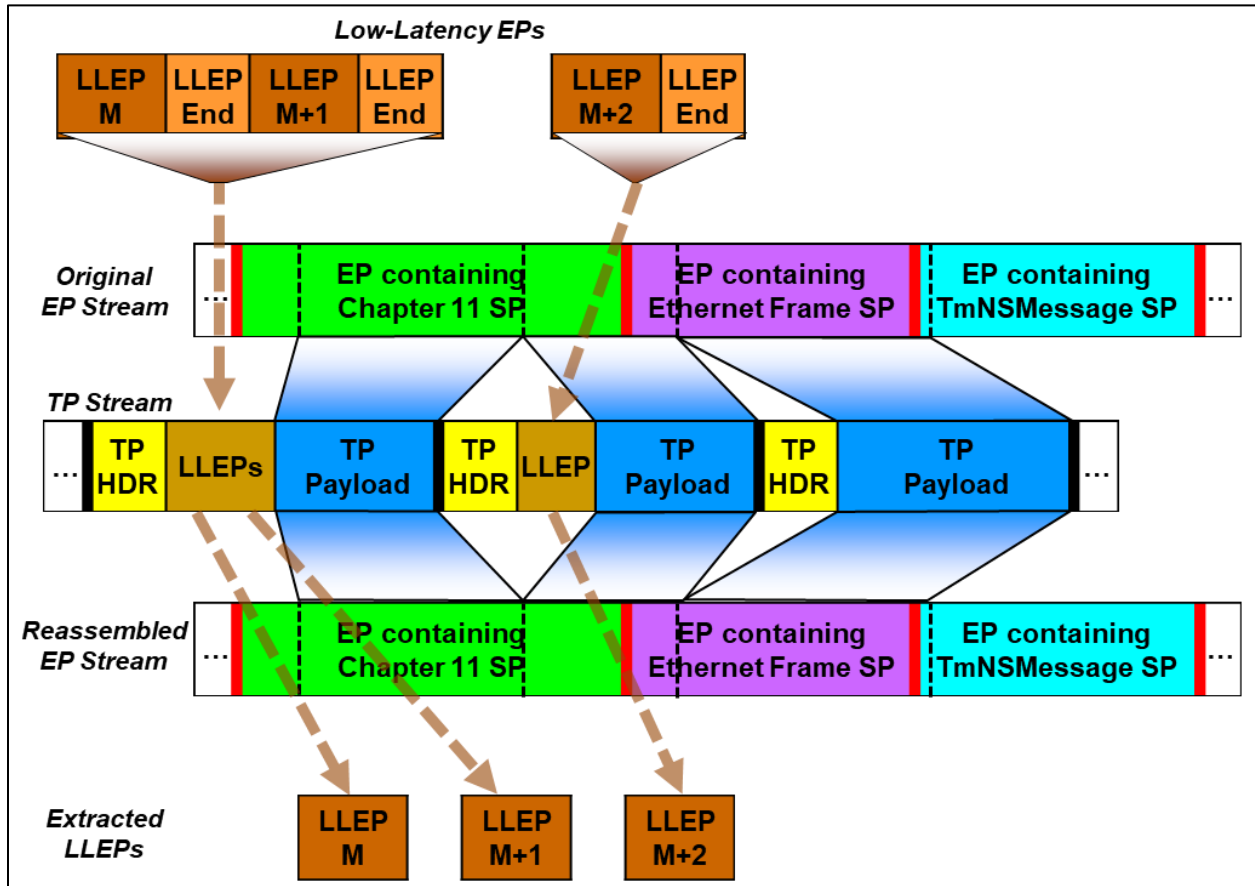



Figure 7-25. Transport Packet Segmentation with LLEPs Overview

<p><b>NOTE</b></p> 	<p>The offset to the first EP in the TP header is not necessarily pointing immediately after the LLEP.</p>
--	--

### 7.5 Transport Packet Transport

To insert a TP into a Chapter 4 PCM minor frame, each TP segment is byte-aligned and inserted into the PCM minor frame as a byte stream with the msb first (as shown in [Figure 7-26](#)). If a TP segment's size is not an integral number of bytes, the remaining bits at the end of the TP segment are considered fill bits and should be ignored. Each PCM minor frame shall contain

exactly one complete TP structure; [Figure 7-27](#) shows a PCM minor frame with two TP segments.

**NOTE**  To assist with detecting bit errors, this standard recommends adding a CRC-32 to the PCM Minor Frame as specified in [Chapter 4](#).

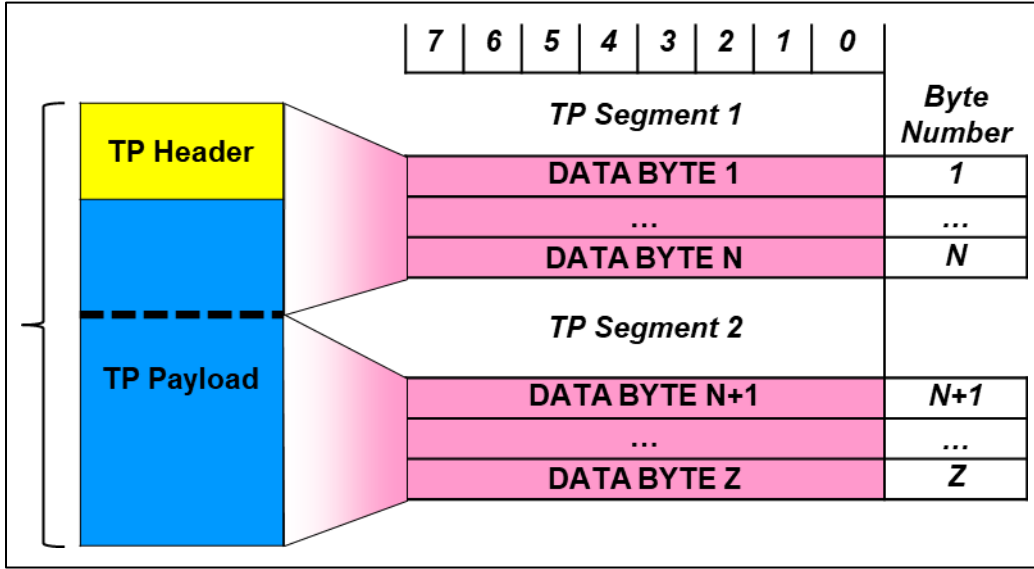



Figure 7-26. Splitting a Transport Packet into Two Segments

**NOTE**  Any TP segmentation does not affect how the TP header's offset to the first EP header is used to index into the TP byte array.

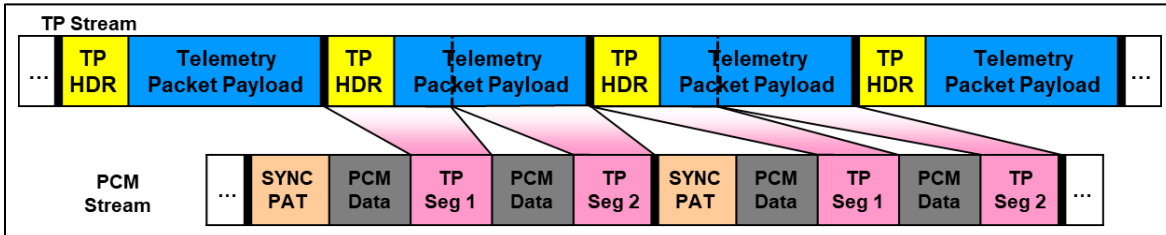



Figure 7-27. PCM Minor Frame With Two Transport Packet Segments

If no TPs are available for transmission, EPs with fill SPs shall be inserted into TPs for subsequent insertion into the PCM minor frame.

**NOTE**  All PCM minor frame overhead words such as the Chapter 4 sync pattern or subframe counters are not considered part of a TP.

This page intentionally left blank.



## APPENDIX 7-A

### Extended Binary Golay Code

#### A.1. Introduction

A single-bit transmission error may cause excessive data loss in packet telemetry. If the error occurs in identification or structure length fields, the error can lead to misinterpretation of a packet or a loss of a series of packets.

To help mitigate potential errors, a self-correcting coding called extended binary Golay code is applied to structure-critical elements in a packet telemetry stream. This additional coding provides protection of the packet identification and length information and supports correction of up to 3-bit transmission errors in a 24-bit sequence. This is accomplished by encoding 12-bit words into 24-bit words.

This extended binary Golay code,  $G_{24}$  (sometimes just called the “Golay code” in finite group theory) encodes 12 bits of data in a 24-bit word in such a way that any 3-bit errors can be corrected or any 7-bit errors can be detected. In standard code notation the codes have parameters (24, 12, 8) corresponding to the length of the code words, the dimension of the code, and the minimum Hamming distance between two code words, respectively.<sup>1</sup> The coding and decoding of the Golay code is illustrated in [Figure A-1](#).

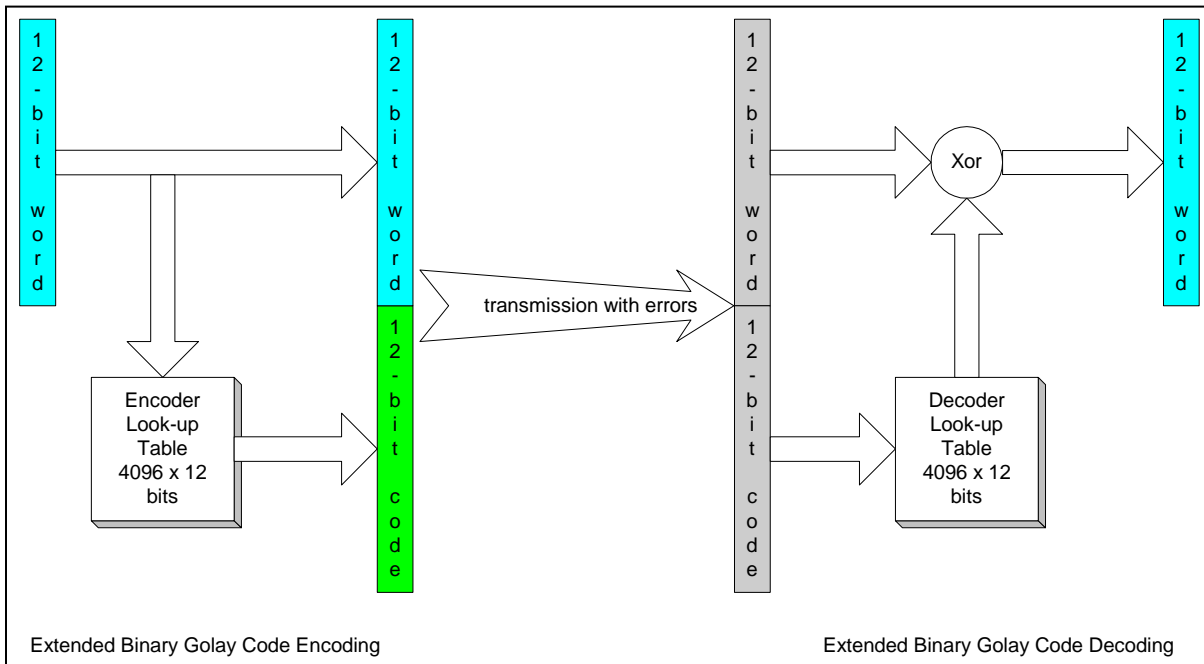

Figure A-1. Golay Code Encoding and Decoding

The following sections are C code reference implementation and define the required behavior of encoding and decoding the extended binary Golay code.

<sup>1</sup> Golay, Marcel J. E. *Notes on Digital Coding* in “Proceedings of the IRE,” 1949, v.37, p. 657.

## A.2. Encoding Golay Code

The extended binary Golay code encoding lookup table can be initialized by the `InitGolayEncode()` function, and the encoding can be done by the `Encode(v)` macro of the following C code.

```
#define GOLAY_SIZE      0x1000

// Generator matrix : parity sub-generator matrix P :

uint16_t G_P[12] = {
    0xc75, 0x63b, 0xf68, 0x7b4,
    0x3da, 0xd99, 0x6cd, 0x367,
    0xdc6, 0xa97, 0x93e, 0x8eb
};

/* Binary representation
  1 1 0 0   0 1 1 1   0 1 0 1
  0 1 1 0   0 0 1 1   1 0 1 1
  1 1 1 1   0 1 1 0   1 0 0 0
  0 1 1 1   1 0 1 1   0 1 0 0
  0 0 1 1   1 1 0 1   1 0 1 0
  1 1 0 1   1 0 0 1   1 0 0 1
  0 1 1 0   1 1 0 0   1 1 0 1
  0 0 1 1   0 1 1 0   0 1 1 1
  1 1 0 1   1 1 0 0   0 1 1 0
  1 0 1 0   1 0 0 1   0 1 1 1
  1 0 0 1   0 0 1 1   1 1 1 0
  1 0 0 0   1 1 1 0   1 0 1 1
*/
uint32_t      EncodeTable[ GOLAY_SIZE ];      // Golay encoding table

// encode a 12-bit word to a 24-bit Golay code word
#define Encode(v) EncodeTable[v&0xffff]

// initialize the Golay encoding lookup table
void InitGolayEncode( void )
{
    for( uint32_t x=0; x < GOLAY_SIZE; x++ ) {
        // generate encode LUT
        EncodeTable[x]=(x<<12);
        for( uint32_t i=0; i<12; i++ ) {
            if( (x>>(11-i)) & 1 )
                EncodeTable[x] ^= G_P[i];
        }
    }
}
```

## A.3. Decoding Golay Code

The extended binary Golay code decoding lookup tables can be initialized by the `InitGolayDecode()` function of the following C code. The 12-bit decoded and corrected word can be calculated by the `Decode(v)` macro from a 24-bit code word. The number of error bits in a 24-bit code word can be gotten by the `Error(v)` macro from a 24-bit code word.

```

#define      GOLAY_SIZE          0x1000

uint16_t SyndromeTable[ GOLAY_SIZE ];    // Syndrome table
uint16_t CorrectTable[ GOLAY_SIZE ];     // correction table
uint8_t  ErrorTable[ GOLAY_SIZE ];       // number of error bits table

#define Syndrome2(v1,v2)      (SyndromeTable[v2]^(v1))
#define Syndrome(v)          Syndrome2(((v)>>12)&0xfff,(v)&0xfff)
#define Errors2(v1,v2)       ErrorTable[Syndrome2(v1,v2)]
#define Decode2(v1,v2)       ((v1)^CorrectTable[Syndrome2(v1,v2)])

// get the number of error bits in this 24-bit code word
#define Errors(v)             Errors2(((v)>>12)&0xfff,(v)&0xfff)

// get the 12-bit corrected code from a 24-bit code word
#define Decode(v)             Decode2(((v)>>12)&0xfff,(v)&0xfff)

// Parity Check matrix
uint16_t H_P[12] = {
    0xa4f, 0xf68, 0x7b4, 0x3da,
    0x1ed, 0xab9, 0xf13, 0xdc6,
    0x6e3, 0x93e, 0x49f, 0xc75
};

/* Binary representation
  1 0 1 0   0 1 0 0   1 1 1 1
  1 1 1 1   0 1 1 0   1 0 0 0
  0 1 1 1   1 0 1 1   0 1 0 0
  0 0 1 1   1 1 0 1   1 0 1 0

  0 0 0 1   1 1 1 0   1 1 0 1
  1 0 1 0   1 0 1 1   1 0 0 1
  1 1 1 1   0 0 0 1   0 0 1 1
  1 1 0 1   1 1 0 0   0 1 1 0

  0 1 1 0   1 1 1 0   0 0 1 1
  1 0 0 1   0 0 1 1   1 1 1 0
  0 1 0 0   1 0 0 1   1 1 1 1
  1 1 0 0   0 1 1 1   0 1 0 1
*/

// calculate the number of 1s in a 24-bit word
uint8_t OnesInCode( uint32_t code, uint32_t size )
{
    uint8_t ret = 0;
    for( uint32_t i=0; i<size; i++ ) {
        if( (code>>i) & 1 )
            ret++;
    }
    return ret;
}

void InitGolayDecode( void )
{
    for( uint32_t x=0; x < GOLAY_SIZE; x++ ) {
        // generate syndrome LUT

```

```

SyndromeTable[x]=0;          // Default value of the Syndrome LUT
for( uint32_t i=0; i<12; i++ ) {
    if( (x>>(11-i)) & 1 ) SyndromeTable[x] ^= H_P[i];
    ErrorTable[x] = 4;
    CorrectTable[x]=0xffff;
}
}

// no error case
ErrorTable[0] = 0;
CorrectTable[0]= 0;
// generate all error codes up to 3 ones
for( int i=0; i<24; i++ ) {
    for( int j=0; j<24; j++ ) {
        for( int k=0; k<24; k++ ) {
            uint32_t error = (1<<i) | (1<<j) | (1<<k);
            uint32_t syndrome = Syndrome(error);
            CorrectTable[syndrome] = (error>>12) & 0xffff;
            ErrorTable[syndrome] = OnesInCode(error,24);
        }
    }
}
}
}

```

#### A.4. Decoding the Golay Code (8,1,3)

The one-byte 0x00 or 0xff can also be considered as a binary Golay code (8,1,3). It allows correcting the 0x00 or 0xff transmission of up to 3-bit errors, and detecting 4-bit errors. The (8,1,3) code decoding lookup tables shall be initialized by the InitGolay00FFDecode() function, and the decoding can be done by the Decode00FF(v) macro of the following C code.

```

#define BYTE_LUT_SIZE          0x100

uint8_t Decode00FFTable[ BYTE_LUT_SIZE ]; // decode 0x00 or 0xff (8,1,3)
uint8_t Error00FFTable[ BYTE_LUT_SIZE ]; // number of error bits (8,1,3)

#define Decode00FF(v)          Decode00FFTable[v]
#define Error00FF(v)           Error00FFTable[v]

void InitGolay00FFDecode ( void )
{
    // generate (8,1,3) tables
    for( uint32_t i=0; i<BYTE_LUT_SIZE; i++ ) {
        uint32_t j = OnesInCode(i,8);
        Decode00FFTable[i] = j <= 4 ? 0 : 0xff;
        Error00FFTable[i] = j <= 4 ? j : 8-j;
    }
}

```

## APPENDIX 7-B

### **Citations**

Golay, Marcel J. E. “Notes on Digital Coding” in *Proceedings of the IRE*, 1949, v.37, p. 657.

**\*\*\* END OF CHAPTER 7 \*\*\***

## CHAPTER 8

### Digital Data Bus Acquisition Formatting Standard

<b>Acronyms</b> .....		<b>8-iii</b>
<b>Chapter 8. Digital Data Bus Acquisition Formatting Standard</b> .....		<b>8-1</b>
<b>8.1 General</b> .....		<b>8-1</b>
<b>8.2 Word Structure</b> .....		<b>8-1</b>
8.2.1 Field Definition .....		8-1
8.2.2 Most Significant Bit.....		8-2
8.2.3 Bus/Group Identification Label .....		8-2
8.2.4 Content Identification Label .....		8-2
8.2.5 Information Content Field.....		8-2
8.2.6 Fill Words .....		8-3
8.2.7 Content Identification Label .....		8-3
8.2.8 Cyclic Redundancy Check.....		8-3
<b>8.3 Time Words</b> .....		<b>8-3</b>
<b>8.4 Composite Output</b> .....		<b>8-3</b>
8.4.1 Characteristics of a Singular Composite Output Signal .....		8-3
<b>8.5 Single Bus Track Spread Recording Format</b> .....		<b>8-5</b>
8.5.1 Single Bus Recording Technique Characteristics.....		8-5
<b>8.6 MIL-STD-1553</b> .....		<b>8-6</b>
8.6.1 Definitions.....		8-7
8.6.2 Source Signal .....		8-7
8.6.3 Word Structure.....		8-8
8.6.4 Time Words .....		8-9
<b>8.7 ARINC 429</b> .....		<b>8-9</b>
8.7.1 Definitions.....		8-10
8.7.2 Source Signal .....		8-10
8.7.3 Word Structure.....		8-10
8.7.4 Time Words .....		8-12

#### List of Figures

Figure 8-1.	Composite Frame Structure .....	8-4
Figure 8-2.	Multiple Tape Track Spread Format (4-Track Spread Example) .....	8-6
Figure 8-3.	System Block Diagram .....	8-7

#### List of Tables

Table 8-1.	Word Construction.....	8-1
------------	------------------------	-----

Table 8-2.	MIL-STD-1553 Formatted Word Construction.....	8-8
Table 8-3.	ARINC 429 Formatted Word Construction.....	8-11
Table 8-4.	ARINC Bit to Formatted Word Bit Mapping .....	8-12



## Acronyms

ARINC	Aeronautical Radio, Incorporated
CRC	cyclic redundancy check
FCS	frame check sequence
HDDR	high-density digital recording
MIL-STD	Military Standard
msb	most significant bit
PCM	pulse code modulation
RNRZ-1	randomized non-return-to-zero-level

This page intentionally left blank.

## CHAPTER 8

### Digital Data Bus Acquisition Formatting Standard

#### 8.1 General

This standard describes output data formats for the acquisition of all the traffic flowing on various digital data buses. The formats permit the capture of data from multiple data buses within a single system. Other constraints, such as radio frequency bandwidth and tape recording time, will dictate the actual number of buses processed by a single system. Standards for both composite telemetry pulse code modulation (PCM) and tape recorder PCM formats are presented.

Although specifically designed to satisfy the requirements of 100 percent Military Standard (MIL-STD) 1553 bus and Aeronautical Radio, Incorporated (ARINC) 429 channel acquisition, the formatting provisions of this standard may be used in other applications when the data source and content are similar enough to permit easy adaptation. Users should contact the appropriate range to ensure any adaptations are compatible with that range.

In addition to the total data capture technique and format presented in this chapter, “Selected Measurement” methods are available to acquire less than 100 percent of bus data. Selected Measurement methods result in PCM formats conforming to [Chapter 4](#) and fall outside the scope of this chapter.

This chapter presents the general requirements for data formatting followed by individual sections addressing specifics pertaining to MIL-STD-1553 and ARINC 429 respectively.

#### 8.2 Word Structure

The following subparagraphs describe the general word structure to be used for the formatted output. Specific word structures and definitions are provided as part of each bus/channel subsection.

##### 8.2.1 Field Definition

The formatted data shall be a 24-bit word constructed as shown in [Table 8-1](#).

Table 8-1. Word Construction																											
Bit Position																											
1	2	3	4	5	6	7	8	9	10	11	12	•	•	•	21	22	23	24									
P	A	R	I	T	Y	Or	Bus	Ident	Label	Content	Ident	Label	I	N	F	O	R	M	A	T	I	O	N	C	o	n	t
										A. Field Definition																	

Bit				Bit				
1	2	3	4	1	2	3	4	
0	0	0	0	1	0	0	0	Bus /Group 9
0	0	0	1	1	0	0	1	Bus /Group 10
0	0	1	0	1	0	1	0	Bus /Group 11
0	0	1	1	1	0	1	1	Bus /Group 12
0	1	0	0	1	1	0	0	Bus /Group 13
0	1	0	1	1	1	0	1	Bus /Group 14
0	1	1	0	1	1	1	0	Bus /Group 15
0	1	1	1	1	1	1	1	Bus /Group 16
B. Bus/Group Identification Label Definition; Bits (1) 2, 3, & 4								
Bit				Bit				
5	6	7	8	5	6	7	8	
1	1	1	1	0	1	1	1	Time - High Order
1	1	1	0	0	1	1	0	Time - Low Order
1	1	0	1	0	1	0	1	Time - Microsecond
1	1	0	0	0	1	0	0	Application Specific
1	0	1	1	0	0	1	1	User Defined
1	0	1	0	0	0	1	0	User Defined
1	0	0	1	0	0	0	1	Fill Word
1	0	0	0	0	0	0	0	Buffer Overflow
C. Content Identification Label Definition; Bits 5, 6, 7, & 8								

8.2.2 Most Significant Bit

The most significant bit (msb) (bit 1) of each formatted word may optionally be an odd parity bit generated for the resulting formatted word or an additional bit appended to the bus/group identification label as described in Paragraph [8.2.3](#).

8.2.3 Bus/Group Identification Label

Each word shall also carry a bus or group identification label as shown in [Table 8-1](#). For this application, a bus refers to a MIL-STD-1553 bus (or dual redundant bus pair) and a group refers to a collection of up to four ARINC 429 channels. The bus/group identification label may optionally be three or four bits in length dependent on the exercise of the option to use or not use a parity bit. If not used, the parity bit, or bit 1, is appended to the bus/group identification label to increase the bus count from a maximum of eight (3 bits) to a maximum of 16 (4 bits).

8.2.4 Content Identification Label

Each incoming bus word, auxiliary/user input, or time word shall be appropriately labeled with a 4-bit content identification label (see [Table 8-1](#)). Content identification labels are specific to each bus type and are detailed in later sections.

8.2.5 Information Content Field

Data extracted from the data bus shall maintain bit order integrity and be inserted into the information content field as specified for each bus type. Transposing or reordering of the bits is not permitted.

### 8.2.6 Fill Words

Fill words, required to maintain continuous PCM output, shall have the following sequence as the information content pattern:

1010 1010 1010 1010 (AAAA hexadecimal)

### 8.2.7 Content Identification Label

The content identification label indicating buffer overflow (0000) and appropriate bus/group identification label tag shall be appended to the first word placed into the buffer after the buffer becomes available for data storage. This word should be an extra word, not the next available piece of data. Bits 9 through 24 are available for system level diagnostics and are not specified here. Tagging in this manner marks the point of data discontinuity and preserves the integrity of the next piece of data.

### 8.2.8 Cyclic Redundancy Check

Cyclic redundancy check (CRC) is a very powerful technique for obtaining data quality. An optional CRC word may be appended as the last positional word of each PCM frame (see [Figure 8-2](#)). The CRC word shall be composed of parity and/or bus/group identification label, content identification label, and 16 bits of a frame check sequence (FCS). The FCS shall fill the information content field (bits 9 - 24). The following CRC-16 polynomial shall be used to generate the FCS. None of the 24 bits making up the entire CRC word shall be used in the calculation of the 16-bit FCS.

CRC-16 polynomial:  $X^{16} + X^{15} + X^2 + 1$

 <p><b>NOTE</b></p>	<p>Exercise care when assigning bus identification and content identification label codes to the CRC word. Although a positional word in the frame, legacy-processing algorithms may falsely identify the information if one of the bus data labels (1111 - 1000) is used as the content identification label.</p>
--	--

## 8.3 **Time Words**

The following describes the structure and use of time words within the formatted output.

The time words dedicated to providing timing information are defined in [Chapter 4](#). These time words are designated as high order time, low order time, and microsecond time. The MIL-STD-1553 bus data acquisition applications use an optional fourth time word, designated as response time. The response time word has the same structure as the microsecond time word. Time word structure shall follow the 16-bit per-word format shown in [Chapter 4](#), Figure 4-4, and be placed into the information content field (bits 9 through 24) in bit order.

## 8.4 **Composite Output**

### 8.4.1 Characteristics of a Singular Composite Output Signal

The following subparagraphs describe the characteristics for a singular composite output signal.

- a. The composite, continuous output shall conform to the requirements for Class 2 PCM as stated in [Chapter 4](#).

- b. The data shall be transmitted msb (bit 1) first.
- c. The bit rate is dependent on several factors including bus loading and auxiliary inputs and shall be set to a fixed rate sufficient to preclude any loss of data.
- d. The order of bus words must remain unaltered except in the case of a buffer overflow.
- e. The frame length shall be fixed using fill words as required and shall be > 128 words and < 512 words including the frame synchronization word.
- f. The frame synchronization word shall be fixed and 24 consecutive bits in length. The pattern, also shown in [Chapter 4](#) Appendix 4-A, Table A-1, is:

1111 1010 1111 0011 0010 0000 (FAF320 hexadecimal).

- g. A frame structure employing frame time is recommended but optional. If frame time is used, the frame structure shall consist of the frame synchronization word, followed by the high order time word, followed by the low order time word, followed by the microsecond time word, followed by the data words from all sources making up the composite signal up to the frame length specified in item [e](#) above (also see [Figure 8-1](#)). If frame time is not used, the frame synchronization word shall be followed immediately by the data words. If a CRC word is not used, the last word in the frame is data word N.

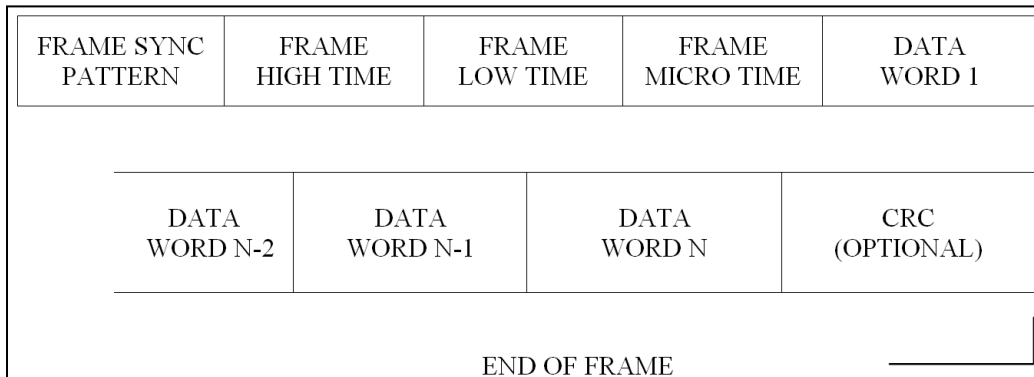



Figure 8-1. Composite Frame Structure

- h. The following describes the recommended techniques for recording the composite output signal.
  - (1) Longitudinal recording shall conform to the PCM recording provisions [Annex A-2](#).
  - (2) Recording using parallel high-density digital recording (HDDR) or rotary head recorders offers the advantage of inputting a single high bit rate signal to the recording system. The input PCM signal shall conform to the appropriate sections of this standard.
  - (3) If recording using digital recorders or other non-continuous recording processes with buffered inputs, the fill words, inserted to provide a continuous output stream, may be eliminated.

 <p><b>NOTE</b></p>	<p>Additional care must be exercised in data processing and reduction if the last word in a composite stream is a MIL-STD-1553 command word. The associated message time tag will not appear until <u>after</u> the synchronization and time words in the next frame.</p>
--	---

## 8.5 Single Bus Track Spread Recording Format

### 8.5.1 Single Bus Recording Technique Characteristics

The following subparagraphs describe the characteristics of a single bus recording technique using a multiple tape track spread output format.

- a. The target tape recorder/reproducer for a track spread format is a longitudinal fixed-head machine described in [Annex A-2](#) and not one employing parallel HDDR or rotary head recording characteristics.
- b. The code generated for longitudinal tape recording shall be randomized non-return-to-zero-level (RNRZ-L) or bi-phase-level as described in [Chapter 4](#) and [Annex A-2](#).

 <p><b>NOTE</b></p>	<p>Bit rates less than 200,000 bits per second are not recommended when using RNRZ-L.</p>
--	---

- c. To extend recording time while still acquiring 100 percent of bus data, a multiple track spread recording technique is presented as follows.
  - (1) When necessary to use more than one tape recording track (to extend record time), separate PCM streams shall be created and delayed by 24/TK bits with respect to each other, where TK represents the number of tape tracks used for a given bus.
  - (2) When multiple track-spread recording is required, the track spread shall be on a bus basis such as bus number 1 spread over four tracks, and bus number 2 spread over two tracks. The maximum number of tracks per bus shall be limited to four.

 <p><b>NOTE</b></p>	<p>Consideration should be given to spread track assignment. All tracks associated with a given bus should be recorded on the same head stack.</p>
--	--

- (3) Each stream shall have a frame synchronization pattern 24 bits in length, conforming to item [f](#) of Subsection [8.4.1](#).
- (4) The word structure shall be identical to that described in Paragraph [8.2](#).
- (5) The frame length shall be fixed and shall be the same for each track used for a given bus. The frame length shall conform to the requirements of item [e](#) in Subsection [8.4.1](#).
- (6) The data shall be formatted such that it is transmitted (recorded) msb (bit 1) first.
- (7) The use of a CRC word as described in Subparagraph [8.2.8](#) is optional. If used in the track spread application, a CRC word must be generated and appended to each of the PCM frames for that bus.

- (8) A structure employing frame time is recommended but optional. The following describes a four-track spread example using frame time.
- TK1. The PCM stream designated TK1 shall be constructed as the frame synchronization word, followed by the high order frame time word, followed by data words (see [Figure 8-2](#)).

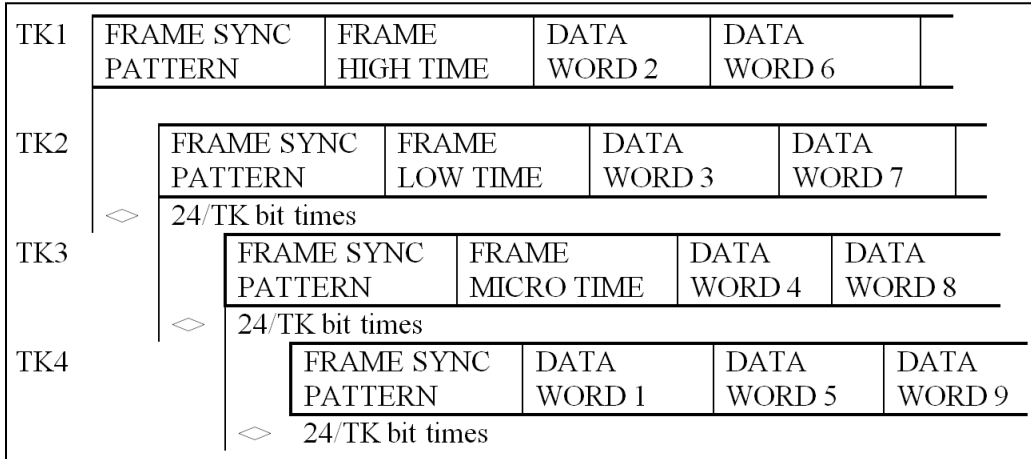



Figure 8-2. Multiple Tape Track Spread Format (4-Track Spread Example)

- TK2. The PCM stream designated TK2 shall be constructed as the frame synchronization word, followed by the low order frame time word, followed by data words.
- TK3. The PCM stream designated TK3 shall be constructed as the frame synchronization word, followed by the microsecond frame time word, followed by data words.
- TK4. The PCM stream designated TK4 shall be constructed as the frame synchronization word, followed by the first data word, followed by other data words.

 <p><b>NOTE</b></p>	<p>Schemes using one, two, or three tracks for a given bus shall follow like construction; that is, sequencing through the data track by track. If frame time is not used, data words shall immediately follow the frame synchronization patterns.</p>
--	--

 <p><b>NOTE</b></p>	<p>Additional care must be exercised in data processing and reduction if the last word in the final track spread stream is a MIL-STD-1553 command word. The associated message time tag will not appear until after the synchronization and time words in the next frame.</p>
--	---

## 8.6 MIL-STD-1553

The following subsections describe specific formatting requirements for the 100 percent acquisition of MIL-STD-1553 bus information.



8.6.1 Definitions

- a. Bus Monitor. The terminal assigned the task of receiving bus traffic and extracting all information to be used at a later time.
- b. Data Bus. All hardware including twisted shielded pair cables, isolation resistors, and transformers required to provide a single data path between the bus controller and all associated remote terminals.
- c. Dual Redundant Data Bus. The use of two data buses to provide multiple paths between the subsystems.
- d. Bus Loading. The percentage of time the data bus is active.
- e. Maximum Burst Length. The maximum length of a continuous burst of messages with minimum length message gaps.
- f. Bus Error. A condition that violates the definition of MIL-STD-1553 word structure. Conditions such as synchronization, Manchester, parity, non-contiguous data word, and bit count/word errors are all considered word type errors. System protocol errors such as incorrect word count/message and illegal mode codes are not considered bus errors.

8.6.2 Source Signal

The source of data is a signal conforming to MIL-STD-1553. Format provisions are made for a dual redundant data bus system. The interface device performing the data acquisition shall be configured as a bus monitor. [Figure 8-3](#) depicts in block diagram form the concept of 100 percent MIL-STD-1553 bus data acquisition.

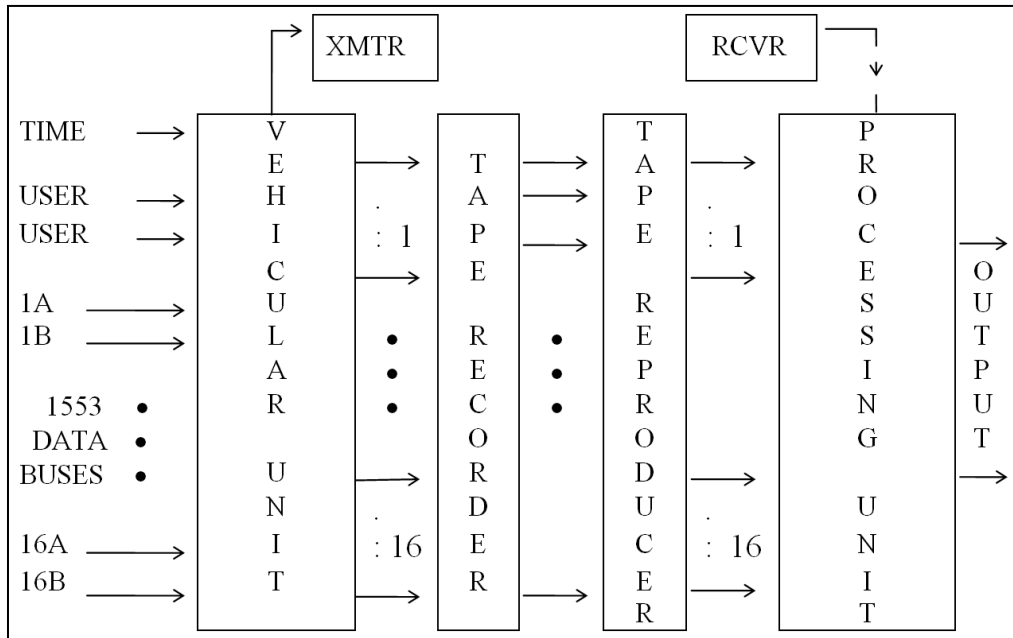
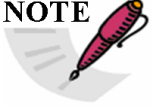

Figure 8-3. System Block Diagram

	<p><b>NOTE</b> In the design of the interface to the MIL-STD-1553 bus, it may be necessary to include buffers to prevent loss of data and to conserve bandwidth. The buffer size is influenced by bus loading, maximum burst length, output bit rate, tape recording speed, time tagging, and auxiliary inputs.</p>
---	---

8.6.3 Word Structure

The specific word structure provisions to be used for MIL-STD-1553 bus formatted output are described below.

- a. The formatted data shall be a 24-bit word constructed as shown in [Table 8-1](#) and [Table 8-2](#).
- b. The information extracted from the MIL-STD-1553 bus shall have the synchronization pattern and parity bit removed.
- c. Each incoming MIL-STD-1553 word (Command, Status, or Data), auxiliary input, or time word shall be appropriately labeled with a 4-bit Content Identification Label as described in [Table 8-1](#) and [Table 8-2](#).
- d. Data extracted from the MIL-STD-1553 bus shall maintain bit order integrity in the information field for a command, status, data, and error word. Bit position 4 in the MIL-STD-1553 bus word shall be placed into bit position 9 in the formatted data word. The remaining bits of the MIL-STD-1553 bus word shall be placed in successive bit positions in the formatted data word. Transposing or reordering of the bits is not permitted.
- e. For bus errors as defined in item [f](#) of Subsection [8.6.1](#) (Error A - 1100 or Error B - 1000), the synchronization pattern and the parity bit are removed as stated in item [b](#) above. The Information Content bits, 9 - 24, of the formatted word shall contain the resulting 16-bit pattern extracted from the bus.

<b>Table 8-2. MIL-STD-1553 Formatted Word Construction</b>																										
BIT POSITION																										
1	2	3	4	5	6	7	8	9	10	11	12	•	•	•	21	22	23	24								
P A R I T Y	BUS IDENT LABEL							CONTENT IDENT LABEL													I N F O R M A T I O N C O N T E N T					
		OR						BUS IDENT LABEL																		
a. Field Definition																										

BIT				BIT					
1	2	3	4	1	2	3	4		
0	0	0	0	BUS 1	1	0	0	0	BUS 9
0	0	0	1	BUS 2	1	0	0	1	BUS 10
0	0	1	0	BUS 3	1	0	1	0	BUS 11
0	0	1	1	BUS 4	1	0	1	1	BUS 12
0	1	0	0	BUS 5	1	1	0	0	BUS 13
0	1	0	1	BUS 6	1	1	0	1	BUS 14
0	1	1	0	BUS 7	1	1	1	0	BUS 15
0	1	1	1	BUS 8	1	1	1	1	BUS 16

**b. MIL-STD-1553 Bus/Group Identification Label Definition; Bits (1) 2, 3, & 4**

BIT				BIT					
5	6	7	8	5	6	7	8		
1	1	1	1	COMMAND A	0	1	1	1	TIME - HIGH ORDER
1	1	1	0	STATUS A	0	1	1	0	TIME - LOW ORDER
1	1	0	1	DATA A	0	1	0	1	TIME - MICROSECOND
1	1	0	0	ERROR A	0	1	0	0	TIME - RESPONSE
1	0	1	1	COMMAND B	0	0	1	1	USER DEFINED
1	0	1	0	STATUS B	0	0	1	0	USER DEFINED
1	0	0	1	DATA B	0	0	0	1	FILL WORD
1	0	0	0	ERROR B	0	0	0	0	BUFFER OVERFLOW

**NOTE:**  
A = primary channel of the dual redundant bus; B = secondary channel

**c. MIL-STD-1553 Content Identification Label Definition; Bits 5, 6, 7, & 8**

**8.6.4 Time Words**

**8.6.4.1 Time Tagging**

If time tagging of the occurrence of MIL-STD-1553 messages is necessary to satisfy user requirements, the first command word of the message shall be time tagged. The time words shall immediately follow the first command word in the following order: high order time, low order time, and microsecond time.

**8.6.4.2 Response Time Word**

The optional response time word shall have one-microsecond resolution and shall indicate the response time of the data bus. The response time word shall immediately precede the status word associated with it.

 <p><b>NOTE</b></p>	<p>If the response time function is not used, Content Identification Label 0100 may be assigned to user-defined inputs.</p>
--	---

**8.7 ARINC 429**

The following subsections describe specific formatting requirements for the 100 percent acquisition of ARINC 429 channel information.

### 8.7.1 Definitions

- a. Monitor. The receiver or sink assigned the task of receiving bus traffic and extracting all information to be used at a later time.
- b. Data Bus. All hardware including twisted shielded pair cables, required to provide a single data path between the transmitter or source and the associated receivers or sinks.
- c. Channel Error. Conditions detected which violate the definition of ARINC 429 word structure as specified in ARINC specification 429P1, 429P2, and 429P3. Conditions such as parity and bit count/word errors are all considered among word type errors. System protocol errors are not considered bus errors.

### 8.7.2 Source Signal

The source of data is a signal conforming to ARINC 429. Format provisions are made for up to 64 channels. The interface device performing the data acquisition shall be configured as a monitor. In principle, [Figure 8-3](#) depicts in block diagram form the concept of 100 percent bus data acquisition.

### 8.7.3 Word Structure

The following descriptions contain specific word structure provisions to be used for the ARINC 429 formatted output.

- a. The formatted data shall be a 24-bit word constructed as shown in [Table 8-1](#) and [Table 8-3](#).
- b. Each incoming ARINC 429 word, auxiliary input, or time word shall be appropriately labeled with a 4-bit Content Identification Label as described in [Table 8-1](#) and [Table 8-3](#).
- c. The format provides for addressing of up to 64 channels. Each Bus/Group Identification Label (designated GROUP X) may be associated with up to 4 independent ARINC 429 channels through the use of a High and Low Syllable technique described in item [d](#) below and shown in [Table 8-4](#).
- d. Data extracted from the ARINC 429 channel shall maintain bit order integrity in the Information Content field. Each ARINC 429 word is 32 bits in length. To accommodate this word length within the described format, each ARINC word is divided into two segments, each 16 bits in length. These segments will be referred to as ARINC High Syllable and ARINC Low Syllable. [Table 8-4](#) describes the mapping of the 32-bit ARINC 429 word into the Information Content bits (9 - 24) of the ARINC High and Low Syllable words. Transposing or reordering of the bits is not permitted.
- e. For channel errors defined in item [c](#) of Subsection [8.7.1](#), the following procedure shall be followed. An error word shall be generated using the appropriate bus/group identification label and 0100 as the content identification label. Bits 9-12 shall contain the content identification label code associated with the appropriate ARINC high syllable channel, bits 13 - 16 shall contain the content identification label for the ARINC low syllable associated with that channel, and bits 17 - 24 are available for system level diagnostics and are not specified here. The next occurrence of that bus/group identification label coupled with those ARINC high and low syllable content identification labels shall

contain the respective data extracted from the channel that was deemed to be in error. The information content bits, 9 - 24, of the formatted word shall contain the resulting 16-bit pattern syllables as extracted from the channel.

**Table 8-3. ARINC 429 Formatted Word Construction**

BIT POSITION																		
1	2	3	4	5	6	7	8	9	10	11	12	•	•	•	21	22	23	24
P A R I T Y	GROUP IDENT LABEL			CONTENT IDENT LABEL				INFORMATION CONTENT										
	OR																	
	GROUP IDENT LABEL																	
a. Field Definition																		
BIT 1 2 3 4								BIT 1 2 3 4										
0 0 0 0				GROUP 1				1 0 0 0				GROUP 9						
0 0 0 1				GROUP 2				1 0 0 1				GROUP 10						
0 0 1 0				GROUP 3				1 0 1 0				GROUP 11						
0 0 1 1				GROUP 4				1 0 1 1				GROUP 12						
0 1 0 0				GROUP 5				1 1 0 0				GROUP 13						
0 1 0 1				GROUP 6				1 1 0 1				GROUP 14						
0 1 1 0				GROUP 7				1 1 1 0				GROUP 15						
0 1 1 1				GROUP 8				1 1 1 1				GROUP 16						
b. ARINC 429 Bus/Group Identification Label Definition; Bits (1) 2, 3, & 4																		
BIT 5 6 7 8								BIT 5 6 7 8										
1 1 1 1				High Syllable #4				0 1 1 1				TIME - HIGH ORDER						
1 1 1 0				Low Syllable #4				0 1 1 0				TIME - LOW ORDER						
1 1 0 1				High Syllable #3				0 1 0 1				TIME - MICROSECOND						
1 1 0 0				Low Syllable #3				0 1 0 0				ERROR						
1 0 1 1				High Syllable #2				0 0 1 1				USER DEFINED						
1 0 1 0				Low Syllable #2				0 0 1 0				USER DEFINED						
1 0 0 1				High Syllable #1				0 0 0 1				FILL WORD						
1 0 0 0				Low Syllable #1				0 0 0 0				BUFFER OVERFLOW						
c. ARINC 429 Content Identification Label Definition; Bits 5, 6, 7, & 8																		

<b>Table 8-4. ARINC Bit to Formatted Word Bit Mapping</b>															
9	10	11	12	13	14	15	16	17	18	19	20	21	22	23	24
a. Information Content field bits															
32	31	30	29	28	27	26	25	24	23	22	21	20	19	18	17
b. ARINC High Syllable bit mapping															
16	15	14	13	12	11	10	9	8	7	6	5	4	3	2	1
c. ARINC Low Syllable bit mapping															

8.7.4 Time Words

If time tagging of the occurrence of ARINC 429 messages is necessary to satisfy user requirements, the time words shall immediately follow the ARINC Low Syllable word in the following order:

- a. High-order time;
- b. Low-order time;
- c. Microsecond time.

**\*\*\*\* END OF CHAPTER 8 \*\*\*\***

## CHAPTER 9

### Telemetry Attributes Transfer Standard

<b>Acronyms</b> .....		<b>9-v</b>
<b>Chapter 9.</b>	<b>Telemetry Attributes Transfer Standard</b> .....	<b>9-1</b>
<b>9.1</b>	<b>General</b> .....	<b>9-1</b>
<b>9.2</b>	<b>Scope</b> .....	<b>9-1</b>
<b>9.3</b>	<b>Purpose</b> .....	<b>9-1</b>
<b>9.4</b>	<b>Media and Data Structure</b> .....	<b>9-1</b>
9.4.1	Physical Format .....	9-2
9.4.2	Logical Format.....	9-2
9.4.3	Extensible Markup Language Format.....	9-3
<b>9.5</b>	<b>Telemetry Attributes</b> .....	<b>9-4</b>
9.5.1	Contents .....	9-5
9.5.2	General Information Attributes (G) .....	9-9
9.5.3	Transmission Attributes (T).....	9-14
9.5.4	Recorder-Reproducer Attributes (R).....	9-21
9.5.5	Multiplex/Modulation (Mux/Mod) Attributes (M).....	9-85
9.5.6	PCM Format Attributes (P).....	9-92
9.5.7	PCM Measurement Description Attributes (D) .....	9-112
9.5.8	Bus Data Attributes (B) .....	9-121
9.5.9	Message Data Attributes (S) .....	9-134
9.5.10	Message Structure Attributes (Q) .....	9-142
9.5.11	Data Conversion Attributes (C) .....	9-154
9.5.12	Airborne Hardware Attributes (H).....	9-169
9.5.13	Vendor-Specific Attributes (V).....	9-169
9.5.14	TMATS eXtension Attributes (X) .....	9-170
<b>9.6</b>	<b>Data Display Standard: Data Display Markup Language</b> .....	<b>9-170</b>
9.6.1	Data Display Markup Language Purpose and Objectives .....	9-171
9.6.2	Data Display Markup Language Layered Structure .....	9-171
9.6.3	Data Display Markup Language Global Element Glossary.....	9-172
<b>9.7</b>	<b>Instrumentation Hardware Abstraction Language</b> .....	<b>9-175</b>
9.7.1	Usage of External Schemas in IHAL.....	9-176
9.7.2	What is the Instrumentation Hardware Abstraction Language?.....	9-176
9.7.3	What is the IHAL API?.....	9-176
9.7.4	How Can IHAL Be Used? .....	9-177
9.7.5	IHAL Glossary .....	9-177
9.7.6	Complete IHAL API Specification.....	9-182
<b>Appendix 9-A.</b>	<b>Application of the Telemetry Attributes Transfer Standard</b> .....	<b>A-1</b>

**A.1. Data Entry System ..... A-2**

**A.2. Source Database ..... A-3**

**A.3. Export Program ..... A-3**

**A.4. Interchange Medium ..... A-3**

**A.5. Import Program ..... A-3**

**A.6. Destination Database ..... A-3**

**A.7. Telemetry Setup System ..... A-3**

**A.8. Telemetry Processing Equipment..... A-3**

**Appendix 9-B. Telemetry Attributes Transfer Standard Cover Sheet..... B-1**

**Appendix 9-C. Telemetry Attributes Transfer Standard Format Example ..... C-1**

**C.1. Introduction..... C-1**

**C.2. Overview of Example..... C-1**

**Appendix 9-D. Floating Point Formats..... D-1**

**D.1. Introduction..... D-1**

**D.2. IEEE 754 32-Bit Single Precision Floating Point ..... D-1**

**D.3. IEEE 754 64-Bit Double Precision Floating Point ..... D-1**

**D.4. MIL-STD-1750A 32-Bit Single Precision Floating Point ..... D-2**

**D.5. MIL-STD-1750A 48-Bit Double Precision Floating Point ..... D-2**

**D.6. DEC 32-Bit Single Precision Floating Point ..... D-2**

**D.7. DEC 64-Bit Double Precision Floating Point ..... D-2**

**D.8. DEC 64-Bit “G” Double Precision Floating Point ..... D-3**

**D.9. IBM 32-Bit Single Precision Floating Point..... D-3**

**D.10. IBM 64-Bit Double Precision Floating Point..... D-3**

**D.11. TI (Texas Instruments) 32-Bit Single Precision Floating Point..... D-3**

**D.12. TI (Texas Instruments) 40-Bit Extended Precision Floating Point ..... D-4**

**Appendix 9-E. Derived Parameter Specification..... E-1**

**E.1. Derived Parameter Definition..... E-1**

**E.2. Derived Algorithm Grammar: Components ..... E-1**

**E.3. Operators ..... E-1**

    E.3.a. Arithmetic Operators ..... E-2

    E.3.b. Bit Manipulation Operators ..... E-2

    E.3.c. Relational Operators ..... E-2

    E.3.d. Ternary (if then else) Operator ..... E-3

    E.3.e. Associativity Operator ..... E-3



E.3.f.	Precedence and Associativity of Operators From Highest to Lowest .....	E-3
<b>E.4.</b>	<b>Numeric Constants.....</b>	<b>E-3</b>
<b>E.5.</b>	<b>Measurements .....</b>	<b>E-4</b>
<b>E.6.</b>	<b>Mathematical Functions.....</b>	<b>E-4</b>
E.6.a.	Mathematical Function Format.....	E-4
E.6.b.	Complex Use of Functions.....	E-4
<b>E.7.</b>	<b>Derived Grammar Syntax Overview .....</b>	<b>E-5</b>
<b>E.8.</b>	<b>Grammar Examples.....</b>	<b>E-6</b>
<b>E.9.</b>	<b>Telemetry Attributes Transfer Standard (TMATS) Examples.....</b>	<b>E-10</b>
E.9.a.	TMATS Example 1.....	E-11
E.9.b.	TMATS Example 2.....	E-11
E.9.c.	TMATS Example 3.....	E-12
E.9.d.	TMATS Example 4.....	E-12
<b>E.10.</b>	<b>Glossary of Terms.....</b>	<b>E-14</b>
<b>Appendix 9-F.</b>	<b>Citations.....</b>	<b>F-1</b>

### List of Figures

Figure 9-1.	Group Relationships.....	9-8
Figure 9-2.	General Information Group (G).....	9-9
Figure 9-3.	Transmission Attributes Group (T).....	9-14
Figure 9-4.	Recorder-Reproducer Attributes Group (R) .....	9-21
Figure 9-5.	Multiplex/Modulation Attributes Group (M).....	9-85
Figure 9-6.	PCM Format Attributes Group (P) .....	9-92
Figure 9-7.	PCM Measurement Description Attributes Group (D).....	9-112
Figure 9-8.	Bus Data Attributes Group (B) .....	9-121
Figure 9-9.	Message Data Attributes Group (S).....	9-134
Figure 9-10.	Message Structure Attributes Group (Q) .....	9-142
Figure 9-11.	Data Conversion Attributes Group (C).....	9-154
Figure 9-12.	Layered Structure of DDML.....	9-171
Figure A-1.	Typical Elements of the Telemetry Attributes Transfer Process .....	A-2
Figure B-1.	Sample Cover Sheet for Attribute Transfer Files .....	B-1
Figure C-1.	Group Linkages.....	C-2
Figure E-1.	Grammar Syntax .....	E-6
Figure E-2.	Yacc Grammar Example, Page 1 of 2.....	E-7
Figure E-3.	Yacc Grammar Example, Page 2 of 2.....	E-8
Figure E-4.	Lex Grammar Example, Page 1 of 2.....	E-9
Figure E-5.	Lex Grammar, Page 2 of 2.....	E-10
Figure E-6.	Example Program (Main) .....	E-10

### List of Tables

Table 9-1.	Telemetry Attribute Groups.....	9-5
------------	---------------------------------	-----

Table 9-2.	General Information Group (G) .....	9-10
Table 9-3.	Transmission Attributes Group (T).....	9-16
Table 9-4.	Recorder-Reproducer Attributes Group (R) .....	9-30
Table 9-5.	Multiplex/Modulation Group (M).....	9-87
Table 9-6.	PCM Format Attributes Group (P) .....	9-95
Table 9-7.	PCM Measurement Description Group (D).....	9-114
Table 9-8.	Bus Data Attributes Group (B) .....	9-123
Table 9-9.	Message Data Attributes Group (S).....	9-136
Table 9-10.	Message Structure Attributes Group (Q) .....	9-145
Table 9-11.	Data Conversion Attributes Group (C).....	9-157
Table 9-12.	Data Display Markup Language Global Element Glossary.....	9-172
Table 9-13.	IHAL External Schemas .....	9-176
Table 9-14.	Retrieve a Vendor’s Pool .....	9-182
Table 9-15.	Retrieve the List of Available Configurations .....	9-183
Table 9-16.	Retrieve a Specific Configuration.....	9-183
Table 9-17.	Change the Value of a Configurable Attribute .....	9-183
Table 9-18.	Create a New Configuration .....	9-184
Table 9-19.	Add a Device to a Configuration .....	9-184
Table 9-20.	Remove a Device from a Configuration .....	9-184
Table 9-21.	“Program” the Hardware.....	9-184
Table 9-22.	Add a New Format to a Data Encoder .....	9-185
Table 9-23.	Add a Measurement to an Existing Format .....	9-185
Table 9-24.	Remove a Measurement From a Format.....	9-186
Table C-1.	PCM Format for PCM w/ASync .....	C-4
Table C-2.	PCM Format for PCM1 .....	C-5
Table C-3.	PCM Format for ASync .....	C-6
Table D-1.	Floating Point Formats.....	D-1
Table E-1.	Arithmetic Operators .....	E-2
Table E-2.	Bit Manipulation Operators .....	E-2
Table E-3.	Relational Operators .....	E-2
Table E-4.	Ternary (if then else) Operator .....	E-3
Table E-5.	Associativity Operator .....	E-3
Table E-6.	Precedence and Associativity of Operators from Highest to Lowest .....	E-3
Table E-7.	Numeric Constants (Examples) .....	E-3
Table E-8.	Measurements (Examples).....	E-4
Table E-9.	Table of Selected Mathematical Functions.....	E-5

## Acronyms

API	application programming interface
ARINC	Aeronautical Radio, Incorporated
ASCII	American Standard Code for Information Interchange
CR	carriage return
dB	decibel
DDML	Data Display Markup Language
FFI	frame format identification
FM	frequency modulation
HTML	hypertext markup language
Hz	hertz
IAW	in accordance with
IHAL	Instrumentation Hardware Abstraction Language
iNET	integrated Network Enhanced Telemetry
kHz	kilohertz
LF	line feed
lsb	least significant bit
MDL	Metadata Description Language
MHz	megahertz
MIL-STD	Military Standard
msb	most significant bit
ODBC	open database connectivity
PCM	pulse code modulation
PM	phase modulation
RF	radio frequency
SST	serial streaming telemetry
SVG	Scalable Vector Graphics
TMATS	Telemetry Attributes Transfer Standard
TmNS	Telemetry Network Standard
W3C	World Wide Web Consortium
XidML	eXtensible Instrumentation Definition Markup Language
XML	eXtensible Markup Language
XSD	XML schema document

This page intentionally left blank.

## CHAPTER 9

### Telemetry Attributes Transfer Standard

#### 9.1 General

Telemetry attributes are those parameters required by the receiving/processing system to acquire, process, and display the telemetry data received from the test item/source. The telemetry attributes defined in this chapter provide the information required to set up the telemetry receiving and processing equipment. The format, while not necessarily compatible with any receiving/processing system, will allow test ranges or other receiving systems to develop a computer conversion program to extract the information and to set up data required for their unique equipment configuration.

The intent of this chapter is to cover, primarily, attributes and terminology included in or consistent with the other chapters within this telemetry standards document. For example, pulse code modulation (PCM) format attributes should comply with the PCM standards as given in [Chapter 4](#). Other attributes are sometimes included for service and utility, but should not be construed as endorsements apart from the other chapters.

#### 9.2 Scope

The Telemetry Attributes Transfer Standard (TMATS) provides the definition of the telemetry attributes and specifies the media and data format necessary to permit the transfer of the information required to set up the telemetry receiving/processing functions at a test range. The standard does not conform to, nor does it define, existing or planned capabilities of any given test range. The parameters included in this document are defined by specific reference. Other nonstandard parameter values/ definitions may be included in the comments section of each group.

#### 9.3 Purpose

The TMATS provides a common format for the transfer of information between the user and a test range or between ranges (see [Appendix 9-A](#)). This format will minimize the “station-unique” activities that are necessary to support any test item. In addition, TMATS is intended to relieve the labor-intensive process required to reformat the information by providing the information on computer-compatible media, thereby reducing errors and requiring less preparation time for test support.

#### 9.4 Media and Data Structure

A variety of physical and electronic media is available for use in exchanging attribute information. The most important factor in selecting a medium is that the parties involved agree to use that specific medium. If any data compression (such as backup/restore or zip/unzip) will be used, both parties should agree to its use.

A cover sheet describing the system that produced the attribute medium should accompany the attribute information. A recommended format for the cover sheet is given in [Appendix 9-B](#).

#### 9.4.1 Physical Format

Attributes for each mission configuration are to be supplied in a single physical file with contents as 7-bit American Standard Code for Information Interchange (ASCII) coded characters. Line feed (LF) and carriage return (CR) may be used to improve readability of the information. Nonprintable characters will be discarded by the destination agency prior to translating the attributes into telemetry system configuration information.

Multiple mission configurations may be provided on a single disk; however, each configuration must be in a separate file identified in the disk directory. File names should use the file extensions “.TXT” to indicate a text file or “.TMT” or “.TMA” to indicate a TMATS file. A stick-on label and the accompanying cover sheet identify the file names corresponding to the mission configuration used for each mission.

#### 9.4.2 Logical Format

Each attribute appears in the file as a unique code name and as a data item. The code name appears first, delimited by a colon. The data item follows, delimited by a semicolon. Thus, an attribute is formatted as A:B; - where A is the code name and B is the data item, in accordance with (IAW) the tables in Section 9.5. Numeric values for data items may be either integer or decimal. Scientific notation (see note below) is allowed only for the specific data items defined for its use in the tables in Section 9.5. For alphanumeric data items, including keywords, either upper or lower case is allowed; TMATS is not case sensitive. All defined keyword values are shown as upper case and enclosed in quotes in the tables in Section 9.5. Leading, trailing, and embedded blanks are assumed to be intentional; they can be ignored in most cases but should not be used in code names, keywords, and data items used as links, such as measurement name. Semicolons are not allowed in any data item (including comment items). Any number of attributes may be supplied within a physical record. Attributes may appear in any order.

 <p><b>NOTE</b></p>	<p>Any numeric data item expressed in scientific notation must conform to the following regular expression:</p> $([+-]?(\d+(\.\d+)?) (\d+\.\d+))([eE][+-]?\d+\{1,3\})$ <p>This expression limits the number of digits in the exponent to three or less, but allows any number of digits (including none) both before and after the decimal point in the fraction. Also, the decimal point can be omitted (for example, “3E5” is valid).</p>
--	---

The two basic types of attribute code names are single-entry and multiple-entry. Single-entry attributes are those for which there is only one data item. Multiple-entry attributes appear once in the definition tables in Section 9.5 but have multiple items; these items are assigned a number. The number appears in the code name preceded by a hyphen. For example, data source identifiers might have the following entries:

G\DSI-1:Aircraft;

G\DSI-2:Missile;

G\DSI-3:Target;

The code name COMMENT may be used to interject comments to improve readability. The comment data items, such as G\COM, are intended to convey further details within the TMATS file itself. Comments must follow the attribute logical format, as shown below:

COMMENT: This is an example of a comment;

Refer to Section [9.5](#) for detailed definitions of code names and attributes and [Appendix 9-C](#) for an example application of this standard.

<p><b>NOTE</b></p> 	<p>It is recommended that data source/link names and measurement names consist of only the following:</p> <ul style="list-style-type: none"> <li>• Capitalized alphabetic characters</li> <li>• Numeric characters</li> <li>• The underscore symbol (“_”)</li> </ul> <p>Specifically, it is recommended to avoid the use of embedded spaces and other special characters in data source/link names and measurement names.</p>
--	---

#### 9.4.3 Extensible Markup Language Format

In addition to the code name format described in Subsection [9.4.2](#), TMATS attributes can also be expressed in extensible markup language (XML). The TMATS XML format is implemented as a standard XML schema consisting of a collection of XML schema document (XSD) files, which can be found [here](#). Additionally, a graphical depiction of the schema in HTML format is available [here](#). The HTML files are very large and will take time to download.

The TMATS XML schema is identical in content to the telemetry attributes described in Section [9.5](#) below, with the exceptions shown in the following list.

- a. There is a C group for each data link instead of only one C group in the TMATS file.
- b. The schema has no counter (“\N”) attributes; they are not needed in XML.
- c. Keyword attribute values are expanded for readability in the schema.
- d. Date and time formats are different; the schema uses the XML standard date and time formats (not the ones in Section [9.5](#)).
- e. Text entries in the XML schema may contain semicolons; the code name format uses the semicolon as a delimiter.
- f. The inherent structure of an XML schema implies order, while the code name format allows the attributes to be given in any order.

In addition to the TMATS XML schema, there are two other XML schemas that describe related areas of information. The first one, Data Display Markup Language (DDML), covers commonly used types of data displays. Refer to Section [9.6](#) for a full description of this standard format for data display definitions. The other one, Instrumentation Hardware Abstraction Language (IHAL), deals with the instrumentation hardware configuration on a test item. See Section [9.7](#) for a full description of this standard format for describing instrumentation hardware.

## 9.5 Telemetry Attributes

The description of the mission configuration includes all potential sources of data; these sources are radio frequency (RF) links, pre- or post-detected tapes, and onboard recorded tapes and storage media. Each of these data sources has unique characteristics that must be defined. Each source is given a unique identity and its characteristics are specifically defined in associated attribute fields. In multiplexed systems, each data stream is uniquely identified by a data link name, which is related to the data source name.

 <p><b>NOTE</b></p>	<p>Only the information that is essential to define the attributes of a system is required. Non-applicable information does not need to be included in the file; however, all attribute information given is to be provided in the specified format.</p>
--	--

The attributes defined in this section proceed from the general level to the detailed level. The groups, defined in terms of data to be entered, are:

- a. General Information: Establishes the top-level program definition and identifies the data sources.
- b. Transmission Attributes: Defines an RF link. There will be one group for each RF link identified in the General Information group.
- c. Recorder-Reproducer Attributes: Identifies a tape or storage data source.
- d. Multiplex/Modulation Attributes: Describes the FM/FM (frequency modulation), FM/PM (phase modulation), or PM/PM multiplex characteristics. Each multiplexed waveform must have a unique set of attributes. For the analog measurement, the tie to the engineering units conversion is made in this group.
- e. Digital Data Attributes: Divided into four groups: the PCM Format Attributes, the PCM Measurement Description, the Bus Data Attributes, and the Message Data Attributes.
  - (1) PCM Format Attributes: Defines the PCM data format characteristics, including embedded formats. Each PCM format will have a separate format attributes group.
  - (2) PCM Measurement Descriptions: Defines each PCM measurement within the overall PCM format.
  - (3) Bus Data Attributes: Specifies the PCM-encoded Military Standard (MIL-STD) 1553 or Aeronautical Radio, Incorporated (ARINC) 429 bus format characteristics or the direct recorder track/channel MIL-STD-1553 or ARINC 429 bus format characteristics.
  - (4) Message Data Attributes: Specifies the message-based data streams.
- f. Pulse Amplitude Modulation Attributes: As of RCC IRIG 106-13, this section has been removed. See [Annex A.1](#) for applicable Pulse Amplitude Modulation data standards.
- g. Data Conversion Attributes: Contains the data conversion information for all measurements in this telemetry system. The calibration data and conversion definition of raw telemetry data to engineering units is included. The tie to the measurands of the telemetry systems defined in the previous groups is via the measurement name.



- h. Airborne Hardware Attributes: Defines the configuration of airborne instrumentation hardware in use on the test item.
- i. Vendor-Specific Attributes: Provides information that is specific to a vendor.

9.5.1 Contents

The following subparagraphs discuss the organization of the attributes and their relationships with the various groups.

- a. Organization. Attribute information is organized according to a hierarchical structure in which related items are grouped and given a common heading. The number of levels varies within the overall structure and is a function of the logical association of the attributes. At the highest level, the telemetry attributes are defined for the groups displayed in [Table 9-1](#).



<b>Identifier</b>	<b>Title</b>
G	General Information
T	Transmission Attributes
R	Recorder-Reproducer Attributes
M	Multiplex/Modulation Attributes
P	PCM Format Attributes
D	PCM Measurement Description
B	Bus Data Attributes
S	Message Data Attributes
Q	Message Structure Definition Attributes
C	Data Conversion Attributes
H	Airborne Hardware Attributes
V	Vendor-Specific Attributes
X	TMATS eXtension Attributes

Within the structure, a lower-case letter, for example, n, p, or r, indicates a multiple-entry item with the index being the lower-case letter. The range of these counters is from one to the number indicated in another data entry, usually with the appendage \N, and have no missing values.

The Usage Attributes column within each table describes how a particular attribute is to be used, when it is allowed, etc. If there are enumerations for the attribute, the enumeration values and their descriptions will appear in this column. There are 7 possible fields within this column for each attribute.

- **R/R Ch 10 Status**: This describes special rules for creating TMATS files to support setup of a Chapter 10 recorder. A value of “R” requires that the attribute be specified in the TMATS file whenever the attribute is allowed. A value of “RO” indicates that when an applicable data type or group is used, the attribute must be specified in the TMATS file. A value of “RO-PAK” indicates the attribute must be specified when the Data Packing Option (R-x\PDP-n) is either UNPACKED (UN) or PACKED

(PFS). If the attribute is specified in the TMATS file, it must contain valid information.

- Allowed when: This describes when an attribute is allowed to be specified inside of a TMATS file.
- Required when: This describes when an attribute must be specified inside of a TMATS file. If the Required condition is “When Allowed”, then it must be specified when the “Allowed when” condition is met.
- Links to: Specifies a list of attributes that the attribute links to by value.
- Links from: Specifies a list of attributes that link to this attribute by value. Any attribute with a Links from: is a key and must be unique in the TMATS file.
- Range: This describes the values or ranges that may be specified. A range might be specified with exact values or may reference the value of another TMATS attribute. The range may also be simply a number of characters that represents the recommended maximum length of the value. Where possible, the valid ranges for numbers are specified, however each range should be consulted as to their specific capabilities. There are several special values for Range:
  - Enumeration: This specifies that the value must be one of the values listed in the description column of the attribute. The enumerations will follow.
  - Floating Point: This specifies a legal floating point, integer, or scientific notation value.
  - xxx.xxx.xxx.xxx: This specifies an Internet Protocol (IP) address where each “xxx” is a value from 0-255.
  - Hexadecimal: A numeric value base 16 containing 0-9 and A-F or a-f.
  - Binary: A numeric value base 2 containing 0-1
  - Binary pattern: A binary numeric pattern consisting of 0, 1, or “X” for don’t care.
  - “X”: the character “X”
  - MM-DD-YYYY-HH-MI-SS: This specifies a date and time. MM is the month from 01 to 12. DD is the day of the month from 01 to 31. YYYY is the 4 digit year. HH is the hour of the day from 00 to 23. MI is the minute of the hour from 00 to 59. SS is the second from 00 to 59.
- Default: This identifies the default value required to process a TMATS file when the file itself does not contain the attribute.

 <p><b>NOTE</b></p>	<p>In previous versions of this document, there existed code name tags *R-CH10*, *RO-CH10* and *RO-CH10-PAK*. These have been removed in favor of the above attribute column. If the R/R Ch10 Status field is “R”, then the attribute must be included in the TMATS file if all other conditions apply even if it has a default.</p>
--	--

- b. Group Relationships. Representative interrelationships between the various groups are shown pictorially in [Figure 9-1](#). Not all valid paths are shown. All valid paths are documented in “Links to:” and “Links from:” attributes.

**NOTE**



- a. Data Source ID is unique within a General Information group (G). It ties the Transmission group (T) or the Recorder-Reproducer group (R) or both to the G group and to the Multiplex/Modulation group (M).
- b. The tie from the M group to a PCM group (P) is the Data Link Name.
- c. The tie from the P group to an embedded P group is another Data Link Name.
- d. The tie from the M group to the Data Conversion group (C) for an analog measurement is the Measurement Name.
- e. The tie from the P group to the PCM Measurement Description group (D) or Bus group (B) is the Data Link Name.
- f. The tie from the R group to the P group is from the Channel Data Link Name (R) to the Data Link Name (P).
- g. The tie from the R group to the B group is from the Channel Data Link Name or Sub-Channel Name (R) to the Data Link Name (B).
- h. The tie from the R group to the Message Data group (S) or Message Structure Definition Group (Q) is from the Channel Data Link Name, Sub-Channel Name, or Network Name (R) to the Data Link Name (S) or Data Link Name (Q).
- i. The tie from either the R, D, B, or S group to the Data Conversion group is the Measurement Name.



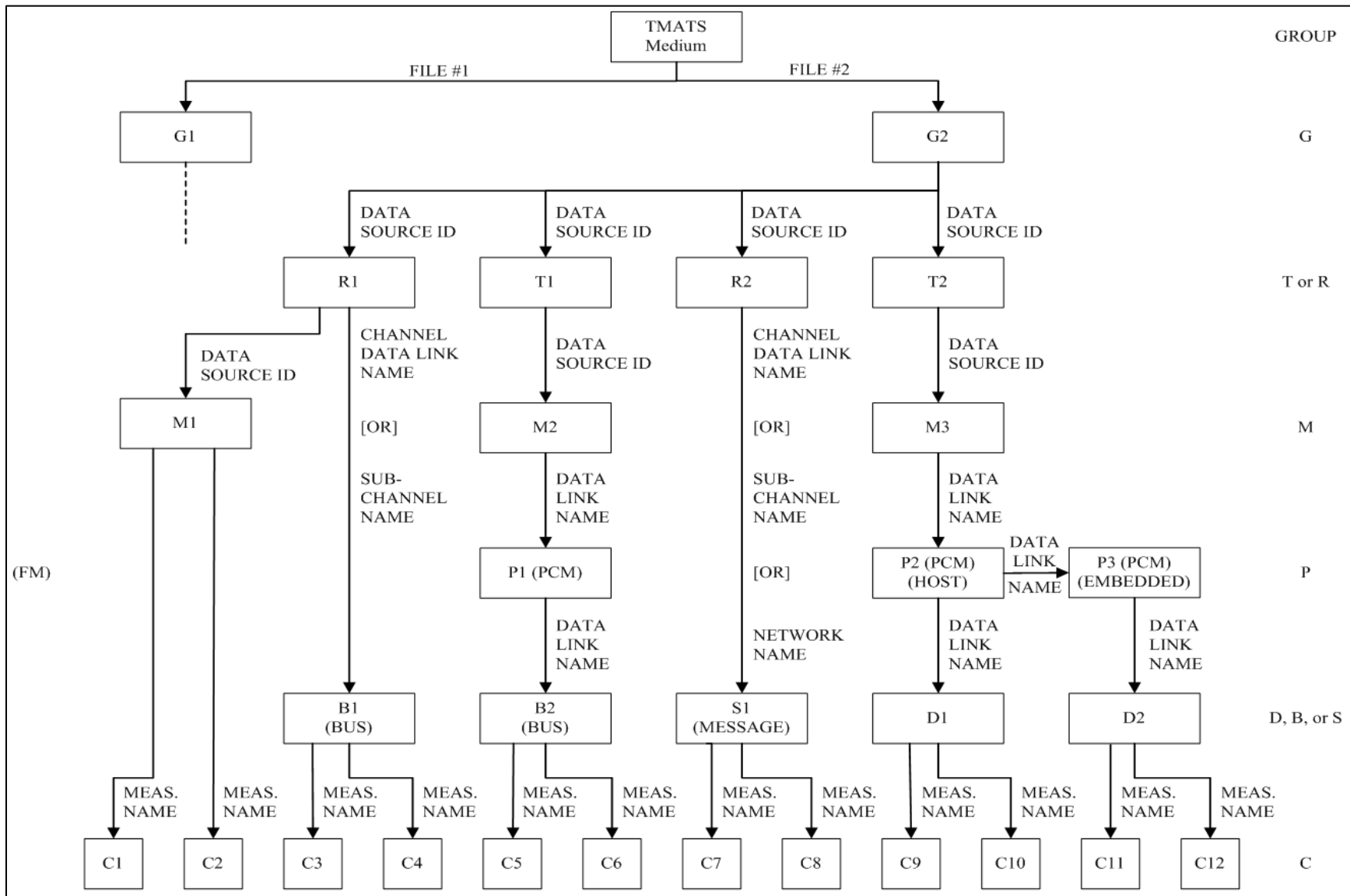

Figure 9-1. Group Relationships

9.5.2 General Information Attributes (G)

The General Information group provides overall program information. [Figure 9-2](#) below gives the overall information that is included in this group. [Table 9-2](#) identifies and defines the data required, including the dates associated with the detailed information. Since the identification of the data sources is an integral part of the remaining groups, each source must be uniquely identified.

<b>Figure 9-2. General Information Group (G)</b>		Code Name
PROGRAM NAME - <a href="#">9-10</a>		(G\PN)
<a href="#">9-10</a>	TEST ITEM	(G\TA)
<b>*Information</b>		
	TMATS FILE NAME	(G\FN)
	RCC IRIG 106 REVISION LEVEL	(G\106)
	ORIGINATION DATE	(G\OD)
	REVISION NUMBER	(G\RN)
	REVISION DATE	(G\RD)
	UPDATE NUMBER	(G\UN)
	UPDATE DATE	(G\UD)
	TEST NUMBER	(G\TN)
	NUMBER OF POINTS OF CONTACT	(G\POC\N)
<a href="#">9-10</a>	<b>*Point of Contact</b>	
	NAME	(G\POC1-n)
	AGENCY	(G\POC2-n)
	ADDRESS	(G\POC3-n)
	TELEPHONE	(G\POC4-n)
<a href="#">9-11</a>	<b>*Data Source Identification</b>	
	NUMBER OF DATA SOURCES	(G\DSI\N)
	DATA SOURCE ID	(G\DSI-n)
	DATA SOURCE TYPE	(G\DSI-n)
	DATA SOURCE SECURITY CLASSIFICATION	(G\DSI-n)
<a href="#">9-12</a>	<b>*Test Information</b>	
	TEST DURATION	(G\TI1)
	PRE-TEST REQUIREMENT	(G\TI2)
	POST-TEST REQUIREMENT	(G\TI3)
	SECURITY CLASSIFICATION	(G\SC)
<a href="#">9-13</a>	<b>*TMATS Checksum</b>	
	MESSAGE DIGEST/CHECKSUM	(G\SHA)
<a href="#">9-13</a>	<b>* Comments</b>	
	COMMENTS	(G\COM)
*Heading Only - No Data Entry		

**Table 9-2. General Information Group (G)**

<b>Parameter</b>	<b>Code Name</b>	<b>Usage Attributes</b>	<b>Definition</b>
PROGRAM NAME	G\PN	Allowed when: Always	Name of program.
		Range: 16 characters	
TEST ITEM	G\TA	Allowed when: Always	Test item description in terms of name, model, platform, or identification code, as appropriate.
		Range: 64 characters	
<b>Information</b>			
TMATS FILE NAME	G\FN	Allowed when: Always	Name of this TMATS file.
		Range: 256 characters	
RCC IRIG 106 REVISION LEVEL	G\106	R/R Ch 10 Status: R	Version of RCC IRIG 106 standard used to generate this TMATS file. The last 2 digits of the year should be used. Use a leading 0 if necessary.
		Allowed when: Always	
		Required when: Always	
		Range: 0 to 99	
ORIGINATION DATE	G\OD	Allowed when: Always	Date of origination of this mission configuration. “DD” (Day). “MM” (Month). “YYYY” (Year).
		Range: MM-DD-YYYY	
REVISION NUMBER	G\RN	Allowed when: Always	Revision number associated with this mission configuration.
		Range: 0 to 9999	
REVISION DATE	G\RD	Allowed when: Always	Date of revision. “DD” (Day). “MM” (Month). “YYYY” (Year).
		Range: MM-DD-YYYY	
UPDATE NUMBER	G\UN	Allowed when: Always	Update number of current change that has not been incorporated as a revision.
		Range: 0 to 99	
UPDATE DATE	G\UD	Allowed when: Always	Date of update. “DD” (Day). “MM” (Month). “YYYY” (Year).
		Range: MM-DD-YYYY	
TEST NUMBER	G\TN	Allowed when: Always	Test identification.
		Range: 16 characters	
NUMBER OF POINTS OF CONTACT	G\POC\N	Allowed when: Always	Number of points of contact to be given.
		Range: 0 to 9	
		Default: 0	
<b>Point of Contact</b>			
NAME	G\POC1-n	Allowed when: G\POC\N > 0	Identify the name point of contact for additional information.
		Range: 24 characters	

**Table 9-2. General Information Group (G)**

Parameter	Code Name	Usage Attributes	Definition	
AGENCY	G\POC2-n	Allowed when: G\POC\N > 0	Identify the agency point of contact for additional information.	
		Range: 48 characters		
ADDRESS	G\POC3-n	Allowed when: G\POC\N > 0	Identify the address point of contact for additional information.	
		Range: 48 characters		
TELEPHONE	G\POC4-n	Allowed when: G\POC\N > 0	Identify the telephone point of contact for additional information.	
		Range: 20 characters		
Data Source Identification				
NUMBER OF DATA SOURCES	G\DSI\N	R/R Ch 10 Status: R	Specify the number of data sources: for RF telemetry systems, give the number of carriers; for tape or storage recorded data, identify the number of tape or storage sources.	
		Allowed when: Always		
		Required when: Allowed		
		Range: 1 to 99		
DATA SOURCE ID	G\DSI-n	R/R Ch 10 Status: R	Provide a descriptive name for this source. Each source identifier must be unique.	
		Allowed when: G\DSI\N > 0		
		Required when: Allowed		
		Links to: R-x\ID, T-x\ID, M-x\ID, V-x\ID		
DATA SOURCE TYPE	G\DST-n	R/R Ch 10 Status: R	Specify the type of source.	
		Allowed when: G\DSI\N > 0		
		Required when: Allowed		
		Range: Enumeration		
		Enumeration		Description
		RF		Radio Frequency
		TAP		Tape
		STO		Storage
		REP		Reproducer
		DSS		Distributed source
		DRS		Direct source
		OTH		Other

**Table 9-2. General Information Group (G)**

Parameter	Code Name	Usage Attributes	Definition	
DATA SOURCE SECURITY CLASSIFICATION	G\DSC-n	Allowed when: G\DSI\N > 0	Provide the classification of the data for this source. Provide a description of the classification guide and any information concerning declassification and/or downgrading in comments. For Digital Recorder Data Sources, this specifies the classification and distribution statements of the data file produced by the Recorder.	
		Range: 2048 Characters		
<b>NOTE:</b> Provide the above three items for each data source.				
<b>Test Information</b>				
TEST DURATION	G\TI1	Allowed when: Always	Approximate duration of test in hours.	
		Range: 0 to 9999		
PRE-TEST REQUIREMENT	G\TI2	Allowed when: Always	Indicate whether a pre-test requirement is applicable. Provide details in comments.	
		Range: Enumeration		
		Enumeration		Description
		Y		Yes
		N		No
Default: N				
POST-TEST REQUIREMENT	G\TI3	Allowed when: Always	Specify whether a post-test requirement is applicable. Provide details in comments.	
		Range: Enumeration		
		Enumeration		Description
		Y		Yes
		N		No
Default: N				
SECURITY CLASSIFICATION	G\SC	Allowed when: Always	Provide the classification of the TMATS file. Provide a description of the classification guide and any information concerning declassification and/or downgrading in comments.	
		Range: 2048 Characters		



**Table 9-2. General Information Group (G)**

<b>Parameter</b>	<b>Code Name</b>	<b>Usage Attributes</b>	<b>Definition</b>
<b>TMATS Checksum</b>			
MESSAGE DIGEST/ CHECKSUM	G\SHA	Allowed when: Always	Provide a message digest / checksum of the TMATS. The entire contents of the TMATS file except the characters from “G\SHA:” to the following “;” (inclusive) shall be used to calculate the checksum. The value integer is an algorithm designator and the hex digits are the checksum. SHA2-256 shall be represented as “2-” followed by 64 hex characters. See Subsection 6.2.3.11.f for more information.
		Range: integer followed by “-” followed by hex characters	
<b>Comments</b>			
COMMENTS	G\COM	Allowed when: Always	Provide the additional information requested or any other information desired.
		Range: 1600 characters	

9.5.3 Transmission Attributes (T)

The Transmission attributes are presented graphically in [Figure 9-3](#) and specified in [Table 9-3](#). The information contained within this group is used to set up the RF receiver through the detection and recovery of the baseband composite waveform. The format contains the information needed to configure the antenna and receiver subsystems.

Additional equipment inserted in a specific range configuration, such as microwave or other relay, is intended to be transparent to the user and is not described under Transmission Attributes.

Because the information is mutually exclusive, only the appropriate FM or PM system data set is required for a link.

<b>Figure 9-3. Transmission Attributes Group (T)</b>		Code Name
<b>DATA SOURCE ID - <a href="#">9-16</a></b>		(T-x\ID)
<a href="#">9-17</a> <a href="#">9-17</a> <a href="#">9-17</a> <a href="#">9-18</a> <a href="#">9-18</a> <a href="#">9-18</a> <a href="#">9-19</a>	<b>*Source RF Attributes</b>	
	TRANSMITTER ID	(T-x\TID)
	FREQUENCY	(T-x\RF1)
	RF BANDWIDTH	(T-x\RF2)
	DATA BANDWIDTH	(T-x\RF3)
	MODULATION TYPE	(T-x\RF4)
	TOTAL CARRIER MODULATION	(T-x\RF5)
	POWER (RADIATED)	(T-x\RF6)
	NUMBER OF SUBCARRIERS	(T-x\SCO\N)
	SUBCARRIER NUMBER	(T-x\SCO1-n)
	MODULATION INDEX	(T-x\SCO2-n)
	MODULATOR NON-LINEARITY	(T-x\RF7)
	<b>*Premodulation Filter</b>	
	BANDWIDTH	(T-x\PMF1)
	SLOPE	(T-x\PMF2)
	TYPE	(T-x\PMF3)
	<b>*Transmit Antenna</b>	
	TRANSMIT ANTENNA TYPE	(T-x\AN1)
	TRANSMIT POLARIZATION	(T-x\AN2)
	ANTENNA LOCATION	(T-x\AN3)
<b>*Antenna Patterns</b>		
DOCUMENT	(T-x\AP)	
<b>*Point of Contact</b>		
NAME	(T-x\AP\POC1)	
AGENCY	(T-x\AP\POC2)	
ADDRESS	(T-x\AP\POC3)	
TELEPHONE	(T-x\AP\POC4)	
<b>*Ground Station Attributes</b>		
IF BANDWIDTH	(T-x\GST1)	
BASEBAND COMPOSITE BANDWIDTH	(T-x\GST2)	
<b>*Gain Control</b>		

		AGC TIME CONSTANT	(T-x\GST3)
	OR	MGC GAIN SET POINT	(T-x\GST4)
		AFC/APC	(T-x\GST5)
		TRACKING BANDWIDTH	(T-x\GST6)
<a href="#">9-19</a>		POLARIZATION RECEPTION	(T-x\GST7)
<a href="#">9-20</a>		<b>*FM Systems</b>	
		DISCRIMINATOR BANDWIDTH	(T-x\FM1)
		DISCRIMINATOR LINEARITY	(T-x\FM2)
<a href="#">9-20</a>	OR	<b>*PM Systems</b>	
		PHASE LOCK LOOP BANDWIDTH	(T-x\PLL)
		<b>*Comments</b>	
<a href="#">9-20</a>		COMMENTS	(T-x\COM)
<b>*Heading Only - No Data Entry</b>			

**Table 9-3. Transmission Attributes Group (T)**

Parameter	Code Name	Usage Attributes	Definition	
DATA SOURCE ID	T-x\ID	Allowed when: Always	Data source ID consistent with General Information group.	
		Required when: defining Transmitter attributes		
		Links from: G\DSI-n		
		Links to: M-x\ID		
		Range: 32 characters		
<b>Source RF Attributes</b>				
TRANSMITTER ID	T-x\TID	Allowed when: T-x\ID specified	Transmitter identification.	
		Range: 12 characters		
FREQUENCY	T-x\RF1	Allowed when: T-x\ID specified	Carrier frequency, in megahertz (MHz). If programmable, enter “P” and define in comments.	
		Range: 6 characters		
RF BANDWIDTH	T-x\RF2	Allowed when: T-x\ID specified	Total RF bandwidth (-60 decibel [dB]) of modulated signal, in MHz.	
		Range: 6 characters		
DATA BANDWIDTH	T-x\RF3	Allowed when: T-x\ID specified	Composite baseband data bandwidth (3 dB), in kilohertz (kHz).	
		Range: 6 characters		
MODULATION TYPE	T-x\RF4	Allowed when: T-x\ID specified	Define the modulation type.	
		Range: Enumeration		
		Enumeration		Description
		FM		
		PM		
		BPSK		
		DPSK		
		QPSK		
		FQPSK-B		
		FQPSK-JR		
		SOQPSK-TG		
		MULTI-H-CPM		
OTHR				

**Table 9-3. Transmission Attributes Group (T)**

Parameter	Code Name	Usage Attributes	Definition	
TOTAL CARRIER MODULATION	T-x\RF5	Allowed when: T-x\ID specified	For FM system, define total carrier deviation, peak-to-peak, in kHz. For PM system, define total phase modulation, peak-to-peak, in radians.	
		Range: 6 characters		
POWER (RADIATED)	T-x\RF6	Allowed when: T-x\ID specified	Total transmitted power when modulated, in watts.	
		Range: 4 characters		
NUMBER OF SUBCARRIERS	T-x\SCO\N	Allowed when: T-x\ID specified	Number of subcarriers in the composite baseband waveform, n. If none, enter "NO".	
		Range: 0 to 99, "NO"		
		Default: NO		
SUBCARRIER NUMBER	T-x\SCO1-n	Allowed when: T-x\SCO\N > 0	Give the IRIG channel number for the subcarrier. If nonstandard subcarrier, enter "NO" and enter frequency in the comments section where n is an identification tag for the subcarrier.	
		Required when: Allowed		
		Range: 5 characters		
MODULATION INDEX	T-x\SCO2-n	Allowed when: T-x\SCO\N > 0	Specify the modulation index for each subcarrier in the composite waveform, as appropriate.	
		Range: 4 characters		
MODULATOR NONLINEARITY	T-x\RF7	Allowed when: T-x\ID is specified	Modulator nonlinearity, in percent.	
		Range: Floating point 0 to 100		
		Default: 0		
<b>Premodulation Filter</b>				
BANDWIDTH	T-x\PMF1	Allowed when: T-x\ID is specified	Pre-modulation composite filter bandwidth, 3 dB cut-off frequency, in kHz.	
		Range: 6 characters		
SLOPE	T-x\PMF2	Allowed when: T-x\ID is specified	Pre-modulation filter asymptotic roll-off slope, dB/octave.	
		Range: 2 characters		
TYPE	T-x\PMF3	Allowed when: T-x\ID is specified	Specify the filter type.	
		Range: Enumeration		
		Enumeration		Description
		CA		Constant amplitude
		CD		Constant delay
		OT		Other

**Table 9-3. Transmission Attributes Group (T)**

Parameter	Code Name	Usage Attributes	Definition	
<b>Transmit Antenna</b>				
TRANSMIT ANTENNA TYPE	T-x\AN1	Allowed when: T-x\ID is specified	Transmit antenna type.	
		Range: 16 characters		
TRANSMIT POLARIZATION	T-x\AN2	Allowed when: T-x\ID is specified	Transmit antenna polarization.	
		Range: Enumeration		
		Enumeration		Description
		RHCP		
		LHCP		
LIN	linear			
ANTENNA LOCATION	T-x\AN3	Allowed when: T-x\ID is specified	Describe the antenna location.	
		Range: 16 characters		
<b>Antenna Patterns</b>				
DOCUMENT	T-x\AP	Allowed when: T-x\ID is specified	Identify document having antenna patterns.	
		Range: 16 characters		
<b>Point of Contact</b>				
NAME	T-x\AP\POC1	Allowed when: T-x\ID is specified	Identify the name point of contact for additional information.	
		Range: 24 characters		
AGENCY	T-x\AP\POC2	Allowed when: T-x\ID is specified	Identify the agency point of contact for additional information.	
		Range: 48 characters		
ADDRESS	T-x\AP\POC3	Allowed when: T-x\ID is specified	Identify the address point of contact for additional information.	
		Range: 48 characters		
TELEPHONE	T-x\AP\POC4	Allowed when: T-x\ID is specified	Identify the telephone point of contact for additional information.	
		Range: 20 characters		
<b>Ground Station Attributes</b>				
IF BANDWIDTH	T-x\GST1	Allowed when: T-x\ID is specified	Define IF bandwidth (3 dB) in MHz.	
		Range: 6 characters		
BASEBAND COMPOSITE BANDWIDTH	T-x\GST2	Allowed when: T-x\ID is specified	Define the cutoff frequency (3 dB), of the output filter, in kHz.	
		Range: 6 characters		

**Table 9-3. Transmission Attributes Group (T)**

Parameter	Code Name	Usage Attributes	Definition	
<b>Gain Control</b>				
AGC TIME CONSTANT	T-x\GST3	Allowed when: T-x\ID is specified	Specify the AGC time constant desired in milliseconds.	
		Range: 4 characters		
MGC GAIN SET POINT	T-x\GST4	Allowed when: T-x\ID is specified	Provide the manual gain control set point in terms of received signal strength, dBm.	
		Range: 6 characters		
AFC/APC	T-x\GST5	Allowed when: T-x\ID is specified	Specify automatic frequency control, automatic phase control, or none.	
		Range: Enumeration		
		Enumeration		Description
		AFC		automatic frequency control
		APC		automatic phase control
		NON		none
		Default: NON		
TRACKING BANDWIDTH	T-x\GST6	Allowed when: T-x\ID is specified	Specify tracking loop bandwidth, in hertz (Hz).	
		Range: 4 characters		
POLARIZATION RECEPTION	T-x\GST7	Allowed when: T-x\ID is specified	Specify polarization to be used.	
		Range: Enumeration		
		Enumeration		Description
		RHCP		
		LHCP		
		BOTH		
		Both with diversity combining:		
		B&DPR		Pre-detection
		B&DPO		Post-detection
		Diversity combining only:		
		PRE-D		Pre-detection
		POS-D		Post-detection
		OTHER		Specify in comments

**Table 9-3. Transmission Attributes Group (T)**

<b>Parameter</b>	<b>Code Name</b>	<b>Usage Attributes</b>	<b>Definition</b>
<b>FM Systems</b>			
DISCRIMINATOR BANDWIDTH	T-x\FM1	Allowed when: T-x\ID is specified	Specify the discriminator bandwidth required, in MHz.
		Range: 4 characters	
DISCRIMINATOR LINEARITY	T-x\FM2	Allowed when: T-x\ID is specified	Specify the required linearity over the bandwidth specified.
		Range: 4 characters	
<b>PM Systems</b>			
PHASE LOCK LOOP BANDWIDTH	T-x\PLL	Allowed when: T-x\ID is specified	Specify the phase-locked loop bandwidth.
		Range: 4 characters	
<b>Comments</b>			
COMMENTS	T-x\COM	Allowed when: T\ID is specified	Provide the additional information requested or any other information desired.
		Range: 1600	



9.5.4 Recorder-Reproducer Attributes (R)

This group describes the attributes required when the data source is a magnetic tape as specified in [Annex A.2](#) or a data storage device as specified in [Chapter 10](#). In the case of the tape data link identification, each data source must be identified. In some cases, the data source identification may be identical, particularly when the same information has been received from different receiver sites, on different polarizations, or on different carriers for redundancy purposes. Some of the information requested will be available only from the recording site or the dubbing location.

[Figure 9-4](#) indicates the information required. Various categories of information have been included. In the data section of the attributes, it will be necessary to repeat the items until all of the data sources, including the multiple tracks, have been defined that contain ground station data of interest. [Table 9-4](#) defines the information required. Any nonstandard tape recordings will require explanation in the comments and may require supplemental definition.

Recorder-reproducer filtering and post-process data filtering and overwrite will use TMATS attributes to describe the requirements. Recorder-reproducer channel types that support filtering and overwrite will define these attributes. The PCM channels will use R, P, and D attributes and the bus channels will use R and B attributes to define filtering and overwrite definitions.

<b>Figure 9-4. Recorder-Reproducer Attributes Group (R)</b>		<b>Code Name</b>
<b>DATA SOURCE ID - <a href="#">9-30</a></b>		(R-x\ID)
<a href="#">9-30</a>	RECORDER-REPRODUCER ID	(R-x\RID)
	RECORDER-REPRODUCER DESCRIPTION	(R-x\R1)
<a href="#">9-30</a>	<b>*Recorder-Reproducer Media Characteristics</b>	
	RECORDER-REPRODUCER MEDIA TYPE	(R-x\TC1)
	RECORDER-REPRODUCER MEDIA MFG	(R-x\TC2)
	RECORDER-REPRODUCER MEDIA CODE	(R-x\TC3)
	RECORDER-REPRODUCER MEDIA LOCATION	(R-x\RML)
	EXTERNAL RMM BUS SPEED	(R-x\ERBS)
	TAPE WIDTH	(R-x\TC4)
	TAPE HOUSING	(R-x\TC5)
	TYPE OF TRACKS	(R-x\TT)
	NUMBER OF TRACKS/CHANNELS	(R-x\N)
	RECORD SPEED	(R-x\TC6)
	DATA PACKING DENSITY	(R-x\TC7)
	TAPE REWOUND	(R-x\TC8)
	NUMBER OF SOURCE BITS	(R-x\NSB)
<a href="#">9-33</a>	<b>*Recorder-Reproducer Information</b>	
	RECORDER-REPRODUCER MANUFACTURER	(R-x\RI1)
	RECORDER-REPRODUCER MODEL	(R-x\RI2)
	ORIGINAL RECORDING	(R-x\RI3)
	ORIGINAL RECORDING DATE AND TIME	(R-x\RI4)
<a href="#">9-33</a>	<b>*Creating Organization Point of Contact</b>	
	NAME	(R-x\POC1)

9-34	AGENCY	(R-x\POC2)	
	ADDRESS	(R-x\POC3)	
	TELEPHONE	(R-x\POC4)	
	DATE AND TIME OF COPY	(R-x\RI5)	
	<b>*Copying Organization Point of Contact</b>		
	NAME	(R-x\DPOC1)	
	AGENCY	(R-x\DPOC2)	
	ADDRESS	(R-x\DPOC3)	
	TELEPHONE	(R-x\DPOC4)	
	POST PROCESS MODIFIED RECORDING	(R-x\RI6)	
	POST PROCESS MODIFICATION TYPE	(R-x\RI7)	
	DATE AND TIME OF MODIFICATION	(R-x\RI8)	
	<b>*Modifying Organization Point of Contact</b>		
	NAME	(R-x\MPOC1)	
	AGENCY	(R-x\MPOC2)	
	ADDRESS	(R-x\MPOC3)	
	TELEPHONE	(R-x\MPOC4)	
	CONTINUOUS RECORDING ENABLED	(R-x\CRE)	
	RECORDER-REPRODUCER SETUP SOURCE	(R-x\RSS)	
	RECORDER SERIAL NUMBER	(R-x\RI9)	
	RECORDER FIRMWARE REVISION	(R-x\RI10)	
	NUMBER OF MODULES	(R-x\RIM\N)	
	MODULE ID	(R-x\RIMI-n)	
	MODULE SERIAL NUMBER	(R-x\RIMS-n)	
	MODULE FIRMWARE REVISION	(R-x\RIMF-n)	
	NUMBER OF RMMS	(R-x\RMM\N)	
	RMM IDENTIFIER	(R-x\RMMID-n)	
	RMM SERIAL NUMBER	(R-x\RMMS-n)	
	RMM FIRMWARE REVISION	(R-x\RMMF-n)	
	<b>* Recorder-Reproducer Ethernet Interfaces</b>		
	NUMBER OF ETHERNET INTERFACES	(R-x\EI\N)	
	ETHERNET INTERFACE NAME	(R-x\EINM-n)	
	PHYSICAL ETHERNET INTERFACE	(R-x\PEIN-n)	
	ETHERNET INTERFACE LINK SPEED	(R-x\EILS-n)	
	ETHERNET INTERFACE TYPE	(R-x\EIT-n)	
	ETHERNET INTERFACE IP ADDRESS	(R-x\EIIP-n)	
	NUMBER OF ETHERNET INTERFACE PORTS	(R-x\EIIP\N-n)	
	PORT ADDRESS	(R-x\EI\PA-n-m)	
	PORT TYPE	(R-x\EI\PT-n-m)	
	<b>* Recorder-Reproducer Channel Group Streams</b>		
NUMBER OF CHANNEL GROUPS	(R-x\CG\N)		
CHANNEL GROUP NAME	(R-x\CGNM-n)		
CHANNEL GROUP STREAM NUMBER	(R-x\CGSN-n)		
NUMBER OF GROUP CHANNELS	(R-x\CGCH\N-n)		

	GROUP CHANNEL NUMBER	(R-x\CGCN-n-m)
	<b>* Recorder-Reproducer Drives and Volumes</b>	
	NUMBER OF DRIVES	(R-x\DR\N)
	DRIVE NAME	(R-x\DRNM-n)
	DRIVE NUMBER	(R-x\DRN-n)
	DRIVE BLOCK SIZE	(R-x\DRBS-n)
	NUMBER OF DRIVE VOLUMES	(R-x\DRVL\N-n)
	VOLUME NAME	(R-x\VLNM-n-m)
	VOLUME NUMBER	(R-x\VLN-n-m)
	VOLUME BLOCKS TO ALLOCATE	(R-x\VLBA-n-m)
	VOLUME NUMBER OF BLOCKS	(R-x\VLNB-n-m)
	<b>* Recorder-Reproducer Stream/Drive-Volume Links</b>	
	NUMBER OF LINKS	(R-x\L\N)
	LINK NAME	(R-x\LNM-n)
	LINK SOURCE STREAM NAME	(R-x\LSNM-n)
	LINK SOURCE STREAM NUMBER	(R-x\LSSN-n)
	LINK DESTINATION DRIVE NUMBER	(R-x\LDDN-n)
	LINK DESTINATION VOLUME NUMBER	(R-x\LDVN-n)
	<b>* Recorder-Reproducer Ethernet Interface Publishing Links</b>	
	NUMBER OF ETHERNET PUBLISHING LINKS	(R-x\EPL\N)
	LINK NAME	(R-x\EPL\LNM-n)
	LINK SOURCE STREAM NAME	(R-x\EPL\LSNM-n)
	LINK SOURCE STREAM NUMBER	(R-x\EPL\LSSN-n)
	LINK DESTINATION ETHERNET INTERFACE IP ADDRESS	(R-x\EPL\LDEIP-n)
	LINK DESTINATION ETHERNET INTERFACE PORT ADDRESS	(R-x\EPL\LDEPA-n)
	<b>* Computer-Generated Data Packet, User-Defined Definition</b>	
	USER-DEFINED CHANNEL ID	(R-x\UD\TK1)
<a href="#">9-42</a>	<b>*Recording Event Definitions</b>	
	RECORDING EVENTS ENABLED	(R-x\EV\E)
	RECORDING EVENTS CHANNEL ID	(R-x\EV\TK1)
	NUMBER OF RECORDING EVENTS	(R-x\EV\N)
	RECORDER INTERNAL EVENTS ENABLED	(R-x\EV\IEE)
<a href="#">9-43</a>	<b>*Recording Event</b>	
	EVENT ID	(R-x\EV\ID-n)
	EVENT DESCRIPTION	(R-x\EV\D-n)
	EVENT DATA PROCESSING ENABLED	(R-x\EV\EDP-n)
	EVENT TYPE	(R-x\EV\T-n)
<a href="#">9-44</a>	EVENT PRIORITY	(R-x\EV\P-n)
	EVENT CAPTURE MODE	(R-x\EV\CM-n)

		EVENT INITIAL CAPTURE	(R-x\EV\IC-n)
		RECORDING EVENT LIMIT COUNT	(R-x\EV\LC-n)
		EVENT TRIGGER MEASUREMENT SOURCE	(R-x\EV\MS-n)
		EVENT TRIGGER MEASUREMENT NAME	(R-x\EV\MN-n)
		EVENT PROCESSING MEASUREMENT DATA LINK NAME	(R-x\EV\DLN-n)
		NUMBER OF MEASUREMENTS TO PROCESS	(R-x\EV\PM\N-n)
		MEASUREMENT NAME TO PROCESS	(R-x\EV\PM\MN-n-m)
		PRE-EVENT PROCESSING DURATION	(R-x\EV\PM\PRE-n-m)
		POST-EVENT PROCESSING DURATION	(R-x\EV\PM\PST-n-m)
<a href="#">9-46</a>	<b>*Recording Index</b>		
		RECORDING INDEX ENABLED	(R-x\IDX\E)
		RECORDING INDEX CHANNEL ID	(R-x\IDX\TK1)
		RECORDING INDEX TYPE	(R-x\IDX\IT)
<a href="#">9-46</a>		<b>* Time Index Type Attribute</b>	
		INDEX TIME VALUE	(R-x\IDX\ITV)
	OR	<b>* Count Index Type Attribute</b>	
		INDEX COUNT VALUE	(R-x\IDX\ICV)
<a href="#">9-47</a>	<b>*MIL-STD-1553 Recorder Control</b>		
		MESSAGE MONITOR RECORD CONTROL ENABLED	(R-x\MRC\E)
		CHANNEL ID NUMBER	(R-x\MRC\ID)
		MESSAGE RECORD CONTROL TYPE	(R-x\MRC\RCT)
		STOP-PAUSE COMMAND WORD	(R-x\MRC\SPM)
		START-RESUME COMMAND WORD	(R-x\MRC\SRM)
	<b>*Data</b>		
		TRACK NUMBER/ CHANNEL ID	(R-x\TK1-n)
		RECORDING TECHNIQUE	(R-x\TK2-n)
		INPUT STREAM DERANDOMIZATION	(R-x\IDDR-n)
<a href="#">9-48</a>		DATA SOURCE ID	(R-x\DSI-n)
<a href="#">9-48</a>		DATA DIRECTION	(R-x\TK3-n)
		RECORDER PHYSICAL CHANNEL NUMBER	(R-x\TK4-n)
		CHANNEL ENABLE	(R-x\CHE-n)
		CHANNEL DATA TYPE	(R-x\CDT-n)
		CHANNEL DATA LINK NAME	(R-x\CDLN-n)
		SECONDARY HEADER TIME FORMAT	(R-x\SHTF-n)
		<b>*Data Type Attributes</b>	
<a href="#">9-50</a>		<b>*PCM Data Type Attributes</b>	
		PCM DATA TYPE FORMAT	(R-x\PDTF-n)
		DATA PACKING OPTION	(R-x\PDP-n)
		RECORDER POLARITY SETTING	(R-x\RPS-n)
		INPUT CLOCK EDGE	(R-x\ICE-n)
		INPUT SIGNAL TYPE	(R-x\IST-n)
		INPUT THRESHOLD	(R-x\ITH-n)

9-55	OR	INPUT TERMINATION	(R-x\ITM-n)
		PCM VIDEO TYPE FORMAT	(R-x\PTF-n)
		PCM RECORDER-REPRODUCER MINOR FRAME FILTERING ENABLED	(R-x\MFF\E-n)
		PCM POST PROCESS OVERWRITE AND FILTERING ENABLED	(R-x\POF\E-n)
		PCM POST PROCESS OVERWRITE AND FILTERING TYPE	(R-x\POF\T-n)
		MINOR FRAME FILTERING DEFINITION TYPE	(R-x\MFF\FDT-n)
		NUMBER OF MINOR FRAME FILTERING DEFINITIONS	(R-x\MFF\N-n)
		FILTERED MINOR FRAME NUMBER	(R-x\MFF\MFN-n-m)
		RECORDER POLARITY SETTING	(R-x\MFF\RPS-n-m)
		NUMBER OF SELECTED MEASUREMENT OVERWRITE DEFINITIONS	(R-x\SMF\N-n)
		SELECTED MEASUREMENT NAME	(R-x\SMF\SMN-n-m)
		MEASUREMENT OVERWRITE TAG	(R-x\SMF\MFOT-n-m)
		<b>*MIL-STD-1553 Bus Data Type Attributes</b>	
		MIL-STD-1553 BUS DATA TYPE FORMAT	(R-x\BTF-n)
		MIL-STD-1553 RECORDER-REPRODUCER FILTERING ENABLED	(R-x\MRF\E-n)
		MIL-STD-1553 POST PROCESS OVERWRITE AND FILTERING ENABLED	(R-x\MOF\T-n)
		MIL-STD-1553 MESSAGE FILTERING DEFINITION TYPE	(R-x\MFD\FDT-n)
		NUMBER OF MESSAGE FILTERING DEFINITIONS	(R-x\MFD\N-n)
		MESSAGE NUMBER	(R-x\MFD\MID-n-m)
		MESSAGE TYPE	(R-x\MFD\MT-n-m)
		COMMAND WORD ENTRY	(R-x\CWE-n-m)
		COMMAND WORD	(R-x\CMD-n-m)
		REMOTE TERMINAL ADDRESS	(R-x\MFD\TRA-n-m)
		TRANSMIT/RECEIVE MODE	(R-x\MFD\TRM-n-m)
		SUBTERMINAL ADDRESS	(R-x\MFD\STA-n-m)
		DATA WORD COUNT/MODE CODE	(R-x\MFD\DWC-n-m)
		RECEIVE COMMAND WORD ENTRY	(R-x\RCWE-n-m)
		RECEIVE COMMAND WORD	(R-x\RCMD-n-m)
		RT/RT REMOTE TERMINAL ADDRESS	(R-x\MFD\RTRA-n-m)
		RT/RT SUBTERMINAL ADDRESS	(R-x\MFD\RSTA-n-m)
		RT/RT DATA WORD COUNT	(R-x\MFD\RDWC-n-m)

<a href="#">9-59</a>	OR	NUMBER OF SELECTED MEASUREMENT OVERWRITE DEFINITIONS	(R-x)\BME\N-n)
		SELECTED MEASUREMENT NAME	(R-x)\BME\SMN-n-m)
<a href="#">9-60</a>	OR	MEASUREMENT OVERWRITE TAG	(R-x)\BME\MFOT-n-m)
		<b>*Analog Data Type Attributes</b>	
<a href="#">9-64</a>	OR	ANALOG DATA TYPE FORMAT	(R-x)\ATF-n)
		NUMBER OF ANALOG CHANNELS/PKT	(R-x)\ACH\N-n)
<a href="#">9-66</a>	OR	DATA PACKING OPTION	(R-x)\ADP-n)
		SAMPLE RATE	(R-x)\ASR-n)
<a href="#">9-66</a>	OR	SUB CHANNEL ENABLED	(R-x)\AMCE-n-m)
		SUB CHANNEL NUMBER	(R-x)\AMCN-n-m)
<a href="#">9-66</a>	OR	MEASUREMENT NAME	(R-x)\AMN-n-m)
		DATA LENGTH	(R-x)\ADL-n-m)
<a href="#">9-66</a>	OR	BIT MASK	(R-x)\AMSK-n-m)
		MEASUREMENT TRANSFER ORDER	(R-x)\AMTO-n-m)
<a href="#">9-66</a>	OR	SAMPLE FACTOR	(R-x)\ASF-n-m)
		SAMPLE FILTER 3DB BANDWIDTH	(R-x)\ASBW-n-m)
<a href="#">9-66</a>	OR	AC/DC COUPLING	(R-x)\ACP-n-m)
		RECORDER INPUT IMPEDANCE	(R-x)\AII-n-m)
<a href="#">9-66</a>	OR	INPUT CHANNEL GAIN	(R-x)\AGI-n-m)
		INPUT FULL SCALE RANGE	(R-x)\AFSI-n-m)
<a href="#">9-66</a>	OR	INPUT OFFSET VOLTAGE	(R-x)\AOVI-n-m)
		RECORDED ANALOG FORMAT	(R-x)\AF-n-m)
<a href="#">9-66</a>	OR	INPUT TYPE	(R-x)\AIT-n-m)
		AUDIO	(R-x)\AV-n-m)
<a href="#">9-66</a>	OR	AUDIO FORMAT	(R-x)\AVF-n-m)
		ANALOG CENTER FREQUENCY	(R-x)\ACF-n)
<a href="#">9-66</a>	OR	ANALOG INTERMEDIATE FREQUENCY	(R-x)\AIF-n)
		<b>*Discrete Data Type Attributes</b>	
<a href="#">9-66</a>	OR	DISCRETE DATA TYPE FORMAT	(R-x)\DTF-n)
		DISCRETE MODE	(R-x)\DMOD-n)
<a href="#">9-66</a>	OR	SAMPLE RATE	(R-x)\DSR-n)
		NUMBER OF DISCRETE MEASUREMENTS	(R-x)\NDM\N-n)
<a href="#">9-66</a>	OR	MEASUREMENT NAME	(R-x)\DMN-n-m)
		BIT MASK	(R-x)\DMSK-n-m)
<a href="#">9-66</a>	OR	MEASUREMENT TRANSFER ORDER	(R-x)\DMTO-n-m)
		<b>*ARINC 429 Bus Data Type Attributes</b>	
<a href="#">9-66</a>	OR	ARINC 429 BUS DATA TYPE FORMAT	(R-x)\ABTF-n)
		NUMBER OF ARINC 429 BUSSES	(R-x)\NAS\N-n)
<a href="#">9-66</a>	OR	ARINC 429 BUS NUMBER	(R-x)\ASN-n-m)
		ARINC 429 BUS NAME	(R-x)\ANM-n-m)
<a href="#">9-66</a>	OR	<b>*Video Data Type Attributes</b>	
		VIDEO DATA TYPE FORMAT	(R-x)\VTF-n)

		MPEG-2 CHANNEL XON2 FORMAT	(R-x\VXF-n)
		VIDEO SIGNAL TYPE	(R-x\VST-n)
		VIDEO SIGNAL FORMAT TYPE	(R-x\VSF-n)
		VIDEO CONSTANT BIT RATE	(R-x\CBR-n)
		VIDEO VARIABLE PEAK BIT RATE	(R-x\VBR-n)
		VIDEO ENCODING DELAY	(R-x\VED-n)
		OVERLAY ENABLED	(R-x\VCO\OE-n)
		OVERLAY X POSITION	(R-x\VCO\X-n)
		OVERLAY Y POSITION	(R-x\VCO\Y-n)
		OVERLAY EVENT TOGGLE ENABLED	(R-x\VCO\OET-n)
		OVERLAY FORMAT	(R-x\VCO\OLF-n)
		OVERLAY BACKGROUND	(R-x\VCO\OBG-n)
		ANALOG AUDIO CHANNEL INPUT LEFT	(R-x\ASI\ASL-n)
		ANALOG AUDIO CHANNEL INPUT RIGHT	(R-x\ASI\ASR-n)
		VIDEO DATA ALIGNMENT	(R-x\VDA-n)
		VIDEO FRAME DESCRIPTION	(R-x\VFD-n)
		VIDEO CODEC INFORMATION	(R-x\VCI-n)
		VIDEO AUDIO CHANNELS	(R-x\VAC-n)
		VIDEO AUDIO ENCODING	(R-x\VAA-n)
		VIDEO METADATA PRESENCE	(R-x\VMD-n)
	VIDEO METADATA TYPE	(R-x\VMT-n)	
<a href="#">9-71</a>	OR	<b>*Time Data Type Attributes</b>	
		TIME DATA TYPE FORMAT	(R-x\TTF-n)
		TIME FORMAT	(R-x\TFMT-n)
		TIME SOURCE	(R-x\TSRC-n)
<a href="#">9-72</a>	OR	<b>*Image Data Type Attributes</b>	
		IMAGE DATA TYPE FORMAT	(R-x\ITF-n)
		STILL IMAGE TYPE	(R-x\SIT-n)
		DYNAMIC IMAGE FORMAT	(R-x\DIF-n)
		IMAGE TIME STAMP MODE	(R-x\ITSM-n)
		DYNAMIC IMAGE ACQUISITION MODE	(R-x\DIAM-n)
		IMAGE FRAME RATE	(R-x\IFR-n)
		PRE-TRIGGER FRAMES	(R-x\PTG-n)
		TOTAL FRAMES	(R-x\TOTF-n)
		EXPOSURE TIME	(R-x\EXP-n)
		SENSOR ROTATION	(R-x\ROT-n)
		SENSOR GAIN VALUE	(R-x\SGV-n)
		SENSOR AUTO GAIN	(R-x\SAG-n)
		SENSOR WIDTH	(R-x\ISW-n)
		SENSOR HEIGHT	(R-x\ISH-n)
		MAX IMAGE WIDTH	(R-x\MIW-n)
		MAX IMAGE HEIGHT	(R-x\MIH-n)
		IMAGE WIDTH	(R-x\IW-n)



		IMAGE HEIGHT	(R-x\IH-n)
		IMAGE OFFSET X	(R-x\IOX-n)
		IMAGE OFFSET Y	(R-x\IOY-n)
		LINE PITCH	(R-x\ILP-n)
		BINNING HORIZONTAL	(R-x\IBH-n)
		BINNING VERTICAL	(R-x\IBV-n)
		DECIMATION HORIZONTAL	(R-x\IDH-n)
		DECIMATION VERTICAL	(R-x>IDV-n)
		REVERSE X	(R-x\IRX-n)
		REVERSE Y	(R-x\IRY-n)
		PIXEL DYNAMIC RANGE MINIMUM	(R-x\IPMN-n)
		PIXEL DYNAMIC RANGE MAXIMUM	(R-x\IPMX-n)
		TEST IMAGE TYPE	(R-x\TIT-n)
<a href="#">9-77</a>	OR	<b>*UART Data Type Attributes</b>	
		UART DATA TYPE FORMAT	(R-x\UTF-n)
		NUMBER OF UART SUB-CHANNELS	(R-x\NUS\N-n)
		UART SUB-CHANNEL NUMBER	(R-x\USCN-n-m)
		UART SUB-CHANNEL NAME	(R-x\UCNM-n-m)
		UART SUB-CHANNEL BAUD RATE	(R-x\UCR-n-m)
		UART SUB-CHANNEL BITS PER WORD	(R-x\UCB-n-m)
		UART SUB-CHANNEL PARITY	(R-x\UCP-n-m)
		UART SUB-CHANNEL STOP BIT	(R-x\UCS-n-m)
		UART SUB-CHANNEL INTERFACE	(R-x\UCIN-n-m)
		UART SUB-CHANNEL BLOCK SIZE	(R-x\UCBS-n-m)
		UART SUB-CHANNEL SYNC WORD LENGTH	(R-x\UCSL-n-m)
		UART SUB-CHANNEL BLOCK SYNC VALUE	(R-x\UCSV-n-m)
		UART SUB-CHANNEL BLOCK RATE	(R-x\UCBR-n-m)
<a href="#">9-79</a>	OR	<b>*Message Data Type Attributes</b>	
		MESSAGE DATA TYPE FORMAT	(R-x\MTF-n)
		NUMBER OF MESSAGE SUB-CHANNELS	(R-x\NMS\N-n)
		MESSAGE SUB-CHANNEL NUMBER	(R-x\MSCN-n-m)
		MESSAGE SUB-CHANNEL NAME	(R-x\MCNM-n-m)
<a href="#">9-80</a>	OR	<b>*IEEE-1394 Data Type Attributes</b>	
		IEEE-1394 DATA TYPE FORMAT	(R-x\IETF-n)
		MESSAGE FILTERING TYPE	(R-x\IEMFT-n)
		SUB-MESSAGE FILTERING TYPE	(R-x\IESMT-n)
<a href="#">9-80</a>	OR	<b>*Parallel Data Type Attributes</b>	
		PARALLEL DATA TYPE FORMAT	(R-x\PLTF-n)
<a href="#">9-80</a>	OR	<b>*Ethernet Data Type Attributes</b>	
		ETHERNET DATA TYPE FORMAT	(R-x\ENTF-n)
		NUMBER OF ETHERNET NETWORKS	(R-x\NNET\N-n)
		ETHERNET NETWORK NUMBER	(R-x\ENBR-n-m)



<a href="#">9-81</a>	OR	ETHERNET NETWORK NAME	(R-x\ENAM-n-m)
		MESSAGE FILTERING TYPE	(R-x\ENMFT-n)
		SUB-MESSAGE FILTERING TYPE	(R-x\ENSFT-n)
<a href="#">9-82</a>	OR	<b>*TSPI/CTS Data Type Attributes</b>	
		TSPI/CTS DATA TYPE FORMAT	(R-x\TDTF-n)
<a href="#">9-83</a>	OR	<b>*CAN Bus Data Type Attributes</b>	
		CAN BUS DATA TYPE FORMAT	(R-x\CBTF-n)
		NUMBER OF CAN BUS SUB-CHANNELS	(R-x\NCB\N-n)
<a href="#">9-83</a>	OR	CAN BUS SUB-CHANNEL NUMBER	(R-x\CBN-n-m)
		CAN BUS SUB-CHANNEL NAME	(R-x\CBM-n-m)
		CAN BUS BIT RATE	(R-x\CBBS-n-m)
		<b>*Fibre Channel Data Type Attributes</b>	
<a href="#">9-83</a>	OR	FIBRE CHANNEL DATA TYPE FORMAT	(R-x\FCTF-n)
		FIBRE CHANNEL SPEED	(R-x\FCSP-n)
		MESSAGE FILTERING TYPE	(R-x\FCMFT-n)
		SUB-MESSAGE FILTERING TYPE	(R-x\FCSFT-n)
<a href="#">9-83</a>	OR	<b>*Telemetry Output Attributes</b>	
		OUTPUT STREAM NAME	(R-x\OSNM-n)
		STREAM ID	(R-x\SID-n)
		CONFIGURATION HASH RATE	(R-x\HRATE-n)
		CONFIGURATION PACKET RATE	(R-x\CRATE-n)
<a href="#">9-83</a>	<b>*Reference Track</b>		
		NUMBER OF REFERENCE TRACKS	(R-x\RT\N)
		TRACK NUMBER	(R-x\RT1-n)
<a href="#">9-84</a>		REFERENCE FREQUENCY	(R-x\RT2-n)
	<b>*Comments</b>		
		COMMENTS	(R-x\COM)
*Heading Only - No Data Entry			

**Table 9-4. Recorder-Reproducer Attributes Group (R)**

<b>Parameter</b>	<b>Code Name</b>	<b>Usage Attributes</b>	<b>Definition</b>	
DATA SOURCE ID	R-x\ID	R/R Ch 10 Status: R	Data source ID consistent with General Information group.	
		Allowed when: Always		
		Links from: G\DSI-n		
		Required when: defining a recorder		
RECORDER-REPRODUCER ID	R-x\RID	R/R Ch 10 Status: R	Recorder-reproducer identification.	
		Allowed when: R\ID is specified		
		Required when: Allowed		
		Range: 32 characters		
RECORDER-REPRODUCER DESCRIPTION	R-x\R1	Allowed when: R\ID is specified	Recorder-reproducer description.	
		Range: 32 characters		
<b>Recorder-Reproducer Media Characteristics</b>				
RECORDER-REPRODUCER MEDIA TYPE	R-x\TC1	Allowed when: R\ID is specified	Specify the recorder-reproducer media type.	
		Range: Enumeration		
		Enumeration		Description
		ANAL		Analog
		CASS		Cassette
		HDDR		High Density Digital Recorder
		PARA		Parallel
		SSR		Solid State Recorder
		MD		Magnetic Disk
		N		None, Data Publishing Only
OTHR	Other, define in comments			
RECORDER-REPRODUCER MEDIA MANUFACTURER	R-x\TC2	Allowed when: R\TC1 is not "N"	Name of manufacturer of the recorder-reproducer media.	
		Range: 8 characters		

**Table 9-4. Recorder-Reproducer Attributes Group (R)**

Parameter	Code Name	Usage Attributes	Definition	
RECORDER-REPRODUCER MEDIA CODE	R-x\TC3	Allowed when: R\TC1 is not "N"	Specify manufacturer's recorder-reproducer media designation code.	
		Range: 8 characters		
RECORDER-REPRODUCER MEDIA LOCATION	R-x\RML	R/R Ch 10 Status: R	Indicate the location of the recorder-reproducer media.	
		Allowed when: R\TC1 is not "N"		
		Required when: Allowed		
		Range: Enumeration		
		Enumeration		Description
		I		Internal
		E		External
B	Both internal and external			
EXTERNAL RMM BUS SPEED	R-x\ERBS	R/R Ch 10 Status: RO	Indicate the speed of an external RMM IEEE-1394b bus.	
		Allowed when: R\TC1 is not "N"		
		Required when: Allowed		
		Range: Enumeration		
		Enumeration		Description
		AUTO		Speed set by host device
		S100		100 Mbps
		S200		200 Mbps
		S400		400 Mbps
		S800		800 Mbps
		S1600		1600 Mbps
S3200	3200 Mbps			
TAPE WIDTH	R-x\TC4	Allowed when: R\TC1 is "ANAL" or "CASS"	Physical dimension of tape width, in inches.	
		Range: Floating point 0.00 to 9.99		
TAPE HOUSING	R-x\TC5	Allowed when: R\TC1 is "ANAL" or "CASS"	State the reel size.	
		Range: Enumeration		
		Enumeration		Description
		10.5		10.5 Inches

**Table 9-4. Recorder-Reproducer Attributes Group (R)**

Parameter	Code Name	Usage Attributes		Definition
		14.0	14.0 Inches	
		15.0	15.0 Inches	
		16.0	16.0 Inches	
		12.65	12.65 Millimeters	
		19.0	19.0 Millimeters	
		OTHER	Other	
TYPE OF TRACKS	R-x\TT	Allowed when: R\TC1 is "ANAL" or "CASS"		State the type of tracks on the tape.
		Range: Enumeration		
		Enumeration	Description	
		LO	Longitudinal	
		RO	Rotary	
NUMBER OF TRACKS/ CHANNELS	R-x\N	R/R Ch 10 Status: R		State the number of tracks on the tape or the number of channels on the storage media.
		Allowed when: R\TC1 is not "N"		
		Required when: Always		
		Range: 1 to 65536		
RECORD SPEED	R-x\TC6	Allowed when: R\TC1 is "ANAL" or "CASS"		State record speed (inches/second).
		Range: Floating point 00.0 to 99.9		
DATA PACKING DENSITY	R-x\TC7	Allowed when: R\TC1 is "ANAL" or "CASS"		State recording system bandwidth.
		Range: Enumeration		
		Enumeration	Description	
		IM	Intermediate band	
		WB	Wide band	
		DD	Double density	
OT	Other			
TAPE REWOUND	R-x\TC8	Allowed when: R\TC1 is "ANAL" or "CASS"		Name of tape rewind.
		Range: Enumeration		
		Enumeration	Description	
		Y	Yes	
		N	No	

**Table 9-4. Recorder-Reproducer Attributes Group (R)**

Parameter	Code Name	Usage Attributes	Definition	
NUMBER OF SOURCE BITS	R-x\NSB	R/R Ch 10 Status: R	Number of most significant bits (msbs) of the channel ID used for multiplexer source ID. Specify 0 for one source.	
		Allowed when: R\ID is specified		
		Required when: Allowed		
		Range: 0 to 13		
<b>Recorder-Reproducer Information</b>				
RECORDER-REPRODUCER MANUFACTURER	R-x\RI1	Allowed when: R\ID is specified	Name of recorder-reproducer device manufacturer.	
		Range: 64 characters		
RECORDER-REPRODUCER MODEL	R-x\RI2	Allowed when: R\ID is specified	Manufacturer's model number of recorder-reproducer device used to create the recording.	
		Range: 64 characters		
ORIGINAL RECORDING	R-x\RI3	R/R Ch 10 Status: R	Indicate if this is an original recording from the source.	
		Allowed when: R\TC1 is not "N"		
		Required when: Allowed		
		Range: Enumeration		
		Enumeration		Description
		Y		Yes
N	No			
ORIGINAL RECORDING DATE AND TIME	R-x\RI4	Allowed when: R\TC1 is not "N"	Date and time original recording was created using the format defined in Subsection 9.5.1. Example 08-19-2014-17-33-59.	
		Range: Custom date and time		
<b>Creating Organization Point of Contact</b>				
CREATING ORGANIZATION POC NAME	R-x\POC1	Allowed when: R\TC1 is not "N"	Identify the creating organization POC name for additional information	
		Range: 24 characters		
CREATING ORGANIZATION POC AGENCY	R-x\POC2	Allowed when: R\TC1 is not "N"	Identify the creating organization POC agency for additional information	
		Range: 48 characters		

**Table 9-4. Recorder-Reproducer Attributes Group (R)**

<b>Parameter</b>	<b>Code Name</b>	<b>Usage Attributes</b>	<b>Definition</b>	
CREATING ORGANIZATION POC ADDRESS	R-x\POC3	Allowed when: R\TC1 is not "N"	Identify the creating organization POC address for additional information	
		Range: 48 characters		
CREATING ORGANIZATION POC TELEPHONE	R-x\POC4	Allowed when: R\TC1 is not "N"	Identify the creating organization POC telephone for additional information.	
		Range: 20 characters		
DATE AND TIME OF COPY	R-x\RI5	R/R Ch 10 Status: RO	Date and time the copy was made using the format defined in Subsection 9.5.1. Example 08-19-2014-17-33-59	
		Allowed when: R\TC1 is not "N"		
		Range: Custom date and time		
<b>Copying Organization Point of Contact</b>				
COPYING ORGANIZATION POC NAME	R-x\DPOC1	Allowed when: R\TC1 is not "N".	Identify the copying organization POC name for additional information	
		Range: 24 characters		
COPYING ORGANIZATION POC AGENCY	R-x\DPOC2	Allowed when: R\TC1 is not "N".	Identify the copying organization POC agency for additional information.	
		Range: 48 characters.		
COPYING ORGANIZATION POC ADDRESS	R-x\DPOC3	Allowed when: R\TC1 is not "N".	Identify the copying organization POC address for additional information.	
		Range: 48 characters.		
COPYING ORGANIZATION POC TELEPHONE	R-x\DPOC4	Allowed when: R\TC1 is not "N"	Identify the copying organization POC telephone for additional information.	
		Range: 20 characters		
POST PROCESS MODIFIED RECORDING	R-x\RI6	R/R Ch 10 Status: R	Indicate modified recording.	
		Allowed when: R\TC1 is not "N"		
		Required when: Allowed		
		Range: Enumeration		
		Enumeration		Description
		Y		Yes
N	No			

**Table 9-4. Recorder-Reproducer Attributes Group (R)**

<b>Parameter</b>	<b>Code Name</b>	<b>Usage Attributes</b>	<b>Definition</b>	
POST PROCESS MODIFICATION TYPE	R-x\RI7	R/R Ch 10 Status: RO	Indicate the type of post-process modification to the recording.	
		Allowed when: R\TC1 is not "N"		
		Range: Enumeration		
		Enumeration		Description
		1		Time subset
		2		Channel subset
		3		Time – channel subset
		4		Channel superset
5	Time subset – channel superset			
6	Filter			
7	Overwrite			
DATE AND TIME OF MODIFICATION	R-x\RI8	R/R Ch 10 Status: RO	Date and time the modification was made using the format defined in Subsection 9.5.1. Example 08-19-2014-17-33-59	
		Allowed when: R\TC1 is not "N"		
		Range: Custom date and time		
<b>Modifying Organization Point of Contact</b>				
MODIFYING ORGANIZATION POC NAME	R-x\MPOC1	Allowed when: R\TC1 is not "N".	Identify the modifying organization POC name for additional information	
		Range: 24 characters		
MODIFYING ORGANIZATION POC AGENCY	R-x\MPOC2	Allowed when: R\TC1 is not "N".	Identify the modifying organization POC agency for additional information.	
		Range: 48 characters		
MODIFYING ORGANIZATION POC ADDRESS	R-x\MPOC3	Allowed when: R\TC1 is not "N".	Identify the modifying organization POC address for additional information.	
		Range: 48 characters		
MODIFYING ORGANIZATION POC TELEPHONE	R-x\MPOC4	Allowed when: R\TC1 is not "N"	Identify the copying organization POC telephone for additional information.	
		Range: 20 characters		

**Table 9-4. Recorder-Reproducer Attributes Group (R)**

<b>Parameter</b>	<b>Code Name</b>	<b>Usage Attributes</b>	<b>Definition</b>	
CONTINUOUS RECORDING ENABLED	R-x\CRE	R/R Ch 10 Status: R	Indicate if continuous recording is enabled.	
		Allowed when: R\TC1 is not "N"		
		Required when: Allowed		
		Range: Enumeration		
		Enumeration		Description
		T		True
F	False			
RECORDER-REPRODUCER SETUP SOURCE	R-x\RSS	R/R Ch 10 Status: R	Indicate the recorder-reproducer setup source.	
		Allowed when: R\ID is specified		
		Required when: Allowed		
		Range: Enumeration		
		Enumeration		Description
		R		Setup file on RMM only
		C		Command setup file only
		RP		RMM primary, command secondary
CP	Command primary, RMM secondary			
RECORDER SERIAL NUMBER	R-x\RI9	Allowed when: R\ID is specified	Serial number of the recorder.	
		Range: 64 characters		
RECORDER FIRMWARE REVISION	R-x\RI10	Allowed when: R\ID is specified	Firmware revision number for the recorder.	
		Range: 256 characters		
NUMBER OF MODULES	R-x\RIM\N	Allowed when: R\ID is specified	Number of modules in the recorder.	
		Range: 1-999		
MODULE ID	R-x\RIMI-n	Allowed when: R\RIM\N > 0	Identify this module.	
		Range: 64 characters		
MODULE SERIAL NUMBER	R-x\RIMS-n	Allowed when: R\RIM\N > 0	Serial number of this module.	
		Range: 64 characters		



**Table 9-4. Recorder-Reproducer Attributes Group (R)**

Parameter	Code Name	Usage Attributes	Definition	
MODULE FIRMWARE REVISION	R-x\RIMF-n	Allowed when: R\RIM\N > 0	Firmware revision number for this module.	
		Range: 256 characters		
NUMBER OF RMMS	R-x\RMM\N	Allowed when: R\RIM\N > 0	Number of RMMS.	
		Range: 1 to 99		
RMM IDENTIFIER	R-x\RMMID-n	Allowed when: R\RMM\N > 0	Identify this RMM.	
		Range: 64 characters		
RMM SERIAL NUMBER	R-x\RMMS-n	Allowed when: R\RMM\N > 0	Serial number of the RMM.	
		Range: 64 characters		
RMM FIRMWARE REVISION	R-x\RMMF-n	Allowed when: R\RMM\N > 0	Firmware revision number of the RMM.	
		Range: 256 characters		
<b>Recorder-Reproducer Ethernet Interfaces</b>				
NUMBER OF ETHERNET INTERFACES	R-x\EI\N	R/R Ch 10 Status: RO	Number of recorder-reproducer Ethernet interfaces.	
		Allowed when: R\ID is specified		
		Range: 0 to 99		
ETHERNET INTERFACE NAME	R-x\EINM-n	R/R Ch 10 Status: RO	Name of the recorder-reproducer Ethernet interface.	
		Allowed when: R\EI\N > 0		
		Range: 32 characters		
PHYSICAL ETHERNET INTERFACE	R-x\PEIN-n	R/R Ch 10 Status: RO	Number of the recorder-reproducer physical Ethernet interface	
		Allowed when: R\EI\N > 0		
		Range: 0 to 99		
ETHERNET INTERFACE LINK SPEED	R-x\EILS-n	R/R Ch 10 Status: RO	Ethernet interface link speed.	
		Allowed when: R\EI\N > 0		
		Range: Enumeration		
		Enumeration		Description
		Enumeration		Description
		0		Auto Negotiated
		1		10Mbps
		2		100Mbps

**Table 9-4. Recorder-Reproducer Attributes Group (R)**

Parameter	Code Name	Usage Attributes		Definition
		3	1Gbps	
		4	10Gbps	
ETHERNET INTERFACE TYPE	R-x\EIT-n	R/R Ch 10 Status: RO		Type of recorder-reproducer Ethernet interface.
		Allowed when: R\EI\N > 0		
		Range: Enumeration		
		Enumeration	Description	
		0	Reserved	
		1	Download	
		2	Data streaming	
		3	Download and Data streaming	
		4	Control and status	
		5	Download and Control and status	
6	Data streaming and Control and status			
7	Download, Data streaming and Control and status			
ETHERNET INTERFACE IP ADDRESS	R-x\EIIP-n	R/R Ch 10 Status: RO		Recorder-reproducer Ethernet interface IP address: specify the IP address in the form “xxx.xxx.xxx.xxx” where each group of xxx can range from 0 to 255.
		Allowed when: R\EI\N > 0		
		Range: xxx.xxx.xxx.xxx		
		Links from: R-x\EPL\LDEIP-n		
NUMBER OF ETHERNET INTERFACE PORTS	R-x\EIIP\N-n	R/R Ch 10 Status: RO		Number of Ethernet interface ports.
		Allowed when: R\EI\N > 0		
		Range: 0 to 99		
PORT ADDRESS	R-x\EI\PA-n-m	R/R Ch 10 Status: RO		Recorder-reproducer Ethernet interface IP port address: specify the IP address in the form “xxxxx” where xxxxx can range from 0 to 65535 IAW ITF.
		Allowed when: R\EI\N > 0		
		Range: 0 to 65535		
		Links from: R-x\EPL\LDEPA-n		

**Table 9-4. Recorder-Reproducer Attributes Group (R)**

Parameter	Code Name	Usage Attributes	Definition	
PORT TYPE	R-x\EI\PT-n-m	R/R Ch 10 Status: RO	Recorder-reproducer Ethernet interface IP port type.	
		Allowed when: R\EI\N > 0		
		Range: Enumeration		
		Enumeration		Description
		0		Reserved
		1		Download
		2		Data streaming
		4	Control and status	
		X	Sum values for multiple type	
<b>Recorder-Reproducer Channel Group Streams</b>				
NUMBER OF CHANNEL GROUPS	R-x\CG\N	R/R Ch 10 Status: RO	Number of recorder-reproducer channel group streams.	
		Allowed when: R\ID specified		
		Range: 0 to 99		
CHANNEL GROUP NAME	R-x\CGNM-n	R/R Ch 10 Status: RO	Name of the recorder-reproducer channel group. First character must be alphabetic.	
		Allowed when: R\CG\N > 0		
		Range: 32 characters		
		Links from: R-x\OSNM-n, R-x\EPL\LSNM-n		
CHANNEL GROUP STREAM NUMBER	R-x\CGSN-n	R/R Ch 10 Status: RO	Specify the channel group stream as an integer number.	
		Allowed when: R\CG\N > 0		
		Range: 1 to 99		
		Links from: R-x\EPL\LSSN-n		
NUMBER OF GROUP CHANNELS	R-x\CGCH\N-n	R/R Ch 10 Status: RO	Number of channels in the channel group stream.	
		Allowed when: R\CG\N > 0		
		Range: 1 to 65536		
GROUP CHANNEL NUMBER	R-x\CGCN-n-m	R/R Ch 10 Status: RO	Specify the channel ID, from R-x\TK1-n.	
		Allowed when: R\CG\N > 0		
		Range: 0 to 65535		

**Table 9-4. Recorder-Reproducer Attributes Group (R)**

Parameter	Code Name	Usage Attributes	Definition	
<b>Recorder-Reproducer Drives and Volumes</b>				
NUMBER OF DRIVES	R-x\DR\N	R/R Ch 10 Status: RO	Number of recorder-reproducer drives (stream destinations). Default is “1”.	
		Allowed when: R\ID is specified		
		Range: 0 to 9999		
DRIVE NAME	R-x\DRNM-n	R/R Ch 10 Status: RO	Name of the recorder-reproducer drive. First character must be alphabetic.	
		Allowed when: R\DR\N > 0		
		Range: 32 characters		
DRIVE NUMBER	R-x\DRN-n	R/R Ch 10 Status: RO	Specify the drive as an integer number.	
		Allowed when: R\DR\N > 0		
		Range: 1 to 9999		
DRIVE BLOCK SIZE	R-x\DRBS-n	R/R Ch 10 Status: RO	Specify the drive bytes per block size.	
		Allowed when: R\DR\N > 0		
		Range: 1 to 99999999		
NUMBER OF DRIVE VOLUMES	R-x\DRVL\N-n	R/R Ch 10 Status: RO	Number of volumes in the drive. Default is “1”.	
		Allowed when: R\DR\N > 0		
		Range: 1 to 9999		
VOLUME NAME	R-x\VLNM-n-m	R/R Ch 10 Status: RO	Name of the drive volume. First character must be alphabetic.	
		Allowed when: R\DR\N > 0		
		Range: 32 characters		
VOLUME NUMBER	R-x\VLN-n-m	R/R Ch 10 Status: RO	Specify the volume as an integer number.	
		Allowed when: R\DR\N > 0		
		Range: 1 to 9999		
VOLUME BLOCKS TO ALLOCATE	R-x\VLBA-n-m	R/R Ch 10 Status: RO	Specify how volume blocks will be allocated.	
		Allowed when: R\DR\N > 0		
		Range: Enumeration		
		Enumeration		Description
		0		All
		1		Available
2	Number of blocks			

**Table 9-4. Recorder-Reproducer Attributes Group (R)**

<b>Table 9-4. Recorder-Reproducer Attributes Group (R)</b>			
<b>Parameter</b>	<b>Code Name</b>	<b>Usage Attributes</b>	<b>Definition</b>
VOLUME NUMBER OF BLOCKS	R-x\VLNB-n-m	R/R Ch 10 Status: RO	Specify the volume as an integer number of blocks.
		Allowed when: R\DR\N > 0	
		Range: 1 to 999999999999999999999999999999	
<b>Recorder-Reproducer Stream/Drive-Volume Links</b>			
NUMBER OF LINKS	R-x\L\N	R/R Ch 10 Status: RO	Number of recorder-reproducer channel group streams/drive-volume links.
		Allowed when: R\ID is specified	
		Range: 0 to 99	
LINK NAME	R-x\LNM-n	R/R Ch 10 Status: RO	Name of the recorder-reproducer channel group stream/drive-volume link. First character must be alphabetic.
		Allowed when: R\L\N > 0	
		Range: 32 characters	
LINK SOURCE STREAM NAME	R-x\LSNM-n	R/R Ch 10 Status: RO	Specify the recorder-reproducer channel group stream name.
		Allowed when: R\L\N > 0	
		Range: 32 characters	
LINK SOURCE STREAM NUMBER	R-x\LSSN-n	R/R Ch 10 Status: RO	Specify the recorder-reproducer channel group stream/drive-volume number, from R-x\CGSN-n.
		Allowed when: R\L\N > 0	
		Range: 1 to 99	
LINK DESTINATION DRIVE NUMBER	R-x\LDDN-n	R/R Ch 10 Status: RO	Specify the recorder-reproducer channel group stream destination drive number, from R-x\DRN-n.
		Allowed when: R\L\N > 0	
		Range: 1 to 9999	
LINK DESTINATION VOLUME NUMBER	R-x\LDVN-n	R/R Ch 10 Status: RO	Specify the recorder-reproducer channel group stream destination volume number, from R-x\VLN-n-m.
		Allowed when: R\L\N > 0	
		Range: 1 to 9999	
<b>Recorder-Reproducer Ethernet Interface Publishing Links</b>			
NUMBER OF ETHERNET PUBLISHING LINKS	R-x\EPL\N	R/R Ch 10 Status: RO	Number of Stream/Ethernet Interface Publish Links
		Allowed when: R\ID is specified	
		Range: 0 to 99	

**Table 9-4. Recorder-Reproducer Attributes Group (R)**

<b>Parameter</b>	<b>Code Name</b>	<b>Usage Attributes</b>	<b>Definition</b>
ETHERNET PUBLISHING LINK NAME	R-x\EPL\LNM-n	R/R Ch 10 Status: RO	Name of Stream/Ethernet Interface Publish Links
		Allowed when: R\EPL\N > 0	
		Range: 32 characters	
LINK SOURCE STREAM NAME	R-x\EPL\LSNM-n	R/R Ch 10 Status: RO	The Channel Group Stream Name to link this Ethernet Publishing Interface.
		Allowed when: R\EPL\N > 0	
		Range: 32 characters Links to: R-x\CGNM-n	
LINK SOURCE STREAM NUMBER	R-x\EPL\LSSN-n	R/R Ch 10 Status: RO	The Channel Group Stream Number to link this Ethernet Publishing Interface from R-X\CGSN.
		Allowed when: R\EPL\N > 0	
		Range = 0-99 Links to: R-x\CGSN-n	
LINK DESTINATION ETHERNET INTERFACE IP ADRESS	R-x\EPL\LDEIP-n	R/R Ch 10 Status: RO	The Destination Ethernet interface IP address for this link.
		Allowed when: R\EPL\N > 0	
		Range: xxx.xxx.xxx.xxx Links to: R-x\EIIP-n	
LINK DESTINATION ETHERNET INTERFACE PORT ADDRESS	R-x\EPL\LDEPA-n	R/R Ch 10 Status: RO	The Destination Ethernet interface port address for this link.
		Allowed when: R\EPL\N > 0	
		Range: 0 to 65535 Links to: R-x\EI\PA	
<b>Computer-Generated Data Packet, User-Defined Definition</b>			
USER-DEFINED CHANNEL ID	R-x\UD\TK1	R/R Ch 10 Status: RO	Specify the channel ID for computer-generated user-defined packets.
		Allowed when: R\ID is specified	
		Range: 1 to 65535	
<b>Recording Event Definitions</b>			
RECORDING EVENTS ENABLED	R-x\EV\E	R/R Ch 10 Status: RO	Indicate if events are enabled. Events must be enabled to generate event packets.
		Allowed when: R\ID is specified	
		Range: Enumeration	

**Table 9-4. Recorder-Reproducer Attributes Group (R)**

<b>Table 9-4. Recorder-Reproducer Attributes Group (R)</b>				
<b>Parameter</b>	<b>Code Name</b>	<b>Usage Attributes</b>		<b>Definition</b>
		Enumeration	Description	
		T	True	
		F	False	
		Default: F		
RECORDING EVENTS CHANNEL ID	R-x\EV\TK1	R/R Ch 10 Status: RO		Specify the channel ID for recording event packets.
		Allowed when: R\EV\E = "T"		
		Required when: Allowed		
		Range: 1 to 65535		
NUMBER OF RECORDING EVENTS	R-x\EV\N	R/R Ch 10 Status: RO		Specify the number of individual recording event types.
		Allowed when: R\EV\E = "T"		
		Required when: Allowed		
		Range: 1 to 999		
RECORDER INTERNAL EVENTS ENABLED	R-x\EV\IEE	R/R Ch 10 Status: RO		Indicate if recorder internal events are enabled.
		Allowed when: R\EV\E = "T"		
		Required when: Allowed		
		Range: Enumeration		
		Enumeration	Description	
		T	True	
		F	False	
<b>Recording Event</b>				
EVENT ID	R-x\EV\ID-n	R/R Ch 10 Status: RO		Identify the name of the individual recording event.
		Allowed when: R\EV\N > 0		
		Range: 32 characters		
EVENT DESCRIPTION	R-x\EV\D-n	R/R Ch 10 Status: RO		Identify the description of the event.
		Allowed when: R\EV\N > 0		
		Range: 256 characters		
EVENT DATA PROCESSING ENABLED	R-x\EV\EDP-n	Allowed when: R\EV\N > 0		Indicate if event data processing is enabled.
		Range: Enumeration		
		Enumeration	Description	

**Table 9-4. Recorder-Reproducer Attributes Group (R)**

Parameter	Code Name	Usage Attributes		Definition
		T	True	
		F	False	
EVENT TYPE	R-x\EV\T-n	R/R Ch 10 Status: RO		Indicate the recording event type.
		Allowed when: R\EV\N > 0		
		Range: Enumeration		
		Enumeration	Description	
		E	External	
		D	Measurement discrete	
		L	Measurement limit	
		R	Recorder	
		O	Other	
Default: R				
EVENT PRIORITY	R-x\EV\P-n	R/R Ch 10 Status: RO		Indicate the recording event priority.
		Allowed when: R\EV\N > 0		
		Range: Enumeration		
		Enumeration	Description	
		1	Priority 1	
		2	Priority 2	
		3	Priority 3	
		4	Priority 4	
		5	Priority 5	
EVENT CAPTURE MODE	R-x\EV\CM-n	R/R Ch 10 Status: RO		Indicate the recording event capture mode.
		Allowed when: R\EV\N > 0		
		Range: Enumeration		
		Enumeration	Description	
		1	Mode 1	
		2	Mode 2	
		3	Mode 3	
4	Mode 4			



**Table 9-4. Recorder-Reproducer Attributes Group (R)**

Parameter	Code Name	Usage Attributes		Definition
		5	Mode 5	
		6	Mode 6	
		7	Mode 7	
EVENT INITIAL CAPTURE	R-x\EV\IC-n	R/R Ch 10 Status: RO		Indicate if initial capture of event is enabled.
		Allowed when: R\EV\N > 0		
		Range: Enumeration		
		Enumeration	Description	
		T	True	
F	False			
RECORDING EVENT LIMIT COUNT	R-x\EV\LC-n	R/R Ch 10 Status: RO		Specify the limit count for the individual recording event.
		Allowed when: R\EV\N > 0		
		Range: 1 to 99999999		
EVENT TRIGGER MEASUREMENT SOURCE	R-x\EV\MS-n	R/R Ch 10 Status: RO		Identify the data link name consistent with the mux/mod group that contains the event trigger measurement if event type is “D” or “L”.
		Allowed when: R\EV\N > 0		
		Range: 32 characters		
EVENT TRIGGER MEASUREMENT NAME	R-x\EV\MN-n	R/R Ch 10 Status: RO		Identify the event trigger measurand name if the event type is “D” or “L”.
		Allowed when: R\EV\N > 0		
		Range: 32 characters		
EVENT PROCESSING MEASUREMENT DATA LINK NAME	R-x\EV\DLN-n	Allowed when: R\EV\N > 0		Identify the data link name consistent with the PCM format and PCM measurement groups, bus data group, or message data group that contains the measurements to be processed.
		Links to: P-d\DLN, B-x\DLN, S-d\DLN		
		Range: 32 characters		
NUMBER OF MEASUREMENTS TO PROCESS	R-x\EV\PM\N-n	Allowed when: R\EV\N > 0		Specify the number of measurements to process for this event.
		Range: 0 to 9999		
MEASUREMENT NAME TO PROCESS	R-x\EV\PM\MN-n-m	Allowed when: R\EV\PM\N > 0		Identify the measurement name to be processed for the event.
		Links to: B-x\MN-i-n-p, D-x\MN-y-n, S-d\MN-i-n-p		

**Table 9-4. Recorder-Reproducer Attributes Group (R)**

Parameter	Code Name	Usage Attributes	Definition						
		Range: 32 characters							
PRE-EVENT PROCESSING DURATION	R-x\EV\PM\PRE-n-m	Allowed when: R\EV\PM\N > 0 Range: 0 to 9999	Specify the number of seconds the measurement will be processed before the event time.						
POST-EVENT PROCESSING DURATION	R-x\EV\PM\PST-n-m	Allowed when: R\EV\PM\N > 0 Range: 0 to 9999	Specify the number of seconds the measurement will be processed after the event time.						
<b>Recording Index</b>									
RECORDING INDEX ENABLED	R-x\IDX\E	R/R Ch 10 Status: RO Allowed when: R\ID is specified Range: Enumeration <table border="1" style="width: 100%; border-collapse: collapse;"> <thead> <tr> <th style="width: 50%;">Enumeration</th> <th style="width: 50%;">Description</th> </tr> </thead> <tbody> <tr> <td>T</td> <td>True</td> </tr> <tr> <td>F</td> <td>False</td> </tr> </tbody> </table>	Enumeration	Description	T	True	F	False	Indicate if index is enabled. Index must be enabled to generate index packets.
Enumeration	Description								
T	True								
F	False								
RECORDING INDEX CHANNEL ID	R-x\IDX\TK1	R/R Ch 10 Status: RO Allowed when: R\IDX\E = "T" Required when: Allowed Range: 1 to 65535	Specify the channel ID for recording index packets.						
RECORDING INDEX TYPE	R-x\IDX\IT	R/R Ch 10 Status: RO Allowed when: R\IDX\E = "T" Required when: Allowed Range: Enumeration <table border="1" style="width: 100%; border-collapse: collapse;"> <thead> <tr> <th style="width: 50%;">Enumeration</th> <th style="width: 50%;">Description</th> </tr> </thead> <tbody> <tr> <td>T</td> <td>Time</td> </tr> <tr> <td>C</td> <td>Count</td> </tr> </tbody> </table>	Enumeration	Description	T	Time	C	Count	Specify index type for recording index packets.
Enumeration	Description								
T	Time								
C	Count								
<b>Time Index Type Attribute</b>									
INDEX TIME VALUE	R- IDX\ITV	R/R Ch 10 Status: RO Allowed when: R\IDX\E = "T" Range: 0 to 99999999	Identify the number of microseconds for each index entry generation.						

**Table 9-4. Recorder-Reproducer Attributes Group (R)**

Parameter	Code Name	Usage Attributes	Definition	
<b>Count Index Type Attribute</b>				
INDEX COUNT VALUE	R-\IDX\ICV	R/R Ch 10 Status: RO	Identify the number of packets for each index entry generation.	
		Allowed when: R\IDX\E = "T"		
		Range: 0 to 9999		
<b>MIL-STD-1553 Recorder Control</b>				
MESSAGE MONITOR RECORD CONTROL ENABLED	R-x\MRC\E	Allowed when: R\ID is specified	Indicate if message monitor record control is enabled.	
		Range: Enumeration		
		Enumeration		Description
		T		True
		F		False
CHANNEL ID NUMBER	R-x\MRC\ID	Allowed when: R\MRC\E = "T"	Specify the MIL-STD-1553 channel ID that contains the record control message.	
		Range: 1 to 65535		
MESSAGE RECORD CONTROL TYPE	R-x\MRC\RCT	Allowed when: R\MRC\E = "T"	Specify the MIL-STD-1553 message monitor record control type.	
		Range: Enumeration		
		Enumeration		Description
		0		Stop-start
		1		Pause-resume
STOP-PAUSE COMMAND WORD	R-x\MRC\SPM	Allowed when: R\MRC\E = "T"	Specify the command word of the MIL-STD-1553 message to be used for stop-pause.	
		Range: Hexadecimal, 0000-FFFF		
START-RESUME COMMAND WORD	R-x\MRC\SRM	Allowed when: R\MRC\E = "T"	Specify the command word of the MIL-STD-1553 message to be used for start-resume.	
		Range: Hexadecimal, 0000-FFFF		
<b>Data</b>				
<b>NOTE:</b> Define information contained on each track of the tape or each channel of the storage media.				
TRACK NUMBER/ CHANNEL ID	R-x\TK1-n	R/R Ch 10 Status: R	Specify the track number or the channel ID that contains the data to be specified.	
		Allowed when: R\N > 0		
		Required when: Allowed		
		Range: 1 to 65535		

**Table 9-4. Recorder-Reproducer Attributes Group (R)**

Parameter	Code Name	Usage Attributes	Definition	
RECORDING TECHNIQUE	R-x\TK2-n	Allowed when: R\N > 0	Specify the recording technique used for this track.	
		Range: Enumeration		
		Enumeration		Description
		FM/FM		Indirect FM
		HDDR		Hard Disk Recording
		PRE_D		Pre-detection
		DIRECT		Direct FM
		FMWBI		FM-Wide Band GRP I
		FMWBII		FM-Wide Band GRP II
		FM-IM		FM-Intermediate Band
		FM-NB		FM-Narrow Band
		DOUDEN		Double Density
		RO-K		(Rotary [Single Track])
		RO-MUX		(Rotary [Multiplexed])
SSR	Solid State			
OTHER	All other techniques			
INPUT STREAM DE- RANDOMIZATIO N	R-x\IDDR-n	Allowed when: R\N > 0	Specify how input stream is recorded. Stream is recorded after being derandomized. Stream is recorded as received. If PCM data type is not throughput and input data stream is randomized, this parameter must be "Y".	
		Range: Enumeration		
		Enumeration		Description
		Y		Yes
		N		No
Default: N				
DATA SOURCE ID	R-x\DSI-n	R/R Ch 10 Status: R	Specify the data source identification. For a site-recorded multiplexed track, provide a data source identification.	
		Allowed when: R\N > 0		
		Links from: G\DSI-n		
		Links to: M-x\ID		
		Required when: Allowed		
Range: 32 characters				
DATA DIRECTION	R-x\TK3-n	Allowed when: R\N > 0	Specify data direction.	

**Table 9-4. Recorder-Reproducer Attributes Group (R)**

Parameter	Code Name	Usage Attributes		Definition
		Range: Enumeration		
		Enumeration	Description	
		FWD	Forward	
		REV	Reverse	
		Default: FWD		
RECORDER PHYSICAL CHANNEL NUMBER	R-x\TK4-n	R/R Ch 10 Status: R		Specify the recorder physical channel for the channel ID (TK1).
		Allowed when: R\N > 0		
		Required when: Allowed		
		Range: 1 to 65535		
CHANNEL ENABLE	R-x\CHE-n	R/R Ch 10 Status: R		Indicate if source is enabled. Source must be enabled to generate data packets.
		Allowed when: R\N > 0		
		Required when: Allowed		
		Range: Enumeration		
		Enumeration	Description	
		T	True	
		F	False	
CHANNEL DATA TYPE	R-x\CDT-n	R/R Ch 10 Status: R		Specify the type of source if “STO” was specified in G group data source type.
		Allowed when: R\N > 0		
		Required when: Allowed		
		Range: Enumeration		
		Enumeration	Description	
		PCMIN	PCM Input	
		VIDIN	Video Input	
		ANAIN	Analog Input	
		1553IN	1553 Input	
		DISIN	Discrete Input	
		TIMEIN	IRIG Time Input	
		UARTIN	UART Input	
		429IN	ARINC 429 Input	

**Table 9-4. Recorder-Reproducer Attributes Group (R)**

Parameter	Code Name	Usage Attributes		Definition
		MSGIN	Message Data Input	
		IMGIN	Image Data Input	
		1394IN	IEEE-1394 Input	
		PARIN	Parallel Input	
		ETHIN	Ethernet Input	
		TSPIIN	TSPI/CTS Input	
		CANIN	CAN bus Input	
		FBCHIN	Fibre Channel Input	
		TMOUT	Telemetry Output	
CHANNEL DATA LINK NAME	R-x\CDLN-n	R/R Ch 10 Status: R		Identify the data link name consistent with the PCM format, bus data, or message data group for the channel.
		Allowed when: R\N > 0		
		Required when: A data link is associated with the channel.		
		Links to: P-d\DLN, B-x\DLN, S-d\DLN		
		Range: 32 characters		
SECONDARY HEADER TIME FORMAT	R-x\SHTF-n	R/R Ch 10 Status: RO		If enabled, the secondary header time format.
		Allowed when: R\N > 0		
		Range: Enumeration		
		Enumeration	Description	
		0	<a href="#">Chapter 4</a> BCD	
		1	IEEE-1588	
		2	ERTC	
<b>Data Type Attributes</b>				
<b>PCM Data Type Attributes</b>				
PCM DATA TYPE FORMAT	R-x\PDTF-n	R/R Ch 10 Status: RO		PCM data type format. Enumeration equates to format number in <a href="#">Chapter 11</a> .
		Allowed when: R\CDT is “PCMIN”		
		Required when: Allowed		
		Range: Enumeration		
		Enumeration	Description	

**Table 9-4. Recorder-Reproducer Attributes Group (R)**

Parameter	Code Name	Usage Attributes		Definition
		0	reserved	
		1	<a href="#">Chapter 4</a> , <a href="#">Chapter 7</a> , <a href="#">Chapter 8</a>	
		2	DQM/DQE	
DATA PACKING OPTION	R-x\PDP-n	R/R Ch 10 Status: RO		How data is placed in the packets.
		Allowed when: R\CDT is "PCMIN"		
		Required when: Allowed		
		Range: Enumeration		
		Enumeration	Description	
		UN	Unpacked	
		TM	Throughput mode	
PFS	Packed with frame sync			
RECORDER POLARITY SETTING	R-x\RPS-n	R/R Ch 10 Status: RO		Recorder Data polarity setting. Specify if the recorder is to invert the input stream before recording it.
		Allowed when: P-d\CDT is "PCMIN"		
		Range: Enumeration		
		Enumeration	Description	
		N	Normal – Do not invert data prior to recording	
		I	Invert data prior to recording	
Default: N				
INPUT CLOCK EDGE	R-x\ICE-n	R/R Ch 10 Status: RO		Specify the input clock edge relative to the data in degrees.
		Allowed when: R\CDT is "PCMIN"		
		Range: Enumeration		
		Enumeration	Description	
		0	0 degrees	
		180	180 degrees	
Default: 0				
INPUT SIGNAL TYPE	R-x\IST-n	R/R Ch 10 Status: RO		Type of input signal.
		Allowed when: R\CDT is "PCMIN"		

**Table 9-4. Recorder-Reproducer Attributes Group (R)**

Parameter	Code Name	Usage Attributes		Definition
		Range: Enumeration		
		Enumeration	Description	
		SE	Single ended	
		DIFF	Differential	
		RS422	RS-422 standard differential	
		TTL	Single ended with TTL	
		Default: DIFF		
INPUT THRESHOLD	R-x\ITH-n	R/R Ch 10 Status: RO		Specify the input threshold level for selectable electrical interface. The value is the threshold level in volts.
		Allowed when: R\CDT is "PCMIN"		
		Required when: Allowed		
		Range: Floating point -999.9 to 999.9		
INPUT TERMINATION	R-x\ITM-n	R/R Ch 10 Status: RO		Specify the input termination.
		Allowed when: R\CDT is "PCMIN"		
		Range: Enumeration		
		Enumeration	Description	
		LOW-Z	Low impedance	
		HIGH-Z	High impedance	
PCM VIDEO TYPE FORMAT	R-x\PTF-n	R/R Ch 10 Status: RO		Compression technique for video recorded as standard <a href="#">Chapter 4</a> PCM. The compressed data is encapsulated in ISO Standard Transport Stream (TS) frames. If type format is "OTHER", then a vendor spec is required to identify the data compression technique. Specify "NONE" if data is not video data.
		Allowed when: R\CDT is "PCMIN"		
		Range: Enumeration		
		Enumeration	Description	
		NONE	Not video	
		MPEG1	MPEG1 Compression	
		MPEG2	MPEG2 Compression	
		H261	H.261 Compression	
		WAVE	Wavelet Compression	
		OTHER	Other Compression (including uncompressed)	



**Table 9-4. Recorder-Reproducer Attributes Group (R)**

Parameter	Code Name	Usage Attributes		Definition
		Default: NONE		
PCM RECORDER-REPRODUCER MINOR FRAME FILTERING ENABLED	R-x\MFF\E-n	R/R Ch 10 Status: RO		Indicate if recorder-reproducer minor frame filtering is enabled for the PCM channel (not applicable for throughput mode PCM channels).
		Allowed when: R\PDP = "PFS" or "UN"		
		Range: Enumeration		
		Enumeration	Description	
		T	True	
		F	False	
PCM POST-PROCESS OVERWRITE AND FILTERING ENABLED	R-x\POF\E-n	R/R Ch 10 Status: RO		Indicate if post-process overwrite and filtering is enabled for the PCM channel.
		Allowed when: R\PDP = "PFS" or "UN"		
		Range: Enumeration		
		Enumeration	Description	
		T	True	
		F	False	
PCM POST-PROCESS OVERWRITE AND FILTERING TYPE	R-x\POF\T-n	R/R Ch 10 Status: RO		Indicate the type of post-process overwrite and filtering for the PCM channel.
		Allowed when: R\POF\E = "T"		
		Range: Enumeration		
		Enumeration	Description	
		MF	Minor frame	
		SM	Selected measurement	
B	Both			
MINOR FRAME FILTERING DEFINITION TYPE	R-x\MFF\FDT-n	R/R Ch 10 Status: RO-PAK		Specify the PCM minor frame filtering definition type.
		Allowed when: R\POF\T is "B" or "MF" or R\MFF\E is "T"		
		Range: Enumeration		
		Enumeration	Description	
		IN	Inclusive filtering	
		EX	Exclusive filtering	

**Table 9-4. Recorder-Reproducer Attributes Group (R)**

Parameter	Code Name	Usage Attributes	Definition
NUMBER OF MINOR FRAME FILTERING DEFINITIONS	R-x\MFF\N-n	R/R Ch 10 Status: RO-PAK	Specify the number of PCM minor frame filtering definitions.
		Allowed when: R\POF\T is “B” or “MF” or R\MFF\E is “T”	
		Range: 0 to 999	
FILTERED MINOR FRAME NUMBER	R-x\MFF\MFN-n-m	R/R Ch 10 Status: RO-PAK	Specify the PCM minor frame number to be filtered.
		Allowed when: R\MFF\N > 0	
		Required when: Allowed Range: 0 to 999	
RECORDER POLARITY SETTING	R-x\MFF\RPS-n-m	R/R Ch 10 Status: RO	Recorder Data polarity setting  Note. The recorder is to invert the input stream before recording it.
		Allowed when: When P-d\CDT is “PCMIN”	
		Range: Enumeration	
		Enumeration Description	
		N Normal I Inverted Default: N	
<b>NOTE:</b> For PCM formats with multiple subframe ID counters, all minor frame numbers defined for filtering are associated with the first subframe ID counter.			
NUMBER OF SELECTED MEASUREMENT OVERWRITE DEFINITIONS	R-x\SMF\N-n	R/R Ch 10 Status: RO	Specify the number of PCM selected measurement overwrite definitions.
		Allowed when: R\POF\T is “B” or “SM” or R\MFF\E is “T”	
		Range: 0 to 99	
SELECTED MEASUREMENT NAME	R-x\SMF\SMN-n-m	R/R Ch 10 Status: RO	Specify the PCM selected measurement name to be overwritten.
		Allowed when: R\SMF\N > 0	
		Required when: Allowed	
		Links to: D-x\MN-y-n Range: 32 characters	
MEASUREMENT OVERWRITE TAG	R-x\SMF\MFOT-n-m	R/R Ch 10 Status: RO	Indicate if the PCM measurement is tagged for overwriting.
		Allowed when: R\SMF\N > 0	

**Table 9-4. Recorder-Reproducer Attributes Group (R)**

Parameter	Code Name	Usage Attributes	Definition	
		Range: Enumeration		
		Enumeration	Description	
		O	Overwrite	
		N	No overwriting	
		Default: N		
<b>MIL-STD-1553 Bus Data Type Attributes</b>				
MIL-STD-1553 BUS DATA TYPE FORMAT	R-x\BTF-n	R/R Ch 10 Status: RO	MIL-STD-1553 bus data type format. Enumeration equates to format number in <a href="#">Chapter 10</a> .	
		Allowed when: R\CDT is “1553IN”		
		Required when: Allowed		
		Range: Enumeration		
		Enumeration		Description
		0		reserved
		1		MIL-STD-1553B data
		2	16PP194 bus	
MIL-STD-1553 RECORDER- REPRODUCER FILTERING ENABLED	R-x\MRF\E-n	R/R Ch 10 Status: RO	Indicate if recorder-reproducer filtering is enabled for the MIL-STD-1553 channel.	
		Allowed when: R\CDT is “1553IN”		
		Range: Enumeration		
		Enumeration		Description
		T		True
		F	False	
MIL-STD-1553 POST-PROCESS OVERWRITE AND FILTERING ENABLED	R-x\MOF\T-n	R/R Ch 10 Status: RO	Indicate if post-process overwrite and filtering is enabled for the MIL-STD-1553 channel.	
		Allowed when: R\CDT is “1553IN”		
		Range: Enumeration		
		Enumeration		Description
		T		True
		F	False	
MIL-STD-1553 MESSAGE	R-x\MFD\FDT-n	Allowed when: R\MRF\E or R\MOF\T is “T”	Specify the message filtering definition type.	
		Required when: Allowed		

**Table 9-4. Recorder-Reproducer Attributes Group (R)**

Parameter	Code Name	Usage Attributes		Definition
FILTERING DEFINITION TYPE		Range: Enumeration		
		Enumeration	Description	
		IN	Inclusive filtering	
		EX	Exclusive filtering	
NUMBER OF MESSAGE FILTERING DEFINITIONS	R-x\MFD\N-n	Allowed when: R\MRF\E or R\MOF\T is "T"		Specify the number of message filtering definitions.
		Required when: Allowed		
		Range: 0 to 99		
MESSAGE NUMBER	R-x\MFD\MID-n-m	Allowed when: R\MFD\N > 0		Specify the message number to be filtered and overwritten.
		Required when: Allowed		
		Range: 1 to 999999999		
MESSAGE TYPE	R-x\MFD\MT-n-m	Allowed when: R\MFD\N > 0		Specify the message type.
		Required when: Allowed		
		Range: Enumeration		
		Enumeration	Description	
		RTRT	RT/RT	
		RTBC	RT/BC	
		BCRT	BC/RT	
		MC	Mode code	
COMMAND WORD ENTRY	R-x\CWE-n-m	Allowed when: R\MFD\N > 0		Method used to specify the command word.
		Range: Enumeration		
		Enumeration	Description	
		W	Enter the entire command word in the "COMMAND WORD" attribute.	

**Table 9-4. Recorder-Reproducer Attributes Group (R)**

Parameter	Code Name	Usage Attributes		Definition
		F	Enter the command word fields separately in the “REMOTE TERMINAL ADDRESS”, “SUBTERMINAL ADDRESS”, “TRANSMIT/RECEIVE MODE”, and “DATA WORD COUNT/MODE CODE” attributes.	
		Default: F		
COMMAND WORD	R-x\CMD-n-m	Allowed when: R\MFD\N > 0		Specify the entire command word for this message.
		Required when: R\CWE is “W”		
		Range: Hexadecimal, 0000-FFFF		
REMOTE TERMINAL ADDRESS	R-x\MFD\TRA-n-m	Allowed when: R\MFD\N > 0		Specify the five-bit remote terminal address for this message. Use “X” to indicate a “don’t care” value.
		Required when: R\CWE is “F”		
		Range: Binary 00000-11111		
TRANSMIT/RECEIVE MODE	R-x\MFD\TRM-n-m	Allowed when: R\MFD\N > 0		Indicate if this command word is a transmit or receive command. For RT/RT, specify transmit.
		Required when: R\CWE is “F”		
		Range: Enumeration		
		Enumeration	Description	
		1	Transmit	
0	Receive			
SUBTERMINAL ADDRESS	R-x\MFD\STA-n-m	Allowed when: R\MFD\N > 0		Specify the five-bit subterminal address for this message. Use “X” to indicate a “don’t care” value.
		Required when: R\CWE is “F”		
		Range: Binary 00000-11111		
DATA WORD COUNT/MODE CODE	R-x\MFD\DWC-n-m	Allowed when: R\MFD\N > 0		Enter the number of data words as a binary string, using “X” to indicate a “don’t care” value. If the subterminal address indicates a mode code, enter the mode code value as a binary string.
		Required when: R\CWE is “F”		
		Range: Binary 00000-11111		

**Table 9-4. Recorder-Reproducer Attributes Group (R)**

Parameter	Code Name	Usage Attributes		Definition
RECEIVE COMMAND WORD ENTRY	R-x\RCWE-n-m	Allowed when: R\MFD\N > 0		Method used to specify the receive command word.
		Range: Enumeration		
		Enumeration	Description	
		W	Enter the entire command word in the “RECEIVE COMMAND WORD” attribute.	
		F	Enter the command word fields separately in the “RT/RT REMOTE TERMINAL ADDRESS”, “RT/RT SUBTERMINAL ADDRESS”, and “RT/RT DATA WORD COUNT” attributes.	
Default: F				
RECEIVE COMMAND WORD	R-x\RCMD-n-m	Allowed when: R\MFD\N > 0		Specify the entire receive command word for this RT/RT message.
		Required when: R\RCWE is “W”		
		Range: Hexadecimal, 0000-FFFF		
RT/RT REMOTE TERMINAL ADDRESS	R-x\MFD\RTRA-n-m	Allowed when: R\MFD\N > 0		Specify the five-bit remote terminal address for this RT/RT message. Use “X” to indicate a “don’t care” value.
		Required when: R\RCWE is “F”		
		Range: Binary, 00000 - 11111		
RT/RT SUBTERMINAL ADDRESS	R-x\MFD\RSTA-n-m	Allowed when: R\MFD\N > 0		Specify the five-bit subterminal address for this RT/RT message. Use “X” to indicate a “don’t care” value.
		Required when: R\RCWE is “F”		
		Range: Binary 00000 - 11111		
RT/RT DATA WORD COUNT	R-x\MFD\RDWC-n-m	Allowed when: R\MFD\N > 0		Enter the number of data words as a binary string, using “X” to indicate a “don’t care” value. Exclude status and time words (an RT/RT message cannot contain a mode code).
		Required when: R\RCWE is “F”		
		Range: Binary 00000 - 11111		
NUMBER OF SELECTED	R-x\BME\N-n	R/R Ch 10 Status: RO		Specify the number of bus measurement overwrite definitions.
		Allowed when: R\MRF\E or R\MOF\T is “T”		

**Table 9-4. Recorder-Reproducer Attributes Group (R)**

Parameter	Code Name	Usage Attributes	Definition	
MEASUREMENT OVERWRITE DEFINITIONS		Range: 0 to 99		
SELECTED MEASUREMENT NAME	R-x\BME\SMN-n-m	R/R Ch 10 Status: RO	Specify the bus measurement name to be overwritten.	
		Allowed when: R\BME\N > 0		
		Required when: Allowed		
		Links to: B-x\MN-i-n-p		
		Range: 32 characters		
MEASUREMENT OVERWRITE TAG	R-x\BME\MFOT-n-m	R/R Ch 10 Status: RO	Indicate if the bus measurement is tagged for overwriting.	
		Allowed when: R\BME\N > 0		
		Range: Enumeration		
		Enumeration		Description
		O		Overwrite
		N		No overwriting
		Default: N		
<b>Analog Data Type Attributes</b>				
ANALOG DATA TYPE FORMAT	R-x\ATF-n	R/R Ch 10 Status: RO	Analog data type format. Enumeration equates to format number in <a href="#">Chapter 11</a> .	
		Allowed when: R\CDT is "ANAIN"		
		Required when: Allowed		
		Range: Enumeration		
		Enumeration		Description
		0		Reserved
		1		Analog data, Format 1
2	Analog data, Format 2			
		3	Analog data, Format 3	
NUMBER OF ANALOG CHANNELS/PKT	R-x\ACH\N-n	R/R Ch 10 Status: RO	Specify the number of analog channels per packet.	
		Allowed when: R\CDT is "ANAIN"		
		Required when: Allowed		
		Range: 1 to 256		



**Table 9-4. Recorder-Reproducer Attributes Group (R)**

Parameter	Code Name	Usage Attributes	Definition	
DATA PACKING OPTION	R-x\ADP-n	R/R Ch 10 Status: RO	How data is placed in the packets.	
		Allowed when: R\CDT is “ANAIN”		
		Range: Enumeration		
		Enumeration		Description
		YES		Packed
		NO		Unpacked
		Default: YES		
SAMPLE RATE	R-x\ASR-n	R/R Ch 10 Status: RO	Sample rate of the fastest channel(s) in samples per second.	
		Allowed when: R\CDT is “ANAIN”		
		Required when: Allowed		
		Range: positive floating point		
SUB CHANNEL ENABLED	R-x\AMCE-n-m	R/R Ch 10 Status: R	Indicate if sub-channel is enabled.	
		Allowed when: R\CDT is “ANAIN”		
		Range: Enumeration		
		Enumeration		Description
		T		True
		F		False
SUB CHANNEL NUMBER	R-x\AMCN-n-m	R/R Ch 10 Status: R	Indicate the analog sub channel number associated with the -n-m sub channel. First subchannel is 1.	
		Allowed when: R\CDT is “ANAIN”		
		Required when: Allowed		
		Range: 1 to 256		
MEASUREMENT NAME	R-x\AMN-n-m	R/R Ch 10 Status: RO	Identify the measurement name consistent with the Data Conversion group for an analog channel.	
		Allowed when: R\CDT is “ANAIN”		
		Required when: R-x\ACH\N > 1		
		Links to: C-d\DCN		
		Range: 32 characters		
DATA LENGTH	R-x\ADL-n-m	R/R Ch 10 Status: RO	Number of bits per data word.	
		Allowed when: R\CDT is “ANAIN”		



**Table 9-4. Recorder-Reproducer Attributes Group (R)**

Parameter	Code Name	Usage Attributes		Definition
		Required when: Allowed		
		Range: 1 to 64		
BIT MASK	R-x\AMSK-n-m	R/R Ch 10 Status: RO		Binary string of 1s and 0s to identify the bits in a word location that are assigned to this measurement. If the full word is used for this measurement, enter "FW." Left-most bit corresponds to the msb.
		Allowed when: R\CDT is "ANAIN"		
		Range: Binary, maximum 64 characters or "FW"		
		Default: FW		
MEASUREMENT TRANSFER ORDER	R-x\AMTO-n-m	R/R Ch 10 Status: RO		Define the first bit transferred in normal time sequence.
		Allowed when: R\CDT is "ANAIN"		
		Range: Enumeration		
		Enumeration	Description	
		M	msb first	
		L	lsb first	
		D	msb first	
Default: M				
SAMPLE FACTOR	R-x\ASF-n-m	R/R Ch 10 Status: RO		1/(2 <sup>n</sup> ) times the fastest sample rate (defined above) gives the sample rate for this channel. Specify the value "n" in this field.
		Allowed when: R\CDT is "ANAIN"		
		Required when: Allowed		
		Range: 0 to 63		
SAMPLE FILTER 3DB BANDWIDTH	R-x\ASBW-n-m	R/R Ch 10 Status: RO		Sample filter in units of Hz.
		Allowed when: R\CDT is "ANAIN"		
		Required when: Allowed		
		Range: positive floating point		
AC/DC COUPLING	R-x\ACP-n-m	R/R Ch 10 Status: RO		Analog signal coupling.
		Allowed when: R\CDT is "ANAIN"		
		Required when: Allowed		
		Range: Enumeration		
		Enumeration	Description	
		A	AC Coupled	

**Table 9-4. Recorder-Reproducer Attributes Group (R)**

Parameter	Code Name	Usage Attributes		Definition	
		D	DC Coupled		
RECORDER INPUT IMPEDANCE	R-x\AII-n-m	R/R Ch 10 Status: RO		Analog signal input impedance to the recorder. Units of ohms.	
		Allowed when: R\CDT is "ANAIN"			
		Required when: Allowed			
		Range: positive floating point			
INPUT CHANNEL GAIN	R-x\AGI-n-m	R/R Ch 10 Status: RO		Signal gain of analog signal. Milli units (10x = 010000).	
		Allowed when: R\CDT is "ANAIN"			
		Required when: Allowed			
		Range: positive floating point			
INPUT FULL SCALE RANGE	R-x\AFSI-n-m	R/R Ch 10 Status: RO		Full-scale range of input signal. Units of millivolts (20vpp = 020000) (vpp = 2xvp).	
		Allowed when: R\CDT is "ANAIN"			
		Required when: Allowed			
		Range: positive floating point			
INPUT OFFSET VOLTAGE	R-x\AOVI-n-m	R/R Ch 10 Status: RO		Offset voltage of input signal. Units of millivolts (10v=010000).	
		Allowed when: R\CDT is "ANAIN"			
		Required when: Allowed			
		Range: positive floating point			
RECORDED ANALOG FORMAT	R-x\AF-n-m	R/R Ch 10 Status: RO		Format of input signal.	
		Allowed when: R\CDT is "ANAIN"			
		Required when: Allowed			
		Range: Enumeration			
		Enumeration	Description		
		1	One's complement		
		2	Two's complement		
		3	(Sign and magnitude binary [+ = 0])		
		4	(Sign and magnitude binary [+ = 1])		
B	Offset binary				



**Table 9-4. Recorder-Reproducer Attributes Group (R)**

Parameter	Code Name	Usage Attributes		Definition
		U	Unsigned binary	
		F	(IEEE 754 single-precision [IEEE 32] floating point)	
INPUT TYPE	R-x\AIT-n-m	R/R Ch 10 Status: RO		Type of input signal.
		Allowed when: R\CDT is “ANAIN”		
		Required when: Allowed		
		Range: Enumeration		
		Enumeration	Description	
		S	Single-ended	
		D	Differential	
AUDIO	R-x\AV-n-m	R/R Ch 10 Status: RO		Indicate if input signal is audio.
		Allowed when: R\CDT is “ANAIN”		
		Required when: Allowed		
		Range: Enumeration		
		Enumeration	Description	
		Y	Audio present	
		N	Audio not present	
AUDIO FORMAT	R-x\AVF-n-m	R/R Ch 10 Status: RO		Format of audio if present.
		Allowed when: R\AV is “Y”		
		Required when: Allowed		
		Range: Enumeration		
		Enumeration	Description	
		RAW	Raw, headerless PCM	
		WAV	Waveform Audio	
		LPCM	Linear PCM	
		AC3	Dolby AC-3	
		PRED	“PRED” format	
PSTD	“PSTD” format			



**Table 9-4. Recorder-Reproducer Attributes Group (R)**

<b>Table 9-4. Recorder-Reproducer Attributes Group (R)</b>				
<b>Parameter</b>	<b>Code Name</b>	<b>Usage Attributes</b>		<b>Definition</b>
		CVSD	Continuously Variable Slope Delta modulation	
		O	Other	
<b>Discrete Data Type Attributes</b>				
DISCRETE DATA TYPE FORMAT	R-x\DTF-n	R/R Ch 10 Status: RO		Discrete data type format. Enumeration equates to format number in <a href="#">Chapter 10</a> .
		Allowed when: R\CDT is “DISIN”		
		Required when: Allowed		
		Range: Enumeration		
		Enumeration	Description	
		0	Reserved	
1	Discrete data			
DISCRETE MODE	R-x\DMOD-n	R/R Ch 10 Status: RO		Indicate the mode whereby discrete events are placed in the packets.
		Allowed when: R\CDT is “DISIN”		
		Required when: Allowed		
		Range: Enumeration		
		Enumeration	Description	
		EV	Event mode	
SAMP	Sample mode			
SAMPLE RATE	R-x\DSR-n	R/R Ch 10 Status: RO		Sample rate in samples per second.
		Allowed when: R\CDT is “DISIN”		
		Required when: Allowed		
		Range: positive floating point		
NUMBER OF DISCRETE MEASUREMENTS	R-x\NDM\N-n	R/R Ch 10 Status: RO		Specify the number of discrete measurements.
		Allowed when: R\CDT is “DISIN”		
		Required when: Allowed		
		Range: 0 to 999		
MEASUREMENT NAME	R-x\DMN-n-m	R/R Ch 10 Status: RO		Identify the measurement name consistent with the data conversion group for one or more discrete bits.
		Allowed when: R\NDM\N > 0		
		Required when: Allowed		



**Table 9-4. Recorder-Reproducer Attributes Group (R)**

Parameter	Code Name	Usage Attributes	Definition								
		Links to: C-d\DCN Range: 32 characters									
BIT MASK	R-x\DMSK-n-m	R/R Ch 10 Status: RO Allowed when: R\NDM\N > 0 Required when: Allowed Range: Binary, max 32 characters or “FW”	Binary string of 1s and 0s to identify the bits in a word location that are assigned to this measurement. If the full word is used for this measurement, enter “FW”. Left-most bit corresponds to the msb.								
MEASUREMENT TRANSFER ORDER	R-x\DMTO-n-m	R/R Ch 10 Status: RO Allowed when: R\NDM\N > 0 Range: Enumeration <table border="1"> <thead> <tr> <th>Enumeration</th> <th>Description</th> </tr> </thead> <tbody> <tr> <td>M</td> <td>msb first</td> </tr> <tr> <td>L</td> <td>lsb first</td> </tr> <tr> <td>D</td> <td>msb first</td> </tr> </tbody> </table> Default: M	Enumeration	Description	M	msb first	L	lsb first	D	msb first	Shows msbs and least significant bits (lsbs).
Enumeration	Description										
M	msb first										
L	lsb first										
D	msb first										
ANALOG CENTER FREQUENCY 	R-x\ACF-n	R/R Ch 10 Status: R Allowed when: R\CDT is “ANAIN” and R\ATF is “2” or “3” Required when: Allowed Range: 6 characters Default: 0000.0	Documents the RF center frequency for the recorded Analog Data Type format 2 or 3. The value is specified as XXXX.Y MHz. A value of 0000.0 is equivalent to unknown.								
ANALOG IF FREQUENCY 	R-x\AIF-n	R/R CH Status: R Allowed when: R\CDT is “ANAIN” AND R\ATF is “2” or “3” Required when: Allowed Range: 5 characters Default: 070.0	Documents the Intermediate Frequency (IF) value for Analog Data Type format 2 or 3. The original RF signal has been downconverted and centered at this IF. The value is specified as XXX.Y MHz. This is typically a value of 70.0 MHz.								





**Table 9-4. Recorder-Reproducer Attributes Group (R)**

Parameter	Code Name	Usage Attributes	Definition	
<b>ARINC 429 Bus Data Type Attributes</b>				
ARINC 429 BUS DATA TYPE FORMAT	R-x\ABTF-n	R/R Ch 10 Status: RO	ARINC 429 bus data type format. Enumeration equates to format number in <a href="#">Chapter 10</a> .	
		Allowed when: R\CDT is “429IN”		
		Required when: Allowed		
		Range: Enumeration		
		Enumeration		Description
		0		ARINC 429 data
		1		Reserved
NUMBER OF ARINC 429 BUSSES	R-x\NAS\N-n 	R/R Ch 10 Status: RO	ARINC 429 bus number, First bus is 1.	
		Allowed when: R\CDT is “429IN”		
		Required when: Allowed		
		Range: 1 to 256		
ARINC 429 BUSSES	R-x\ASN-n-m 	R/R Ch 10 Status: RO	ARINC 429 bus number. First bus is 1.	
		Allowed when: R\NAS\N > 0		
		Required when: Allowed		
		Range: 1 to 256.		
ARINC 429 SUB-CHANNEL NAME	R-x\ANM-n-m	R/R Ch 10 Status: RO	ARINC 429 bus sub-channel name.	
		Allowed when: R\NAS\N > 0		
		Required when: Allowed		
		Range: 32 characters		
<b>Video Data Type Attributes</b>				
VIDEO DATA TYPE FORMAT	R-x\VTF-n	R/R Ch 10 Status: RO	Video data type format. Enumeration equates to format number in <a href="#">Chapter 10</a> .	
		Allowed when: R\CDT is “VIDIN”		
		Required when: Allowed		
		Range: Enumeration		
		Enumeration		Description
		0		MPEG-2/H.264
		1		MPEG-2 ISO 13818

**Table 9-4. Recorder-Reproducer Attributes Group (R)**

Parameter	Code Name	Usage Attributes		Definition
		2	MPEG-4 ISO 14496	
VIDEO MPEG-2 TRANSPORT STREAM PRIMARY CODEC	R-x\VXF-n	Allowed when: R\CDT is "VIDIN"		Type of CODEC used in Transport Stream (Xon2): "0" (MPEG 2/H.262), "1" (MPEG-4 Part 7 AVC/H.264), "2" (MPEG-H Part 2 HEVC/H.265), "4" (Motion JPEG 2000, ISO/IEC 15444-3:2002)
		Required when: Allowed		
		Range: Enumeration		
		Enumeration	Description	
		0	MPEG-2/H.262	
		1	MPEG-4 Part 7 AVC/H.264	
		2	MPEG-H Part 2 HEVC/H.265	
4	MJPEG 2000			
VIDEO FRAME DESCRIPTION	R-x\VFD-n 	Allowed when: R\CDT is "VIDIN"		Frame description in the form <i>width x height Scan Framerate</i> , where "Scan" is "p" or "i" for progressive/interlaced, and the width and height are in pixels (e.g. 1280x720p59.94 and 720x480i50). <b>This is INFORMATIONAL ONLY.</b>
		Required when: Allowed		
		Range: 40 characters		
VIDEO CODEC INFORMATION	R-x\VCI-n 	Allowed when: R\CDT is "VIDIN"		Information about the level/profile of the encoder (e.g. "MPEG-2 MP@HL" or "H.265 L4")
		Required when: Allowed		
		Range: 16 characters		
VIDEO AUDIO CHANNELS	R-x\VAC-n 	Allowed when: R\CDT is "VIDIN"		Number of audio channels included with the video stream
		Required when: Allowed		
		Range: positive floating point		

**Table 9-4. Recorder-Reproducer Attributes Group (R)**

Parameter	Code Name	Usage Attributes		Definition
VIDEO AUDIO ENCODING	R-x\VAA-n 	Allowed when: R-x\VAC > 0		Audio encoding type as per MISB ST 1001.
		Required when: Allowed		
		Range: enumeration		
		Enumeration	Description	
		0	Auto detect	
		1	MPEG-1 Layer 2	
		2	MPEG-2 Layer 2	
VIDEO METADATA PRESENCE	R-x\VMD-n 	Allowed when: R\CDT is "VIDIN"		Whether metadata is expected and whether it is KLV or otherwise encoded
		Required when: Allowed		
		Range: enumeration		
		Enumeration	Description	
		N	No metadata expected	
		K	KLV metadata expected	
VIDEO METADATA TYPE	R-x\VMT-n 	Allowed when: R-x\VMD is not "N"		String identifying controlling standard, e.g. "MISB ST 0601 / SMPTE RP 210"
		Required when: Allowed		
		Range: 32 characters		
VIDEO SIGNAL TYPE	R-x\VST-n	Allowed when: R\CDT is "VIDIN"		The video signal input type. 
		Required when: Allowed		
		Range: Enumeration		
		Enumeration	Description	
		0	Auto detect/Other	
		1	Composite	
		2	YUV	
		3	S-VIDEO	
4	DVI			
5	RGB			



**Table 9-4. Recorder-Reproducer Attributes Group (R)**

Parameter	Code Name	Usage Attributes		Definition
		6	SDI	
		7	VGA	
VIDEO SIGNAL FORMAT TYPE	R-x\VSF-n	R/R Ch 10 Status: RO		The video signal input type.
		Allowed when: R\CDT is "VIDIN"		
		Required when: Allowed		
		Range: Enumeration		
		Enumeration	Description	
		0	Auto detect	
		1	NTSC	
		2	PAL	
		3	ATSC	
		4	DVB	
		5	ISDB	
		6	SECAM	
VIDEO CONSTANT BIT RATE	R-x\CBR-n	Allowed when: R\CDT is "VIDIN"		Contains aggregate stream bit rate in bits per second.
		Required when: Allowed		
		Range: positive floating point		
VIDEO VARIABLE PEAK BIT RATE	R-x\VBR-n	Allowed when: R\CDT is "VIDIN"		Contains peak stream bit rate in bits per second.
		Required when: Allowed		
		Range: positive floating point		
VIDEO ENCODING DELAY	R-x\VED-n	Allowed when: R\CDT is "VIDIN"		Delay introduced by video encoding hardware in milliseconds.
		Required when: Allowed		
		Range: positive floating point		
OVERLAY ENABLED	R-x\VCO\OE-n	Allowed when: R\CDT is "VIDIN"		Indicate if overlay is enabled.
		Required when: Allowed		
		Range: Enumeration		
		Enumeration	Description	
		T	True	
F	False			

**Table 9-4. Recorder-Reproducer Attributes Group (R)**

Parameter	Code Name	Usage Attributes		Definition
OVERLAY X POSITION	R-x\VCO\X-n	Allowed when: R\VCO\OE is "T"		Specify the X pixel position of the overlay in the video channel. Zero indicates the leftmost position of the video image.
		Required when: Allowed		
		Range: 0 to 99999		
OVERLAY Y POSITION	R-x\VCO\Y-n	Allowed when: R\VCO\OE is "T"		Specify the Y line position of the overlay in the video channel. Zero indicates the uppermost position of the video image.
		Required when: Allowed		
		Range: 0 to 99999		
OVERLAY EVENT TOGGLE ENABLED	R-x\VCO\OET-n	Allowed when: R\VCO\OE is "T"		Indicate if overlay event toggle is enabled.
		Required when: Allowed		
		Range: Enumeration		
		Enumeration	Description	
		T	True	
		F	False	
OVERLAY FORMAT	R-x\VCO\OLF-n	Allowed when: R\VCO\OE is "T"		Indicate format of the time overlay.
		Required when: Allowed		
		Range: Enumeration		
		Enumeration	Description	
		DT	Day and time (DDD:HH:MM:SS)	
		TO	Time only (HH:MM:SS)	
		TM	Time and milliseconds (HH:MM:SS:SSS)	
		DTM	Day, time, and milliseconds (DDD:HH:MM:SS:SSS)	
OVERLAY BACKGROUND	R-x\VCO\OBG-n	Allowed when: R\VCO\OE is "T"		Indicate background of the time overlay.
		Required when: Allowed		
		Range: Enumeration		
		Enumeration	Description	
		BOT	Black on transparent	
		WOT	White on transparent	

**Table 9-4. Recorder-Reproducer Attributes Group (R)**

Parameter	Code Name	Usage Attributes		Definition
		BOW	Black on white	
		WOB	White on black	
ANALOG AUDIO CHANNEL INPUT LEFT	R-x\ASI\ASL-n	Allowed when: R\CDT is "VIDIN"		Indicate the analog channel source of the left audio channel ID for the video channel.
		Range: 1 to 65536		
ANALOG AUDIO CHANNEL INPUT RIGHT	R-x\ASI\ASR-n	Allowed when: R\CDT is "VIDIN"		Indicate the analog channel source of the right audio channel ID for the video channel.
		Range: 1 to 65536		
VIDEO DATA ALIGNMENT	R-x\VDA-n	Allowed when: R\CDT is "VIDIN"		Specify the data alignment of the video data within the packet. <b>Note that the use of Little endian MPEG packets is contrary to the controlling standard.</b>
		Required when: Allowed		
		Range: Enumeration		
		Enumeration	Description	
		L	Little endian	
		B	Big endian	
<b>Time Data Type Attributes</b>				
TIME DATA TYPE FORMAT	R-x\TTF-n	R/R Ch 10 Status: R		Time data type format. Enumeration equates to format number in <a href="#">Chapter 10</a> .
		Allowed when: R\CDT is "TIMEIN"		
		Required when: Allowed		
		Range: Enumeration		
		Enumeration	Description	
		0	Reserved	
		1	Time data	
2	Network time			
TIME FORMAT	R-x\TFMT-n	R/R Ch 10 Status: R		
		Allowed when: R\CDT is "TIMEIN"		
		Range: Enumeration		
		Enumeration	Description	
		A	IRIG-A 1xy	



**Table 9-4. Recorder-Reproducer Attributes Group (R)**

Table 9-4. Recorder-Reproducer Attributes Group (R)				
Parameter	Code Name	Usage Attributes		Definition
		B	IRIG-B 1xy	Indicate the format for the time. For additional information, see RCC 200-16. <sup>1</sup> y is an optional last digit.
		G	IRIG-G 1xy	
		I	Internal	
		N	Native GPS time	
		U	UTC time from GPS	
		X	None	
		0	Network Time Protocol Version 3 RFC-1305	
		1	IEEE Std 1588-2002	
		2	IEEE Std 1588-2008	
		Default: A		
TIME SOURCE	R-x\TSRC-n	R/R Ch 10 Status: R		Indicate the time source.
		Allowed when: R\CDT is "TIMEIN"		
		Required when: Allowed		
		Range: Enumeration		
		Enumeration	Description	
		I	Internal	
		E	External	
		R	Internal from RMM	
X	None			
<b>Image Data Type Attributes</b>				
IMAGE DATA TYPE FORMAT	R-x\ITF-n	R/R Ch 10 Status: RO		Image data type format. Enumeration equates to format number in <a href="#">Chapter 10</a> .
		Allowed when: R\CDT is "IMGIN"		
		Required when: Allowed		
		Range: Enumeration		
		Enumeration	Description	

<sup>1</sup> Range Commanders Council. *IRIG Serial Time Code Formats*. RCC 200-16. August 2016. May be superseded by update. Retrieved 17 May 2021. Available at <https://www.trmc.osd.mil/wiki/x/wou8Bg>.

**Table 9-4. Recorder-Reproducer Attributes Group (R)**

Parameter	Code Name	Usage Attributes		Definition
		0	Image	
		1	Still imagery	
		2	Dynamic imagery	
STILL IMAGE TYPE	R-x\SIT-n	R/R Ch 10 Status: RO		Type of still imagery format.
		Allowed when: R\CDT is "IMGIN"		
		Required when: Allowed		
		Range: Enumeration		
		Enumeration	Description	
		0	NITF	
		1	JPEG	
		2	JPEG2	
DYNAMIC IMAGE FORMAT	R-x\DIF-n	R/R Ch 10 Status: RO		Type of dynamic imagery format IAW Genicam standard features naming convention v1.5 or later and GigE Vision v1.2 or later.
		Allowed when: R\CDT is "IMGIN"		
		Required when: Allowed		
		Range: Enumeration		
		(Permitted enumerated values are per standards referenced in the Definition column or the word DEVICESPECIFIC for any imagery format not referenced by those standards.)		
IMAGE TIME STAMP MODE	R-x\ITSM-n	R/R Ch 10 Status: RO		Individual image time stamp mode.
		Allowed when: R\CDT is "IMGIN"		
		Required when: Allowed		
		Range: Enumeration		
		Enumeration	Description	
		0	Image capture time	
		1	Image packetization time	

**Table 9-4. Recorder-Reproducer Attributes Group (R)**

Parameter	Code Name	Usage Attributes	Definition	
DYNAMIC IMAGE ACQUISITION MODE	R-x\DIAM-n	R/R Ch 10 Status: RO	Dynamic image acquisition mode. “0” (Single frame). “1” (Multi-frame). “2” (Continuous).	
		Allowed when: R\CDT is “IMGIN”		
IMAGE FRAME RATE	R-x\IFR-n	R/R Ch 10 Status: RO	Frame rate in frames per second at which the frames are captured or streamed in continuous mode.	
		Required when: Allowed		
		Range: positive floating point		
PRE-TRIGGER FRAMES	R-x\PTG-n	Allowed when: R\CDT is “IMGIN”	Number of frames to capture before acquisition trigger.	
		Range: positive floating point		
TOTAL FRAMES	R-x\TOTF-n	Allowed when: R\CDT is “IMGIN”	Total number of frames to be captured including pre-trigger frames.	
		Range: positive floating point		
EXPOSURE TIME	R-x\EXP-n	Allowed when: R\CDT is “IMGIN”	Image exposure time in microseconds including fractional seconds if desired.	
		Range: positive floating point		
SENSOR ROTATION	R-x\ROT-n	Allowed when: R\CDT is “IMGIN”	Sensor rotation 0-359.	
		Range: 0 to 359		
SENSOR GAIN VALUE	R-x\SGV-n	Allowed when: R\CDT is “IMGIN”	Sensor gain value in dB.	
		Range: floating point		
SENSOR AUTO GAIN	R-x\SAG-n	Allowed when: R\CDT is “IMGIN”	Sensor auto gain.	
		Range: Enumeration		
		Enumeration		Description
		0		Off
		1		On
SENSOR WIDTH	R-x\ISW-n	R/R Ch 10 Status: RO	Effective sensor width in pixels used to capture images.	
		Allowed when: R\CDT is “IMGIN”		
		Required when: Allowed		
		Range: 1 to 9999999		
SENSOR HEIGHT	R-x\ISH-n	R/R Ch 10 Status: RO	Effective sensor height in pixels used to capture images.	
		Allowed when: R\CDT is “IMGIN”		
		Required when: Allowed		
		Range: 1 to 9999999		

**Table 9-4. Recorder-Reproducer Attributes Group (R)**

Parameter	Code Name	Usage Attributes	Definition
MAXIMUM IMAGE WIDTH	R-x\MIW-n	R/R Ch 10 Status: RO	Maximum image width in pixels.
		Allowed when: R\CDT is "IMGIN"	
		Required when: Allowed	
		Range: 1 to 9999999	
MAXIMUM IMAGE HEIGHT	R-x\MIH-n	R/R Ch 10 Status: RO	Maximum image height in pixels.
		Allowed when: R\CDT is "IMGIN"	
		Required when: Allowed	
		Range: Integer, 1-9999999	
IMAGE WIDTH	R-x\IW-n	R/R Ch 10 Status: RO	Image width in pixels.
		Allowed when: R\CDT is "IMGIN"	
		Required when: Allowed	
		Range: 1 to 9999999	
IMAGE HEIGHT	R-x\IH-n	R/R Ch 10 Status: RO	Image height in pixels.
		Allowed when: R\CDT is "IMGIN"	
		Required when: Allowed	
		Range: 1 to 9999999	
IMAGE OFFSET X	R-x\IOX-n	R/R Ch 10 Status: RO	Image horizontal offset from origin to area of interest in pixels.
		Allowed when: R\CDT is "IMGIN"	
		Required when: Allowed	
		Range: 1 to 9999999	
IMAGE OFFSET Y	R-x\IOY-n	R/R Ch 10 Status: RO	Image vertical offset from origin to area of interest in pixels.
		Allowed when: R\CDT is "IMGIN"	
		Required when: Allowed	
		Range: 1 to 9999999	
LINE PITCH	R-x\ILP-n	Allowed when: R\CDT is "IMGIN"	Total number of bytes between two successive lines.
		Range: 1 to 999999999	
BINNING HORIZONTAL	R-x\IBH-n	Allowed when: R\CDT is "IMGIN"	Number of horizontal photo-sensitive cells to combine together. A value of 1 indicates no horizontal binning.
		Range: 1 to 9999999	

**Table 9-4. Recorder-Reproducer Attributes Group (R)**

<b>Parameter</b>	<b>Code Name</b>	<b>Usage Attributes</b>		<b>Definition</b>
BINNING VERTICAL	R-x\IBV-n	Allowed when: R\CDT is “IMGIN”		Number of vertical photo-sensitive cells to combine together. A value of 1 indicates no vertical binning.
		Range: 1 to 9999999		
DECIMATION HORIZONTAL	R-x\IDH-n	Allowed when: R\CDT is “IMGIN”		Horizontal sub-sampling of the image. A value of 1 indicates no horizontal decimation.
		Range: 1 to 9999999		
DECIMATION VERTICAL	R-x\IDV-n	Allowed when: R\CDT is “IMGIN”		Vertical sub-sampling of the image. A value of 1 indicates no vertical decimation.
		Range: 1 to 9999999		
REVERSE X	R-x\IRX-n	Allowed when: R\CDT is “IMGIN”		Flip horizontally the image sent by the device. “T” (True). “F” (False).
		Range: Enumeration		
REVERSE Y	R-x\IRY-n	Allowed when: R\CDT is “IMGIN”		Flip vertically the image sent by the device.
		Range: Enumeration		
		Enumeration	Description	
		T	True	
		F	False	
PIXEL DYNAMIC RANGE MINIMUM	R-x\IPMN-n	Allowed when: R\CDT is “IMGIN”		Minimum value that can be returned during the digitization process.
		Range: 1 to 9999999		
PIXEL DYNAMIC RANGE MAXIMUM	R-x\IPMX-n	Allowed when: R\CDT is “IMGIN”		Maximum value that can be returned during the digitization process.
		Range: 1 to 9999999		
TEST IMAGE TYPE	R-x\TIT-n	Allowed when: R\CDT is “IMGIN”		Type of test image sent by the camera.
		Range: Enumeration		
		Enumeration		
		OFF		
		BLACK		
		WHITE		
		GREYHORIZONTALRAMP		
		GREYVERTICALRAMP		
GREYHORIZONTALRAMPMOVING				



**Table 9-4. Recorder-Reproducer Attributes Group (R)**

Parameter	Code Name	Usage Attributes	Definition	
		GREYVERTICALRAMPMOVING		
		HORIZONTALLINEMOVING		
		VERTICALLINEMOVING		
		COLORBAR		
		FRAMECOUNTER		
		DEVICESPECIFIC		
<b>UART Data Type Attributes</b>				
UART DATA TYPE FORMAT	R-x\UTF-n	R/R Ch 10 Status: RO	UART data type format.	
		Allowed when: R\CDT is "UARTIN"		
		Required when: Allowed		
		Range: Enumeration		
		Enumeration		Description
		0		Format 0
		1		Format 1
NUMBER OF UART SUB-CHANNELS	R-x\NUS\N-n	R/R Ch 10 Status: RO	Specify the number of UART sub-channels included within this channel.	
		Allowed when: R\CDT is "UARTIN"		
		Required when: Allowed		
		Range: 1 to 256		
UART SUB-CHANNEL NUMBER	R-x\USCN-n-m	R/R Ch 10 Status: RO	Specify the UART sub-channel number. First sub-channel is 1.	
		Allowed when: R\NUS\N > 0		
		Required when: Allowed		
		Range: 1 to 256		
UART SUB-CHANNEL NAME	R-x\UCNM-n-m	R/R Ch 10 Status: RO	Specify the UART sub-channel name.	
		Allowed when: R\NUS\N > 0		
		Required when: Allowed		
		Range: 32 characters		
UART SUB-CHANNEL BAUD RATE	R-x\UCR-n-m	R/R Ch 10 Status: RO	Baud rate in bits per second.	
		Allowed when: R\NUS\N > 0		
		Required when: Allowed		

**Table 9-4. Recorder-Reproducer Attributes Group (R)**

Parameter	Code Name	Usage Attributes	Definition	
		Range: positive floating point		
UART SUB-CHANNEL BITS PER WORD	R-x\UCB-n-m	R/R Ch 10 Status: RO	Bits per word (7, 8, or 9).	
		Allowed when: R\NUS\N > 0		
		Required when: Allowed		
		Range: 7, 8, or 9		
UART SUB-CHANNEL PARITY	R-x\UCP-n-m	R/R Ch 10 Status: RO		
		Allowed when: R\NUS\N > 0		
		Required when: Allowed		
		Range: Enumeration		
		Enumeration		Description
		O		Odd
		E		Even
N	None			
UART SUB-CHANNEL STOP BIT	R-x\UCS-n-m	R/R Ch 10 Status: RO	Stop bit size.	
		Allowed when: R\NUS\N > 0		
		Required when: Allowed		
		Range: Enumeration		
		Enumeration		Description
		0		1.0
		1		1.5
2	2.0			
UART SUB-CHANNEL INTERFACE	R-x\UCIN-n-m	Allowed when: R\NUS\N > 0	UART interface.	
		Required when: Allowed		
		Range: Enumeration		
		Enumeration		Description
		0		Other
		1		RS-232
		2		RS-422
3	RS-485			

**Table 9-4. Recorder-Reproducer Attributes Group (R)**

Table 9-4. Recorder-Reproducer Attributes Group (R)				
Parameter	Code Name	Usage Attributes		Definition
		4	TTL	
UART SUB-CHANNEL BLOCK SIZE	R-x\UCBS-n-m	Allowed when: R\NUS\N > 0		Block (frame) size in words.
		Required when: Allowed		
		Range: Integer, 0-999999		
UART SUB-CHANNEL SYNC WORD LENGTH	R-x\UCSL-n-m	Allowed when: R\UCBS > 1		Sync word length in words.
		Required when: Allowed		
		Range: 0 to 9		
UART SUB-CHANNEL BLOCK SYNC VALUE	R-x\UCSV-n-m	Allowed when: R\UCBS > 1		Block sync word value in binary. Specify all bits.
		Required when: Allowed		
		Range: Binary, 81 binary digits		
UART SUB-CHANNEL BLOCK RATE	R-x\UCBR-n-m	Allowed when: R\NUS\N > 0		Block rate in Hz
		Range: positive floating point		
Message Data Type Attributes				
MESSAGE DATA TYPE FORMAT	R-x\MTF-n	R/R Ch 10 Status: RO		Message data type format. Enumeration equates to format number in <a href="#">Chapter 10</a> .
		Allowed when: R\CDT is "MSGIN"		
		Required when: Allowed		
		Range: Enumeration		
		Enumeration	Description	
0	message data			
NUMBER OF MESSAGE SUB-CHANNELS	R-x\NMS\N-n	R/R Ch 10 Status: RO		Specify the number of message sub-channels included within this channel.
		Allowed when: R\CDT is "MSGIN"		
		Required when: Allowed		
		Range: 1 to 256		
MESSAGE SUB-CHANNEL NUMBER	R-x\MSCN-n-m	R/R Ch 10 Status: RO		Specify the message sub-channel number. The first sub-channel is 1.
		Allowed when: R\NMS\N > 0		
		Required when: Allowed		
		Range: Integer, 1-256		

**Table 9-4. Recorder-Reproducer Attributes Group (R)**

Parameter	Code Name	Usage Attributes	Definition	
MESSAGE SUB-CHANNEL NAME	R-x\MCNM-n-m	R/R Ch 10 Status: RO	Specify the message sub-channel name.	
		Allowed when: R\NMS\N > 0		
		Required when: Allowed		
		Range: 32 characters		
<b>IEEE-1394 Data Type Attributes</b>				
IEEE-1394 DATA TYPE FORMAT	R-x\IETF-n	R/R Ch 10 Status: RO	IEEE-1394 data type format. Enumeration equates to format number in <a href="#">Chapter 10</a> .	
		Allowed when: R\CDT is “1394IN”		
		Required when: Allowed		
		Range: Enumeration		
		Enumeration		Description
		0		IEEE-1394 TRANS
1	IEEE-1394 PHY			
<b>Parallel Data Type Attributes</b>				
PARALLEL DATA TYPE FORMAT	R-x\PLTF-n	R/R Ch 10 Status: RO	Parallel data type format. Enumeration equates to format number in <a href="#">Chapter 10</a> .	
		Allowed when: R\CDT is “PARIN”		
		Required when: Allowed		
		Range: Enumeration		
		Enumeration		Description
		0		Parallel
<b>Ethernet Data Type Attributes</b>				
ETHERNET DATA TYPE FORMAT	R-x\ENTF-n	R/R Ch 10 Status: RO	Ethernet data type format. Enumeration equates to format number in <a href="#">Chapter 10</a> .	
		Allowed when: R\CDT is “ETHIN”		
		Required when: Allowed		
		Range: Enumeration		
		Enumeration		Description
		0		Ethernet data

**Table 9-4. Recorder-Reproducer Attributes Group (R)**

Parameter	Code Name	Usage Attributes	Definition	
NUMBER OF ETHERNET NETWORKS	R-x\NNET\N-n	R/R Ch 10 Status: RO	Specify the number of Ethernet networks included within this channel.	
		Allowed when: R\CDT is "ETHIN"		
		Required when: Allowed		
		Range: 1 to 256		
ETHERNET NETWORK NUMBER	R-x\ENBR-n-m	R/R Ch 10 Status: RO	Specify the Ethernet network number. The first network number is 1.	
		Allowed when: R\NNET\N > 0		
		Required when: Allowed		
		Range: Integer, 1 to 256		
ETHERNET NETWORK NAME	R-x\ENAM-n-m	R/R Ch 10 Status: RO	Specify the Ethernet network name.	
		Allowed when: R\NNET\N > 0		
		Required when: Allowed		
		Range: 32 characters		
<b>TSPI/CTS Data Type Attributes</b>				
TSPI/CTS DATA TYPE FORMAT	R-x\TDTF-n	R/R Ch 10 Status: RO	TSPI/CTS data type format. Enumeration equates to format number in <a href="#">Chapter 10</a> .	
		Allowed when: R\CDT is "TSPIN"		
		Required when: Allowed		
		Range: Enumeration		
		Enumeration		Description
		0		NMEA-RTCM
		1		EAG ACMI
2	ACTTS			
<b>CAN Bus Data Type Attributes</b>				
CAN BUS DATA TYPE FORMAT	R-x\CBTF-n	R/R Ch 10 Status: RO	CAN bus data type format. Enumeration equates to format number in <a href="#">Chapter 10</a> .	
		Allowed when: R\CDT is "CANIN"		
		Required when: Allowed		
		Range: Enumeration		
		Enumeration		Description
		0		CAN bus

**Table 9-4. Recorder-Reproducer Attributes Group (R)**

<b>Table 9-4. Recorder-Reproducer Attributes Group (R)</b>					
<b>Parameter</b>	<b>Code Name</b>	<b>Usage Attributes</b>		<b>Definition</b>	
NUMBER OF CAN BUS SUB-CHANNELS	R-x\NCB\N-n	R/R Ch 10 Status: RO		Specify the number of CAN bus sub-channels in the packet.	
		Allowed when: R\CDT is “CANIN”			
		Required when: Allowed			
		Range: 1 to 256			
CAN BUS SUB-CHANNEL NUMBER	R-x\CBN-n-m	R/R Ch 10 Status: RO		Specify the CAN bus sub-channel ID. First sub-channel is 1.	
		Allowed when: R\NCB\N > 0			
		Required when: Allowed			
		Range: 1 to 256			
CAN BUS SUB-CHANNEL NAME	R-x\CBM-n-m	R/R Ch 10 Status: RO		Specify the CAN bus sub-channel name.	
		Allowed when: R\NCB\N > 0			
		Required when: Allowed			
		Range: 32 characters			
CAN BUS BIT RATE	R-x\CBBS-n-m	R/R Ch 10 Status: RO		Specify the bit rate of the CAN bus sub-channel in bits per second.	
		Allowed when: R\NCB\N > 0			
		Required when: Allowed			
		Range: positive floating point			
<b>Fibre Channel Data Type Attributes</b>					
FIBRE CHANNEL DATA TYPE FORMAT	R-x\FCTF-n	R/R Ch 10 Status: RO		Fibre Channel data type format	
		Allowed when: R\CDT is “FBCHIN”			
		Required when: Allowed			
		Range: Enumeration			
		Enumeration	Description		
		0	FC-PH		
		1	FC-FS		
FIBRE CHANNEL SPEED	R-x\FCSP-n	* R/R Ch 10 Status: RO		Fibre Channel speed (bit rate) for the port for frame capture.	
		Allowed when: R\CDT is “FBCHIN”			
		Required when: Allowed			
		Range: Enumeration			

		Enumeration	Description	
		0	1GFC (1.0625 gigabits per second [Gbps])	
		1	2GFC (2.125 Gbps)	
		2	4GFC (4.25 Gbps)	
		3	8GFC (8.5 Gbps)	
		4	10GFC (10.52 Gbps)	
		5	16GFC (14.025 Gbps)	
		6	32GFC (28.05 Gbps)	
<b>Telemetry Output</b>				
OUTPUT STREAM NAME	R-x\OSNM-n	Allowed when: R\CDT is "TMOUT"	Specify the recorder-reproducer channel group stream name to be included in the telemetry output.	
		Required when: Allowed		
		Links to: R-x\CGNM-n		
		Range: 32 characters		
STREAM ID	R-x\SID-n	Allowed when: R\CDT is "TMOUT"	Specify the stream ID for the minor frame header unprotected part	
		Range: 0 to 15		
		Default: 0		
CONFIGURATION HASH RATE	R-x\HRATE-n	Allowed when: R\CDT is "TMOUT"	Specify the rate of the Chapter 10 configuration packet hash code insertion into the telemetry output in seconds. Value 0 allows sending once after changes. Use character "N" for disable.	
		Range: 0 to 60, N		
		Default: "N", disabled		
CONFIGURATION PACKET RATE	R-x\CRATE-n	Allowed when: R\CDT is "TMOUT"	Specify the rate of the Chapter 10 configuration packet insertion into the telemetry output in seconds. Value 0 allows sending once after changes. Use character "N" for disable.	
		Range: 0 to 60, N		
		Default: "N", disabled		
<b>Reference Track</b>				
NUMBER OF REFERENCE TRACKS	R-x\RT\N	Allowed when: R\NCB\N > 0	Specify the number of reference tracks.	
		Range: 1 to 9		
TRACK NUMBER	R-x\RT1-n	Allowed when: R\RT\N > 0	State the track location of the reference signal.	
		Required when: Allowed		
		Range: 1 to 99		

REFERENCE FREQUENCY	R-x\RT2-n	Allowed when: R\RT\N > 0	Frequency of reference signal, in kHz.
		Required when: Allowed	
		Range: 6 characters	
<b>NOTE:</b> There will be one tape/storage source attributes group for each tape or storage source.			
<b>Comments</b>			
COMMENTS	R-x\COM	R/R Ch 10 Status: RO	Provide the additional information requested or any other information desired.
		Allowed when: R\ID is specified	
		Range: 3200 characters	



9.5.5 Multiplex/Modulation (Mux/Mod) Attributes (M)

The composite baseband waveform is received from the receiver or tape reproducer electronics and is passed to the demultiplexer/demodulator for further processing. [Figure 9-5](#) summarizes the information that is required to continue processing the data. The composite baseband waveform may consist of any number of signals that are modulated directly onto the RF carrier, including a baseband data signal and one or more subcarriers.

The baseband data signal may be PCM or analog data. The PCM data streams must be defined in terms of a data link name. This data link name is unique for each system that contains different data, has a different format, or has a different data rate. The analog measurand is typically converted into engineering units appropriate for the measurand. The measurement name provides the connection to the Data Conversion Attributes group (C).

Subcarriers, both standard and nonstandard, may be part of the baseband composite waveform. These, in turn, may be modulated with PCM or analog data. As with the baseband data signal, these data channels must be defined. [Table 9-5](#) specifies the required information for the data signal attributes.

<b>Figure 9-5. Multiplex/Modulation Attributes Group (M)</b>		<b>Code Name</b>
<b>DATA SOURCE ID - <a href="#">9-87</a></b>		(M-x\ID)
<a href="#">9-87</a>	<b>*Composite Signal Structure</b>	
	SIGNAL STRUCTURE TYPE	(M-x\BB1)
	MODULATION SENSE	(M-x\BB2)
	COMPOSITE LPF BANDWIDTH	(M-x\BB3)
<a href="#">9-87</a>	<b>*Baseband Signal</b>	
	BASEBAND SIGNAL TYPE	(M-x\BSG1)
	<b>*Low Pass Filter</b>	
	BANDWIDTH	(M-x\BSF1)
	TYPE	(M-x\BSF2)
<a href="#">9-88</a>	<b>*Baseband Data Link Type</b>	
	<b>*PCM</b>	
	OR	
	DATA LINK NAME	(M-x\BB\DLN)
	<b>*Analog</b>	
	MEASUREMENT NAME	(M-x\BB\MN)
<a href="#">9-89</a>	<b>*Subcarriers</b>	
	NUMBER OF SUBCARRIERS	(M-x\SCO\N)
	<b>*IRIG Subcarriers</b>	
	NUMBER OF SCOs	(M-x\SI\N)
	SCO NUMBER	(M-x\SI1-n)
	SCO #n DATA TYPE	(M-x\SI2-n)
	MODULATION SENSE	(M-x\SI3-n)
<a href="#">9-89</a>	<b>*Low Pass Filter</b>	
	BANDWIDTH	(M-x\SIF1-n)
	TYPE	(M-x\SIF2-n)
<a href="#">9-90</a>	<b>*Data Link Type</b>	
	<b>*PCM</b>	

	DATA LINK NAME	(M-x\SI\DLN-n)
	OR *Analog	
<a href="#">9-90</a>	MEASUREMENT NAME	(M-x\SI\MN-n)
	OTHER	(M-x\SO)
<a href="#">9-91</a>	REFERENCE CHANNEL	(M-x\RC)
	*Comments	
	COMMENTS	(M-x\COM)
*Heading Only - No Data Entry		

**Table 9-5. Multiplex/Modulation Group (M)**

Parameter	Code Name	Usage Attributes	Definition	
DATA SOURCE ID	M-x\ID	Allowed when: defining multiplexed data	Data source identification.	
		Required when: Allowed		
		Links from: G\DSI-n, T-x\ID		
		Range: 32 characters		
<b>Composite Signal Structure</b>				
SIGNAL STRUCTURE TYPE	M-x\BB1	Allowed when: M\ID is specified	Specify the composite baseband signal structure.	
		Required when: Allowed		
		Range: Enumeration		
		Enumeration		Description
		PCM		
		ANALOG		
		SCO's		
		OTHER		
		ANA/SCO		Hybrid
PCM/SCO	Hybrid			
MODULATION SENSE	M-x\BB2	Allowed when: M\ID is specified	Specify the modulation sense: "POS" - indicates that an increasing voltage results in an increase in frequency. "NEG" - indicates that a decreasing voltage results in an increase in frequency.	
		Range: Enumeration		
		Enumeration		Description
		POS		
NEG				
COMPOSITE LPF BANDWIDTH	M-x\BB3	Allowed when: M\ID is specified	Give the low pass bandwidth of the composite waveform (3 dB cutoff frequency), in kHz.	
		Range: 6 characters		
<b>Baseband Signal</b>				
BASEBAND SIGNAL TYPE	M-x\BSG1	Allowed when: M\BB1 is not "SCO's" or "OTHER"	Type of baseband data.	
		Required when: Allowed		
		Range: Enumeration		
		Enumeration		Description
PCM				

**Table 9-5. Multiplex/Modulation Group (M)**

<b>Table 9-5. Multiplex/Modulation Group (M)</b>				
<b>Parameter</b>	<b>Code Name</b>	<b>Usage Attributes</b>		<b>Definition</b>
		ANA	Analog	
		OTH	Other	
		NON	None	
<b>Low-Pass Filter</b>				
BANDWIDTH	M-x\BSF1	Allowed when: defining multiplexed data Range: 6 characters		Specify low pass filter bandwidth (3 dB cutoff frequency), in kHz.
TYPE	M-x\BSF2	Allowed when: defining multiplexed data Range: Enumeration		
		Enumeration	Description	Specify the filter type.
		CA	Constant amplitude	
		CD	Constant delay	
		OT	Other, define in the comments	
<b>Baseband Data Link Type</b>				
<b>PCM</b>				
DATA LINK NAME	M-x\BB\DLN	Allowed when: M\BB1 is not "SCO's" or "OTHER" and M\BSG1 is "PCM" Required When: Allowed Links to: P-d\DLN Range: 32 characters		Specify the data link name for PCM data format.
<b>Analog</b>				
MEASUREMENT NAME	M-x\BB\MN	Allowed when: M\BB1 is not "SCO's" or "OTHER" and M\BSG1 is "ANA" Required When: Allowed Links to: C-d\DCN Range: 32 characters		Give the measurand name.

**Table 9-5. Multiplex/Modulation Group (M)**

Parameter	Code Name	Usage Attributes	Definition	
<b>Subcarriers</b>				
NUMBER OF SUBCARRIERS	M-x\SCO\N	Allowed when: M\BB1 not “PCM” or “ANALOG”	Specify the number of subcarriers on this data link.	
		Required when: Allowed		
		Range: 2 characters		
<b>IRIG Subcarriers</b>				
NUMBER OF SCOS	M-x\SI\N	Allowed when: M\BB1 is “SCO's” or “ANA/SCO” or “PCM/SCO”	Specify the number of IRIG subcarriers.	
		Required when: Allowed		
		Range: 2 characters		
SCO NUMBER	M-x\SI1-n	Allowed when: M\SI\N > 0	Give the IRIG channel number for the subcarrier.	
		Required when: Allowed		
		Range: 5 characters		
SCO #N DATA TYPE	M-x\SI2-n	Allowed when: M\SI\N > 0	Specify the type of data on the subcarrier.	
		Required when: Allowed		
		Range: Enumeration		
		Enumeration		Description
		PCM		
		ANA		Analog
OTH	Other			
MODULATION SENSE	M-x\SI3-n	Allowed when: M\SI\N > 0	Specify the modulation sense: “POS” - indicates that an increasing voltage results in an increase in frequency. “NEG” - indicates that a decreasing voltage results in an increase in frequency.	
		Range: Enumeration		
		Enumeration		Description
		POS		
NEG				
<b>Low-Pass Filter</b>				
BANDWIDTH	M-x\SIF1-n	Allowed when: M\ID is specified	Specify the low pass filter cutoff frequency (3 dB), in kHz.	
		Range: 6 characters		
TYPE	M-x\SIF2-n	Allowed when: M\ID is specified	Specify the filter type.	

**Table 9-5. Multiplex/Modulation Group (M)**

Parameter	Code Name	Usage Attributes	Definition	
		Range: Enumeration		
		Enumeration	Description	
		CA	Constant amplitude	
		CD	Constant delay	
		OT	Other, define in the comments	
<b>Data Link Type</b>				
<b>PCM</b>				
DATA LINK NAME	M-x\SI\DLN-n	Allowed when: M\BB1 is not “PCM” or “ANALOG” and M\SI2 is “PCM”	Specify the data link name for PCM data formats.	
		Required when: Allowed		
		Links to: P-d\DLN		
		Range: 32 characters		
<b>Analog</b>				
MEASUREMENT NAME	M-x\SI\MN-n	Allowed when: M\BB1 is not “PCM” or “ANALOG” and M\SI2 is “ANA”	Give the measurand name.	
		Required when: Allowed		
		Links to: C-d\DCN		
		Range: 32 characters		
<b>NOTE:</b> Repeat the above for each IRIG subcarrier on this carrier.				
OTHER	M-x\SO	Allowed when: M\ID is specified	Are there nonstandard subcarriers? Define in the comments.	
		Range: Enumeration		
		Enumeration		Description
		Y		Yes
		N		No
		Default: N		
REFERENCE CHANNEL	M-x\RC	Allowed when: M\ID is specified	Frequency of reference channel in kHz, if applicable.	
		Range: 6 characters		

**Table 9-5. Multiplex/Modulation Group (M)**

<b>Table 9-5. Multiplex/Modulation Group (M)</b>			
<b>Parameter</b>	<b>Code Name</b>	<b>Usage Attributes</b>	<b>Definition</b>
<b>Comments</b>			
COMMENTS	M-x\COM	Allowed when: M\ID is specified	Provide the additional information requested or any other information desired.
		Range: 3200 characters	

## 9.5.6 PCM Format Attributes (P)

The PCM Format Attributes group contains the information required to decommutate the PCM data stream. Operations of both Class I and Class II are included. Limited information is incorporated for class II operations. [Figure 9-6](#) presents the flow and summary of the information required. In general, only standard methods of synchronization have been included except for cases where considerable application is already in place. Inclusion should not be taken to mean that the nonstandard approaches are better or desired. [Table 9-6](#) contains the PCM Format Attributes. The group defines and specifies the frame format and the information necessary to set up the PCM decommutation. Refer to [Chapter 4](#) for the definition of terms (such as major and minor frames and subframes) and word numbering conventions.

<b>Figure 9-6. PCM Format Attributes Group (P)</b>		<b>Code Name</b>
<b>DATA LINK NAME - <a href="#">9-95</a></b>		(P-d\DLN)
<a href="#">9-95</a>	<b>*Input Data</b>	
	PCM CODE	(P-d\D1)
	BIT RATE	(P-d\D2)
	ENCRYPTED	(P-d\D3)
	POLARITY	(P-d\D4)
	AUTO-POLARITY CORRECTION	(P-d\D5)
	DATA DIRECTION	(P-d\D6)
	DATA RANDOMIZED	(P-d\D7)
	RANDOMIZER LENGTH	(P-d\D8)
<a href="#">9-97</a>	<b>*Format</b>	
	TYPE FORMAT	(P-d\TF)
	COMMON WORD LENGTH	(P-d\F1)
	WORD TRANSFER ORDER	(P-d\F2)
	PARITY	(P-d\F3)
	PARITY TRANSFER ORDER	(P-d\F4)
	CRC	(P-d\CRC)
	CRC CHECK WORD STARTING BIT	(P-d\CRCCB)
	CRC DATA START BIT	(P-d\CRCDDB)
	CRC DATA NUMBER OF BITS	(P-d\CRCDN)
<a href="#">9-99</a>	<b>*Minor Frame</b>	
	NUMBER OF MINOR FRAMES IN MAJOR FRAME	(P-d\MF\N)
	NUMBER OF WORDS IN A MINOR FRAME	(P-d\MF1)
	NUMBER OF BITS IN A MINOR FRAME	(P-d\MF2)
	SYNC TYPE	(P-d\MF3)
<a href="#">9-100</a>	<b>*Synchronization Pattern</b>	
	LENGTH	(P-d\MF4)
	PATTERN	(P-d\MF5)
<a href="#">9-100</a>	<b>*Synchronization Criteria</b>	
	IN SYNC CRITERIA	(P-d\SYNC1)
	SYNC PATTERN CRITERIA	(P-d\SYNC2)
<a href="#">9-101</a>	<b>*Out of Synchronization Criteria</b>	



		NUMBER OF DISAGREES	(P-d\SYNC3)
		SYNC PATTERN CRITERIA	(P-d\SYNC4)
		FILL BITS	(P-d\SYNC5)
<a href="#">9-101</a>	<b>*Minor Frame Format Definition</b>		
		NUMBER OF UNIQUE WORD SIZES	(P-d\MFW\N)
		WORD NUMBER	(P-d\MFW1-n)
		NUMBER OF BITS IN WORD	(P-d\MFW2-n)
<a href="#">9-102</a>	<b>*Subframe Synchronization</b>		
		NUMBER OF SUBFRAME ID COUNTERS	(P-d\ISF\N)
		SUBFRAME ID COUNTER NAME	(P-d\ISF1-n)
		SUBFRAME SYNC TYPE	(P-d\ISF2-n)
<a href="#">9-102</a>	<b>*ID Counter</b>		
		SUBFRAME ID COUNTER LOCATION	(P-d\IDC1-n)
<a href="#">9-103</a>		ID COUNTER MSB STARTING BIT LOCATION	(P-d\IDC3-n)
		ID COUNTER LENGTH	(P-d\IDC4-n)
		ID COUNTER TRANSFER ORDER	(P-d\IDC5-n)
		ID COUNTER INITIAL VALUE	(P-d\IDC6-n)
		INITIAL COUNT MINOR FRAME NUMBER	(P-d\IDC7-n)
		ID COUNTER END VALUE	(P-d\IDC8-n)
		END COUNT MINOR FRAME NUMBER	(P-d\IDC9-n)
		COUNT DIRECTION	(P-d\IDC10-n)
<a href="#">9-104</a>	<b>*Asynchronous Embedded Format</b>		
		NUMBER OF ASYNCHRONOUS EMBEDDED FORMATS	(P-d\AEF\N)
		DATA LINK NAME	(P-d\AEF\DLN-n)
		SUPERCOM	(P-d\AEF1-n)
		LOCATION DEFINITION	(P-d\AEF2-n)
		LOCATION	(P-d\AEF3-n-w)
		INTERVAL	(P-d\AEF4-n)
		WORD LENGTH	(P-d\AEF5-n-w)
		MASK	(P-d\AEF6-n-w)
		SUBCOMMUTATED	(P-d\AEF7-n-w)
		START FRAME	(P-d\AEF8-n-w-m)
		FRAME INTERVAL	(P-d\AEF9-n-w-m)
<a href="#">9-106</a>	<b>*Format Change</b>		
	<b>*Frame Format Identifier</b>		
		LOCATION	(P-d\FFI1)
		MASK	(P-d\FFI2)
<a href="#">9-106</a>	<b>*Measurement List Change</b>		
		NUMBER OF MEASUREMENT LISTS	(P-d\MLC\N)
		FFI PATTERN	(P-d\MLC1-n)
		MEASUREMENT LIST NAME	(P-d\MLC2-n)
<a href="#">9-107</a>	OR	<b>*Format Structure Change</b>	

	NUMBER OF FORMATS	(P-d\FSC\N)
	FFI PATTERN	(P-d\FSC1-n)
	DATA LINK ID	(P-d\FSC2-n)
<a href="#">9-107</a>	<b>*Alternate Tag And Data</b>	
	NUMBER OF TAGS	(P-d\ALT\N)
	NUMBER OF BITS IN TAG	(P-d\ALT1)
	NUMBER OF BITS IN DATA WORD	(P-d\ALT2)
	FIRST TAG LOCATION	(P-d\ALT3)
	SEQUENCE	(P-d\ALT4)
<a href="#">9-108</a>	<b>*Asynchronous Data Merge Format</b>	
	NUMBER OF ASYNCHRONOUS DATA MERGE FORMATS	(P-d\ADM\N)
	DATA MERGE NAME	(P-d\ADM\DMN-n)
	MASK AND PATTERN	(P-d\ADM\MP-n)
	OVERHEAD MASK	(P-d\ADM\OHM-n)
	FRESH DATA PATTERN	(P-d\ADM\FDP-n)
	DATA OVERFLOW PATTERN	(P-d\ADM\DOP-n)
	STALE DATA PATTERN	(P-d\ADM\SDP-n)
	USER DEFINED PATTERN	(P-d\ADM\UDP-n)
	SUPERCOM	(P-d\ADM1-n)
	LOCATION DEFINITION	(P-d\ADM2-n)
	LOCATION	(P-d\ADM3-n-w)
	INTERVAL	(P-d\ADM4-n)
	DATA LENGTH	(P-d\ADM5-n)
	MSB LOCATION	(P-d\ADM6-n)
	PARITY	(P-d\ADM7-n)
	SUBCOMMUTATED	(P-d\ADM8-n-w)
	START FRAME	(P-d\ADM9-n-w-m)
	FRAME INTERVAL	(P-d\ADM10-n-w-m)
<a href="#">9-111</a>	<b>*Chapter 7 Format</b>	
	CHAPTER 7 NUMBER OF SEGMENTS	(P-d\C7\N)
	CHAPTER 7 FIRST WORD OF SEGMENT	(P-d\C7FW-n)
	CHAPTER 7 NUMBER OF PCM WORDS IN SEGMENT	(P-d\C7NW-n)
	<b>*Comments</b>	
<a href="#">9-111</a>	COMMENTS	(P-d\COM)
<b>*Heading Only - No Data Entry</b>		

**Table 9-6. PCM Format Attributes Group (P)**

Parameter	Code Name	Usage Attributes	Definition	
DATA LINK NAME	P-d\DLN	R/R Ch 10 Status: RO	Identify the data link name consistent with the mux/mod group.	
		Allowed when: defining PCM data		
		Required when: Allowed		
		Links from: M-x\BB\DLN, M-x\SI\DLN-n, R-x\CDLN, P-d\AEF\DLN-n, P-d\FSC2-n, P-d\ADM\DMN-n, R-x\EV\DLN-n		
		Links to: D-x\DLN, B-d\DLN		
		Range: 32 characters		
<b>Input Data</b>				
PCM CODE	P-d\D1	R/R Ch 10 Status: RO	Define the data format code. A randomized PCM stream can be specified as: “P-d\D1=NRZ-L” and “P-d\D7=Y”; or “P-d\D1=RNRZ-L” and “P-d\D7” is ignored.	
		Allowed when: P-d\DLN is specified		
		Range: Enumeration		
		Enumeration		Description
		NRZ-L		Non-return-to-zero-level
		NRZ-M		Non-return-to-zero-mark
		NRZ-S		Non-return-to-zero-space
		RNRZ-L		Randomized, non-return-to-zero-level
		BIO-M		Bi-phase-mark
		BIO-L		Bi-phase-level
		BIO-S		Bi-phase-space
		OTHER		Other encoding, define in comments
		Default: NRZ-L		
BIT RATE	P-d\D2	R/R Ch 10 Status: RO	Data rate in bits per second.	
		Allowed when: P-d\DLN is specified		
		Required when: Allowed		
		Range: positive floating point		
ENCRYPTED	P-d\D3	Allowed when: P-d\DLN is specified	If the data is encrypted, provide details in comments.	

**Table 9-6. PCM Format Attributes Group (P)**

Parameter	Code Name	Usage Attributes	Definition
		Range: Enumeration	
		Enumeration      Description	
		E                      Data is encrypted	
		U                      Data is unencrypted	
		Default: U	
POLARITY	P-d\D4	R/R Ch 10 Status: RO	Input Stream Data polarity.
		Allowed when: P-d\DLN is specified	
		Range: Enumeration	Note. The polarity of the input stream at the source.
		Enumeration      Description	The source could be an airborne DAU or a ground receiver.
		N                      Normal	
		I                      Inverted	
		Default: N	
AUTO-POLARITY CORRECTION	P-d\D5	Allowed when: P-d\DLN is specified	Is automatic polarity correction to be used?
		Range: Enumeration	
		Enumeration      Description	
		Y                      Yes	
		N                      No	
		Default: N	
DATA DIRECTION	P-d\D6	Allowed when: P-d\DLN is specified	Time sequence of data.
		Range: Enumeration	
		Enumeration      Description	
		N                      Normal	
		R                      Reversed	
		Default: N	
DATA RANDOMIZED	P-d\D7	R/R Ch 10 Status: RO	Randomization algorithm is specified in
		Allowed when: P-d\DLN is specified	“RANDOMIZER LENGTH” (P-d\D8).
		Range: Enumeration	
		Enumeration      Description	
		Y                      Yes	

**Table 9-6. PCM Format Attributes Group (P)**

Parameter	Code Name	Usage Attributes		Definition
		N	No	
		Default: N		
RANDOMIZER LENGTH	P-d\D8	R/R Ch 10 Status: RO		Specify the randomizer length.
		Allowed when: P-d\D7 = Y		
		Range: Enumeration		
		Enumeration	Description	
		STD	15 bits, per <a href="#">Annex A.2</a>	
		OTH	Other, define in comments	
		N/A	Not applicable	
		Default: STD		
<b>Format</b>				
TYPE FORMAT	P-d\TF	R/R Ch 10 Status: RO		Type of PCM format.
		Allowed when: P-d\DLN is specified		
		Range: Enumeration		
		Enumeration	Description	
		ONE	Class I	
		TWO	Class II	
		BUS	1553 bus	
		1553	1553 bus	
		ALTD	Alternate tag and data	
		OTHR	Other, define in comments	
Default: ONE				
COMMON WORD LENGTH	P-d\F1	R/R Ch 10 Status: RO-PAK		Number of bits in common word length.
		Allowed when: P-d\DLN is specified		
		Required when: Allowed and defining CH10 non-throughput mode		
		Range: 4-64		

**Table 9-6. PCM Format Attributes Group (P)**

Parameter	Code Name	Usage Attributes	Definition	
WORD TRANSFER ORDER	P-d\F2	R/R Ch 10 Status: RO-PAK	Define the default for the first bit transferred in normal time sequence.	
		Allowed when: P-d\DLN is specified		
		Required when: Allowed and defining CH10 non-throughput mode		
		Range: Enumeration		
		Enumeration		Description
		M		msb
		L		lsb
Default: M				
PARITY	P-d\F3	R/R Ch 10 Status: RO-PAK	Normal word parity.	
		Allowed when: P-d\DLN is specified		
		Required when: Allowed and defining CH10 non-throughput mode		
		Range: Enumeration		
		Enumeration		Description
		EV		Even
		OD		Odd
NO	None			
Default NO				
PARITY TRANSFER ORDER	P-d\F4	Allowed when: P-d\F3 is not NO	Parity bit location.	
		Required when: Allowed		
		Range: Enumeration		
		Enumeration		Description
		L		Leads word
T	Trails word			
CRC	P-d\CRC	Allowed when: P-d\DLN is specified	Specify what type of cyclic redundancy code is to be used.	
		Range: Enumeration		
		Enumeration		Description
A	CRC-16-ANSI			

**Table 9-6. PCM Format Attributes Group (P)**

Parameter	Code Name	Usage Attributes	Definition
		C CRC-16-CCITT	
		E CRC-32-ANSI	
		N None	
		Default: N	
CRC CHECK WORD STARTING BIT	P-d\CRCB	Allowed when: When P-d\CRC is not N Required when: Allowed Range: 1 to the value of P-d\MF2	The starting bit number in the minor frame where the CRC check word begins. The CRC check word must occupy contiguous bits of the minor frame even if the check word crosses word boundaries. The check word shall always be inserted msb first.
CRC DATA START BIT	P-d\CRCDB	Allowed when: When P-d\CRC is not N Required when: Allowed Range: 1 to the value of P-d\MF2	The starting bit number in the minor frame of the data used in the CRC calculation.
CRC DATA NUMBER OF BITS	P-d\CRCDN	Allowed when: When P-d\CRC is not N Required when: Allowed Range: 1 to the value of P-d\MF2	The number of data bits used in the CRC calculation. The data being checked may span 2 minor frames but is never longer than a single minor frame. Minor frame fill bits are never used as part of a CRC calculation.
<b>Minor Frame</b>			
NUMBER OF MINOR FRAMES IN MAJOR FRAME	P-d\MF\N	R/R Ch 10 Status: RO-PAK Allowed when: P-d\DLN is specified Required when: Allowed and defining CH10 non-throughput mode Range: 1 to 256 Default: 1	Number of minor frames in a major frame.
NUMBER OF WORDS IN A MINOR FRAME	P-d\MF1	R/R Ch 10 Status: RO-PAK Allowed when: P-d\DLN is specified Required when: Allowed and defining CH10 non-throughput mode Range: 2-4096	Specify the number of words in a minor frame, as defined in <a href="#">Chapter 4</a> , Section 4.3 (the minor frame synchronization pattern is always considered as one word, regardless of its length).

**Table 9-6. PCM Format Attributes Group (P)**

<b>Parameter</b>	<b>Code Name</b>	<b>Usage Attributes</b>	<b>Definition</b>	
NUMBER OF BITS IN A MINOR FRAME	P-d\MF2	R/R Ch 10 Status: RO-PAK	Number of bits in a minor frame including minor frame synchronization pattern.	
		Allowed when: P-d\DLN is specified		
		Required when: P-d\CRC is not N or defining CH10 non-throughput mode		
		Range: 20 to 16384		
SYNC TYPE	P-d\MF3	Allowed when: P-d\DLN is specified	Define minor frame synchronization type.	
		Range: Enumeration		
		Enumeration		Description
		FPT		Fixed pattern
		ACC		Alternating Code Complement
		OTH		Other, define in comments
		Default: FPT		
<b>Synchronization Pattern</b>				
LENGTH	P-d\MF4	R/R Ch 10 Status: RO-PAK	Specify the minor frame synchronization pattern length in number of bits.	
		Allowed when: P-d\DLN is specified		
		Required when: Allowed and defining CH10 non-throughput mode		
		Range: 16 to 33		
PATTERN	P-d\MF5	R/R Ch 10 Status: RO-PAK	Define minor frame synchronization pattern in bits (1s and 0s) with the left-most bit as the first bit transmitted. "X" may be used to indicate a "don't care" bit.	
		Allowed when: P-d\DLN is specified		
		Required when: Allowed and defining CH10 non-throughput mode		
		Range: The value of MF4 count of binary pattern		
<b>Synchronization Criteria</b>				
IN-SYNC CRITERIA	P-d\SYNC1	Allowed when: P-d\DLN is specified	This specifies the desired criteria for declaring the system to be in sync. "0" (First good sync). Number of good sync patterns (1 or greater). "NS" (Not specified).	
		Range: 0 to 99 or NS		
		Default: NS		



**Table 9-6. PCM Format Attributes Group (P)**

<b>Parameter</b>	<b>Code Name</b>	<b>Usage Attributes</b>	<b>Definition</b>
SYNC PATTERN CRITERIA	P-d\SYNC2	Allowed when: P-d\SYNC1 is not NS	Number of bits that may be in error in the synchronization pattern.
		Required when: Allowed	
		Range: 0 to the value of P-d\MF4	
<b>Out of Synchronization Criteria</b>			
NUMBER OF DISAGREES	P-d\SYNC3	Allowed when: P-d\DLN is specified	Specify the desired criteria for declaring the system out of sync. Number of bad sync patterns, (1 or greater). "NS" (Not specified).
		Range: 0 to 99 or NS	
		Default: NS	
SYNC PATTERN CRITERIA	P-d\SYNC4	Allowed when: P-d\SYNC3 is not NS	Number of bits that may be in error in the synchronization pattern.
		Required when: Allowed	
		Range: 0 to the value of P-d\MF4	
FILL BITS	P-d\SYNC5	Allowed when: P-d\DLN is specified	Max number of fill bits between end of frame and next sync pattern that can be ignored.
		Range: 0-16384	
		Default: 0	
<b>Minor Frame Format Definition</b>			
NUMBER OF UNIQUE WORD SIZES	P-d\MFW\N	R/R Ch 10 Status: RO-PAK	Count of words that are not the default word size
		Allowed when: P-d\DLN is specified and words are sized other than the default word size	
		Required when: Allowed and defining CH10 non-throughput mode	
		Range: 0 to the value of P-d\MF1 minus 1	
WORD NUMBER	P-d\MFW1-n	R/R Ch 10 Status: RO-PAK	Word position in the minor frame. Word position 1 follows the synchronization pattern.
		Allowed when: P-d\DLN is specified and words are sized other than the default word size	
		Required when: Allowed and defining CH10 non-throughput mode	
		Range: 1 to the value of P-d\MF1 minus 1	

**Table 9-6. PCM Format Attributes Group (P)**

Parameter	Code Name	Usage Attributes	Definition	
NUMBER OF BITS IN WORD	P-d\MFW2-n	R/R Ch 10 Status: RO-PAK	The number of bits in word position defined by P-d\MFW1-n. If default value, do not include.	
		Allowed when: P-d\MFW1 is specified		
		Required when: Allowed		
		Range: 4-64		
<b>NOTE:</b> The above pair set must be defined for all words that have a length other than the common word length. Therefore, all word positions not included in the above will have the common word length as a default value.				
<b>Subframe Synchronization</b>				
NUMBER OF SUBFRAME ID COUNTERS	P-d\ISF\N	R/R Ch 10 Status: RO-PAK	Specify the number of subframe ID counters defined within the minor frame.	
		Allowed when: P-d\DLN is specified		
		Range: 0-10		
		Default: 0		
SUBFRAME ID COUNTER NAME	P-d\ISF1-n	R/R Ch 10 Status: RO-PAK	Specify the subframe ID counter name.	
		Allowed when: P-d\ISF\N is greater than 0		
		Required when: P-d\ISF\N is greater than 1		
		Range: 32 characters		
SUBFRAME SYNC TYPE	P-d\ISF2-n	R/R Ch 10 Status: RO-PAK	Define the subframe synchronization type.	
		Allowed when: P-d\ISF\N is greater than 0		
		Range: Enumeration		
		Enumeration		Description
		ID		ID counter
		OT		Other, define in comments
		Default: ID		
<b>ID Counter</b>				
SUBFRAME ID COUNTER LOCATION	P-d\IDC1-n	R/R Ch 10 Status: RO-PAK	If ID counter is designated as the subframe sync type, give the minor frame word position of the counter.	
		Allowed when: P-d\ISF\N is greater than 0		
		Required when: Allowed and defining CH10 non-throughput mode		
		Range: 1 to value of P-d\MF1-1		

**Table 9-6. PCM Format Attributes Group (P)**

Parameter	Code Name	Usage Attributes	Definition	
ID COUNTER MSB STARTING BIT LOCATION	P-d\IDC3-n	R/R Ch 10 Status: RO-PAK	Specify the bit location of the ID counter msb within the word.	
		Allowed when: P-d\ISF\N is greater than 0		
		Required when: Allowed and defining CH10 non-throughput mode		
		Range: 1 to size of word (either P-d\MFW2-n or P-d\F1)		
ID COUNTER LENGTH	P-d\IDC4-n	R/R Ch 10 Status: RO-PAK	Specify the subframe ID counter length, number of bits.	
		Allowed when: P-d\ISF\N is greater than 0		
		Required when: Allowed		
		Range: 1 to size of word (either P-d\MFW2-n or P-d\F1)		
ID COUNTER TRANSFER ORDER	P-d\IDC5-n	R/R Ch 10 Status: RO-PAK	Specify whether the msb or lsb is transferred first.	
		Allowed when: P-d\ISF\N is greater than 0		
		Range: Enumeration		
		Enumeration		Description
		M		msb
		L		lsb
		D		As specified in WORD TRANSFER ORDER (P-d\F2).
Default: D				
ID COUNTER INITIAL VALUE	P-d\IDC6-n	R/R Ch 10 Status: RO-PAK	Specify the initial value of the ID counter.	
		Allowed when: P-d\ISF\N is greater than 0		
		Required when: Allowed		
		Range: 0, 1, number of minor frames minus 1, number of minor frames		
INITIAL COUNT MINOR FRAME NUMBER	P-d\IDC7-n	R/R Ch 10 Status: RO-PAK	Specify the minor frame number associated with the initial count value.	
		Allowed when: P-d\ISF\N is greater than 0		
		Range: 1		

**Table 9-6. PCM Format Attributes Group (P)**

Parameter	Code Name	Usage Attributes	Definition	
		Default: 1		
ID COUNTER END VALUE	P-d\IDC8-n	R/R Ch 10 Status: RO-PAK	Specify the end value of the ID counter.	
		Allowed when: P-d\ISF\N is greater than 0		
		Required when: Allowed		
		Range: 0, 1, number of minor frames minus 1, number of minor frames		
END COUNT MINOR FRAME NUMBER	P-d\IDC9-n	R/R Ch 10 Status: RO-PAK	Specify the minor frame number associated with the end count value.	
		Allowed when: P-d\ISF\N is greater than 0		
		Range: Number of minor frames		
COUNT DIRECTION	P-d\IDC10-n	R/R Ch 10 Status: RO-PAK	Specify the direction of the count increment.	
		Allowed when: P-d\ISF\N is greater than 0		
		Range: Enumeration		
		Enumeration		Description
		INC		Increasing
		DEC		Decreasing
		Default: INC		
<b>Asynchronous Embedded Format</b>				
NUMBER OF ASYNCHRONOUS EMBEDDED FORMATS	P-d\AEF\N	Allowed when: P-d\DLN specified	Specify the number of asynchronous embedded formats.	
		Range: 0 to 99		
		Default: 0		
DATA LINK NAME	P-d\AEF\DLN-n	Allowed when: P-d\AEF\N is greater than 0	Provide the data link name for this asynchronous embedded format. Repeat name and the following entries for the second format, as appropriate. A separate data link definition must be provided for each asynchronous embedded format.	
		Required when: Allowed		
		Links to: P-d\DLN		
		Range: 32 characters		
SUPERCOM	P-d\AEF1-n	Allowed when: P-d\AEF\N is greater than 0	If the asynchronous format is not supercommutated, enter "NO". Otherwise, enter the number of host minor frame words that are used.	
		Required when: Allowed		
		Range: 1 to P-d\MF1 minus 1 or NO		

**Table 9-6. PCM Format Attributes Group (P)**

Parameter	Code Name	Usage Attributes	Definition	
LOCATION DEFINITION	P-d\AEF2-n	Allowed when: P-d\AEF\N is greater than 0	If supercommutated, specify how the word locations are defined.	
		Required when: Allowed		
		Range: Enumeration		
		Enumeration		Description
		F1		First word and interval
		EL		Every location
		CW		Contiguous words
	NA	Not applicable		
LOCATION	P-d\AEF3-n-w	Allowed when: P-d\AEF\N is greater than 0	Specify the first word within the minor frame that contains the asynchronous embedded format identified. For the method when every word location is defined, repeat this entry for each word position applicable. For the first word and interval method, include the next entry to define the interval.	
		Required when: Allowed		
		Range: 1 to value of P-d\MF1 minus 1		
INTERVAL	P-d\AEF4-n	Allowed when: P-d\AEF2-n is FI	Specify the interval to be used to define the asynchronous embedded format locations.	
		Required when: Allowed		
		Range: 1 to value of P-d\MF1 minus 1		
WORD LENGTH	P-d\AEF5-n-w	Allowed when: P-d\AEF\N is greater than 0	Specify the number of embedded bits in this host word location.	
		Required when: Allowed		
		Range: 1 to size of word (either P-d\MFW2-n or P-d\F1)		
MASK	P-d\AEF6-n-w	Allowed when: P-d\AEF\N is greater than 0	If the asynchronous portion of the word is shorter than the word length, then provide the binary mask required to indicate which bits are used (1s used, 0s not used). Left-most bit corresponds to the msb.	
		Required when: P-d\AEF5-n-w is not the full word length		
		Range: 1 to size of word (either P-d\MFW2-n or P-d\F1) of 0,1		
SUB-COMMUTATED	P-d\AEF7-n-w	Allowed when: P-d\AEF\N is greater than 0	If this embedded format is not subcommutated (and appears in every minor frame), enter "NO"; otherwise, enter the number of definitions to follow, m.	
		Range: 0 to the number of minor frames or NO		
		Default: NO		

**Table 9-6. PCM Format Attributes Group (P)**

<b>Parameter</b>	<b>Code Name</b>	<b>Usage Attributes</b>	<b>Definition</b>
START FRAME	P-d\AEF8-n-w-m	Allowed when: P-d\AEF7-n-w is not NO	When the embedded format is subcommutated, enter the first minor frame number this embedded format appears in. If this field is missing, the default value “1” is assumed. Repeat P-d\AEF7-n-w number of times.
		Range: 1 to the number of minor frames	
		Default: 1	
FRAME INTERVAL	P-d\AEF9-n-w-m	Allowed when: P-d\AEF7-n-w is not NO	When the embedded format is subcommutated, enter the interval between minor frames that this embedded format appears in. If this field is missing, the default value “1” is assumed. Repeat P-d\AEF7-n-w number of times.
		Range: 0 to the number of minor frames	
		Default: 1	
<b>Format Change</b>			
<b>Frame Format Identifier</b>			
LOCATION	P-d\FFI1	Allowed when: P-d\DLN is specified	Specify the position in the minor frame that contains the frame format identification (FFI) word. If more than one word location, provide the details in the comments.
		Range: 1 to value of P-d\MF1 minus 1	
MASK	P-d\FFI2	Allowed when: P-d\FFI1 is specified	If the FFI is shorter than the word length, then provide the binary mask required to indicate which bits are used. Leftmost bit corresponds to the msb.
		Required when: Allowed	
		Range: 1 to size of word (either P-d\MFW2-n or P-d\F1) of 0,1	
<b>Measurement List Change</b>			
NUMBER OF MEASUREMENT LISTS	P-d\MLC\N	Allowed when: If P-d\FSC\N is 0	Specify the number of measurement lists that are required to be selected. If none, enter “NO”. Otherwise, enter the number, n.
		Range: 1-99, NO	
		Default: NO	
FFI PATTERN	P-d\MLC1-n	Allowed when: P-d\MLC\N is not NO	Specify the FFI pattern that corresponds to the measurement list (1s and 0s). This entry and the next are an ordered pair.
		Required when: Allowed	
		Range: 1 to the size of the word (either P-d\MFW2-n or P-d\F1) of 0,1	
MEASUREMENT LIST NAME	P-d\MLC2-n	Allowed when: P-d\MLC\N is not NO	Specify the measurement list name.
		Required when: Allowed	

**Table 9-6. PCM Format Attributes Group (P)**

Parameter	Code Name	Usage Attributes	Definition
		Links to: D-x\MLN-y	
		Range: 32 characters	
<b>Format Structure Change</b>			
NUMBER OF FORMATS	P-d\FSC\N	Allowed when: P-d\MLC\N is NO	Specify the number of formats to be defined.
		Range: 0-99	
		Default: 0	
FFI PATTERN	P-d\FSC1-n	Allowed when: P-d\FSC\N is specified	Specify the FFI pattern that corresponds to the format that is defined. This entry and the next are an ordered pair.
		Required when: Allowed	
		Range: 1 to the size of the word (either P-d\MFW2-n or P-d\F1) of 0,1	
DATA LINK ID	P-d\FSC2-n	Allowed when: P-d\FSC\N is specified	Identify the format that corresponds to this FFI code.
		Required when: Allowed	
		Links to: P-d\DLN	
		Range: 32 characters	
<b>Alternate Tag And Data</b>			
NUMBER OF TAGS	P-d\ALT\N	Allowed when: P-d\DLN specified	Specify the number of tag/data pairs to be included within the minor frame.
		Range: 0-999	
		Default: 0	
NUMBER OF BITS IN TAG	P-d\ALT1	Allowed when: if P-d\ALT\N is greater than 0	Specify the number of bits that are in the tag.
		Required when: Allowed	
		Range: Range 1 to the Size of word (P-d\F1)	
NUMBER OF BITS IN DATA WORD	P-d\ALT2	Allowed when: if P-d\ALT\N is greater than 0	Specify the number of bits that are in the common data word.
		Required when: Allowed	
		Range: Range 1 to the Size of word (P-d\F1)	

**Table 9-6. PCM Format Attributes Group (P)**

Parameter	Code Name	Usage Attributes	Definition	
FIRST TAG LOCATION	P-d\ALT3	Allowed when: if P-d\ALT\N is greater than 0	Identify the location of the start of the first tag location in terms of bits, with the first bit position after the synchronization pattern being number 1.	
		Required when: Allowed		
		Range: 1-16384		
SEQUENCE	P-d\ALT4	Allowed when: if P-d\ALT\N is greater than 0	If the tag/data word sequence is tag, then data enter “N” for normal. If the data precedes the tag, enter “R” for reversed.	
		Required when: Allowed		
		Range: Enumeration		
		Enumeration		Description
		N		Normal
		R		Reversed
<b>Asynchronous Data Merge Format</b>				
NUMBER OF ASYNCHRONOUS DATA MERGE FORMATS	P-d\ADM\N	Allowed when: P-d\DLN specified	Specify the number of asynchronous data merge formats.	
		Range: 0-99		
		Default: 0		
DATA MERGE NAME	P-d\ADM\DMN-n	Allowed when: P-d\ADM\N is not 0	Provide the data merge name for this asynchronous data merge format. This can be used to identify the source of the data merge format, as appropriate. Use the comments field to describe this data source for the asynchronous data merge format.	
		Required when: Allowed		
		Links to: P-d\DLN		
		Range: 32 characters		
MASK AND PATTERN	P-d\ADM\MP-n	Allowed when: P-d\ADM\N is not 0	If the asynchronous data merge format uses the overhead bits as recommended in <a href="#">Chapter 4</a> , enter “N”. Otherwise enter “Y” and specify the overhead mask and patterns. Default is “N” ( <a href="#">Chapter 4</a> ).	
		Range: Enumeration		
		Enumeration		Description
		N		No
		Y		Yes
		Default: N		
OVERHEAD MASK	P-d\ADM\OHM-n	Allowed when: P-d\ADM\MP-n is Y	If “MASK AND PATTERN” is “Y”, provide the mask of the overhead bits in binary. Right-most bit	
		Required when: Allowed		



**Table 9-6. PCM Format Attributes Group (P)**

Parameter	Code Name	Usage Attributes	Definition	
		Range: 1 to the size of word (either P-d\MFW2-n or P-d\F1) of 0,1	corresponds to the lsb.	
FRESH DATA PATTERN	P-d\ADM\FDP-n	Allowed when: P-d\ADM\MP-n is Y	If “MASK AND PATTERN” is “Y”, provide the pattern for fresh data in binary. Right-most bit corresponds to the lsb.	
		Required when: Allowed		
		Range: 1 to the size of word (either P-d\MFW2-n or P-d\F1) of 0,1		
DATA OVERFLOW PATTERN	P-d\ADM\DOP-n	Allowed when: P-d\ADM\MP-n is Y	If “MASK AND PATTERN” is “Y”, provide the pattern for data overflow in binary. Left-most bit corresponds to the msb.	
		Required when: Allowed		
		Range: 1 to the size of word (either P-d\MFW2-n or P-d\F1) of 0,1		
STALE DATA PATTERN	P-d\ADM\SDP-n	Allowed when: P-d\ADM\MP-n is Y	If “MASK AND PATTERN” is “Y”, provide the pattern for stale data in binary. Left-most bit corresponds to the msb.	
		Required when: Allowed		
		Range: 1 to the size of word (either P-d\MFW2-n or P-d\F1) of 0,1		
USER DEFINED PATTERN	P-d\ADM\UDP-n	Allowed when: P-d\ADM\MP-n is Y	If “MASK AND PATTERN” is “Y”, provide the pattern for user defined in binary. Left-most bit corresponds to the msb.	
		Required when: Allowed		
		Range: 1 to the size of word (either P-d\MFW2-n or P-d\F1) of 0,1		
SUPERCOM	P-d\ADM1-n	Allowed when: P-d\ADM\N is not 0	If the asynchronous data merge format is not supercommutated, enter “NO”. Otherwise, enter the number of host minor frame words that are used.	
		Required when: Allowed		
		Range: Range of 1 to P-d\MF1 minus 1 or NO		
LOCATION DEFINITION	P-d\ADM2-n	Allowed when: P-d\ADM\N is not 0	If supercommutated, specify how the word locations are defined.	
		Required when: Allowed		
		Range: Enumeration		
		Enumeration		Description
		FI		First word and interval
		EL		Every location

**Table 9-6. PCM Format Attributes Group (P)**

Parameter	Code Name	Usage Attributes		Definition
		CW	Contiguous words	
		NA	Not applicable	
LOCATION	P-d\ADM3-n-w	Allowed when: P-d\ADM\N is not 0		Specify the first word within the minor frame that contains the asynchronous data merge format identified. For the method when every word location is defined, repeat this entry for each word position applicable. For the first word and interval method, include the next entry to define the interval.
		Required when: Allowed		
		Range: Range of 1 to the value of P-d\MF1 minus 1		
INTERVAL	P-d\ADM4-n	Allowed when: If P-d\ADM2-n is FI		Specify the interval to be used to define the asynchronous data merge format locations.
		Required when: Allowed		
		Range: Range of 0 to the value of P-d\MF1 minus 1		
DATA LENGTH	P-d\ADM5-n	Allowed when: P-d\ADM\N is not 0		Specify the number of data bits used in this data merge format.
		Required when: Allowed		
		Range: 1 to the Size of word (P-d\F1)		
MSB LOCATION	P-d\ADM6-n	Allowed when: P-d\ADM\N is not 0		Provide the msb position within the host minor frame location.
		Required when: Allowed		
		Range: 1 to the Size of word (P-d\F1)		
PARITY	P-d\ADM7-n	Allowed when: P-d\ADM\N is not 0		If used, specify the parity information.
		Range: Enumeration		
		Enumeration	Description	
		EV	Even	
		OD	Odd	
		NO	None	
		Default: NO		
SUB-COMMUTATED	P-d\ADM8-n-w	Allowed when: P-d\ADM\N is not 0		If this data merge format is not subcommutated (and appears in every minor frame), enter "NO"; otherwise, enter the number of definitions to follow, m.
		Range: Range 0 to the size of subframe, NO		
		Default: NO		
START FRAME	P-d\ADM9-n-w-m	Allowed when: P-d\ADM8-n-w is not NO		When the data merge format is subcommutated, enter

**Table 9-6. PCM Format Attributes Group (P)**

Parameter	Code Name	Usage Attributes	Definition
		Range: 1 to the size of subframe Default: 1	the first minor frame number this data merge format appears in. If this field is missing, the default value “1” is assumed. Repeat m number of times.
FRAME INTERVAL	P-d\ADM10-n-w-m	Allowed when: P-d\ADM8-n-w is not NO Range: 0 to the size of subframe Default: 1	When the data merge format is subcommutated, enter the interval between minor frames that this data merge format appears in. If this field is missing, the default value “1” is assumed. Repeat m number of times.
<b>Chapter 7 Format</b>			
CHAPTER 7 NUMBER OF SEGMENTS	P-d\C7\N	R/R Ch 10 Status: RO Allowed when: P-d\DLN is specified Required when: Defining a Chapter 7 stream Range: 0 to the value of P-d\MF1 minus 1 Default: 0	If a Chapter 7 stream is defined, specify the number of Chapter 7 segments to be defined.
CHAPTER 7 FIRST WORD OF SEGMENT	P-d\C7FW-n	R/R Ch 10 Status: RO Allowed when: P-d\C7\N is not 0 Required when: Allowed Range: 1 to the value of P-d\MF1 minus 1	Specify the starting PCM word of the Chapter 7 segment. The first transmitted bit of this word is the first bit of the segment.
CHAPTER 7 NUMBER OF PCM WORDS IN SEGMENT	P-d\C7NW-n	R/R Ch 10 Status: RO Allowed when: P-d\C7\N is not 0 Required when: Allowed Range: 1 to the value of P-d\MF1 minus 1	Specify the number of PCM words used that the Chapter 7 segment occupies. An integral, packed number of Chapter 7 bytes is used. Any left-over (0-7) bits are ignored at the end.
<b>Comments</b>			
COMMENTS	P-d\COM	Allowed when: defining PCM Data	Provide the additional information requested or any other information desired.

9.5.7 PCM Measurement Description Attributes (D)

Figure 9-7 and Table 9-7 contain the PCM measurement descriptions. The descriptions define each measurand or data item of interest within the frame format specified in the PCM attributes. Table 9-7 includes the measurement name, which links the measurement to the Data Conversion Attributes group.

 <p><b>NOTE</b></p>	<p>Beginning with RCC IRIG 106-09, it is recommended that the “Word and Frame” location type be used instead of the other six traditional location types. Additionally, when using Word and Frame, it is recommended to avoid the use of subframes (as defined in the Subframe Definitions section of the PCM Format Attributes group in RCC IRIG 106-09 and previous releases) and locate measurements by word number and frame number within the major frame. As of the release of RCC IRIG 106-11, the other six location types and subframes have been removed.</p>
--	---

<b>Figure 9-7. PCM Measurement Description AttributesGroup (D)</b>		<b>Code Name</b>
<b>DATA LINK NAME - 9-114</b>		(D-x\DLN)
<a href="#">9-114</a>	NUMBER OF MEASUREMENT LISTS	(D-x\ML\N)
	MEASUREMENT LIST NAME	(D-x\MLN-y)
	NUMBER OF MEASURANDS	(D-x\MN\N-y)
	MEASUREMENT NAME	(D-x\MN-y-n)
<a href="#">9-115</a>	PARITY	(D-x\MN1-y-n)
	PARITY TRANSFER ORDER	(D-x\MN2-y-n)
	MEASUREMENT TRANSFER ORDER	(D-x\MN3-y-n)
	<b>*Measurement Location</b>	
<a href="#">9-116</a>	MEASUREMENT LOCATION TYPE	(D-x\LT-y-n)
	<b>*Word And Frame</b>	
	SUBFRAME ID COUNTER NAME	(D-x\IDCN-y-n)
	NUMBER OF MEASUREMENT LOCATIONS	(D-x\MML\N-y-n)
	NUMBER OF FRAGMENTS	(D-x\MNF\N-y-n-m)
	WORD POSITION	(D-x\WP-y-n-m-e)
	WORD INTERVAL	(D-x\WI-y-n-m-e)
	FRAME POSITION	(D-x\FP-y-n-m-e)
	FRAME INTERVAL	(D-x\FI-y-n-m-e)
	BIT MASK	(D-x\WFM-y-n-m-e)
	FRAGMENT TRANSFER ORDER	(D-x\WFT-y-n-m-e)
	FRAGMENT POSITION	(D-x\WFP-y-n-m-e)
	<b>*Simultaneous Sampling</b>	
	SAMPLING MODE	(D-x\SS-y-n)
SAMPLE ON	(D-x\SON-y-n)	
SAMPLE ON MEASUREMENT NAME	(D-x\SMN-y-n)	
NUMBER OF WORD FRAME SAMPLES	(D-x\SS\N-y-n)	
SAMPLE ON WORD	(D-x\SS1-y-n-s)	
SAMPLE ON FRAME	(D-x\SS2-y-n-s)	
OR	<b>*Tagged Data</b>	

<a href="#">9-120</a>		NUMBER OF TAG DEFINITIONS	(D-x\TD\N-y-n)
		TAG NUMBER	(D-x\TD2-y-n-m)
		BIT MASK	(D-x\TD3-y-n-m)
		FRAGMENT TRANSFER ORDER	(D-x\TD4-y-n-m)
		FRAGMENT POSITION	(D-x\TD5-y-n-m)
		<b>*Relative</b>	
		NUMBER OF PARENT MEASUREMENTS	(D-x\REL\N-y-n)
		PARENT MEASUREMENT	(D-x\REL1-y-n-m)
		BIT MASK	(D-x\REL2-y-n-m)
		FRAGMENT TRANSFER ORDER	(D-x\REL3-y-n-m)
		FRAGMENT POSITION	(D-x\REL4-y-n-m)
		<b>*Comments</b>	
		COMMENTS	(D-x\COM)
	<b>*Heading Only - No Data Entry</b>		

**Table 9-7. PCM Measurement Description Group (D)**

Parameter	Code Name	Usage Attributes	Definition	
DATA LINK NAME	D-x\DLN	Allowed when: P-d\DLN is specified and decommutation is required	Provide the data link name.	
		Required when: Allowed and defining CH10 non-throughput mode		
		Links from: P-d\DLN		
		Range: 32 characters		
NUMBER OF MEASUREMENT LISTS	D-x\ML\N	Allowed when: D-x\DLN is specified	Specify the number of measurement lists to be provided.	
		Required when: Allowed		
		Range: 1-99		
MEASUREMENT LIST NAME	D-x\MLN-y	Allowed when: D-x\DLN is specified	Provide the measurement list name associated with the following attributes. The following information will have to be repeated for each measurement list identified in the PCM Format Attributes group.	
		Required when: Allowed		
		Links from: P-d\MLC2-n		
		Range: 32 characters		
NUMBER OF MEASURANDS	D-x\MN\N-y	Allowed when: D-x\DLN is specified	Specify the number of measurands included within this measurement list.	
		Required when: Allowed		
		Range: 1-9999999		
MEASUREMENT NAME	D-x\MN-y-n	Allowed when: D-x\DLN is specified	Measurand name.	
		Required when: Allowed		
		Links to: C-d\DCN		
		Links from: D-x\REL1-y-n-m, R-x\SMF\SMN-n-m		
		Range: 32 characters		
PARITY	D-x\MN1-y-n	Allowed when: D-x\DLN is specified	Specify parity.	
		Range: Enumeration		
		Enumeration		Description
		EV		Even
		OD		Odd
		NO		None

**Table 9-7. PCM Measurement Description Group (D)**

<b>Table 9-7. PCM Measurement Description Group (D)</b>				
<b>Parameter</b>	<b>Code Name</b>	<b>Usage Attributes</b>		<b>Definition</b>
		DE	Minor frame default, as specified in PARITY (P-d\F3)	
		Default: DE		
PARITY TRANSFER ORDER	D-x\MN2-y-n	Allowed when: D-x\MN1-y-n is not NO		Parity bit location.
		Required when: Allowed		
		Range: Enumeration		
		Enumeration	Description	
		L	Leads measurement	
		T	Trails measurement	
		D	Minor frame default, as specified in PARITY TRANSFER ORDER (P-d\F4)	
MEASUREMENT TRANSFER ORDER	D-x\MN3-y-n	Allowed when: D-x\DLN specified		Measurement transfer order bit location.
		Range: Enumeration		
		Enumeration	Description	
		M	msb first	
		L	lsb first	
		D	Default, as specified in WORD TRANSFER ORDER, (P-d\F2)	
		Default: D		
<b>Measurement Location</b>				
MEASUREMENT LOCATION TYPE	D-x\LT-y-n	Allowed when: D-x\DLN specified		Specify the nature of the location of this measurand.
		Required when: Allowed		
		Range: Enumeration		
		Enumeration	Description	
		WDFR	Word and frame	
		TD	Tagged data	
		REL	Relative	

**Table 9-7. PCM Measurement Description Group (D)**

Parameter	Code Name	Usage Attributes	Definition
<b>Word And Frame</b>			
SUBFRAME ID COUNTER NAME	D-x\IDCN-y-n	Allowed when: D\LT is “WDFR”	Specify the subframe ID counter name (ISF1) that applies to this measurement (needed only if the PCM format contains multiple ID counters).
		Required when: Allowed	
		Range: 32 characters	
		Required when: When P\ISF\N > 1	
NUMBER OF MEASUREMENT LOCATIONS	D-x\MML\N-y-n	Allowed when: D\LT is “WDFR”	Specify the number of location definitions to follow for this measurement.
		Required when: Allowed	
		Range: 1-9999	
NUMBER OF FRAGMENTS	D-x\MNF\N-y-n-m	Allowed when: D\LT is “WDFR”	Number of word positions that each fragmented measurement location occupies. Enter “1” if this measurement is not fragmented.
		Required when: Allowed	
		Range: 1-8	
WORD POSITION	D-x\WP-y-n-m-e	Allowed when: D\LT is “WDFR”	Specify the minor frame word position of this measurement location or fragment.
		Required when: Allowed	
		Range: 1 to (P\MF1 minus 1)	
WORD INTERVAL	D-x\WI-y-n-m-e	Allowed when: D\LT is “WDFR”	Specify the interval that is the offset from the first word position and each subsequent word position. An interval of zero indicates that there is only one word position being defined.
		Range: 0 to (P\MF1 minus 2)	
		Default: 0	
FRAME POSITION	D-x\FP-y-n-m-e	Allowed when: D\LT is “WDFR”	Specify the frame location of this measurement location or fragment.
		Range: 1 - P\MF\N	
		Default: 1	
FRAME INTERVAL	D-x\FI-y-n-m-e	Allowed when: D\LT is “WDFR”	Specify the interval that is the offset from the first frame location and each subsequent frame location. An interval of zero indicates that there is only one frame location being defined.
		Range: 0 to (P\MF\N minus 1)	
		Default: 0	
BIT MASK	D-x\WFM-y-n-m-e	Allowed when: D\LT is “WDFR”	Binary string of 1s and 0s to identify the bit locations used in each measurement location or fragment. If the full word is used, enter “FW”. Left-most bit corresponds to the msb.
		Range: 1-64 of 0,1 or FW	
		Default: FW	



**Table 9-7. PCM Measurement Description Group (D)**

Parameter	Code Name	Usage Attributes	Definition	
FRAGMENT TRANSFER ORDER	D-x\WFT-y-n-m-e	Allowed when: $D \setminus MNF \setminus N > 1$	Measurement Transfer Order bit location.	
		Range: Enumeration		
		Enumeration		Description
		M		msb first
		L		lsb first
		D		Default, as specified in WORD TRANSFER ORDER (P-d\F2)
Default: D				
FRAGMENT POSITION	D-x\WFP-y-n-m-e	Allowed when: $D \setminus MNF \setminus N > 1$	A number from 1 to N specifying the position of this fragment within the reconstructed binary data word. 1 corresponds to the most significant fragment. Each fragment position from 1 to N must be specified only once.	
		Range: 1 - $D \setminus MNF \setminus N$		
		Default: 1		
<b>NOTE:</b> Measurement word length, fragment transfer order, and fragment position attributes do not apply when the “number of fragments” attribute for a measurement is 1.				
<b>Simultaneous Sampling</b>				
SAMPLING MODE	D-x\SS-y-n	Allowed when: D-x\DLN is specified	Specify the sampling mode. Default is Normal.	
		Range: Enumeration		
		Enumeration		Description
		N		Normal
		SS		Simultaneous Sample
Default: N				
SAMPLE ON	D-x\SON-y-n	Allowed when: D-x\SS-y-n is SS	Specify where the Simultaneous Sample occurs in the format. Choices are Measurement Name, Word/Frame, On Minor Frame, or On Major Frame.	
		Required when: Allowed		
		Range Enumeration		
		Enumeration		Description
		MN		Measurement
		WF		Word/Frame
MNF	On Minor Frame			

**Table 9-7. PCM Measurement Description Group (D)**

Parameter	Code Name	Usage Attributes		Definition
		MJF	On Major Frame	
SAMPLE ON MEASUREMENT NAME	D-x\SMN-y-n	Allowed when: When D-x\SON-y-n is MN		Measurement name for the measurement where the simultaneous sample occurs.
		Required when: Allowed		
		Range: 32 characters		
NUMBER OF WORD FRAME SAMPLES	D-x\SS\N-y-n	Allowed when: D-x\SON-y-n is WF		Number of Word/Frame pairs to follow.
		Required when: Allowed		
		Range: Positive Integer		
SAMPLE ON WORD	D-x\SS1-y-n-s	Allowed when: D-x\SON-y-n is WF		Word position where the simultaneous sample occurs.
		Required when: Allowed		
		Range: 1 to the value of P\MF1 minus 1		
SAMPLE ON FRAME	D-x\SS2-y-n-s	Allowed when: D-x\SON-y-n is WF		Frame position where the simultaneous sample occurs. If not specified, then simultaneous sampling occurs on every minor frame.
		Range: 1 to (P\MF\N-1)		
<b>Tagged Data</b>				
NUMBER OF TAG DEFINITIONS	D-x\TD\N-y-n	Allowed when: D\LT is "TD"		Specify the number of tag definitions, N. If not fragmented, enter "1".
		Required when: Allowed		
		Range: 1 to 9999		
TAG NUMBER	D-x\TD2-y-n-m	Allowed when: D\LT is "TD"		The expected tag number from the input data stream.
		Required when: Allowed		
		Range: 1 to 9999999999		
BIT MASK	D-x\TD3-y-n-m	Allowed when: D\LT is "TD"		Binary string of 1s and 0s to identify the bit locations in a word position that are assigned to this tagged data measurement. If the full word is used for this measurement, enter "FW". Left-most bit corresponds to the msb.
		Range: 1 to 64 of 0,1 or FW		
		Default: FW		
FRAGMENT TRANSFER ORDER	D-x\TD4-y-n-m	Allowed when: D\LT is "TD"		Fragment Transfer Order bit location.
		Range: Enumeration		
		Enumeration	Description	
		M	msb first	

**Table 9-7. PCM Measurement Description Group (D)**

Parameter	Code Name	Usage Attributes		Definition
		L	lsb first	
		D	Default, as specified in WORD TRANSFER ORDER (P-d\F2)	
		Default: D		
FRAGMENT POSITION	D-x\TD5-y-n-m	Allowed when: D\LT is “TD”		A number from 1 to N specifying the position of this fragment within the reconstituted binary data word. 1 corresponds to the most significant fragment. Each fragment position from 1 to N must be specified only once.
		Range: 1 - D\TD\N		
		Default: 1		
<b>Relative</b>				
NUMBER OF PARENT MEASUREMENTS	D-x\REL\N-y-n	Allowed when: D\LT is “REL”		Specify the number of parent measurements, N. If not fragmented, enter “1”.
		Required when: Allowed		
		Range: 1-9999999		
PARENT MEASUREMENT	D-x\REL1-y-n-m	Allowed when: D\LT is “REL”		If fragmented, all parent measurements must be at same data rate.
		Required when: Allowed		
		Links to: D-x\MN-y-n		
		Range: 32 characters		
BIT MASK	D-x\REL2-y-n-m	Allowed when: D\LT is “REL”		Binary string of 1s and 0s to identify the bit locations in a word position that are assigned to this relative measurement. If the full word is used for this measurement, enter “FW”. Leftmost bit corresponds to the msb.
		Range: 1-64 of 0,1 or FW		
		Default: FW		
FRAGMENT TRANSFER ORDER	D-x\REL3-y-n-m	Allowed when: D\LT is “REL”		Fragment Transfer Order bit location.
		Range: Enumeration		
		Enumeration	Description	
		M	msb first	
		L	lsb first	
		D	Default, as specified in WORD TRANSFER ORDER (P-d\F2)	

**Table 9-7. PCM Measurement Description Group (D)**

Parameter	Code Name	Usage Attributes	Definition
		Default: D	
FRAGMENT POSITION	D-x\REL4-y-n-m	Allowed when: D\LT is "REL"	A number from 1 to N specifying the position of this fragment within the reconstituted binary data word. 1 corresponds to the most significant fragment. Each fragment position from 1 to N must be specified only once.
		Range: 1-D\REL\N	
		Default: 1	
<b>Comments</b>			
COMMENTS	D-x\COM	Allowed when: D-x\DLN specified	Provide the additional information requested or any other information desired.
		Range: 3200 characters	
<p><b>NOTE:</b> This group will contain a repetition of the above information until each measurement has been defined. Any word position not included will be treated as a spare channel or a "don't care" channel. Information will not be processed for these "spare" channels. Note that measurement list changes and format changes that are a part of class II systems are included in the above, since the key to the measurement definition is the data link name (format) and the measurement list.</p>			

## 9.5.8 Bus Data Attributes (B)

[Figure 9-8](#) and [Table 9-8](#) describe bus-originated data formats. The Bus Data Attributes group defines the attributes of a MIL-STD-1553 data acquisition system that is compliant with [Chapter 8](#) or an ARINC 429 data acquisition system that is consistent with the specification of ARINC 429 bus data. The primary components of this group are the recording description and message content definition. The former defines the method by which the data were recorded on the tape such as track spread versus composite. The latter consists of the message identification information and the measurement description set. The message identification information defines the contents of the control word that identifies each bus message. The measurement description set describes the measurement attributes and contains the measurement name that links the measurand to the Data Conversion Attributes group (C).

Mode codes are described in the message identification information. If the Subterminal Address field contains 00000 or 11111, the information in the Data Word Count/Mode Code field is a mode code and identifies the function of the mode code. If the mode code has associated data words, they are described in this section of the attributes. If the bus message is a remote terminal to remote terminal transfer, both the transmit command and the receive command are used to identify the message.

<b>Figure 9-8. Bus Data Attributes Group (B)</b>		<b>Code Name</b>
<b>DATA LINK NAME - <a href="#">9-123</a></b>		(B-x\DLN)
	TEST ITEM	(B-x\TA)
	BUS PARITY	(B-x\BP)
	NUMBER OF BUSES	(B-x\NBS\N)
	BUS NUMBER	(B-x\BID-i)
	BUS NAME	(B-x\BNA-i)
	BUS TYPE	(B-x\BT-i)
	<b>* User-Defined Words</b>	
	USER-DEFINED WORD 1 MEASUREMENT	(B-x\UMN1-i)
	PARITY	(B-x\U1P-i)
	PARITY TRANSFER ORDER	(B-x\U1PT-i)
	BIT MASK	(B-x\U1M-i)
	TRANSFER ORDER	(B-x\U1T-i)
	USER-DEFINED WORD 2 MEASUREMENT	(B-x\UMN2-i)
	PARITY	(B-x\U2P-i)
	PARITY TRANSFER ORDER	(B-x\U2PT-i)
	BIT MASK	(B-x\U2M-i)
	TRANSFER ORDER	(B-x\U2T-i)
	USER-DEFINED WORD 3 MEASUREMENT	(B-x\UMN3-i)
	PARITY	(B-x\U3P-i)
	PARITY TRANSFER ORDER	(B-x\U3PT-i)
	BIT MASK	(B-x\U3M-i)
	TRANSFER ORDER	(B-x\U3T-i)
<a href="#">9-127</a>	<b>*Recording Description</b>	
	NUMBER OF TRACKS	(B-x\TK\N-i)
	TRACK SEQUENCE	(B-x\TS-i-k)

<a href="#">9-127</a>	<b>*Message Content Definition</b>	
	NUMBER OF MESSAGES	(B-x\NMS\N-i)
	MESSAGE NUMBER	(B-x\MID-i-n)
	MESSAGE NAME	(B-x\MNA-i-n)
	COMMAND WORD ENTRY	(B-x\CWE-i-n)
	COMMAND WORD	(B-x\CMD-i-n)
	REMOTE TERMINAL NAME	(B-x\TRN-i-n)
	REMOTE TERMINAL ADDRESS	(B-x\TRA-i-n)
	SUBTERMINAL NAME	(B-x\STN-i-n)
	SUBTERMINAL ADDRESS	(B-x\STA-i-n)
	TRANSMIT/RECEIVE MODE	(B-x\TRM-i-n)
	DATA WORD COUNT/MODE CODE	(B-x\DWC-i-n)
	SPECIAL PROCESSING	(B-x\SPR-i-n)
<a href="#">9-129</a>	<b>*ARINC 429 Message Definition</b>	
	ARINC 429 LABEL	(B-x\LBL-i-n)
	ARINC 429 SDI CODE	(B-x\SDI-i-n)
<a href="#">9-129</a>	<b>*RT/RT Receive Command List</b>	
	RECEIVE COMMAND WORD ENTRY	(B-x\RCWE-i-n)
	RECEIVE COMMAND WORD	(B-x\RCMD-i-n)
	REMOTE TERMINAL NAME	(B-x\RTRN-i-n)
	REMOTE TERMINAL ADDRESS	(B-x\RTRA-i-n)
	SUBTERMINAL NAME	(B-x\RSTN-i-n)
	SUBTERMINAL ADDRESS	(B-x\RSTA-i-n)
	DATA WORD COUNT	(B-x\RDWC-i-n)
<a href="#">9-130</a>	<b>*Mode Code</b>	
	MODE CODE DESCRIPTION	(B-x\MCD-i-n)
	MODE CODE DATA WORD DESCRIPTION	(B-x\MCW-i-n)
<a href="#">9-131</a>	<b>*Measurement Description Set</b>	
	NUMBER OF MEASURANDS	(B-x\MN\N-i-n)
	MEASUREMENT NAME	(B-x\MN-i-n-p)
	MEASUREMENT TYPE	(B-x\MT-i-n-p)
	PARITY	(B-x\MN1-i-n-p)
	PARITY TRANSFER ORDER	(B-x\MN2-i-n-p)
<a href="#">9-132</a>	<b>*Measurement Location</b>	
	NUMBER OF MEASUREMENT LOCATIONS	(B-x\NML\N-i-n-p)
	MESSAGE WORD NUMBER	(B-x\MWN-i-n-p-e)
<a href="#">9-132</a>	BIT MASK	(B-x\MBM-i-n-p-e)
	TRANSFER ORDER	(B-x\MTO-i-n-p-e)
	FRAGMENT POSITION	(B-x\MFP-i-n-p-e)
	<b>*Comments</b>	
<a href="#">9-133</a>	COMMENTS	(B-x\COM)
*Heading Only - No Data Entry		

**Table 9-8. Bus Data Attributes Group (B)**

Parameter	Code Name	Usage Attributes	Definition	
DATA LINK NAME	B-x\DLN	Allowed when: defining bus data	Identify the data link name consistent with the Multiplex/Modulation group. The PCM format of the data stream shall be defined in the PCM Format Attributes group.	
		Required when: Allowed		
		Links from: R-x\CDLN, P-d\DLN, R-x\EV\DLN-n		
		Range: 32 characters		
TEST ITEM	B-x\TA	Allowed when: B\DLN is specified	Test item description in terms of name, model, platform, or identification code that contains the data acquisition system.	
		Range: 16 characters		
BUS PARITY	B-x\BP	Allowed when: B\DLN is specified	Specify whether the msb of the 1553 words is a parity bit. If parity is used, it must be odd parity, as specified in <a href="#">Chapter 8</a> , Paragraph 8.2.2.	
		Required when: Allowed		
		Range: Enumeration		
		Enumeration		Description
		OD		Odd
NO	None			
NUMBER OF BUSES	B-x\NBS\N	Allowed when: B\DLN is specified	Specify the number of buses included within this data link. If parity is used, the maximum is 8 buses, and if parity is not used, the maximum is 16 buses, as specified in <a href="#">Chapter 8</a> , Paragraph 8.2.3.	
		Required when: Allowed		
		Range: 1-16		
BUS NUMBER	B-x\BID-i	Allowed when: B\DLN is specified	Enter the bus number as a binary string.	
		Required when: Allowed		
		Range: Binary		
BUS NAME	B-x\BNA-i	Allowed when: B\DLN is specified	Specify the bus name.	
		Range: 32 characters		
BUS TYPE	B-x\BT-i	Allowed when: B\DLN is specified	Specify the bus type.	
		Required when: Allowed		
		Range: Enumeration		
		Enumeration		Description
		1553		1553 bus
A429	ARINC 429 bus			

**Table 9-8. Bus Data Attributes Group (B)**

Parameter	Code Name	Usage Attributes	Definition	
<b>User-Defined Words</b>				
USER-DEFINED WORD 1 MEASUREMENT	B-x\UMN1-i	Allowed when: defining Chapter 8 bus data and using content ID label 0010	Specify the measurement name associated with the content ID label (bits 5-8) value of “0010”.	
		Links to: C-d\DCN		
		Range: 32 characters		
PARITY	B-x\U1P-i	Allowed when: B-x\UMN1-i is specified	Specify parity.	
		Range: Enumeration		
		Enumeration		Description
		EV		Even
		OD		Odd
		NO		None
Default: NO				
PARITY TRANSFER ORDER	B-x\U1PT-i	Allowed when: B\U1P is not “NO”	Parity bit location.	
		Required when: Allowed		
		Range: Enumeration		
		Enumeration		Description
		L		Leads word
T	Trails word			
BIT MASK	B-x\U1M-i	Allowed when: B-x\UMN1-i is specified	Binary string of 1s and 0s to identify the bit locations that are assigned to this measurement in the word identified above. If the full word is used for this measurement, enter “FW”. Left-most bit corresponds to the msb.	
		Range: Binary or “FW”		
		Default: FW		
TRANSFER ORDER	B-x\U1T-i	Allowed when: B-x\UMN1-i is specified	Transfer Order bit location.	
		Range: Enumeration		
		Enumeration		Description
		MSB		msb first
		LSB		lsb first
DEF	Default as specified in WORD TRANSFER ORDER (P-d\F2)			



**Table 9-8. Bus Data Attributes Group (B)**

Parameter	Code Name	Usage Attributes	Definition	
		Default: MSB		
USER-DEFINED WORD 2 MEASUREMENT	B-x\UMN2-i	Allowed when: defining Chapter 8 bus data and using content ID label 0011	Specify the measurement name associated with the content ID label (bits 5-8) value of “0011”.	
		Links to: C-d\DCN		
		Range: 32 characters		
PARITY	B-x\U2P-i	Allowed when: B-x\UMN2-i is specified	Specify parity.	
		Range: Enumeration		
		Enumeration		Description
		EV		Even
		OD		Odd
		NO		None
PARITY TRANSFER ORDER	B-x\U2PT-i	Allowed when: B\U2P is not “NO”	Parity bit location.	
		Required when: Allowed		
		Range: Enumeration		
		Enumeration		Description
		L		Leads word
		T		Trails word
BIT MASK	B-x\U2M-i	Allowed when: B-x\UMN2-i is specified	Binary string of 1s and 0s to identify the bit locations that are assigned to this measurement in the word identified above. If the full word is used for this measurement, enter “FW”. Left-most bit corresponds to the msb.	
		Range: Binary or “FW”		
		Default: FW		
TRANSFER ORDER	B-x\U2T-i	Allowed when: B-x\UMN2-i is specified	Transfer Order bit location.	
		Range: Enumeration		
		Enumeration		Description
		MSB		msb first
		LSB	lsb first	

**Table 9-8. Bus Data Attributes Group (B)**

Parameter	Code Name	Usage Attributes		Definition
		DEF	Default as specified in WORD TRANSFER ORDER (P-d\F2)	
		Default: MSB		
USER-DEFINED WORD 3 MEASUREMENT	B-x\UMN3-i	Allowed when: defining Chapter 8 bus data and using content ID label 0100		Specify the measurement name associated with the content ID label (bits 5-8) value of “0100” (valid only for 1553, when response time is not used).
		Links to: C-d\DCN		
		Range: 32 characters		
PARITY	B-x\U3P-i	Allowed when: B-x\UMN3-i is specified		Specify parity.
		Range: Enumeration		
		Enumeration	Description	
		EV	Even	
		OD	Odd	
		NO	None	
Default: NO				
PARITY TRANSFER ORDER	B-x\U3PT-i	Allowed when: B\U3P is not “NO”		Parity bit location.
		Required when: Allowed		
		Range: Enumeration		
		Enumeration	Description	
		L	Leads word	
T	Trails word			
BIT MASK	B-x\U3M-i	Allowed when: B-x\UMN3-i is specified		Binary string of 1s and 0s to identify the bit locations that are assigned to this measurement in the word identified above. If the full word is used for this measurement, enter “FW”. Left-most bit corresponds to the msb.
		Range: Binary or “FW”		
		Default: FW		
TRANSFER ORDER	B-x\U3T-i	Allowed when: B-x\UMN3-i is specified		Transfer Order bit location.
		Range: Enumeration		
		Enumeration	Description	
		MSB	msb first	

**Table 9-8. Bus Data Attributes Group (B)**

<b>Table 9-8. Bus Data Attributes Group (B)</b>				
<b>Parameter</b>	<b>Code Name</b>	<b>Usage Attributes</b>		<b>Definition</b>
		LSB	lsb first	
		DEF	Default as specified in WORD TRANSFER ORDER (P-d\F2)	
		Default: MSB		
<b>Recording Description</b>				
NUMBER OF TRACKS	B-x\TK\N-i	Allowed when: B\DLN specified		Enter the number of tape tracks used to record data. Any entry greater than one indicates that the data has been spread across multiple tracks.
		Range: Non-Negative Integer		
		Default: 0		
TRACK SEQUENCE	B-x\TS-i-k	Allowed when: B\TK\N > 1		In these entries, give the sequence order of tape tracks that should be used to recover the data stream in the correct order. The order given should correspond to the actual skew of the data on the tape.
		Required when: Allowed		
		Range: Positive Integer		
<b>Message Content Definition</b>				
NUMBER OF MESSAGES	B-x\NMS\N-i	Allowed when: B\TK\N > 1		The number of messages to be defined.
		Required when: Allowed		
		Range: Positive Integer		
MESSAGE NUMBER	B-x\MID-i-n	Allowed when: B\TK\N > 1		The message number that contains the following data.
		Range: Positive Integer		
MESSAGE NAME	B-x\MNA-i-n	Allowed when: B\TK\N > 1		Specify the message name.
COMMAND WORD ENTRY	B-x\CWE-i-n	Allowed when: dB-x\BT-I is 1553		Method used to specify the command word.
		Range: Enumeration		
		Enumeration	Description	
		W	Enter the entire command word in the COMMAND WORD attribute	

**Table 9-8. Bus Data Attributes Group (B)**

Parameter	Code Name	Usage Attributes		Definition
		F	Enter command word fields separately in the REMOTE TERMINAL ADDRESS, SUBTERMINAL ADDRESS, TRANSMIT/RECEIVE MODE, and DATA WORD COUNT/MODE CODE attributes	
		Default: F		
COMMAND WORD	B-x\CMD-i-n	Allowed when: B-x\CWE-i-n is "W"		Specify the entire command word for this message.
		Required when: Allowed		
		Range: Hexadecimal		
REMOTE TERMINAL NAME	B-x\TRN-i-n	Allowed when: B-x\CWE-i-n is "F"		Enter the name of the remote terminal that is sending or receiving this message. For RT/RT, specify the sending remote terminal name.
		Range: 32 characters		
REMOTE TERMINAL ADDRESS	B-x\TRA-i-n	Allowed when: B-x\CWE-i-n is "F"		Specify the five-bit remote terminal address for this message.
		Required when: Allowed		
		Range: Binary		
SUBTERMINAL NAME	B-x\STN-i-n	Allowed when: B-x\CWE-i-n is "F"		Enter the name of the subterminal that is sending or receiving this message.
		Range: 32 characters		
SUBTERMINAL ADDRESS	B-x\STA-i-n	Allowed when: B-x\CWE-i-n is "F"		Specify the five-bit subterminal address for this message. Use "X" to indicate a "don't care" value.
		Required when: Allowed		
		Range: Binary pattern of 5		
TRANSMIT/RECEIVE MODE	B-x\TRM-i-n	Allowed when: B-x\CWE-i-n is "F"		Indicate if this command word is a transmit or receive command. For RT/RT, specify transmit.
		Required when: Allowed		
		Range: Enumeration		
		Enumeration	Description	
		1	Transmit	
0	Receive			

**Table 9-8. Bus Data Attributes Group (B)**

<b>Parameter</b>	<b>Code Name</b>	<b>Usage Attributes</b>		<b>Definition</b>
DATA WORD COUNT/MODE CODE	B-x\DWC-i-n	Allowed when: B-x\CWE-i-n is "F"		Enter the number of data words as a binary string, using "X" to indicate a "don't care" value. If the subterminal address indicates a mode code, enter the mode code value as a binary string.
		Required when: Allowed		
		Range: Binary pattern of 5		
SPECIAL PROCESSING	B-x\SPR-i-n	Allowed when: B\DLN is specified		Provide any special processing requirements pertaining to this message.
		Range: 200 characters		
<b>ARINC 429 Message Definition</b>				
ARINC 429 LABEL	B-x\LBL-i-n	Allowed when: B-x\BT-i is "A429"		Specify the eight-bit ARINC 429 label for this message.
		Required when: Allowed		
		Range: 8 Binary digits		
ARINC 429 SDI CODE	B-x\SDI-i-n	Allowed when: B-x\BT-i is "A429"		Specify the two-bit ARINC 429 SDI code for this message.
		Required when: Allowed		
		Range: Enumeration		
		Enumeration	Description	
		ALL	All SDI	
		0	SDI code 0	
		1	SDI code 1	
		2	SDI code 2	
3	SDI code 3			
<b>RT/RT Receive Command List</b>				
RECEIVE COMMAND WORD ENTRY	B-x\RCWE-i-n	Allowed when: B\DLN is specified		Method used to specify the receive command word. Default is "F".
		Range: Enumeration		
		Enumeration	Description	
		W	Enter the entire command word in the RECEIVE COMMAND WORD attribute.	

**Table 9-8. Bus Data Attributes Group (B)**

Parameter	Code Name	Usage Attributes	Definition
		F Enter the command word fields separately in the REMOTE TERMINAL ADDRESS, SUBTERMINAL ADDRESS, and DATA WORD COUNT attributes.	
RECEIVE COMMAND WORD	B-x\RCMD-i-n	Allowed when: B-x\RCWE-i-n is "W" Required when: Allowed Range: Hexadecimal	Specify the entire receive command word for this RT/RT message.
REMOTE TERMINAL NAME	B-x\RTRN-i-n	Allowed when: B-x\RCWE-i-n is "F" Range: 32 characters	Enter the name of the remote terminal that is receiving this RT/RT message.
REMOTE TERMINAL ADDRESS	B-x\RTRA-i-n	Allowed when: B-x\RCWE-i-n is "F" Required when: Allowed Range: Binary	Specify the five-bit remote terminal address for this RT/RT message.
SUBTERMINAL NAME	B-x\RSTN-i-n	Allowed when: B-x\RCWE-i-n is "F" Range: 32 characters	Enter the name of the sub-terminal that is receiving this RT/RT message.
SUBTERMINAL ADDRESS	B-x\RSTA-i-n	Allowed when: B-x\RCWE-i-n is "F" Required when: Allowed Range: Binary Pattern of 5	Specify the five-bit subterminal address for this RT/RT message. Use "X" to indicate a "don't care" value.
DATA WORD COUNT	B-x\RDWC-i-n	Allowed when: B-x\RCWE-i-n is "F" Required when: Allowed Range: Binary Pattern of 5	Enter the number of data words as a binary string, using "X" to indicate a "don't care" value. Exclude status and time words. An RT/RT message cannot contain a mode code.
<b>Mode Code</b>			
MODE CODE DESCRIPTION	B-x\MCD-i-n	Allowed when: B-x\DWC-i-n is 00000 or 11111 Range: 200 characters	Describe the function or action associated with this mode code.
MODE CODE DATA WORD DESCRIPTION	B-x\MCW-i-n	Allowed when: B-x\DWC-i-n is 00000 or 11111 Range: 200 characters	If the mode code has an associated data word following the mode code command, provide a complete description of the data word.

**Table 9-8. Bus Data Attributes Group (B)**

Parameter	Code Name	Usage Attributes	Definition	
<b>Measurement Description Set</b>				
NUMBER OF MEASURANDS	B-x\MN\N-i-n	Allowed when: B\DLN is specified	Specify the number of measurands.	
		Required when: Allowed		
		Range: Positive Integer		
MEASUREMENT NAME	B-x\MN-i-n-p	Allowed when: B\DLN is specified	Measurand name.	
		Required when: Allowed		
		Links to: C-d\DCN		
		Links from: R-x\BME\SMN-n-m		
		Range: 32 characters		
MEASUREMENT TYPE	B-x\MT-i-n-p	Allowed when: B\DLN is specified	Content identification.	
		Required when: Allowed		
		Range: Enumeration		
		Enumeration		Description
		D		Data word
		C		Command word
		S		Status word
		T		Time word
PARITY	B-x\MN1-i-n-p	Allowed when: B\DLN is specified	Specify parity.	
		Status: Optional		
		Range: Enumeration		
		Enumeration		Description
		EV		Even
		OD		Odd
		NO		None
		Default: NO		
PARITY TRANSFER ORDER	B-x\MN2-i-n-p	Allowed when: B\MN1 is not "NO"	Parity bit location.	
		Required when: Allowed		
		Range: Enumeration		

		Enumeration	Description	
		L	Leads word	
		T	Trails word	
Measurement Location				
NUMBER OF MEASUREMENT LOCATIONS	B-x\NML\N-i-n-p	Allowed when: B\DLN is specified		If this measurement is contained in one word, enter "1". If this measurement is fragmented, enter the number of fragments.
		Required when: Allowed		
		Range: 1-8		
MESSAGE WORD NUMBER	B-x\MWN-i-n-p-e	Allowed when: B\DLN is specified		Enter the data word number within a message that contains the measurement or the fragmented measurand.
		Required when: Allowed		
		Range: Positive Integer		
BIT MASK	B-x\MBM-i-n-p-e	Allowed when: B\DLN is specified		Binary string of 1s and 0s to identify the bit locations that are assigned to this measurement in the word identified above. If the full word is used for this measurement, enter "FW". Left-most bit corresponds to the msb.
		Range: Binary or "FW"		
		Default: FW		
TRANSFER ORDER	B-x\MTO-i-n-p-e	Allowed when: B\DLN is specified		Bit transfer order for the measurement.
		Range: Enumeration		
		Enumeration	Description	
		MSB	msb first.	
		LSB	lsb bit first.	
		DEF	Default as specified in WORD TRANSFER ORDER (P-d\F2).	
		Default: MSB		
FRAGMENT POSITION	B-x\MFP-i-n-p-e	Allowed when: B\DLN is specified		A number from 1 to N specifying the position of this fragment within the reconstructed binary data word. 1 corresponds to the most significant fragment. Each fragment position from 1 to N must be specified only once.
		Range: 1-8		
		Required when: B\NML\N is greater than 1		
<b>NOTE:</b> Repeat the above to describe each fragment of a fragmented word. The transfer order indicates whether to transpose the order of the bit sequence or not (lsb indicates to transpose the bit sequence).				



Comments			
COMMENTS	B-x\COM	Allowed when: B\DLN is specified	Provide the additional information requested or other information desired.
		Range: 3200 characters	

9.5.9 Message Data Attributes (S)

The Message Data Attributes are presented graphically in [Figure 9-9](#) and specified in [Table 9-9](#). The information contained within this group is used to describe the characteristics and measurement locations within data streams as described by the UART, Message, Ethernet, IEEE-1394, and Fibre Channel Chapter 10 channel data types.

<b>Figure 9-9. Message Data Attributes Group (S)</b>		<b>Code Name</b>	
	<b>DATA LINK NAME - <a href="#">9-136</a></b>	(S-d\DLN)	
	TEST ITEM	(S-d\TA)	
	NUMBER OF STREAMS	(S-d\NS\N)	
<a href="#">9-138</a>	STREAM NAME	(S-d\SNA-i)	
	MESSAGE DATA TYPE	(S-d\MDT-i)	
	MESSAGE DATA LAYOUT	(S-d\MDL-i)	
	MESSAGE ELEMENT SIZE	(S-d\MES-i)	
	MESSAGE ID LOCATION	(S-d\MIDL-i)	
	MESSAGE LENGTH	(S-d\MLEN-i)	
	MESSAGE DELIMITER	(S-d\MDEL-i)	
	MESSAGE DELIMITER LENGTH	(S-d\MDLEN-i)	
	NUMBER OF FIELD DELIMITERS	(S-d\NFDEL\N-i)	
	FIELD DELIMITER	(S-d\FDEL-i-n)	
	DATA ORIENTATION	(S-d\DO-i)	
		<b>*Message Content Definition</b>	
	<a href="#">9-138</a>	NUMBER OF MESSAGES	(S-d\NMS\N-i)
MESSAGE ID		(S-d\MID-i-n)	
MESSAGE DESCRIPTION		(S-d\MNA-i-n)	
NUMBER OF FIELDS		(S-d\NFLDS\N-i-n)	
FIELD NUMBER		(S-d\FNUM-i-n-m)	
FIELD START		(S-d\FPOS-i-n-m)	
FIELD LENGTH		(S-d\FLEN-i-n-m)	
	<b>*Measurement Description Set</b>		
<a href="#">9-140</a>	NUMBER OF MEASURANDS	(S-d\MN\N-i-n)	
	MEASUREMENT NAME	(S-d\MN-i-n-p)	
	PARITY	(S-d\MN1-i-n-p)	
	PARITY TRANSFER ORDER	(S-d\MN2-i-n-p)	
	DATA TYPE	(S-d\MBFM-i-n-p)	
	FLOATING POINT FORMAT	(S-d\MFPF-i-n-p)	
DATA ORIENTATION	(S-d\MDO-i-n-p)		
	<b>*Measurement Location</b>		
<a href="#">9-141</a>	NUMBER OF MEASUREMENT LOCATIONS	(S-d\NML\N-i-n-p)	
	MESSAGE FIELD NUMBER	(S-d\MFN-i-n-p-e)	
	BIT MASK	(S-d\MBM-i-n-p-e)	
	TRANSFER ORDER	(S-d\MTO-i-n-p-e)	
	FRAGMENT POSITION	(S-d\MFP-i-n-p-e)	
<a href="#">9-141</a>	<b>*Comments</b>		

		COMMENTS	(S-d\COM)
*Heading Only - No Data Entry			

**Table 9-9. Message Data Attributes Group (S)**

Parameter	Code Name	Usage Attributes	Definition	
DATA LINK NAME	S-d\DLN	Allowed when: R\CDT is either “UARTIN” or “MSGIN” or “ETHIN” or “FBCHIN”	Identify the data link name consistent with the Recorder-Reproducer group.	
		Required when: Allowed		
		Links from: R-x\CDLN, R-x\EV\DLN-n		
		Range: 32 characters		
TEST ITEM	S-d\TA	Allowed when: S\DLN is specified	Test item description in terms of name, model, platform, or identification code that contains the data acquisition system.	
		Range: 16 characters		
NUMBER OF STREAMS	S-d\NS\N	Allowed when: S\DLN is specified	Specify the number of message data streams included within this data link.	
		Required when: Allowed		
		Range: 2 characters		
STREAM NAME	S-d\SNA-i	Allowed when: S\DLN is specified	Specify the message data stream name (subchannel name or same as data link name if no subchannel).	
		Required when: Allowed		
		Range: 32 characters		
MESSAGE DATA TYPE	S-d\MDT-i	Allowed when: S\DLN is specified	Data type - “ASCII” or “BINARY”.	
		Range: Enumeration		
		Enumeration		Description
		ASCII		
		BINARY		
		Default: ASCII		
MESSAGE DATA LAYOUT	S-d\MDL-i	Allowed when: S\DLN is specified	Specify message data layout.	
		Required when: Allowed		
		Range: Enumeration		
		Enumeration		Description
		DELIMITED		Data layout [ASCII data type only]
		FIXED		ASCII or binary data types.

**Table 9-9. Message Data Attributes Group (S)**

Parameter	Code Name	Usage Attributes	Definition	
MESSAGE ELEMENT SIZE	S-d\MES-i	Allowed when: S\DLN is specified	Element size in number of bits.	
		Required when: Allowed		
		Range: 2 characters		
		Default: 8		
MESSAGE ID LOCATION	S-d\MIDL-i	Allowed when: S\DLN is specified	Message ID field number.	
		Required when: Allowed		
		Range: 4 characters		
MESSAGE LENGTH	S-d\MLEN-i	Allowed when: S-d\MDL-I is "FIXED"	Message length in number of message elements (fixed data layout only).	
		Required when: Allowed		
		Range: 8 characters		
MESSAGE DELIMITER	S-d\MDEL-i	Allowed when: S-d\MDL-I is "DELIMITED"	Message delimiter - "CRLF" or "CR" or "LF" or hex value (delimited layout only).	
		Required when: Allowed		
		Range: Hex or Enums		
MESSAGE DELIMITER LENGTH	S-d\MDLEN-i	Allowed when: S-d\MDL-I is "DELIMITED"	Message delimiter length in number of message elements (delimited layout only).	
		Required when: Allowed		
		Range: 2 characters		
NUMBER OF FIELD DELIMITERS	S-d\NDFEL\N-i	Allowed when: S-d\MDL-I is "DELIMITED"	Number of delimiters defined (delimited layout only)	
		Required when: Allowed		
		Range: 2 characters		
FIELD DELIMITER	S-d\FDEL-i-n	Allowed when: S-d\MDL-I is "DELIMITED"	Field delimiter - ",", or " ", or "blank" or "tab", or hex value (delimited layout only).	
		Required when: Allowed		
		Range: Hex or Enums		
<b>NOTE:</b> A field is a set of elements determined by the number of elements or elements between field delimiters. A message consists of one or more fields, which can be fixed or variable length.				
DATA ORIENTATION	S-d\DO-i	Allowed when: S-d\MDT-I = "BINARY".	Data orientation. Binary data type only.	
		Range: Enumeration		
		Enumeration		Description
		L		Little endian
		B		Big endian

**Table 9-9. Message Data Attributes Group (S)**

Parameter	Code Name	Usage Attributes	Definition
		Default: Big Endian	
<b>Message Content Definition</b>			
NUMBER OF MESSAGES	S-d\NMS\N-i	Allowed when: S\DLN is specified	The number of messages to be defined.
		Required when: Allowed	
		Range: 8 characters	
MESSAGE ID	S-d\MID-i-n	Allowed when: S-d\MIDL-I is not “0”	Message ID value. ASCII value in quotes or hex value.
		Required when: Allowed	
		Range: ASCII or Hex	
MESSAGE DESCRIPTION	S-d\MNA-i-n	Allowed when: S-d\MIDL-I is not “0”	Message description.
		Range: 64 characters	
NUMBER OF FIELDS	S-d\NFLDS\N-i-n	Allowed when: S-d\MIDL-I is not “0”	Number of fields in the message.
		Required when: Allowed	
		Range: 4 characters	
FIELD NUMBER	S-d\FNUM-i-n-m	Allowed when: S-d\MIDL-I is not “0”	Specify the field number.
		Required when: Allowed	
		Range: 4 characters	
FIELD START	S-d\FPOS-i-n-m	Allowed when: S-d\MDL-I is “FIXED”	Enter the element position of the field (only for fixed column message data layout).
		Required when: Allowed	
		Range: 5 characters	
FIELD LENGTH	S-d\FLEN-i-n-m	Allowed when: S-d\MDL-I is “FIXED”	Enter the field length (only for fixed message data layout). If message data type is ASCII, ASCII string in field is converted to specified data type, i.e., float. If message data type is binary, field is cast as specified data type, i.e., unsigned, signed, float, ASCII, etc.
		Required when: Allowed	
		Range: 5 characters	
<b>Measurement Description Set</b>			
NUMBER OF MEASURANDS	S-d\MN\N-i-n	Allowed when: S\DLN is specified	Specify the number of measurands.
		Range: 4 characters	
MEASUREMENT NAME	S-d\MN-i-n-p	Allowed when: S\MN\N > 0	Measurand name.
		Links to: C-d\DCN	

**Table 9-9. Message Data Attributes Group (S)**

Parameter	Code Name	Usage Attributes		Definition
		Range: 32 characters		
PARITY	S-d\MN1-i-n-p	Allowed when: S\MN\N > 0		Normal word parity.
		Range: Enumeration		
		Enumeration	Description	
		EV	Even	
		OD	Odd	
		NO	None	
Default: NO				
PARITY TRANSFER ORDER	S-d\MN2-i-n-p	Allowed when: S\MN\N > 0		Parity bit location.
		Range: Enumeration		
		Enumeration	Description	
		L	Leads word	
T	Trails word			
DATA TYPE	S-d\MBFM-i-n-p	Allowed when: S\MN\N > 0		Data type. If message data type is binary then only ASCII, signed, unsigned, and float are valid.
		Range: Enumeration		
		Enumeration	Description	
		ASCII	ASCII characters	
		FLOAT	Binary floating point data	
		SIGNED	Binary signed integer data	
		UNSIGNED	Binary unsigned integer data	
		HEX	ASCII characters 0-9, A-F	
		OCTAL	ASCII characters 0-7	
BINARY	ASCII characters 0 and 1			
<b>NOTE:</b> For binary messages, the data type describes the format of the raw input data as it appears in the stream. If FLOAT is specified in a binary message, the floating point format attribute describes the specific floating point data type. For ASCII messages, FLOAT, SIGNED, and UNSIGNED define how to interpret the ASCII data for conversion to an output data type for numeric processing.				
FLOATING POINT FORMAT	S-d\MFPP-i-n-p	Allowed when: S\MN\N > 0		If data type is “float”, specify which floating point format will be used. Only for binary message data type. See <a href="#">Appendix 9-D</a> for more information.
		Range: Enumeration		
		Enumeration	Description	

**Table 9-9. Message Data Attributes Group (S)**

Parameter	Code Name	Usage Attributes		Definition
		IEEE_32	IEEE 754 single precision	
		IEEE_64	IEEE 754 double precision	
		1750A_32	MIL-STD 1750A single precision	
		1750A_48	MIL-STD 1750A double precision	
		DEC_32	DEC single precision	
		DEC_64	DEC double precision	
		DEC_64G	DEC "G" double precision	
		IBM_32	IBM single precision	
		IBM_64	IBM double precision	
		TI_32	TI single precision	
		TI_40	TI extended precision	
DATA ORIENTATION	S-d\MDO-i-n-p	Allowed when: S\MN\N > 0		Data orientation. Binary data type only.
		Range: Enumeration		
		Enumeration	Description	
		L	Little endian	
		B	Big endian	
		Default: Big Endian		
<b>Measurement Location</b>				
NUMBER OF MEASUREMENT LOCATIONS	S-d\NML\N-i-n-p	Allowed when: S\MN\N > 0		If this measurement is contained in one field, enter "1". If this measurement is fragmented, enter the number of fragments.
		Range: 2 characters		
MESSAGE FIELD NUMBER	S-d\MFN-i-n-p-e	Allowed when: S\NML\N > 0		Enter the field number within a message that contains the measurement or the fragmented measurand.
		Range: 4 characters		
BIT MASK	S-d\MBM-i-n-p-e	Allowed when: S\NML\N > 0		Binary string of 1s and 0s to identify the bit locations



**Table 9-9. Message Data Attributes Group (S)**

Parameter	Code Name	Usage Attributes		Definition
		Range: Binary or FW		that are assigned to this measurement in the field identified above. If the entire field is used for this measurement, enter “FW”. Left-most bit corresponds to the msb.
TRANSFER ORDER	S-d\MTO-i-n-p-e	Allowed when: S\NML\N > 0		Specify transfer order bit as most significant or least significant.
		Range: Enumeration		
		Enumeration	Description	
		MSB	msb	
		LSB	lsb	
FRAGMENT POSITION	S-d\MFP-i-n-p-e	Allowed when: S\NML\N > 0		A number from 1 to N specifying the position of this fragment within the reconstructed binary field. 1 corresponds to the most significant fragment. Each fragment position from 1 to N must be specified only once.
		Range: 1-8		
<b>NOTE:</b> Repeat the above to describe each fragment of a fragmented field. The transfer order indicates whether to transpose the order of the bit sequence or not (lsb indicates to transpose the bit sequence).				
<b>Comments</b>				
COMMENTS	S-d\COM	Allowed when: S\DLN is specified		Provide the additional information requested or any other information desired.
		Range: 3200 characters		

9.5.10 Message Structure Attributes (Q)

The Message Data Structure group allows the definition of arbitrary messages that have no grammar themselves. A Q data link can contain one or more sources. Each source can contain one or more messages. Each message is made up of bits, elements, fields, measurements, and sub-messages. An element is a fixed number of bits. Elements are very much like words in PCM. They are the basic unit of the message. Fields are like measurements, but they are used for things like length and ID. Measurements are useful bits stored in the message. Sub-messages are like messages, but they may vary within a message. When referring to numbered items like elements of fields, the first item is numbered 0, which happens to be the same as an offset.

<b>Figure 9-10. Message Structure Attributes Group (Q)</b>		<b>Code Name</b>
	<b>DATA LINK NAME - 9-145</b>	(Q-d\DLN)
9-146	NUMBER OF SOURCES	(Q-d\NS\N)
	SOURCE NAME	(Q-d\SNA-i)
	MESSAGE ELEMENT SIZE	(Q-d\MES-i)
	MESSAGE HEADER DATA ORIENTATION	(Q-d\MHDO-i)
	MESSAGE OFFSET	(Q-d\MHO-i)
	MESSAGE HEADER SIZE	(Q-d\MHS-i)
	MESSAGE LENGTH TYPE	(Q-d\MLT-i)
	MESSAGE LENGTH FIELD OFFSET	(Q-d\MLFO-i)
	MESSAGE LENGTH FIELD SIZE	(Q-d\MLFS-i)
	MESSAGE LENGTH VALUE ELEMENT SIZE	(Q-d\MLVE-i)
	MESSAGE LENGTH VALUE BIAS	(Q-d\MLVB-i)
	MESSAGE LENGTH VALUE	(Q-d\MLV-i)
	<b>*Message Content Definition</b>	
9-147	NUMBER OF MESSAGES	(Q-d\NOM\N-i)
	MESSAGE NAME	(Q-d\MNM-i-n)
	MESSAGE STRUCTURE DESCRIPTION ID	(Q-d\MSDI-i-n)
	NUMBER OF MESSAGE HEADER ID FIELDS	(Q-d\MHIF\N-i-n)
	MESSAGE HEADER ID NAME	(Q-d\MHIN-i-n-m)
	MESSAGE HEADER ID OFFSET	(Q-d\MHIO-i-n-m)
	MESSAGE HEADER ID FIELD SIZE	(Q-d\MHIFS-i-n-m)
	MESSAGE HEADER ID VALUE	(Q-d\MHIV-i-n-m)
	MESSAGE HEADER ID MASK	(Q-d\MHIM-i-n-m)
		<b>*Measurement Description Set</b>
9-148	NUMBER OF MEASUREMENTS	(Q-d\NOMM\N-i-n)
	MEASUREMENT DESCRIPTION ID	(Q-d\MDI-i-n-m)
	MEASUREMENT NAME	(Q-d\MMNM-i-n-m)
	MEASUREMENT TRANSFER ORDER	(Q-d\MTO-i-n-m)
	<b>*Measurement Samples</b>	
	NUMBER OF MEASUREMENT SAMPLES	(Q-d\NMS\N-i-n-m)

<a href="#">9-149</a>	NUMBER OF SAMPLE FRAGMENTS	(Q-d\NSF\N-i-n-m-o)	
	FRAGMENT TRANSFER ORDER	(Q-d\MFTO-i-n-m-o)	
	MESSAGE ELEMENT NUMBER	(Q-d\MEN-i-n-m-o-p)	
	FRAGMENT LENGTH	(Q-d\MFL-i-n-m-o-p)	
	BIT MASK	(Q-d\MBM-i-n-m-o-p)	
	FRAGMENT POSITION	(Q-d\MFP-i-n-p-m-o-p)	
	<b>*Sub-Messages Content Definition</b>		
	SUB-MESSAGE HEADER DATA ORIENTATION	(Q-d\SMHDO-i-n)	
	SUB-MESSAGE HEADER OFFSET	(Q-d\SMHO-i-n)	
	SUB-MESSAGE HEADER SIZE	(Q-d\SMHS-i-n)	
	SUB-MESSAGE LENGTH TYPE	(Q-d\SMLT-i-n)	
	SUB-MESSAGE LENGTH FIELD OFFSET	(Q-d\SMLFO-i-n)	
	SUB-MESSAGE LENGTH FIELD SIZE	(Q-d\SMLFS-i-n)	
	SUB-MESSAGE LENGTH VALUE ELEMENT SIZE	(Q-d\SMLVE-i-n)	
	SUB-MESSAGE LENGTH VALUE BIAS	(Q-d\SMLVB-i-n)	
	SUB-MESSAGE LENGTH VALUE	(Q-d\SMLV-i-n)	
	NUMBER OF SUB-MESSAGES	(Q-d\SNOM\N-i-n)	
	SUB-MESSAGE NAME	(Q-d\SMNM-i-n-m)	
	SUB-MESSAGE STRUCTURE DESCRIPTION ID	(Q-d\SMSDI-i-n-m)	
	NUMBER OF SUB-MESSAGE HEADER ID FIELDS	(Q-d\SMHIF\N-i-n-m)	
	SUB-MESSAGE HEADER ID NAME	(Q-d\SMHIN-i-n-m-o)	
	SUB-MESSAGE HEADER ID OFFSET	(Q-d\SMHIO-i-n-m-o)	
	SUB-MESSAGE HEADER ID FIELD SIZE	(Q-d\SMHIFS-i-n-m-o)	
SUB-MESSAGE HEADER ID VALUE	(Q-d\SMHIV-i-n-m-o)		
SUB-MESSAGE HEADER ID MASK	(Q-d\SMHIM-i-n-m-o)		
<b>*Sub-Message Measurement Description Set</b>			
NUMBER OF MEASUREMENTS	(Q-d\SNOMM\N-i-n-m)		
MEASUREMENT DESCRIPTION ID	(Q-d\SMDI-i-n-m-o)		
MEASUREMENT NAME	(Q-d\SMMNM-i-n-m-o)		
MEASUREMENT TRANSFER ORDER	(Q-d\SMTO-i-n-m-o)		

[9-151](#)

<a href="#">9-152</a>	<b>*Sub-Message Measurement Samples</b>	
	NUMBER OF MEASUREMENT SAMPLES	(Q-d\SNMS\N-i-n-m-o)
	NUMBER OF SAMPLE FRAGMENTS	(Q-d\SNSF\N-i-n-m-o-p)
	FRAGMENT TRANSFER ORDER	(Q-d\SMFTO-i-n-m-o-p-e)
	SUB-MESSAGE ELEMENT NUMBER	(Q-d\SMEN-i-n-m-o-p-e)
	FRAGMENT LENGTH	(Q-d\SMFL-i-n-m-o-p-e)
	BIT MASK	(Q-d\SMBM-i-n-m-o-p-e)
	FRAGMENT POSITION	(Q-d\SMFP-i-n-m-o-p-e)
<a href="#">9-153</a>	<b>*Comments</b>	
	COMMENTS	(Q-d\COM)
<b>*Heading Only - No Data Entry</b>		

**Table 9-10. Message Structure Attributes Group (Q)**

Parameter	Code Name	Usage Attributes	Definition
DATA LINK NAME	Q-d\DLN	Allowed when: R\CDT is either MSGIN or 1394IN or ETHIN or FBCIN	Identify the data link name consistent with the Recorder-Reproducer group.
		Links from: R-x\CDLN, R-x\EV\DLN-n	
		Range: 32 characters	
NUMBER OF SOURCES	Q-d\NS\N	Allowed when: Q-d\DLN is specified	Specify the number of message data sources included within this data link.
		Required when: Allowed	
		Range: 1-32767	
SOURCE NAME	Q-d\SNA-i	Allowed when: Q-d\NS\N > 0	Specify the message data source name (subchannel name or same as data link name if no subchannel).
		Required when: Allowed	
		Range: 32 characters	
MESSAGE ELEMENT SIZE	Q-d\MES-i	Allowed when: Q-d\NS\N > 0	Element size in number of bits.
		Required when: Allowed	
		Range: 1-64	
MESSAGE HEADER DATA ORIENTATION	Q-d\MHDO-i	Allowed when: Q-d\MHS-i > 0	Specify the message header data orientation. If 'L' is specified, then the bytes are swapped to little endian on message element boundaries only and message element size must be 16 or 32 or 64.
		Required when: Allowed	
		Range: Enumeration 'L' = Little endian   'B' = Big endian	
MESSAGE OFFSET	Q-d\MHO-i	Allowed when: Q-d\NS\N > 0	Number of bytes from the start of frame to the start location of the first element of the message.
		Required when: Q-d\MHS-i > 0	
		Range: 0-999999	
MESSAGE HEADER SIZE	Q-d\MHS-i	Allowed when: Q-d\NS\N > 0	Message header size in number of elements. A value of zero indicates there is no message header present.
		Required when: Allowed	
		Range: 0-9999	
MESSAGE LENGTH TYPE	Q-d\MLT-i	Allowed when: Q-d\NS\N > 0	Message length type fixed or dynamic. Fixed = message length is fixed width defined in TMATS. Dynamic = message length is dynamic and defined within the message.
		Required when: Allowed	
		Range: Enumeration 'FIXED'   'DYNAMIC'	

**Table 9-10. Message Structure Attributes Group (Q)**

Parameter	Code Name	Usage Attributes	Definition
MESSAGE LENGTH FIELD OFFSET	Q-d\MLFO-i	Required when: Q-d\MLT-i = 'DYNAMIC'	Message length field offset in number of elements.
		Range: 0-9999	
MESSAGE LENGTH FIELD SIZE	Q-d\MLFS-i	Required when: Q-d\MLT-i = 'DYNAMIC'	Message length field size in number of elements. To get the actual message length in bits excluding the header, multiply the value in the message at the location defined by Q-d\MLFO-i and Q-d\MLFS-i by Q-d\MLVE-i.
		Range: 1-99	
MESSAGE LENGTH VALUE ELEMENT SIZE	Q-d\MLVE-i	Required when: Q-d\MLT-i = 'DYNAMIC'	Message length value element size in number of bits. See Q-d\MLFS-i definition.
		Range: 1-64	
MESSAGE LENGTH VALUE BIAS	Q-d\MLVB-i	Allowed when: Q-d\NS\N > 0	Integer number of bits that is added to the message size to make the value equal to the size of the entire message including the header and/or trailer. If Q-d\MLVB-i = 0, then it indicates that the message size includes the header and/or trailer. The total message size = (value in the message at the location defined by Q-d\MLFO-i and Q-d\MLFS-i) * Q-d\MLVE-i + (Q-d\MHS-i * Q-d\MES-i).
		Required when: Allowed	
		Range: Integer	
MESSAGE LENGTH VALUE	Q-d\MLV-i	Allowed when: Q-d\MLT-i = 'FIXED'	If message length type = fixed, specify the message length in number of elements. To get the actual message length in bits, multiply Q-d\MLVE-i * Q-d\MLV-i.
		Required when: Allowed	
		Range: 1-999999	
<b>Message Content Definition</b>			
NUMBER OF MESSAGES	Q-d\NOM\N-i	Allowed when: Q-d\NS\N > 0	The number of messages to be defined.
		Required when: Allowed	
		Range: 1-32767	
MESSAGE NAME	Q-d\MNM-i-n	Required when: Q-d\NOM\N-i > 0.	Unique message name.
		Range: 32 characters	

**Table 9-10. Message Structure Attributes Group (Q)**

Parameter	Code Name	Usage Attributes	Definition
MESSAGE STRUCTURE DESCRIPTION ID	Q-d\MSDI-i-n	Allowed when: Q-d\NOM\N-i > 0	A unique 32-bit value (ID) for each message. The value of zero (0) is reserved. This ID is used when a message is removed from a parent channel/stream and placed into a format 1 data structures packet virtual channel.
		Required when: Allowed	
		Range: Positive integer	
NUMBER OF MESSAGE HEADER ID FIELDS	Q-d\MHIF\N-i-n	Allowed when: Q-d\MHS-i > 0	Number of message header ID fields.
		Required when: Allowed	
		Range: 0-10	
MESSAGE HEADER ID NAME	Q-d\MHIN-i-n-m	Allowed when: Q-d\MHIF\N-i-n > 0	Unique message header ID name
		Required when: Allowed	
		Range: 32 characters	
MESSAGE HEADER ID OFFSET	Q-d\MHIO-i-n-m	Allowed when: Q-d\MHIF\N-i-n > 0	The message header ID field offset in number of elements from the beginning of the message.
		Required when: Allowed	
		Range: 0-9999	
MESSAGE HEADER ID FIELD SIZE	Q-d\MHIFS-i-n-m	Allowed when: Q-d\MHIF\N-i-n > 0	The message header ID field size in number of elements.
		Required when: Allowed	
		Range: 1-99	
MESSAGE HEADER ID VALUE	Q-d\MHIV-i-n-m	Allowed when: Q-d\MHIF\N-i-n > 0	Message header ID value. Value is hexadecimal if it starts with 0x.
		Required when: Allowed	
		Range: positive integer or 0	
MESSAGE HEADER ID MASK	Q-d\MHIM-i-n-m	Allowed when: Q-d\MHIF\N-i-n > 0	Binary string of 1s and 0s to identify the bit locations that are assigned to this message header ID mask. If the full element is used for this message header ID mask, enter "FW". Left-most bit corresponds to the msb.
		Required when: Allowed	
		Range: Binary or "FW"	
<b>Measurement Description Set</b>			
NUMBER OF MEASUREMENTS	Q-d\NOMM\N-i-n	Allowed when: Q-d\NOM\N-i > 0	Number of measurements linked to a message.
		Required when: Allowed	
		Range: 0-9999	

**Table 9-10. Message Structure Attributes Group (Q)**

Parameter	Code Name	Usage Attributes	Definition
MEASUREMENT DESCRIPTION ID	Q-d\MDI-i-n-m	Allowed when: Q-d\NOMM\N-i-n > 0	A system-wide unique 32-bit value (ID) for each measurement. The value of zero (0) is reserved. This ID is used when a message is removed from a parent channel/stream and placed into a format 1 message data structures packet virtual channel.
		Required when: Allowed	
		Range: 32-bit unsigned integer	
MEASUREMENT NAME	Q-d\MMNM-i-n-m	Allowed when: Q-d\NOMM\N-i-n > 0	Unique measurement name.
		Required when: Allowed	
		Links to: C-d\DCN	
		Range: 32 characters	
MEASUREMENT TRANSFER ORDER	Q-d\MTO-i-n-m	Allowed when: Q-d\NOMM\N-i-n > 0	Message measurement transfer order bit location.
		Required when: Allowed	
		Range: Enumeration	
		'M' = msb first   'L' = lsb first	
<b>Measurement Samples</b>			
NUMBER OF MEASUREMENT SAMPLES	Q-d\NMS\N-i-n-m	Allowed when: Q-d\NOMM\N-i-n > 0	Number of unique measurement values in the message.
		Required when: Allowed	
		Range: Positive Integer	
NUMBER OF SAMPLE FRAGMENTS	Q-d\NSF\N-i-n-m-o	Allowed when: Q-d\NMS\N-i-n-m > 0	The number of individual fragments that make up this sample of the measurement.
		Range: 1-8	
FRAGMENT TRANSFER ORDER	Q-d\MFTO-i-n-m-o	Allowed when: Q-d\NSF\N-i-n-m-o > 0	Message measurement transfer order. The transfer order indicates whether to transpose the order of the bit sequence or not (lsb indicates to transpose the bit sequence).
		Required when: Allowed	
		Range: Enumeration	
		'M' = msb first   'L' = lsb first	
MESSAGE ELEMENT NUMBER	Q-d\MEN-i-n-m-o-p	Allowed when: Q-d\NSF\N-i-n-m-o > 0	The data element number within a message that contains the measurement or the fragmented measurand. The first message element is numbered "1".
		Required when: Allowed	
		Range: 1-9999	



**Table 9-10. Message Structure Attributes Group (Q)**

Parameter	Code Name	Usage Attributes	Definition
FRAGMENT LENGTH	Q-d\MFL-i-n-m-o-p	Allowed when: Q-d\NSF\N-i-n-m-o > 0	Fragment length in elements.
		Required when: Allowed	
		Range: 1-99	
BIT MASK	Q-d\MBM-i-n-m-o-p	Allowed when: Q-d\NSF\N-i-n-m-o > 0	Binary string of 1s and 0s to identify the bit locations that are assigned to this message measurement in the element defined above. If the full element is used for this measurement, enter "FW". Left-most bit corresponds to the msb.
		Required when: Allowed	
		Range: Binary or "FW"	
FRAGMENT POSITION	Q-d\MFP-i-n-m-o-p	Allowed when: Q-d\NSF\N-i-n-m-o > 0	A number from 1 to N specifying the position of this fragment within the reconstructed binary data word. 1 corresponds to the most significant fragment. Each fragment position from 1 to N must be specified only once.
		Required when: Allowed	
		Range: 1-8	
NOTE: Repeat the above to describe the samples of a measurement and the fragments of the samples.			
<b>Sub-Message Content Definition</b>			
NUMBER OF SUB-MESSAGES	Q-d\SNOM\N-i-n	Allowed when: Q-d\NOM\N-i > 0	Number of sub-messages to be defined.
		Required when: Allowed	
		Range: 0-32767	
SUB-MESSAGE HEADER DATA ORIENTATION	Q-d\SMHDO-i-n	Allowed when: Q-d\SMHS-i-n > 0	Specify the sub-message header data orientation. If 'L' is specified, then the bytes are swapped to little endian on sub-message element boundaries only and message element size must be 16 or 32 or 64.
		Required when: Allowed	
		Range: Enumeration	
		'L' = Little endian      'B' = big endian	
SUB-MESSAGE HEADER OFFSET	Q-d\SMHO-i-n	Allowed when: Q-d\SMHS-i-n > 0	Number of bytes from the start of the message to the start of the first element of the sub-message.
		Required when: Allowed	
		Range = 0-999999	
SUB-MESSAGE HEADER SIZE	Q-d\SMHS-i-n	Allowed when: Q-d\SNOM\N-i-n > 0	Sub-message header size in number of elements. A value of zero indicates there is no sub-message header present.
		Required when: Allowed	
		Range: 1-9999	

**Table 9-10. Message Structure Attributes Group (Q)**

Parameter	Code Name	Usage Attributes	Definition
SUB-MESSAGE LENGTH TYPE	Q-d\SMLT-i-n	Allowed when: Q-d\SNOM\N-i-n > 0	Sub-message length type fixed or dynamic. Fixed = sub-message length is fixed width defined in TMATS. Dynamic = sub-message length is dynamic and defined within the sub-message.
		Required when: Allowed	
		Range: Enumeration	
		'FIXED'   'DYNAMIC'	
SUB-MESSAGE LENGTH FIELD OFFSET	Q-d\SMLFO-i-n	Allowed when: Q-d\SNOM\N-i-n > 0	Sub-message length field offset in number of elements.
		Required when: Q-d\SMLT-i-n is 'DYNAMIC'	
		Range: 0-9999	
SUB-MESSAGE LENGTH FIELD SIZE	Q-d\SMLFS-i-n	Allowed when: Q-d\SNOM\N-i-n > 0	Sub-message length field size in number of elements. To get the actual sub-message length in bits, multiply the value in the sub-message at the location defined by Q-d\SMLFO-i and Q-d\SMLFS-i by Q-d\SMLVE-i.
		Required when: Q-d\SMLT-i-n is 'DYNAMIC'	
		Range: 1-99	
SUB-MESSAGE LENGTH VALUE ELEMENT SIZE	Q-d\SMLVE-i-n	Allowed when: Q-d\SNOM\N-i-n > 0	Sub-message length value element size in number of bits. See Q-d\SMLFS-i definition.
		Required when: Allowed	
		Range: user select from 2, 4, 8, 16, or 32 bits	
SUB-MESSAGE LENGTH VALUE BIAS	Q-d\SMLVB-i-n	Allowed when: Q-d\SNOM\N-i-n > 0	Integer number of bits that is added to the sub-message size to make the value equal to the size of the entire sub-message, including the header and/or trailer. If Q-d\SMLVB-i-n = 0, then it indicates that the sub-message size includes the header and/or trailer. The total sub-message size = (value in the sub-message at the location defined by Q-d\SMLFO-i-n and Q-d\SMLFS-i-n) * Q-d\SMLVE-i-n + (Q-d\SMHS-i-n * Q-d\MES-i)
		Required when: Allowed	
		Range: integer	
SUB-MESSAGE LENGTH VALUE	Q-d\SMLV-i-n	Allowed when: Q-d\SMLT-i is 'FIXED'	If the sub-message length type = fixed, specify the sub-message length in number of elements. To get the actual sub-message length in bits, multiply Q-d\SMLVE-i * Q-d\SMLV-i.
		Required when: Allowed	
		Range: 1-999999	
SUB-MESSAGE NAME	Q-d\SMNM-i-n m	Allowed when: Q-d\SNOM\N-i-n > 0	Unique sub-message name
		Required when: Allowed	
		Range: 32 characters	

**Table 9-10. Message Structure Attributes Group (Q)**

Parameter	Code Name	Usage Attributes	Definition
SUB-MESSAGE STRUCTURE DESCRIPTION ID	Q-d\SMSDI-i-n-m	Allowed when: Q-d\SNOM\N-i-n > 0	A system-wide unique 32-bit value (ID) for each sub-message. The value of zero (0) is reserved. This ID is used when a sub-message is removed from a parent channel/stream and placed into a format 1 message data structures packet virtual channel.
		Range: 32-bit unsigned integer	
NUMBER OF SUB-MESSAGE HEADER ID FIELDS	Q-d\SMHIF\N-i-n-m	Allowed when: Q-d\SMHS-i-n > 0	Number of sub-message header ID fields
		Required when: Allowed	
		Range: 0-10	
SUB-MESSAGE HEADER ID NAME	Q-d\SMHIN-i-n-m-o	Allowed when: Q-d\SMHIF\N-i-n-m > 0	Unique sub-message header ID name
		Range: 32 characters	
SUB-MESSAGE HEADER ID OFFSET	Q-d\SMHIO-i-n-m-o	Allowed when: Q-d\SMHIF\N-i-n-m > 0	The sub-message header ID field offset in number of elements from the beginning of the sub-message.
		Required when: Allowed	
		Range: 1-9999	
SUB-MESSAGE ID HEADER FIELD SIZE	Q-d\SMHIFS-i-n-m-o	Allowed when: Q-d\SMHIF\N-i-n-m > 0	The sub-message header ID field size in number of elements.
		Required when: Allowed	
		Range: 1-99	
SUB-MESSAGE HEADER ID VALUE	Q-d\SMHIV-i-n-m-o	Allowed when: Q-d\SMHIF\N-i-n-m > 0	Sub-message header ID value. Value is hexadecimal if it starts with 0x.
		Required when: Allowed	
		Range: Positive integer or 0	
SUB-MESSAGE HEADER ID MASK	Q-d\SMHIM-i-n-m-o	Allowed when: Q-d\SMHIF\N-i-n-m > 0	Binary string of 1s and 0s to identify the bit locations that are assigned to this sub-message header ID mask. If the full element is used for this message header ID mask, enter "FW". Left-most bit corresponds to the msb.
		Required when: Allowed	
		Range: Binary or "FW"	
<b>Sub-Message Measurement Description Set</b>			
NUMBER OF MEASUREMENTS	Q-d\SNOMM\N-i-n-m	Allowed when: Q-d\SNOM\N-i-n > 0	Number of sub-message measurements (linked to a sub-message). Value is hexadecimal if it starts with 0x.
		Required when: Allowed	
		Range: 1-9999	

**Table 9-10. Message Structure Attributes Group (Q)**

Parameter	Code Name	Usage Attributes	Definition
MEASUREMENT DESCRIPTION ID	Q-d\SMDI-i-n-m-o	Allowed when: Q-d\SNOMM\N-i-n-m > 0	A system-wide unique 32-bit value (ID) for each sub-message measurement. The value of zero (0) is reserved. This ID is used when a sub-message is removed from a parent channel/stream and placed into a format 1 message data structures packet virtual channel.
		Required when: Allowed	
		Range: Positive integer	
MEASUREMENT NAME	Q-d\SMMNM-i-n-m-o	Allowed when: Q-d\SNOMM\N-i-n-m > 0	Unique measurement name.
		Required when: Allowed	
		Links to: C-d\DCN	
		Range: 32 characters	
MEASUREMENT TRANSFER ORDER	Q-d\SMTO-i-n-m-o	Allowed when: Q-d\SNOMM\N-i-n-m > 0	Sub-message measurement transfer order bit location.
		Required when: Allowed	
		Range: Enumeration	
		'M' = msb first      'L' = lsb first	
<b>Sub-Message Measurement Samples</b>			
NUMBER OF MEASUREMENT SAMPLES	Q-d\SNMS\N-i-n-m-o	Allowed when: Q-d\SNOMM\N-i-n-m > 0	Number of unique measurement values in the message.
		Required when: Allowed	
		Range: Positive Integer	
NUMBER OF SAMPLE FRAGMENTS	Q-d\SNSF\N-i-n-m-o-p	Allowed when: Q-d\SNMS\N-i-n-m-o > 0	The number of individual fragments that make up this sample of the measurement.
		Required when: Allowed	
		Range: 1-8	
FRAGMENT TRANSFER ORDER	Q-d\SMFTO-i-n-m-o-p	Allowed when: Q-d\SNMS\N-i-n-m-o > 0	Sub-message measurement transfer order bit location. The transfer order indicates whether to transpose the bit sequence or not (lsb indicates to transpose the bit sequence).
		Required when: Allowed	
		Range: Enumeration	
		'M' = msb first      'L' = lsb first	
SUB-MESSAGE ELEMENT NUMBER	Q-d\SMEN-i-n-m-o-p-e	Allowed when: Q-d\SNMS\N-i-n-m-o > 0	Enter the data element number within a sub-message that contains the measurement or the fragmented measurand.
		Required when: Allowed	
		Range: 1-9999	

**Table 9-10. Message Structure Attributes Group (Q)**

<b>Parameter</b>	<b>Code Name</b>	<b>Usage Attributes</b>	<b>Definition</b>
FRAGMENT LENGTH	Q-d\SMFL-i-n-m-o-p-e	Allowed when: Q-d\SNMS\N-i-n-m-o > 0	Fragment length in elements.
		Required when: Allowed	
		Range: 1-99	
BIT MASK	Q-d\SMBM-i-n-m-o-p-e	Allowed when: Q-d\SNMS\N-i-n-m-o > 0	Binary string of 1s and 0s to identify the bit locations that are assigned to this sub-message measurement in the word identified above. If the full word is used for this measurement, enter "FW". Left-most bit corresponds to the msb.
		Required when: Allowed	
		Range: Binary or "FW"	
FRAGMENT POSITION	Q-d\SMFP-i-n-m-o-p-e	Allowed when: Q-d\SNMS\N-i-n-m-o > 0	A number from 1 to N specifying the position of this fragment within the reconstructed binary data word. 1 corresponds to the most significant fragment. Each fragment position from 1 to N must be specified only once.
		Required when: Allowed	
		Range: 1-8	
NOTE: Repeat the above to describe the samples of a measurement and the fragments of the samples.			
<b>COMMENTS</b>			
COMMENTS	Q-d\COM	Allowed when: Q\DLN is specified. Range: 3200 characters	Provide the additional information requested or any other information desired.

9.5.11 Data Conversion Attributes (C)

The Data Conversion Attributes group includes a definition of the method by which the raw telemetry data is to be converted to meaningful information. The sensor calibration is contained in the group for each type of sensor that uses a standard calibration curve or for each sensor or parameter that has a unique calibration requirement. The calibration information can be entered in several different formats. Provision is made to permit a test organization to convert data set entries to coefficients of an appropriate curve fit and record the derived coefficients. [Figure 9-11](#) shows the structure of the data conversion attributes. [Table 9-11](#) contains the detailed information required.

 <p><b>NOTE</b></p>	<p>For reference purposes, the following telemetry unit definitions apply:</p> <ul style="list-style-type: none"> <li>• PCM - natural binary range as indicated by binary format entry</li> <li>• FM (Analog) - lower band edge (-100) to upper band edge (+100).</li> </ul>
--	--

<b>Figure 9-11. Data Conversion Attributes Group (C)</b>		<b>Code Name</b>
<b>MEASUREMENT NAME - <a href="#">9-157</a></b>		(C-d\DCN)
<a href="#">9-157</a>	<b>*Transducer Information</b>	
	TYPE	(C-d\TRD1)
	MODEL NUMBER	(C-d\TRD2)
	SERIAL NUMBER	(C-d\TRD3)
	SECURITY CLASSIFICATION	(C-d\TRD4)
	ORIGINATION DATE	(C-d\TRD5)
	REVISION NUMBER	(C-d\TRD6)
	ORIENTATION	(C-d\TRD7)
<a href="#">9-158</a>	<b>*Point of Contact</b>	
	NAME	(C-d\POC1)
	AGENCY	(C-d\POC2)
	ADDRESS	(C-d\POC3)
	TELEPHONE	(C-d\POC4)
<a href="#">9-158</a>	<b>*Measurand</b>	
	DESCRIPTION	(C-d\MN1)
	MEASUREMENT ALIAS	(C-d\MNA)
	EXCITATION VOLTAGE	(C-d\MN2)
	ENGINEERING UNITS	(C-d\MN3)
	LINK TYPE	(C-d\MN4)
<a href="#">9-158</a>	<b>*Telemetry Value Definition</b>	
	BINARY FORMAT	(C-d\BFM)
	<b>*Floating Point</b>	
	FLOATING POINT FORMAT	(C-d\FPF)
	<b>*Bit Weight</b>	
	NUMBER OF BITS	(C-d\BWT\N)
	BIT NUMBER	(C-d\BWTB-n)
	BIT WEIGHT VALUE	(C-d\BWTV-n)
<a href="#">9-160</a>	<b>*In-Flight Calibration</b>	
	NUMBER OF POINTS	(C-d\MC\N)

		STIMULUS	(C-d\MC1-n)
		TELEMETRY VALUE	(C-d\MC2-n)
		DATA VALUE	(C-d\MC3-n)
<a href="#">9-161</a>		<b>*Ambient Value</b>	
		NUMBER OF AMBIENT CONDITIONS	(C-d\MA\N)
		STIMULUS	(C-d\MA1-n)
		TELEMETRY VALUE	(C-d\MA2-n)
		DATA VALUE	(C-d\MA3-n)
<a href="#">9-161</a>		<b>*Measurement Filtering</b>	
		FILTERING ENABLED	(C-d\FEN)
		FILTERING DELAY	(C-d\FDL)
		NUMBER OF FILTERS	(C-d\F\N)
		FILTER TYPE	(C-d\FTY-n)
		NUMBER OF POLES OR SAMPLES	(C-d\FNPS-n)
<a href="#">9-162</a>		<b>*Other Information</b>	
		HIGH MEASUREMENT VALUE	(C-d\MOT1)
		LOW MEASUREMENT VALUE	(C-d\MOT2)
		HIGH ALERT LIMIT VALUE	(C-d\MOT3)
		LOW ALERT LIMIT VALUE	(C-d\MOT4)
		HIGH WARNING LIMIT VALUE	(C-d\MOT5)
		LOW WARNING LIMIT VALUE	(C-d\MOT6)
		INITIAL VALUE	(C-d\MOT7)
		SAMPLE RATE	(C-d\SR)
<a href="#">9-163</a>		<b>*Data Conversion</b>	
		DATE AND TIME RELEASED	(C-d\CRT)
		CONVERSION TYPE	(C-d\DCT)
<a href="#">9-163</a>		<b>*Engineering Units Conversion</b>	
<a href="#">9-163</a>		<b>*Pair Sets</b>	
		NUMBER OF SETS	(C-d\PS\N)
		APPLICATION	(C-d\PS1)
		ORDER OF FIT	(C-d\PS2)
		TELEMETRY VALUE	(C-d\PS3-n)
		ENGINEERING UNITS VALUE	(C-d\PS4-n)
<a href="#">9-164</a>	OR	<b>*Coefficients</b>	
		ORDER OF CURVE FIT	(C-d\CO\N)
<a href="#">9-164</a>		DERIVED FROM PAIR SET	(C-d\CO1)
		COEFFICIENT (0)	(C-d\CO)
		N-TH COEFFICIENT	(C-d\CO-n)
	OR	<b>*Coefficients (Negative Powers of X)</b>	
		ORDER	(C-d\NPC\N)
		DERIVED FROM PAIR SET	(C-d\NPC1)
		COEFFICIENT (0)	(C-d\NPC)
		N-TH COEFFICIENT	(C-d\NPC-n)
<a href="#">9-165</a>	OR	<b>*Other</b>	

		DEFINITION OF OTHER DATA	(C-d\OTH)
		CONVERSION	
<a href="#">9-166</a>	OR	<b>*Derived Parameter</b>	
		ALGORITHM TYPE	(C-d\DPAT)
		ALGORITHM	(C-d\DPA)
		TRIGGER MEASURAND	(C-d\DPTM)
		NUMBER OF OCCURRENCES	(C-d\DPNO)
		NUMBER OF INPUT MEASURANDS	(C-d\DP\N)
		MEASURAND #N	(C-d\DP-n)
		NUMBER OF INPUT CONSTANTS	(C-d\DPC\N)
		CONSTANT #N	(C-d\DPC-n)
<a href="#">9-167</a>	OR	<b>*Discrete</b>	
		NUMBER OF EVENTS	(C-d\DIC\N)
		NUMBER OF INDICATORS	(C-d\DIC\N)
		CONVERSION DATA	(C-d\DICC-n)
		PARAMETER EVENT DEFINITION	(C-d\DICP-n)
<a href="#">9-167</a>	OR	<b>* PCM Time</b>	
		PCM TIME WORD FORMAT	(C-d\PTM)
<a href="#">9-167</a>	OR	<b>* 1553 Time</b>	
		1553 TIME WORD FORMAT	(C-d\BTM)
<a href="#">9-168</a>	OR	<b>*Digital Voice</b>	
		ENCODING METHOD	(C-d\VOI\E)
		DESCRIPTION	(C-d\VOI\D)
<a href="#">9-168</a>	OR	<b>*Digital Video</b>	
		ENCODING METHOD	(C-d\VID\E)
		DESCRIPTION	(C-d\VID\D)
		<b>*Comments</b>	
<a href="#">9-168</a>		COMMENTS	(C-d\COM)
*Heading Only - No Data Entry			



**Table 9-11. Data Conversion Attributes Group (C)**

Parameter	Code Name	Usage Attributes	Definition	
MEASUREMENT NAME	C-d\DCN	Allowed when: Always	Give the measurement name.	
		Links from: R-x\AMN-n-m , R-x\AMN-n-m M-x\SI\MN-n , M-x\BB\MN , D-x\MN-y-n , B-x\UMN1-i , B-x\UMN2-i , B-x\UMN3-i , B-x\MN-i-n-p , S-d\MN-i-n-p, R-x\DMN-n-m		
		Range: 32 characters		
<b>Transducer Information</b>				
TYPE	C-d\TRD1	Allowed when: C-d\DCN is specified	Type of sensor, if appropriate.	
		Range: 32 characters		
MODEL NUMBER	C-d\TRD2	Allowed when: C-d\DCN is specified	If appropriate.	
		Range: 32 characters		
SERIAL NUMBER	C-d\TRD3	Allowed when: C-d\DCN is specified	If applicable.	
		Range: 32 characters		
SECURITY CLASSIFICATION	C-d\TRD4	Allowed when: C-d\DCN is specified	Enter the security classification of this measurand. Append the following: If received telemetry signal (Counts) is classified, add “R”. If expressed in engineering units, the measurand value is classified, add “E”. If both are classified, add “B”.	
		Range: Enumeration		
		Enumeration		Description
		U		Unclassified
		C		Confidential
		S		Secret
		T		Top secret
O	Other			
ORIGINATION DATE	C-d\TRD5	Allowed when: C-d\DCN is specified	Date of origination of this data file. “DD” (Day). “MM” (Month). “YYYY” (Year).	
		Range: MM-DD-YYYY		
REVISION NUMBER	C-d\TRD6	Allowed when: C-d\DCN is specified	Specify the revision number of the data provided.	
		Range: 4 characters		
ORIENTATION	C-d\TRD7	Allowed when: C-d\DCN is specified	Describe the physical orientation of the sensor.	
		Range: 32 characters		

**Table 9-11. Data Conversion Attributes Group (C)**

Parameter	Code Name	Usage Attributes	Definition								
<b>Point of Contact</b>											
NAME	C-d\POC1	Allowed when: C-d\DCN is specified Range: 24 characters	Point of contact with the organization that provided the calibration data.								
AGENCY	C-d\POC2	Allowed when: C-d\DCN is specified Range: 48 characters	Point of contact with the organization that provided the calibration data.								
ADDRESS	C-d\POC3	Allowed when: C-d\DCN is specified Range: 48 characters	Point of contact with the organization that provided the calibration data.								
TELEPHONE	C-d\POC4	Allowed when: C-d\DCN is specified Range: 20 characters	Point of contact with the organization that provided the calibration data.								
<b>Measurand</b>											
DESCRIPTION	C-d\MN1	Allowed when: C-d\DCN is specified Range: 64 characters	Describe the parameter being measured.								
MEASUREMENT ALIAS	C-d\MNA	Allowed when: C-d\DCN is specified Range: 32 characters	Alternate measurand name.								
EXCITATION VOLTAGE	C-d\MN2	Allowed when: C-d\DCN is specified Range: 10 characters	Sensor reference voltage, in volts.								
ENGINEERING UNITS	C-d\MN3	Allowed when: C-d\DCN is specified Range: 16 characters	Define the engineering units applicable to the output data.								
LINK TYPE	C-d\MN4	Allowed when: C-d\DCN is specified Range: Enumeration <table border="1" style="width: 100%; border-collapse: collapse;"> <thead> <tr> <th style="width: 50%;">Enumeration</th> <th style="width: 50%;">Description</th> </tr> </thead> <tbody> <tr> <td>ANA</td> <td>FM (analog)</td> </tr> <tr> <td>PCM</td> <td></td> </tr> <tr> <td>OTH</td> <td>Other</td> </tr> </tbody> </table> Default: PCM	Enumeration	Description	ANA	FM (analog)	PCM		OTH	Other	Define the source data link type.
Enumeration	Description										
ANA	FM (analog)										
PCM											
OTH	Other										
<b>Telemetry Value Definition</b>											
BINARY FORMAT	C-d\BFM	Allowed when: C-d\DCN is specified Required when: Allowed Range: Enumeration	Format of the binary information.								

**Table 9-11. Data Conversion Attributes Group (C)**

<b>Table 9-11. Data Conversion Attributes Group (C)</b>				
<b>Parameter</b>	<b>Code Name</b>	<b>Usage Attributes</b>		<b>Definition</b>
		Enumeration	Description	
		INT	Integer	
		UNS	Unsigned Binary	
		SIG	Sign And Magnitude Binary [+ =0]	
		SIM	Sign And Magnitude Binary [+ =1]	
		ONE	One's Complement	
		TWO	Two's Complement	
		OFF	Offset Binary	
		FPT	Floating Point	
		BCD	Binary Coded Decimal	
		BWT	Bit Weight	
		OTH	Other, define in comments	
<b>Floating Point</b>				
FLOATING POINT FORMAT	C-d\FPF	Allowed when: C\BFM is "FPT"		If binary format is "FPT", specify which floating point format will be used. Other formats are not excluded. See <a href="#">Appendix 9-D</a> for more information.
		Required when: Allowed		
		Range: Enumeration		
		Enumeration	Description	
		IEEE_32	IEEE 754 single precision	
		IEEE_64	IEEE 754 double precision	
		1750A_32	MIL-STD-1750A single precision	
		1750A_48	MIL-STD-1750A double precision	
		DEC_32	DEC single precision	
		DEC_64	DEC double precision	
		DEC_64G	DEC "G" double precision	

**Table 9-11. Data Conversion Attributes Group (C)**

Parameter	Code Name	Usage Attributes	Definition
		IBM_32	IBM single precision
		IBM_64	IBM double precision
		TI_32	TI single precision
		TI_40	TI extended precision
<b>Bit Weight</b>			
NUMBER OF BITS	C-d\BWT\N	Allowed when: C\BFM is “BWT”	Specify the number of bits that will have a weighted value assigned.
		Required when: Allowed	
		Range 1-64	
BIT NUMBER	C-d\BWTB-n	Allowed when: C\BFM is “BWT”	Bit number, as defined in <a href="#">Chapter 4</a> , Subparagraph 4.3.1.c (msb is bit 1).
		Required when: Allowed	
		Range 1-64	
BIT WEIGHT VALUE	C-d\BWTV-n	Allowed when: C\BFM is “BWT”	Numerical value indicated by each bit. To specify the sign bit, enter “S”.
		Required when: Allowed	
		Range: Floating Point or “S”	
<b>In-Flight Calibration</b>			
NUMBER OF POINTS	C-d\MC\N	Allowed when: C-d\DCN is specified and defining “Inflight Calibration”	Is in-flight calibration required? “N” for no or the number of calibration points.
		Range: 0-999 or “N”	
		Default: N	
STIMULUS	C-d\MC1-n	Allowed when: C-d\MC\N is not N	Provide the stimulus for this calibration point.
		Range: 32 characters	
TELEMETRY VALUE	C-d\MC2-n	Allowed when: C-d\MC\N is not N	Telemetry units value.
		Required when: Allowed	
		Range: Integer	
DATA VALUE	C-d\MC3-n	Allowed when: C-d\MC\N is not N	Engineering units value.
		Required when: Allowed	
		Range: Floating Point	
<b>NOTE:</b> The above set of three entries must be repeated for each in-flight calibration point.			

**Table 9-11. Data Conversion Attributes Group (C)**

Parameter	Code Name	Usage Attributes	Definition	
<b>Ambient Value</b>				
NUMBER OF AMBIENT CONDITIONS	C-d\MA\N	Allowed when: C-d\DCN is specified and defining “Ambient Values”	Number of static or simulated conditions.	
		Range: 0-999		
		Default: 0		
STIMULUS	C-d\MA1-n	Allowed when: C-d\MA\N is not 0	Description of the static environment in which a non-test stimulus or simulator is the data source.	
		Range: 32 characters		
TELEMETRY VALUE	C-d\MA2-n	Allowed when: C-d\MA\N is not 0	Telemetry units value for the static stimulus.	
		Required when: Allowed		
		Range: Integer		
DATA VALUE	C-d\MA3-n	Allowed when: C-d\MA\N is not 0	Engineering units value for the static or simulated condition.	
		Required when: Allowed		
		Range: Floating Point		
<b>Measurement Filtering</b>				
FILTERING ENABLED	C-d\FEN	Allowed when: C-d\DCN is specified	Indicate if the data has been filtered by the data acquisition system	
		Range: Enumeration		
		Enumeration		Description
		T		True
		F		False
Default: F				
FILTERING DELAY	C-d\FDL	Allowed when: C-d\FEN is T	Specify the signal conditioner filter delay in milliseconds	
		Range: Floating Point		
NUMBER OF FILTERS	C-d\F\N	Allowed when: C-d\FEN is T	Specify the number of filters for this measurement in the acquisition system	
		Range: 0 to 10		
		Default: 0		
FILTER TYPE	C-d\FTY-n	Allowed when: C-d\FEN is T	Indicate the type of filter that was applied to the data by the data acquisition system	
		Range: Enumeration		
		Enumeration		Description
		BUTTERWORTH		n-Pole Butterworth

**Table 9-11. Data Conversion Attributes Group (C)**

Parameter	Code Name	Usage Attributes		Definition
		BESSEL	n-Pole Bessel	
		CHEBYSHEV	n-Pole Chebyshev	
		FIR	FIR n Samples	
		OTHER	Specify in comments	
NUMBER OF POLES OR SAMPLES	C-d\FNPS-n	Allowed when: C-d\FEN is T		Indicate the number of poles or samples used in the filter
<b>Other Information</b>				
HIGH MEASUREMENT VALUE	C-d\MOT1	Allowed when: C-d\DCN is specified Range: Floating Point		Highest engineering unit value defined in the calibration data.
LOW MEASUREMENT VALUE	C-d\MOT2	Allowed when: C-d\DCN is specified Range: Floating Point		Lowest engineering unit value defined in the calibration data.
HIGH ALERT LIMIT VALUE	C-d\MOT3	Allowed when: C-d\DCN is specified Range: Floating Point		Highest engineering unit value expected or safe operating value of the parameter (“red”).
LOW ALERT LIMIT VALUE	C-d\MOT4	Allowed when: C-d\DCN is specified Range: Floating Point		Lowest engineering unit value expected or safe operating value of the parameter (“red”).
HIGH WARNING LIMIT VALUE	C-d\MOT5	Allowed when: C-d\DCN is specified Range: Floating Point		Highest engineering unit value expected or safe operating value of the parameter (“yellow”).
LOW WARNING LIMIT VALUE	C-d\MOT6	Allowed when: C-d\DCN is specified Range: Floating Point		Lowest engineering unit value expected or safe operating value of the parameter (“yellow”).
INITIAL VALUE	C-d\MOT7	Allowed when: C-d\DCN is specified Range: Floating Point		For Chapter 10 recorders, this is the initial engineering unit value used for mode 7 measurement change event conditions.
SAMPLE RATE	C-d\SR	Allowed when: C-d\DCN is specified Range: 6 characters		Enter the sample rate in terms of samples per second.

**Table 9-11. Data Conversion Attributes Group (C)**

Parameter	Code Name	Usage Attributes	Definition	
<b>Data Conversion</b>				
DATE AND TIME RELEASED	C-d\CRT	Allowed when: C-d\DCN is specified Range: MM-DD-YYYY-HH-MI-SS	Date and time calibration was released using the format defined in Subsection 9.5.1.	
CONVERSION TYPE	C-d\DCT	Allowed when: C-d\DCN is specified	Define the characteristics of the data conversion.	
		Required when: Allowed		
		Range: Enumeration		
		Enumeration		Description
		NON		None
		Engineering Units:		
		PRS		Pair Sets
		COE		Coefficients
		NPC		Coefficients [Negative Powers Of X]
		DER		Derived
		DIS		Discrete
		PTM		PCM Time
		BTM		1553 Time
		VOI		Digital Voice
		VID		Digital Video
OTH	Other			
SP	Special Processing, enter in comments			
<b>Engineering Units Conversion</b>				
<b>Pair Sets</b>				
NUMBER OF SETS	C-d\PS\N	Allowed when: C\DCT is "PRS" or C-d\CO1 is "Y"	Specify the number of pair sets provided, n.	
		Required when: Allowed		
		Range: 2-32		

**Table 9-11. Data Conversion Attributes Group (C)**

Parameter	Code Name	Usage Attributes		Definition
APPLICATION	C-d\PS1	Allowed when: C\DCT is “PRS”		Are the pair sets to be used to define a polynomial curve fit? If the answer is no, then the pair sets are to be used as a “table lookup” with linear interpolation between the defined points.
		Range: Enumeration		
		Enumeration	Description	
		Y	Yes	
		N	No	
Default: N				
ORDER OF FIT	C-d\PS2	Allowed when: C\PS1 is “Y”		Specify the order of the curve fit to be performed, m. At least 2 pair sets must be provided, and a maximum of 32 pair sets may be included. Twelve or more pair sets are recommended for a fifth order fit. Use “BF” for Best Fit.
		Required when: Allowed		
		Range: 1-100 or “BF”		
TELEMETRY VALUE	C-d\PS3-n	Allowed when: C\DCT is “PRS” or C-d\CO1 is “Y”		Telemetry units value.
		Required when: Allowed		
		Range: Floating Point		
ENGINEERING UNITS VALUE	C-d\PS4-n	Allowed when: C\DCT is “PRS” or C-d\CO1 is “Y”		Engineering units value.
		Required when: Allowed		
		Range: Floating Point		
<b>NOTE:</b> Repeat the above for the n pair sets.				
<b>Coefficients</b>				
ORDER OF CURVE FIT	C-d\CO\N	Allowed when: C\DCT is “COE”		Specify the order of the polynomial curve fit, n.
		Required when: Allowed		
		Range: 1-100		
DERIVED FROM PAIR SET	C-d\CO1	Allowed when: C\DCT is “COE”		Were the coefficients derived from the pair set calibration data provided (“Y” or “N”)? If yes, provide a point of contact in the comments.
		Range: Enumeration		
		Enumeration	Description	
		Y	Yes	
		N	No	
Default: N				



**Table 9-11. Data Conversion Attributes Group (C)**

<b>Table 9-11. Data Conversion Attributes Group (C)</b>				
<b>Parameter</b>	<b>Code Name</b>	<b>Usage Attributes</b>		<b>Definition</b>
COEFFICIENT (0)	C-d\CO	Allowed when: C\DCT is “COE”		Value of the zero-order term (offset).
		Required when: Allowed		
		Range: Floating Point		
N-TH COEFFICIENT	C-d\CO-n	Allowed when: C\DCT is “COE”		Value of the coefficient of the n <sup>th</sup> power of x (first order coefficient is the equivalent of bit weight).
		Required when: Allowed		
		Range: Floating Point		
<b>NOTE:</b> Repeat until all n+1 coefficients are defined.				
<b>Coefficients (Negative Powers of X)</b>				
ORDER	C-d\NPC\N	Allowed when: C\DCT is “NPC”		Specify the order of negative power coefficients, n.
		Required when: Allowed		
		Range: 1-100		
DERIVED FROM PAIR SET	C-d\NPC1	Allowed when: C\DCT is “NPC”		Were the coefficients derived from the pair set calibration data provided (“Y” or “N”)? If yes, provide a point of contact in the comments.
		Range: Enumeration		
		Enumeration	Description	
		Y	Yes	
		N	No	
Default: N				
COEFFICIENT (0)	C-d\NPC	Allowed when: C\DCT is “NPC”		Value of the zero-order term (offset).
		Required when: Allowed		
		Range: Floating Point		
N-TH COEFFICIENT	C-d\NPC-n	Allowed when: C\DCT is “NPC”		Value of the coefficient of the negative n <sup>th</sup> power of x.
		Required when: Allowed		
		Range: Floating Point		
<b>NOTE:</b> Repeat until all n+1 coefficients are defined. This section describes the conversion equation $y=c_0 + c_1*(1/x) + c_2*(1/x^2) + \dots + c_n*(1/x^n)$ , where $c_0, c_1, c_2, \dots, c_n$ are the coefficients, $x$ is the telemetry value, and $y$ is the resulting EU value.				
<b>Other</b>				
DEFINITION OF OTHER DATA CONVERSION	C-d\OTH	Allowed when: C\DCT is “OTH” or “SP”		Define other data conversion technique or special processing requirement.
		Required when: Allowed		
		Range: 1000 characters		

**Table 9-11. Data Conversion Attributes Group (C)**

Parameter	Code Name	Usage Attributes	Definition	
<b>Derived Parameter</b>				
ALGORITHM TYPE	C-d\DPAT	Allowed when: C\DCT is “DER”	Specify whether the algorithm will be given (in C-d\DPA) as: “N” (Name of algorithm). “A” (Algorithm). See <a href="#">Appendix 9-E</a> for additional details.	
		Required when: Allowed		
		Range: Enumeration		
		Enumeration		Description
		N		Name of algorithm
A	Algorithm			
ALGORITHM	C-d\DPA	Allowed when: C\DCT is “DER”	Define the algorithm to be used in deriving the parameter. See <a href="#">Appendix 9-E</a> for additional details.	
		Required when: Allowed		
		Range: 1024 characters		
TRIGGER MEASURAND	C-d\DPTM	Allowed when: C\DCT is “DER”	Specify the name of the input measurand that triggers the calculation of the derived parameter.	
		Required when: Allowed		
		Range: 32 characters		
		Links to: C-d\DCN		
NUMBER OF OCCURRENCES	C-d\DPNO	Allowed when: C\DCT is “DER”	Specify how many times the trigger measurand must occur before the calculation is done. Default is 1.	
		Range: 2 characters		
NUMBER OF INPUT MEASURANDS	C-d\DP\N	Allowed when: C\DPAT is “N”	Specify the number of input measurands used to derive this parameter.	
		Required when: Allowed		
		Range: 1-100		
MEASURAND #N	C-d\DP-n	Allowed when: C\DPAT is “N”	Specify the name of the n <sup>th</sup> input measurand.	
		Required when: Allowed		
		Range: 32 characters		
		Links to: C-d\DCN		
<b>NOTE:</b> Continue until all n measurands are defined.				
NUMBER OF INPUT CONSTANTS	C-d\DPC\N	Allowed when: C\DPAT is “N”	Specify the number of input constants used to derive this parameter.	
		Required when: Allowed		
		Range: 1-100		
CONSTANT #N	C-d\DPC-n	Allowed when: C\DPAT is “N”	Specify the value for the n <sup>th</sup> constant.	
		Required when: Allowed		

**Table 9-11. Data Conversion Attributes Group (C)**

Parameter	Code Name	Usage Attributes	Definition	
		Range: Floating Point		
<b>NOTE:</b> Continue until all n constants are defined.				
<b>Discrete</b>				
NUMBER OF EVENTS	C-d\DIC\N	Allowed when: C\DCT is “DIS”	How many events are associated with this discrete field, n?	
		Required when: Allowed		
		Range: 1-100		
NUMBER OF INDICATORS	C-d\DI\N	Allowed when: C\DCT is “DIS”	Number of indicators: For a PCM system, provide the number of bits used for this discrete set. For an analog channel, provide the number of levels used to define this discrete set.	
		Required when: Allowed		
		Range: 1-100		
CONVERSION DATA	C-d\DI\CC-n	Allowed when: C\DCT is “DIS”	Telemetry value, counts for PCM, percent of full scale for analog.	
		Required when: Allowed		
		Range: Floating Point		
PARAMETER EVENT DEFINITION	C-d\DI\CP-n	Allowed when: C\DCT is “DIS”	Define the event for the bit or bit field in a word that corresponds to a discrete event or the percent full scale value such as switch on or off.	
		Required when: Allowed		
		Range: 240 characters		
<b>NOTE:</b> Continue to define the events for each bit pattern or value of the discrete measurand.				
<b>PCM Time</b>				
PCM TIME WORD FORMAT	C-d\PTM	Allowed when: C\DCT is “PTM”	Specify the PCM time word format used, as defined in <a href="#">Chapter 4</a> (Section 4.7).	
		Required when: Allowed		
		Range: Enumeration		
		Enumeration		Description
		H		High-order time
		L		Low-order time
M	Microsecond time			
<b>1553 Time</b>				
1553 TIME WORD FORMAT	C-d\BTM	Allowed when: C\DCT is “BTM”	Specify the 1553 time word format used, as defined in <a href="#">Chapter 4</a> (Section 4.7) and <a href="#">Chapter 8</a> (Section 8.3).	
		Required when: Allowed		
		Range: Enumeration		

**Table 9-11. Data Conversion Attributes Group (C)**

<b>Table 9-11. Data Conversion Attributes Group (C)</b>				
<b>Parameter</b>	<b>Code Name</b>	<b>Usage Attributes</b>		<b>Definition</b>
		Enumeration	Description	
		H	High-order time	
		L	Low-order time	
		M	Microsecond time	
		R	Response time	
<b>Digital Voice</b>				
ENCODING METHOD	C-d\VOI\E	Allowed when: C\DCT is “VOI”		Specify the voice encoding method used.
		Required when: Allowed		
		Range: Enumeration		
		Enumeration	Description	
		CVSD	Continuously Variable Slope Delta modulation	
		OTHR	Other	
DESCRIPTION	C-d\VOI\D	Allowed when: C\DCT is “VOI”		Specify the decoding algorithm to be used.
		Required when: Allowed		
		Required condition: When C\VOI\E is “OTHR”		
		Range: 640 characters		
<b>Digital Video</b>				
ENCODING METHOD	C-d\VID\E	Allowed when: C\DCT is “VID”		Specify the video encoding method used.
		Required when: Allowed		
		Range: 64 characters		
DESCRIPTION	C-d\VID\D	Allowed when: C\DCT is “VID”		Specify the decoding algorithm to be used.
		Required when: Allowed		
		Range: 640 characters		
<b>Comments</b>				
COMMENTS	C-d\COM	Allowed when: C-d\DCN is specified		Provide the additional information requested or any other information desired.
		Range: 3200 characters		

### 9.5.12 Airborne Hardware Attributes (H)

The Airborne Hardware Attributes group defines the specific configuration of airborne instrumentation hardware in use on the item under test. This group allows the same TMATS file to describe the airborne hardware as well as the telemetry attributes.

Specific information on the structure and definition of airborne hardware attributes is not included in this standard. There are far too many hardware systems to try to define them all in one group. The main purpose of identifying this group is to reserve the “H” designation for those instrumentation organizations that choose to use the TMATS standard in this way.

The only H group attributes defined in this standard are the following:

- a. Test Item (code name H\TA) - specifies the item under test and ties the H group to the G group.
- b. Airborne System Type (code name H\ST-n) - identifies the airborne systems being described in the current file and determines how the rest of the attributes in the H group will be interpreted.

 <b>NOTE</b>	For anyone wishing to define an H group, it is strongly recommended that the conventions laid out in this standard be followed. The resultant document should maintain the look and feel of this standard for consistency.
---	--

### 9.5.13 Vendor-Specific Attributes (V)

The Vendor-Specific Attributes group provides information that is specific to a vendor. This group allows the TMATS file to include information about a particular vendor’s equipment in use during a test. Detailed information about specific vendors’ equipment is not included in this standard.

The only V-group attributes defined in this standard are the following.

- a. Data Source ID (code name V-x\ID) - specifies the Data Source ID consistent with the General Information group and ties the V group to the G group.
- b. Vendor Name (code name V-x\VN) - a three-character acronym that identifies the specific vendor and determines how the rest of the attributes in the V group are interpreted.

All other code names for vendor-specific attributes will have the form:

V-x\acr\attribute-string

where: *acr* is the three-character acronym identifying a specific vendor.

*attribute-string* is any attribute that applies to this vendor.

 <b>NOTE</b>	For anyone wishing to define a V group, it is strongly recommended that the conventions laid out in this standard be followed. The resultant document should maintain the look and feel of this standard for consistency.
---	---

#### 9.5.14 TMATS eXtension Attributes (X)

The TMATS may be extended using X attributes. The format is described below:

$X-x \backslash ORGANIZATION \backslash ORIGCODE \backslash EXTENSION\_CODE-i-j-m-n:Value;$

Everything to the right of *ORGANIZATION* that matches an existing TMATS code is used to associate the extension with an existing object defined by the TMATS file.

The *ORIGCODE* contains the original group identifier (i.e., G,D,P, etc.) followed by a “\” and the original code that is to be extended (may include more “\” characters, but no “-”). The *EXTENSION\_CODE* identifies the specific extension and shall be unique (i.e., not overlapping any existing TMATS code name). The value of “-x” must match the first level index (P-x, etc.) value and the “-i-j” (the number of indexes defined by the original code) must match the same number of indexes in this extension code. The remaining “-m-n” values are unique to the extension.

For example, to extend a D section measurement:

$D-1 \backslash MN-1-2:MEAS1;$

To add a new extension code name for Sensor Gain, the following would define the extension:

$X-1 \backslash MYORG \backslash D \backslash MN \backslash SGAIN-1-2:10.75;$

In this example, the -1 in the “X-1” and “-1-2” corresponds to the “-1” and “-1-2” in the original “D-1\MN-1-2” code word.

If the extension has more indexes than the original code, then the indexes of the original code link to the same number of left most indexes of the extension code.

The value of *ORGANIZATION* should be a unique name that identifies the organization that defined the extension.

The advantage of this extension is that software that is processing the TMATS will know that these codes refer to a particular item in the file (like a measurement or recorder). For software that recognizes the codes, it can process them. Otherwise they can be ignored.

If the file is being edited by a TMATS editor, it would notice the association and preserve it even if the editor doesn’t know what the code means. Thus if the measurements were re-numbered and the index was 1-5 instead of 1-2, the extension code could be updated to preserve the link.

The values of “x” in “X-x” are not necessarily contiguous. The “x” values must match the index of the original code word therefore no new values may be added.

## 9.6 **Data Display Standard: Data Display Markup Language**

The standard format, DDML, has been developed to describe commonly used data displays. This DDML standard exists only as a collection of XSD files; it does not exist in the TMATS code name format described in Section 9.5. The DDML schema can be found [here](#). Additionally, a graphical depiction of the schema in hypertext markup language (HTML) format

is available [here](#). The HTML files are very large and will take time to download. The following paragraphs explain the purpose, objectives, and structure of DDML, and define the global elements in the schema.

9.6.1 Data Display Markup Language Purpose and Objectives

The purpose of DDML is to serve as the neutral interchange language between data display languages supported by different vendors. Built on XML, DDML has been designed with the following objectives in mind:

- a. To include a standard terminology for describing data display components;
- b. To be robust and highly expressive in order to accommodate any data display language;
- c. To be highly unified and not a loose grouping of vendor formats.

9.6.2 Data Display Markup Language Layered Structure

The DDML is built off of a layered structure as shown on the left of [Figure 9-12](#) below. This structure is parallel to a typical software layered architecture composed of graphics resources, visualization and user interfaces, information management, and persistence modules as shown on the right side of [Figure 9-12](#).

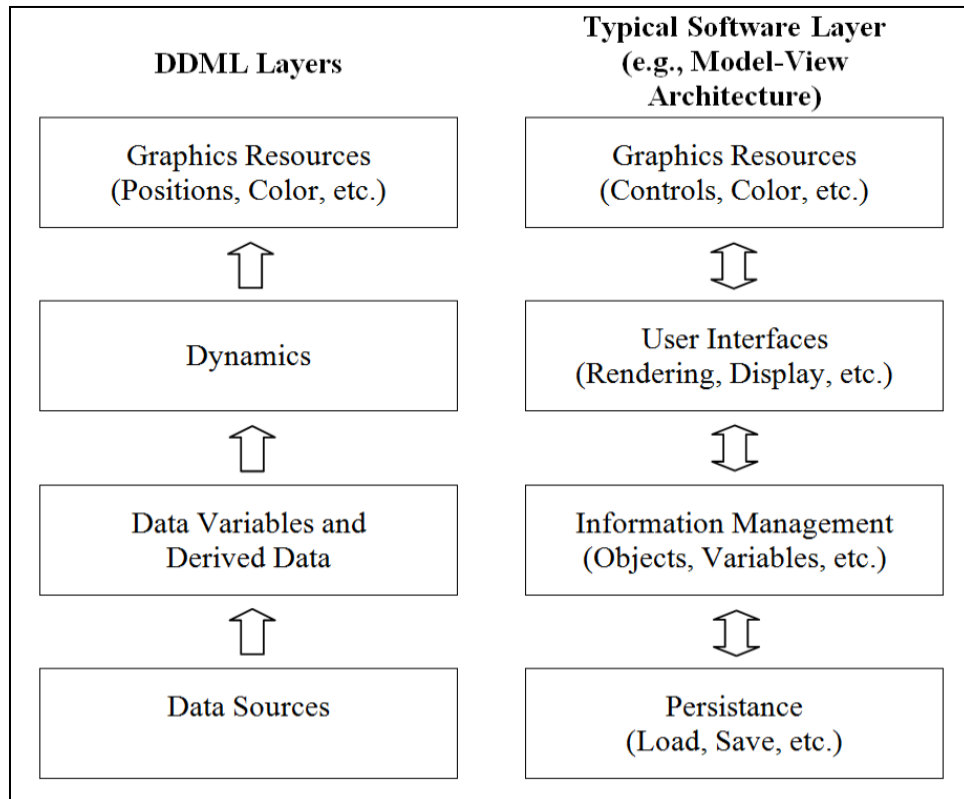

Figure 9-12. Layered Structure of DDML

Parallel to the typical software modules, DDML is also composed of layers (as depicted above in [Figure 9-12](#)) and as described below.

- a. Graphics Resources. This layer is similar to “graphics resources” of a typical software tool. In DDML, this layer includes the visual components of a data display system such

as sliders, plots, and strip charts as well as low-level graphic elements such as lines, rectangles, etc. Basic graphical shapes are modeled using a World Wide Web Consortium (W3C) recommended format called Scalable Vector Graphics (SVG).

- b. Dynamics. The dynamics layer handles the behavior of an object. It manages the rules and the variable instances attached to an object.
- c. Data Variables. Data variables are the links between the objects and the data sources. Data variables can be atomic or derived. Derived variables may use other derived or atomic variables in a mathematical expression.
- d. Data Sources. The last layer of the DDML architecture is the Data Sources layer. This layer handles various data sources such as text files, Open Database Connectivity (ODBC), network ports, and ports on data acquisition cards.

At each layer, the parameters used to describe each DDML element are divided into two groups: DDML sub-elements and custom parameters. The DDML sub-elements make up the most common and most necessary pieces of information needed to represent each element. They are stored as named sub-elements in DDML. Custom parameters are used to store any vendor-specific information that is not explicitly defined as a DDML sub-element. These parameters are stored as DDML “param” elements.

9.6.3 Data Display Markup Language Global Element Glossary

The DDML element names and descriptions can be seen in [Table 9-12](#).

<b>Table 9-12. Data Display Markup Language Global Element Glossary</b>	
<b>Element Name</b>	<b>Description</b>
mathml:apply	Defined in the mathml schema and used as a sub-element of variable in DDML, defines a variable as a function of other variables.
axis	A sub-element of a display object, represents an axis of any chart-type display object. It has a sub-element axisType that can be one of two values: VALUE or TIME. Other sub-elements allow the setting of min and max values, colors, grid line properties, etc.
barchart	A display object that shows one or more variables as vertical or horizontal bars whose lengths correspond to the values.
button	A display object that consists of an image or icon that, when clicked, can assign a value to a variable.
color	A commonly used sub-element of many DDML elements, it simply specifies the color of its parent object. All colors in DDML are stored as base-10 integers that are encoded as 0xRRGGBB.
comparisonOperator	Used in rules, defines the comparison between two values. Can be either GT (greater than), LT (less than), GTE (greater than or equal), LTE (less than or equal), EQ (equal), or NEQ (not equal).
custom_parameters	A sub-element of a display object, serves as the parent element of a group of param elements that specify all of the custom (vendor-specific) parameters for a particular display object.



**Table 9-12. Data Display Markup Language Global Element Glossary**

<b>Element Name</b>	<b>Description</b>
data_source	A pool-level data source that is available for use by any of the variables in the variable pool.
data_source_pool	Contains data_source child elements representing all of the data sources used by the various objects in the DDML file. Information about all data sources (files, db connections, etc.) is kept in the data source pool.
ddml	Root element of a DDML file describing a collection of data displays.
dial	A display object that consists of a circular or arc value axis and some sort of marker or needle that points to the current value along this axis. Example: a gauge or a compass.
display_objects	A sub-element of a model, serves as a container for all of the display objects in that model.
dynamics	A set of variable uses and rules used to define the dynamic behavior of a display object. The dynamicType sub-element describes the dynamic behavior while the variable_use and rules child elements define how variable values affect that behavior. A dynamicType of “builtin” is used for display objects that have implicit dynamic behavior, such as charts and sliders. Other possible values of dynamicType include: visibility, text, subdrawing, scale, scaleY, scaleX, rotate, relativeMoveY, relativeMoveX, pathMove, lineWidth, lineStyle, foregroundColor, fillUp, fillRight, fillLeft, fillDown, fillEffect, curveType, blink, backgroundColor, arcDirection, absoluteMoveX, absoluteMoveY, fillColor, edgeColor.
else	Part of a rule, specifies what to do if the criteria specified in the if element are false. The else element can be the parent of one or more additional rules, or can just specify a value or variable reference.
frequencyplot	A display object that is a chart in the frequency domain.
frequencyresponse	A display object that is a graph consisting of two value axes (frequency and magnitude) plotted against a single frequency axis.
grid	A table. The grid element is used to group several display objects (including other grids) together in a tabular layout. Each display sub-object’s location in the grid is specified with its gridRow and gridColumn elements.
hud	A display object that resembles a typical aircraft heads-up display that consists of three vertical axes (typically used for velocity, pitch, and altitude) and one horizontal axis (typically for heading). The center vertical axis rotates according to a fifth variable (typically roll). The variable_uses in the dynamics section are applied in this order: center vertical axis rotation (roll), center vertical axis (pitch), horizontal axis (heading), right vertical axis (altitude), left vertical axis (velocity).
if	Part of a rule, specifies a comparison between the current variable and some value.

**Table 9-12. Data Display Markup Language Global Element Glossary**

Element Name	Description
map	An area of a model that displays longitude/latitude map info. The coordinates of all child objects of a map are in decimal latitude/longitude values. For distance attributes (e.g., a circle's radius), degrees latitude are used as the measurement unit.
model	A container for data displays. Typically interpreted as a single screen or "page" of display objects. The model object defines its own coordinate system with the minX, minY, maxX, maxY, xDirection, and yDirection sub-elements. All sub-objects of a model are specified in coordinates that conform to the system defined by the model.
object	A generic display object. An "object" can be any display object not specified in the DDML definition, or can be used as the top-level element in a group of sub-objects.
param	Used to specify any parameter of a DDML element that is not explicitly specified elsewhere in the schema. These are commonly referred to as "custom parameters" and are mostly used for vendor-specific information.
piechart	A circular display object that shows the values of multiple variables as a percentage slice of their sum.
project	A collection of models.
radialchart	A display object that represents variable values as distances outward from a central point. A radial chart consists of two axes: a linear value axis and a circular axis. The circular axis can be either a time axis or a value axis. The type of the circular axis is controlled by its axisType sub-element, which can have a value of either "TIME" or "VALUE". If the value is "VALUE", then a series of xyPair objects will specify how the variables are paired. In each of these xyPairs, the X-value corresponds to the value in the circular axis direction, and the Y-value corresponds to the value in the radial axis direction.
rule	Specifies a change in a property (e.g., color, visibility) when a variable reaches a certain value or range of values. The ranges of values and resulting property values are specified with if, then, and else child elements.
rules	The parent element of a group of rule elements
slider	A display object that consists of some kind of indicator or icon that slides along a single value axis. A slider can be vertical or horizontal. Example: A "gauge" in Range View or a "fader" in Data Views.
stripchart	A display object that is essentially a line graph that plots values vs. time along a scrolling "paper" grid. A stripchart can be vertical or horizontal, and can scroll in any of the four directions (up, down, left, right). This is controlled by the scrollDirection sub-element. The scrollDirection element refers to the direction that the paper or background scrolls. For example, in a DataViews horizontal strip chart, the paper scrolls to the left while new values are plotted at the right edge of the graph. Thus, the scrollDirection is "left".

<b>Table 9-12. Data Display Markup Language Global Element Glossary</b>	
<b>Element Name</b>	<b>Description</b>
svg:svg	SVG is a W3C recommendation and is defined in its own schema. In DDML, the <svg> element is used as a sub-element of <object> to define a display object in terms of the basic shapes of which it is composed.
textual	A display object used for representing text and labels, including both static and dynamic text (such as annunciators). If the text is dynamic, the valuePosition sub-element specifies where the dynamic value is in relation to the static label. Use valuePosition="center" if there is no label. The valueFormat sub-element is a C printf-style format string that specifies the format of the dynamic value. For example valueFormat = "%4.2f" indicates that the value should be output as a floating-point value with a maximum width of 4 and with 2 decimal places.
then	Part of a rule, the then element specifies the value to set the attribute to if the criteria specified in the if element is true. The then element can specify either the desired value or a reference to a variable containing the desired value.
variable	A pool-level data variable that is available for use by any of the display objects in the DDML file.
variable_pool	Contains variable child elements representing all of the variables used by the various display objects in the DDML file.
variable_use	A child of the dynamics element, variable_use is used to specify which variable from the variable pool is used. The pool_ref attribute must refer to the ID attribute of a variable element from the variable_pool.
xychart	A display object that is a line or xy scatter plot of variables in the y axis vs. other variables in the x axis. The x,y variable pairs are specified with the xyPair sub-elements.
xyPair	A sub-element of certain display objects, it describes how a chart's variable_use items are paired. Each xVar and yVar sub-element must refer to the ID of a variable_use element in the display object's dynamics section.

## 9.7 Instrumentation Hardware Abstraction Language

The IHAL is a standard for describing and interacting with instrumentation hardware in a vendor-neutral way. The IHAL was reviewed and adopted into IRIG 106 to serve the purpose originally intended for the Airborne Hardware Attributes (H) group described in Subsection [9.5.12](#), which has never been implemented. The IHAL standard consists of both an XML-based language and an application programming interface (API) specification, each of which are explained in greater detail below.

The IHAL language standard exists only as an XML schema; it does not exist in the TMATS code name format described in Section [9.5](#). The IHAL XML language schema consists of a collection of XSD files that define the structure of valid IHAL documents. The schemas are

available [here](#). Additionally, a graphical depiction of the schema in HTML format is available [here](#). The HTML files are very large and will take time to download.

#### 9.7.1 Usage of External Schemas in IHAL

The IHAL XML schema makes use of three external XML schemas for describing concepts outside the scope of IHAL, such as data formats and engineering units. These schemas are not included with the IHAL schema and must be retrieved from the organization that produces them. [Table 9-13](#) lists these external schemas and the versions required for this release of IHAL.

<b>Table 9-13. IHAL External Schemas</b>			
<b>Standard</b>	<b>Version used by IHAL</b>	<b>Global Types/Sub-schemas used by IHAL</b>	<b>Organization's URL</b>
Metadata Description Language (MDL)	0.8.12	DerivedUnitType MeasurementsType DataStreamsType	<a href="http://www.inetprogram.org">http://www.inetprogram.org</a>
TMATS - XML Schema	106-17	TmatsPGroup.xsd TmatsRGroup.xsd	<a href="https://www.trmc.osd.mil/wiki/x/YIBMBw">https://www.trmc.osd.mil/wiki/x/YIBMBw</a>
eXtensible Instrumentation Definition Markup Language (XidML)	3.0	Network-TransportType	<a href="http://www.xidml.org/">http://www.xidml.org/</a>

#### 9.7.2 What is the Instrumentation Hardware Abstraction Language?

The central concept in IHAL is the configurable attributes (i.e., settings) that each device exposes to the user; however, IHAL is also capable of describing the environmental and physical attributes of each device, such as its size, shape, and operating conditions.

The IHAL describes instrumentation hardware at two levels.

- a. The “pool” level describes hardware according to its capabilities and configurability. The information in the IHAL pool is similar to the information found in a device’s marketing or engineering data sheet. A good way to think of the pool is to understand that each device in the pool can be uniquely identified by its model number.
- b. The “use” level describes a specific configuration of instrumentation hardware. At the use level, devices from the pool are put into a specific use. That is, they are connected to other devices, and their configurable attributes are set to specific values. A good way to think of the use level is to understand that each device at this level can be uniquely identified by its serial number.

#### 9.7.3 What is the IHAL API?

The IHAL vendor web services API enables IHAL to be used not only as a language for describing instrumentation hardware, but also as a command and query language for configuring instrumentation hardware. The API defines a set of functions that an instrumentation hardware vendor can implement to provide access to their configuration engine to external users and

applications. All inputs and outputs to the functions are properly formatted IHAL XML documents.

Implementing this API allows vendors to expose the functionality of their configuration engines in a vendor-neutral way, without disclosing the inner workings of their proprietary configuration logic. In this way, vendor-neutral, 3rd-party applications can be developed to configure the hardware of any vendor who implements the IHAL API. The developers of such 3rd- (or 1st-) party applications need not understand the inner workings of each vendor's configuration engine.

#### 9.7.4 How Can IHAL Be Used?

The potential uses of IHAL fall into two major categories: 1) IHAL as a description language, and 2) IHAL as a command language.

##### 9.7.4.1 IHAL as a Description Language

As a vendor-neutral, human-readable language for describing instrumentation hardware, IHAL provides a means for storing a permanent record of the devices used during a test and their settings during that test. This description will remain readable and relevant even if the hardware vendors radically change their file formats or cease to exist.

Additionally, providing such descriptions enables the development of vendor-neutral tools. The capabilities of these tools can range anywhere from simple visualization (e.g., instrumentation network and configuration visualization) to complex automated reasoning (e.g., automatically selecting and configuring devices from multiple vendors based on user-defined requirements).

##### 9.7.4.2 IHAL as a Command Language

The IHAL constructs that describe the current configuration of a device can also be used to issue a command to the device to change its configuration. When combined with the API (described above), this feature of IHAL enables multi-vendor instrumentation configuration from a single user interface without requiring vendors to share knowledge about the internal workings of their configuration engines.

#### 9.7.5 IHAL Glossary

Below is an alphabetical list of definitions of key elements in the IHAL XML language.

A

**accelerometer:** A specialization of the “transducer” element for describing accelerometers (pool-level).

**analogSignalConditioningCard:** A specialization of the “card” element for describing analog signal conditioning cards (pool-level).

**analogSignalConditioningChannel:** A specialization of the “customHardwareChannel” element for describing analog signal conditioning channels (pool-level).

**analogSignalConditioningFunction:** A specialization of the “customFunction” element for describing analog signal conditioning.

**analogSignalFilterFunction:** A specialization of the “customFunction” element for describing analog signal filtering (pool-level).

**analogToDigitalConversionFunction:** A specialization of the “customFunction” element for describing analog-to-digital conversion.

## B

**bridgeSensor:** A specialization of the “transducer” element for describing bridge sensors (pool-level).

**busMonitorCard:** A specialization of the “card” element for describing bus monitor cards.

**busMonitorChannel:** A specialization of the “customHardwareChannel” element for describing bus monitor channels (pool-level).

**busMonitorChannelUse:** A specialization of the “channelUse” element for bus monitors. This element includes an additional construct for defining a dataStreamUse associated with the channel.

**busMonitorFunction:** A specialization of the “customFunction” element for describing bus monitoring (pool-level).

## C

**calibrationTable:** A use-level element for describing the calibration table associated with a particular transducer or other instrument.

**card:** A specialization of the “instrument” element for describing cards. A card in IHAL is an instrument that cannot operate stand-alone. It must be connected to another instrument in order to function.

**channelUse:** A specific implementation of a channel from the instrument pool. The channelUse description references a channel from the pool, specifies a specific channel number, and assigns values to settings on that channel.

**chargeAmplifierSensor:** A specialization of the “transducer” element for describing charge amplifier sensors (pool-level).

**configuration:** Container for multiple instrumentation graphs. Defines a single configuration or project.

**connection:** A use-level element used to describe a connection between two instruments in an instrumentationGraph.

**currentExcitationFunction:** A specialization of the “customFunction” element for describing current excitation (pool-level).

**currentLoopOutputSensor:** A specialization of the “transducer” element for describing current loop output sensors (pool-level).

**customAttribute:** A pool-level element for defining a generic attribute associated with a function. Each attribute may be either configurable or fixed, and may be either numeric, string, Boolean, or reference. If configurable, the attribute element will define which values are valid. Each specialized function description in IHAL will contain specializations of the “customAttribute” element for specific attributes such as “gain”, “offset”, etc.

**customFunction:** A pool-level element for defining generic instrumentation functions that don't fit into one of the specific specializations. A function may be composed of 0 or more attributes and 0 or more sub-functions.

**customHardwareChannel:** A pool-level element for describing a generic hardware channel that does not fit into any of the specific specializations. A channel contains a "multiplicity" element that defines how many identical channels the device has. A channel is composed of one or more functions.

D

**dataRecorderFunction:** Specialization of the "customFunction" element (pool-level). This is a channel-level function for describing the recording of data from a specific source. See also recorderReproducerFunction.

**dataRecordingChannel:** Specialization of the "customHardwareChannel" element for describing a data recorder channel (pool-level).

**dataStreamPool:** Contains the global list of data streams and buses. This element makes use of constructs from the integrated Network Enhanced Telemetry (iNET) program's MDL.

**dataStreamUse:** A use-level element used to define which measurements from a data stream are to be sampled by a bus monitor.

**dau:** A specialization of the "instrument" element for describing data acquisition units (pool-level).

**dauFunction:** Specialization of the "customFunction" element for describing the functions performed by a data acquisition unit (pool-level).

E

**errorList:** Top-level container for the IHAL error schema. An errorList may be returned as a response to any API function call.

F

**formatUse:** A specific implementation of a data format from the instrument pool. The formatUse element references a data format from the pool, specifies a format number, assigns values to settings associated with that format, and defines the measurements encoded in the format.

H

**highLevelVoltageSensor:** A specialization of the "transducer" element for describing high-level voltage sensors (pool-level).

I

**ihal:** The top-level element in a complete IHAL description

**instrument:** A pool-level element for describing a device that does not fit into one of the specific specializations. The pool-level instrument element defines the physical attributes of the hardware, the functionality it provides, and the settings available.

**instrumentationGraph:** A set of interconnected instrumentation hardware (instrumentUse elements). Separate instrumentationGraph elements could be used to describe the airborne system vs. the ground system, for example.

**instrumentPool:** Container for all pool-level device descriptions. The instrumentPool contains descriptions of all available instruments.

**instrumentUse:** A specific implementation of an instrument from the pool. The instrumentUse description references an instrument from the pool and assigns specific values to settings.

L

**lvdtRvdtSensor:** A specialization of the “transducer” element for describing linear/rotary variable differential transformers (pool-level).

M

**masterControllerFunction:** Specialization of the “customFunction” element for describing the functionality of a master controller (pool-level).

**measurementPool:** Contains a global list of measurements.

P

**potentiometricVoltageDivider:** A specialization of the “transducer” element for describing potentiometric voltage dividers (pool-level).

**programmingStatus:** A use-level element that describes the current status of programming the current configuration to the physical hardware. Values may be either “COMPLETE”, “IN\_PROGRESS”, “ERROR”, or “NOT\_STARTED”.

R

**recorderReproducer:** A specialization of the “instrument” element for describing a recorder/reproducer (pool-level).

**recorderReproducerFunction:** A specialization of the “customFunction” element for describing the function of recording/reproducing data associated with one or more channels to/from some medium.

**restrictedAttribute:** A use-level element that redefines the set of valid values for a configurable attribute from the pool. Restricted attributes are used whenever the valid values for a setting change as a result of the current configuration.

**resistanceSensor:** A specialization of the “transducer” element for defining resistance sensors (pool-level).

**rtdSensor:** A specialization of the “transducer” element for describing resistance temperature detectors (pool-level).

S

**setAttribute:** A use-level element that assigns a value to a configurable attribute from the pool.

**statusDataFunction:** Specialization of the “customFunction” element for describing the function of emitting status words (pool-level).



**strainGauge:** A specialization of the “transducer” element for describing strain gauges (pool-level).

**sstDataEncoderFunction:** A specialization of the “customFunction” element for describing a serial streaming telemetry (SST) data encoder.

**sstDataFormat:** Pool-level concept for describing an SST format that may be created by an instrument. Formats in IHAL are similar to channels in that they have a multiplicity and are composed of functions.

**sstFormatUse:** A specialization of the “formatUse” element for describing PCM output formats. sstFormatUse makes use of TMATS XML constructs.

## T

**thermistor:** A specialization of the “transducer” element for describing thermistors (pool-level).

**thermocouple:** A specialization of the “transducer” element for describing thermocouples (pool-level).

**tmNSDataEncoderFunction:** Specialization of the “customFunction” element for describing the functionality of a Telemetry Network Standard (TmNS) data encoder (pool-level).

**tmNSDataFormat:** Pool-level concept for describing a TmNS data format that may be created by an instrument. Formats in IHAL are similar to channels in that they have a multiplicity and are composed of functions.

**transducer:** A specialization of the “instrument” element for describing generic transducers (pool-level)

## U

**unitsPool:** Container for a global list of engineering units. Units can be built by combining other units and SI units. Unit descriptions make use of constructs from the iNET program’s MDL.

## V

**voltageAmplificationFunction:** A specialization of the “customFunction” element for describing voltage amplification (pool-level).

**voltageExcitationFunction:** A specialization of the “customFunction” element for describing voltage excitation (pool-level).

## X

**xidMLNetworkDataEncoderFunction:** A specialization of the “customFunction” element for describing the functionality of a non-TmNS network data encoder (pool-level).

**xidMLNetworkDataFormat:** Pool-level concept for describing a non-TmNS network data format that may be created by an instrument. Formats in IHAL are similar to channels in that they have a multiplicity and are composed of functions.

**xidMLNetworkFormatUse:** A specialization of the “formatUse” element for describing non-TmNS network data formats. This element makes use of constructs from XidML.

## 9.7.6 Complete IHAL API Specification

### 9.7.6.1 API Implementation Requirements

The IHAL API must be implemented as a RESTful web service. All functions must have a common base path (e.g., <http://10.10.1.1:8080/ihalapi/>). This base path is referred to as “<Vendor API Location>“ in this document.

All inputs are provided as the payload of the function call, with no named parameters or URL encoding. That is, inputs will NOT be part of the URL (e.g., <http://.../?ihal=<ihal>...> is NOT allowed).

### 9.7.6.2 Errors

All functions in the below specification may optionally return an <ihal:errorList> element instead of the defined response. The error list is intended to provide the user with a description of problems encountered if the requested function could not be performed.

### 9.7.6.3 API Functions

The following sections describe the functions that must be included as part of any IHAL API implementation.

#### 9.7.6.3.1 Retrieve a Vendor’s Pool

This method is used by a client to retrieve some part of a vendor’s pool description. There are multiple URLs for this function to retrieve different parts of the pool, as shown in [Table 9-14](#).

<b>Table 9-14. Retrieve a Vendor’s Pool</b>	
<b>URL</b>	<Vendor API Location>/pool/units to retrieve the units pool
	<Vendor API Location>/pool/instrument to retrieve the instrument pool
	<Vendor API Location>/pool/measurement to retrieve the global measurement list
	<Vendor API Location>/pool/measurement/<deviceID> to retrieve the list of measurements available to a particular device (e.g., a data encoder)
	<Vendor API Location>/pool/dataStream to retrieve the global list of data streams (e.g., buses)
	<Vendor API Location>/pool/dataStream/<deviceID> to retrieve the global list of data streams (e.g., buses) available to a particular device
<b>HTTP Verb</b>	GET
<b>Function Input</b>	None
<b>Return Value</b>	Complete IHAL <instrumentPool>, <unitsPool>, <measurementPool>, or <dataStreamPool> element.

#### 9.7.6.3.2 Retrieve the List of Available Configurations

This function queries the web service for a list of existing instrumentation configurations and is described in [Table 9-15](#).

<b>Table 9-15. Retrieve the List of Available Configurations</b>	
<b>URL</b>	<vendor API Location>/configurations/
<b>HTTP Verb</b>	GET
<b>Function Input</b>	None
<b>Return Value</b>	A partial <ihal> specification containing 0 or more EMPTY <configuration> elements, each with only the basic required information. No pools should be returned.

#### 9.7.6.3.3 Retrieve a Specific Configuration

This function uses the ID of a configuration returned from the previous function call to request the complete description of that configuration. It is illustrated in [Table 9-16](#).

<b>Table 9-16. Retrieve a Specific Configuration</b>	
<b>URL</b>	<vendor API Location>/configurations/<configurationID>. <configurationID> contains a unique identifier returned as the “id” attribute from a call to “Retrieve a list of Configurations”
<b>HTTP Verb</b>	GET
<b>Function Input</b>	None
<b>Return Value</b>	A complete IHAL <configuration> element

#### 9.7.6.3.4 Change the Value of a Configurable Attribute

This function is used to change the values of settings on a particular device, as shown in [Table 9-17](#). The desired setting changes are passed via IHAL, and a description of everything that has changed as a result of these setting changes is returned as an IHAL description.

<b>Table 9-17. Change the Value of a Configurable Attribute</b>	
<b>URL</b>	<vendor API Location>/configurations/<configurationID>/<configurationID> contains a unique identifier returned as the “id” attribute from a call to “Retrieve a list of Configurations”
<b>HTTP Verb</b>	PUT
<b>Function Input</b>	A partial <configuration> element. This element contains only the settings that the user wishes to modify.
<b>Return Value</b>	The impact: A partial IHAL <configuration> element containing only the new settings for everything that has changed: <ul style="list-style-type: none"> <li>• The new values for the settings the user requested (may or may not match the original request);</li> <li>• Any additional settings that changed as a result;</li> <li>• Any attribute “restrictions” that changed as a result.</li> </ul>

#### 9.7.6.3.5 Create a New Configuration

This function is used to create a new configuration in the vendor’s system. It is described in [Table 9-18](#). A partial or complete IHAL “configuration” element is passed as input, and then

the vendor responds with a validated “configuration” element that matches (as closely as possible) the input. The vendor may change use-level IDs.

<b>Table 9-18. Create a New Configuration</b>	
<b>URL</b>	<vendor API Location>/configurations/
<b>HTTP Verb</b>	POST
<b>Function Input</b>	A partial or complete <configuration> element.
<b>Return Value</b>	A validated <configuration> description that matches (as closely as possible) the input <configuration>. Use-level ID values may change.

#### 9.7.6.3.6 Add a Device to a Configuration

This function is used to add a device from the pool to an existing configuration in the vendor’s system. The function is depicted in [Table 9-19](#). A partial or complete IHAL “instrumentUse” element is passed as input, and then the vendor responds with a valid “configuration” element that includes the new device. The vendor may change use-level IDs.

<b>Table 9-19. Add a Device to a Configuration</b>	
<b>URL</b>	<vendor API Location>/configurations/<configurationID>/devices
<b>HTTP Verb</b>	POST
<b>Function Input</b>	A partial or complete <instrumentUse> element.
<b>Return Value</b>	A valid <configuration> description that includes the new device. Use-level ID values may change.

#### 9.7.6.3.7 Remove a Device from a Configuration

This function is used to remove an instrumentUse from an existing configuration in the vendor’s system. It is illustrated in [Table 9-20](#). The ID of the instrumentUse element is included in the URL, and the HTTP “DELETE” verb tells the system to remove that device. The vendor must respond with a valid configuration description, with the device removed.

<b>Table 9-20. Remove a Device from a Configuration</b>	
<b>URL</b>	<vendor API Location>/ configurations/<configurationID>/devices/<instrumentUseID>
<b>HTTP Verb</b>	DELETE
<b>Function Input</b>	None
<b>Return Value</b>	A valid <configuration> description with the device removed

#### 9.7.6.3.8 “Program” the Hardware

This function is used to tell the vendor’s configuration engine to load a specific configuration onto the affected hardware. It is illustrated in [Table 9-21](#). The vendor responds with a <configuration> description that includes updated values for the programming status.

<b>Table 9-21. “Program” the Hardware</b>	
<b>URL</b>	<vendor API Location>/ configurations/<configurationID>/programRequest

<b>HTTP Verb</b>	POST
<b>Function Input</b>	None
<b>Return Value</b>	A partial <configuration> description with the current programming status of affected devices updated.

#### 9.7.6.3.9 Add a New format to a Data Encoder

This function is used to add a new data format to a data encoder. This can be either a PCM (SST) format or a non-TmNS network format. The client sends a partial or complete description of the format, and the vendor's service responds with an updated <configuration> element containing ONLY items that have changed (including the addition of the new format). The function is shown in [Table 9-22](#).

<b>Table 9-22. Add a New Format to a Data Encoder</b>	
<b>URL</b>	<vendor API Location>/ configurations/<configurationID>/<instrumentUseID>/formats
<b>HTTP Verb</b>	POST
<b>Function Input</b>	A complete or partial format "use" description (i.e., sstFormatUse or xidMLNetworkFormatUse)
<b>Return Value</b>	An updated <configuration> element containing the new format as well as any settings in the configuration that have changed as a result.

#### 9.7.6.3.10 Add a Measurement to an Existing Format

This function is used to add a new measurement to an existing data format. The function is illustrated in [Table 9-23](#). The input uses either a XidML <Mapping> element or a TMATS <Measurement> element to describe the measurement and where it should be placed in the format. The vendor's service responds with a <configuration> element that contains a complete description of the affected format as well as any settings changes that have occurred as a result.

<b>Table 9-23. Add a Measurement to an Existing Format</b>	
<b>URL</b>	<vendor API Location>/ configurations/<configurationID>/<formatUseID>/measurements
<b>HTTP Verb</b>	POST
<b>Function Input</b>	A description of the measurement and its location in the format. This will be either a XidML <Mapping> element or a TMATS-XML <Measurement> element.
<b>Return Value</b>	An updated <configuration> element containing the modified format as well as any settings in the configuration that have changed as a result.

#### 9.7.6.3.11 Remove a Measurement from a Format

This function is used to remove a measurement from an existing data format. The function is illustrated in [Table 9-24](#). The client specifies the ID of the measurement in the URL. The vendor's service must remove ALL instances of this measurement from the specified format. The service must then respond with a <configuration> element that contains a complete description of the affected format as well as any settings changes that have occurred as a result.

<b>Table 9-24. Remove a Measurement From a Format</b>	
<b>URL</b>	<vendor API Location>/ configurations/<configurationID>/<formatUseID>/<measurementID>
<b>HTTP Verb</b>	DELETE
<b>Function Input</b>	None
<b>Return Value</b>	An updated <configuration> element containing the modified format as well as any settings in the configuration that have changed as a result.

## **APPENDIX 9-A**

### **Application of the Telemetry Attributes Transfer Standard**

Elements of the telemetry attributes transfer process allow for the interchange of telemetry attributes between vehicle instrumentation organizations (the source) and the telemetry ground stations (the destination). Interchange may also take place between ranges. The following are typical elements of this process:

- a. Data entry system
- b. Source database
- c. Export program
- d. Interchange medium [this standard]
- e. Import program
- f. Destination database
- g. Telemetry setup system
- h. Telemetry processing equipment.

[Figure A-1](#) depicts these elements, which are defined after the figure.

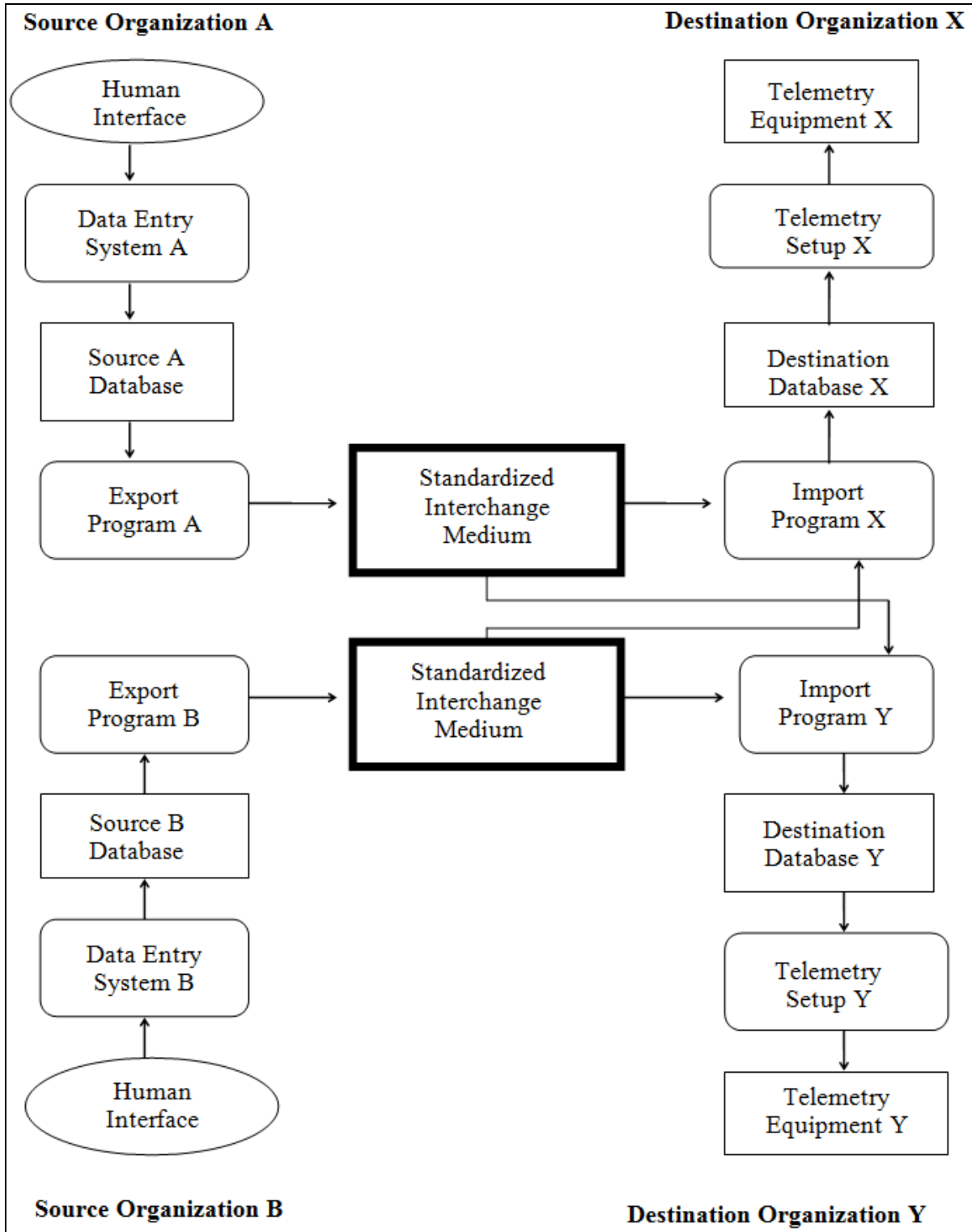

Figure A-1. Typical Elements of the Telemetry Attributes Transfer Process

### A.1. Data Entry System

The data entry system is the source organization's human interface where telemetry attributes are entered into a computer-based system (not affected by this standard).



## **A.2. Source Database**

The source database is where telemetry attributes are maintained in a form appropriate to the local organization's needs (not affected by this standard).

## **A.3. Export Program**

The export program converts the telemetry attributes from the source database format to the format defined by this standard and stores them on the interchange medium.

## **A.4. Interchange Medium**

The interchange medium contains the telemetry attributes being transferred from the source organization to the destination organization. Format and contents are defined by this standard.

## **A.5. Import Program**

The import program reads the standardized interchange medium and converts the attributes to the destination database format in accordance with local needs, system characteristics, and limitations.

## **A.6. Destination Database**

The destination database is where telemetry attributes are maintained in a form suitable to the local ground station's needs (not affected by this standard).

## **A.7. Telemetry Setup System**

The telemetry setup system accesses the destination database to load the telemetry processing equipment (not affected by this standard).

## **A.8. Telemetry Processing Equipment**

The telemetry processing equipment is where the attributes will ultimately be used to properly handle the data being transmitted (not affected by this standard).

The interchange medium is intended as a standard means of information exchange. The source and destination organizations are not constrained by this standard as to how the attributes are stored, viewed, used, or maintained.

To use the attribute transfer standard, import and export software must be developed. Once in place, these programs should eliminate the need for test item or project-specific software at either the supplying (source) organizations or the processing (destination) organizations.

This page intentionally left blank.

## APPENDIX 9-B

### Telemetry Attributes Transfer Standard Cover Sheet

Each attribute transfer file (disk or tape) should be accompanied by a cover sheet describing the originating agency's computer system used to construct the attribute file. The recommended format for this cover sheet is given below as [Figure B-1](#).

Telemetry Attributes Transfer Standard	
Date:	MM\DD\YY
From:	Name
	Address
	Telephone
To:	Name
	Address
	Telephone
Originating computer system:	
Computer make and model:	
Medium characteristics:	
Description:	
Comments:	

Figure B-1. Sample Cover Sheet for Attribute Transfer Files

This page intentionally left blank.

## APPENDIX 9-C

### Telemetry Attributes Transfer Standard Format Example

#### C.1. Introduction

The following example is for illustrative purposes and is by no means a complete attributes file; it is representative of the types of information likely to be transferred. Many attributes are purposely omitted to simplify the example. In some of the groups, only those entries necessary to link to other groups are provided. Attributes that link the various groups together are indicated in **boldface**.

#### C.2. Overview of Example

Selected attributes are described in text form as an aid to following the example. All text that describes the example is *printed in italics*. All text that is part of the example file is printed in plain text.

The example file being transferred consists of the attributes of a single RF data source and a stored data source containing two channels of data. The RF data source is a PCM signal, which contains an embedded asynchronous wave train. The two recorded channels of data are PCM signals: one is an aircraft telemetry stream, and the other is a radar data telemetry stream. [Figure C-1](#) shows the example file in terms of the attribute groups and their interrelationships. Refer to the attribute tables while reviewing the example.

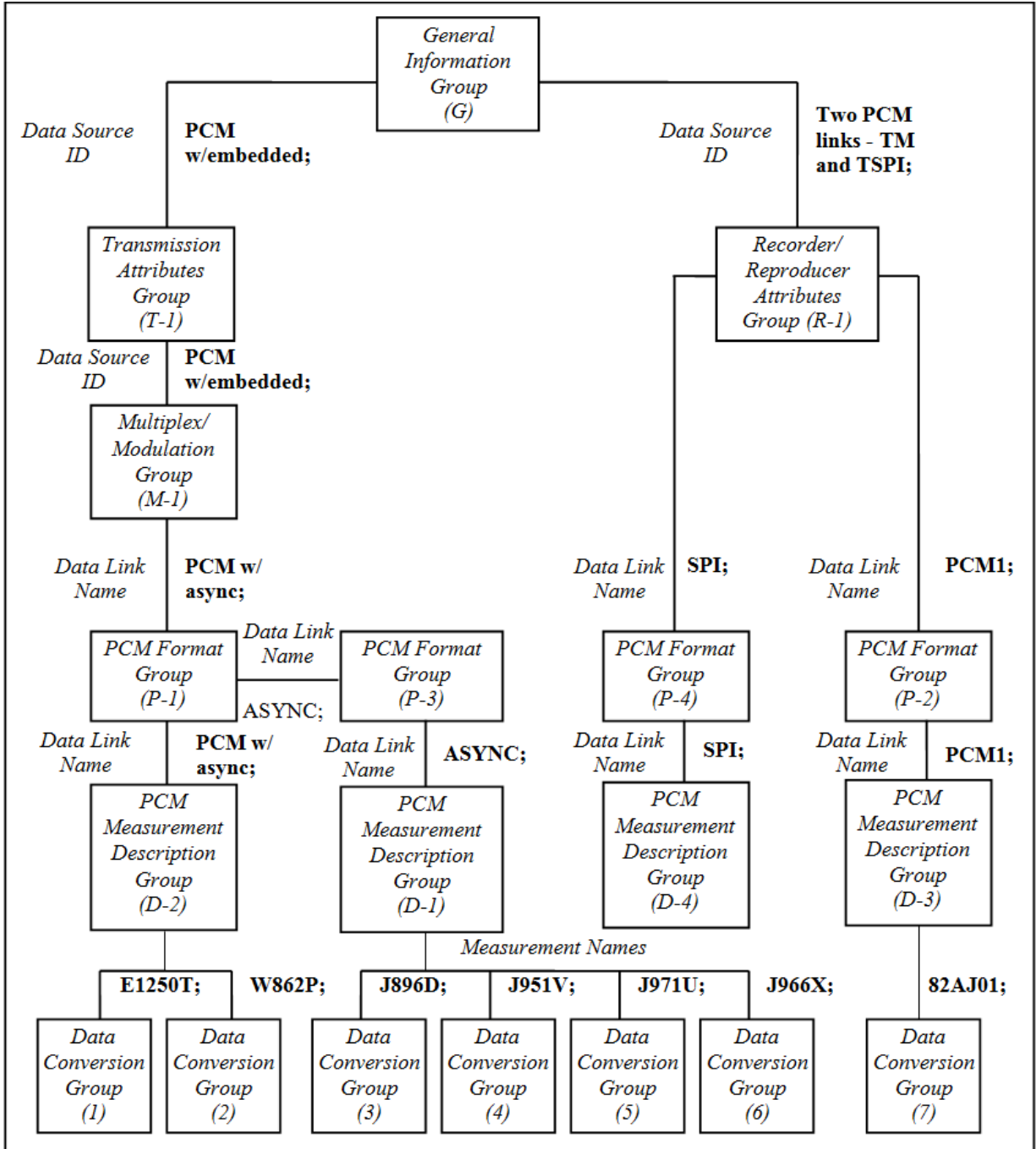

Figure C-1. Group Linkages

General Information Group (G)

Program name, test name, origination date, revision number: 0, test number: 13.

G\PN: TMATS example; G\TA: Wright Flyer; G\OD: 07-12-1903; G\RN:0; G\TN:13;  
 G\POC1-1: Wilbur; G\POC2-1: Bikes,LTD; G\POC3-1: Dayton; G\POC4-1: 555-1212;

*Live data source.*

**G\DSI-1:PCM w/embedded; G\DST-1:RF;**

*Data storage source.*

**G\DSI-2:Two PCM links - TM & TSPI; G\DST-2:STO;**  
G\COM: I hope this flies.; G\POC1-2: Orville;  
G\POC2-2:Bikes,LTD; G\POC3-2: Dayton; G\POC4-2: 555-1212;

Transmission Attributes Group (T-1)

*Frequency: 1489.5, RF bandwidth: 100, data bandwidth: 100; not encrypted, modulation type: FM, total carrier modulation: 500, no subcarriers, transmit polarization: linear.*

**T-1\ID:PCM w/embedded; T-1\RF1:1489.5; T-1\RF2:100; T-1\RF3:100;**  
T-1\RF4:FM; T-1\RF5:500; T-1\SCO\N:NO; T-1\AN2:LIN;  
T-1\AP\POC1: Pat Tern; T-1\AP\POC2:Transmissions,Inc.;  
T-1\AP\POC3:Amityville,NY; T-1\AP\POC4:800-555-1212;

Recorder-Reproducer Attributes Group (R-1)

**R-1\ID:Two PCM links - TM & TSPI;**  
R-1\R1:Recorded Data; R-1\TC1:MD;

*Two channels of data, manufacturer: ZZ; model: 13, original: yes.*

R-1\RI1:ZZ; R-1\RI2:13;R-1\N:2; R-1\RI3:Y;  
R-1\RI4:07-12-2011-07-55-59; R-1\POC1:Mr. Tenn; R-1\POC2:Data Creations;  
R-1\POC3:Anywhere,Ttown; R-1\POC4:555-1212;

*Channel ID 2 contains aircraft telemetry PCM (w/subframe fragmented)*

R-1\TK1-1:2;  
R-1\DSI-1:PCM w/subframe fragmented;  
R-1\CDT-1:PCMIN; **R-1\CDLN-1:PCM1;**

*Channel ID 4 contains Space Position Information via PCM link*

R-1\TK1-2:4; R-1\DSI-2:Space Position Information;  
R-1\CDT-2:PCMIN; **R-1\CDLN-2:SPI;**

Multiplex/Modulation Group (M-1)

*Baseband type: PCM, modulation sense: POS, baseband data: PCM, low pass filter type: constant amplitude*

**M-1\ID:PCM w/embedded; M-1\BB1:PCM; M-1\BB2:POS; M-1\BSG1:PCM;**  
M-1\BSF2:CA;  
**M-1\BB\DLN:PCM w/async;**

---

PCM Format Attributes Groups (P)

P-1 is a live PCM signal and contains the asynchronous wave train (see [Table C-1](#)).

P-2 is a recorded signal (see [Table C-2](#)).

P-3 is the asynchronous wave train (see [Table C-3](#)).

P-4 is a recorded signal.

Table C-1. PCM Format for PCM w/ASYNC																												
	Sync	1	2	3	4	5	6	7	8	9	10	11	12	13	14	15	...	39	40	41	42							
1																												
2	20	ID  C o u n t e r					Embedded Format (Words 6-10)				8 B i t s	12 B i t s							a a a a a a a a a a a a									
3	bits																											
4																												
5																												
6																												
7																												
8																												
...																												
...																												
...																												
16																												
<p>Major frame characteristics:                      One major frame = 16 minor frames                      Word lengths = 10 bits (default value) except Word 10 has 8 bits and Word 11 has 12 bits</p> <p>a = measurement E1250T in word position 39                      b = measurement W862P in word position 42, frame position 8.</p> <p>PCM Format Group = P-1                      PCM Measurement Description Group = D-2                      Data Link Name = PCM w/async</p>																												



**Table C-2. PCM Format for PCM1**

	Sync	1	2	3	...	12	13	14	...	113	114	...	120	121	122	...	276		
1							ID  C o u n t e r												
2	30 bits																		
3																			
4																			
5									M					L					
...																			
...																			
32														6 Bits		4 Bits			
...																			
...																			
37									M					L					
...																			
...																			
64																			

Major frame characteristics:

One major frame = 64 minor frames

ID counter counts 0 - 63

Word lengths = 10 (default value) except Word 121 has 6 bits and Word 122 has 4 bits

Measurement 82AJ01 is 16 bits, which is fragmented with the 10 msbs indicated as M and the 6 lsbs as L.

Measurement 82AJ01 occurs twice in the major frame.

The first location is in word positions 113 and 121, frame position 5.

The second location is in word positions 113 and 121, frame position 37.

PCM Format Group = P-2

PCM Measurement Description Group = D-3

Data Link Name = PCM1

**Table C-3. PCM Format for ASYNC**

	Sync	1	2	3	...	11	...	14	...	20	...	29	...	33	...	39	...	45	46	47	48	49	
<b>1</b>	16 B i t s	ID C o u n t e r	a	b	...	a	...	c	...	a	...	a	...	a	...		...			a			
<b>2</b>			a		...	a	...		...	a	...	a	...	a	...	c	...				a		
<b>3</b>			a		...	a	...		...	a	...	a	...	a	...		...	d			a		

Major frame characteristics:

One major frame = 3 minor frames

Word lengths = 16 bits (default value)

a = measurement J971U, supercommutated in word positions 2, 11, 20, 29, 33, and 47

b = measurement J951V in word position 3, frame position 1

c = measurement J896D in two locations: word position 14, frame position 1 and word position 39, frame position 2

d = measurement J966X in word position 45, frame position 3

PCM Format Group = P-3

PCM Measurement Description Group = D-1

Data Link Name = ASYNC

*(Start of P-1)*

*Live PCM signal (host wave train): Class I*

**P-1\DLN:PCM w/async; P-1\D1:NRZ-L; P-1\D2:44000; P-1\D3:U;  
P-1\D4:N; P-1\D6:N; P-1\D7:N; P-1\TF:ONE;**

*10 bits default word length, 16 minor frames/major frame, 43 words/frame*

P-1\F1:10; P-1\F2:M; P-1\F3:NO; P-1\MF\N:16; P-1\MF1:43;  
P-1\MF2:440; P-1\MF3:FPT; P-1\MF4:20;  
P-1\MF5: 01111010011010110001; P-1\SYNC1:1; P-1\SYNC2:0;  
P-1\SYNC3:1;P-1\SYNC4:0;

*Word position #10, 8 bits, Word position #11, 12 bits*

P-1\MFW1-1:10; P-1\MFW2-1:8; P-1\MFW1-2:11; P-1\MFW2-2:12;

*One subframe ID counter in word position 1*

P-1\ISF\N:1; P-1\ISF1-1:1; P-1\ISF2-1:ID; P-1\IDC1-1:1;

*msb starting bit location: 7, ID counter length: 4*

P-1\IDC3-1:7; P-1\IDC4-1:4; P-1\IDC5-1:M;  
P-1\IDC6-1:0; P-1\IDC7-1:1; P-1\IDC8-1:15; P-1\IDC9-1:16;  
P-1\IDC10-1:INC;

*Asynchronous embedded wave train information*

*Data Link Name (to be referenced in the format definition of the asynchronous wave train) is ASYNC.*

*Five contiguous minor frame word positions starting at location 6.*

P-1\AEF\N:1; **P-1\AEF\DLN-1:ASYNC**; P-1\AEF1-1:5; P-1\AEF2-1:CW;  
P-1\AEF3-1-1:6;

*(End of P-1)*

---

*(Start of P-2)*

*Recorded PCM signal format attributes.*

*Data Link Name is PCM1, Data Format is NRZ-L, Bit rate is 2 Mbit/sec, Unencrypted, Normal polarity, class I, Common word length is 10, msb first, No parity, 64 minor frames per major frame, 277 words per minor frame, Sync pattern length is 30. Word position 121 is 6 bits. Word position 122 is 4 bits.*

**P-2\DLN:PCM1**; P-2\D1:NRZ-L; P-2\D2:2000000; P-2\D3:U; P-2\D4:N;  
P-2\TF:ONE; P-2\F1:10; P-2\F2:M; P-2\F3:NO; P-2\MF\N:64;  
P-2\MF1:277; P-2\MF4:30; P-2\MF5:101110000001100111110101101011; P-2\SYNC1:1;  
P-2\MFW1-1:121; P-2\MFW2-1:6; P-2\MFW1-2:122; P-2\MFW2-2:4;

*One subframe ID counter named 1. Sync type is ID counter. ID counter location is 13. ID counter msb location is 5. ID counter length is 6. ID counter transfer order is msb first. ID counter initial value is 0. ID counter initial frame is 1. ID counter end value is 63. ID counter end frame is 64. ID counter is increasing.*

P-2\ISF\N:1; P-2\ISF1-1:1; P-2\ISF2-1:ID; P-2\IDC1-1:13;  
P-2\IDC3-1:5; P-2\IDC4-1:6; P-2\IDC5-1:M;  
P-2\IDC6-1:0; P-2\IDC7-1:1; P-2\IDC8-1:63; P-2\IDC9-1:64;  
P-2\IDC10-1:INC;

*(End of P-2)*

---

*(Start of P-3)*

*Asynchronous wave train PCM format attributes.*

*Data Link Name: ASYNC*

*Class I, Common word length: 16, lsb transfer order, no parity, 3 minor frames per major frame, 50 words/minor frame, 800 bits per minor frame, fixed pattern synchronization, 16 bit sync pattern.*

**P-3\DLN:ASYNC;** P-3\TF:ONE; P-3\F1:16; P-3\F2:L; P-3\F3:NO;  
P-3\MF\N:3; P-3\MF1:50; P-3\MF2:800; P-3\MF3:FPT; P-3\MF4:16;  
P-3\MF5: 1111100110110001; P-3\SYNC1:1;

*ID counter in word position 1.*

P-3\ISF\N:1; P-3\ISF1-1:2; P-3\ISF2-1:ID; P-3\IDC1-1:1;  
P-3\IDC3-1:15; P-3\IDC4-1:2; P-3\IDC5-1:L;  
P-3\IDC6-1:0; P-3\IDC7-1:1; P-3\IDC8-1:2; P-3\IDC9-1:3;  
P-3\IDC10-1:INC;

*(End of P-3)*

---

*(Start of P-4)*

**P-4\DLN:SPI;**

*(End of P-4)*

---

*PCM Measurement Description (D)*

*D-1 contains the measurements that make up the asynchronous wave train,*

*D-2 contains the measurements that make up the live PCM signal (that hosts the asynchronous wave train),*

*D-3 contains the measurements that make up one of the recorded PCM signals, and*

*D-4 contains the measurements that make up the other recorded PCM signal.*

---

*(Start of D-1)*

*Asynchronous Wave Train: One measurement list, 4 measurements*

**D-1\DLN:ASYNC;** D-1\ML\N:1; D-1\MLN-1:JUST ONE; D-1\MN\N-1:4;

*Measurement Name: J896D, lsb first.*

*2 locations: word 14, frame 1 and word 39, frame 2.*

**D-1\MN-1-1:J896D;** D-1\MN3-1-1:L; D-1\LT-1-1: WDFR;  
D-1\MML\N-1-1:2; D-1\MNF\N-1-1-1:1; D-1\WP-1-1-1-1:14; D-1\WI-1-1-1-1:0;  
D-1\FP-1-1-1-1:1; D-1\FI-1-1-1-1:0; D-1\WFM-1-1-1-1:FW; D-1\MNF\N-1-1-2:1;  
D-1\WP-1-1-2-1:39; D-1\WI-1-1-2-1:0; D-1\FP-1-1-2-1:2; D-1\FI-1-1-2-1:0;  
D-1\WFM-1-1-2-1:FW;

*Measurement Name: J951V, lsb first, default parity, word 3, frame 1.*

**D-1\MN-1-2:J951V;** D-1\MN1-1-2:DE; D-1\MN2-1-2:D; D-1\MN3-1-2:L;  
D-1\LT-1-2: WDFR; D-1\MML\N-1-2:1; D-1\MNF\N-1-2-1:1; D-1\WP-1-2-1-1:3;  
D-1\WI-1-2-1-1:0; D-1\FP-1-2-1-1:1; D-1\FI-1-2-1-1:0;  
D-1\WFM-1-2-1-1:1111111100000000;

*Measurement Name: J971U, lsb first,*

*supercommutated at 6 word positions: 2, 11, 20, 29, 33, and 47.*

**D-1\MN-1-3:J971U**; D-1\MN1-1-3:DE; D-1\MN2-1-3:D; D-1\MN3-1-3:L;  
D-1\LT-1-3: WDFR; D-1\MML\N-1-3:6;  
D-1\MNF\N-1-3-1:1; D-1\WP-1-3-1-1:2; D-1\WI-1-3-1-1:0; D-1\FP-1-3-1-1:1;  
D-1\FI-1-3-1-1:1; D-1\WFM-1-3-1-1:FW;  
D-1\MNF\N-1-3-2:1; D-1\WP-1-3-2-1:11; D-1\WI-1-3-2-1:0; D-1\FP-1-3-2-1:1;  
D-1\FI-1-3-2-1:1; D-1\WFM-1-3-2-1:FW;  
D-1\MNF\N-1-3-3:1; D-1\WP-1-3-3-1:20; D-1\WI-1-3-3-1:0; D-1\FP-1-3-3-1:1;  
D-1\FI-1-3-3-1:1; D-1\WFM-1-3-3-1:FW;  
D-1\MNF\N-1-3-4:1; D-1\WP-1-3-4-1:29; D-1\WI-1-3-4-1:0; D-1\FP-1-3-4-1:1;  
D-1\FI-1-3-4-1:1; D-1\WFM-1-3-4-1:FW;  
D-1\MNF\N-1-3-5:1; D-1\WP-1-3-5-1:33; D-1\WI-1-3-5-1:0; D-1\FP-1-3-5-1:1;  
D-1\FI-1-3-5-1:1; D-1\WFM-1-3-5-1:FW;  
D-1\MNF\N-1-3-6:1; D-1\WP-1-3-6-1:47; D-1\WI-1-3-6-1:0; D-1\FP-1-3-6-1:1;  
D-1\FI-1-3-6-1:1; D-1\WFM-1-3-6-1:FW;

*Measurement Name: J966X, lsb first, word 45, frame 3.*

**D-1\MN-1-4:J966X**; D-1\MN1-1-4:DE; D-1\MN2-1-4:D;  
D-1\MN3-1-4:L; D-1\LT-1-4:WDFR; D-1\MML\N-1-4:1; D-1\MNF\N-1-4-1:1;  
D-1\WP-1-4-1-1:45; D-1\WI-1-4-1-1:0; D-1\FP-1-4-1-1:3; D-1\FI-1-4-1-1:0;  
D-1\WFM-1-4-1-1:FW;

*(End of D-1)*

---

*(Start of D-2)*

*Live PCM signal: single measurement list, 2 measurements.*

**D-2\DLN:PCM w/async**; D-2\ML\N:1; D-2\MLN-1:JUST ONE; D-2\MN\N-1:2;

*Measurement name: E1250T, unclassified, unsigned, msb first, word 39.*

**D-2\MN-1-1:E1250T**; D-2\MN1-1-1:DE; D-2\MN2-1-1:D;  
D-2\MN3-1-1:M; D-2\LT-1-1:WDFR;  
D-2\MML\N-1-1:1; D-2\MNF\N-1-1-1:1; D-2\WP-1-1-1-1:39; D-2\WI-1-1-1-1:0;  
D-2\FP-1-1-1-1:1; D-2\FI-1-1-1-1:1; D-2\WFM-1-1-1-1:FW;

*Measurement name: W862P, unclassified, msb first, word 42, frame 8, full word.*

**D-2\MN-1-2:W862P**; D-2\MN1-1-2:DE; D-2\MN2-1-2:D; D-2\MN3-1-2:M;  
D-2\LT-1-2: WDFR; D-2\MML\N-1-2:1; D-2\MNF\N-1-2-1:1; D-2\WP-1-2-1-1:42;  
D-2\WI-1-2-1-1:0; D-2\FP-1-2-1-1:8; D-2\FI-1-2-1-1:0; D-2\WFM-1-2-1-1:FW;

*(End of D-2)*

---

(Start of D-3)

*Recorded PCM signal: single measurement list: 1 measurement.*

**D-3\DLN:PCM1;** D-3\MLN-1:ONLY ONE; D-3\MN\N-1:1;

*Measurement name: 82AJ01, fragmented, in 2 locations: words 113 and 121, frame 5 and words 113 and 121, frame 37. Word 113 contains the most significant fragment and word 121 contains the least significant fragment.*

**D-3\MN-1-1:82AJ01;** D-3\LT-1-1: WDFR; D-3\MML\N-1-1:1; D-3\MNF\N-1-1-1:2;  
D-3\WP-1-1-1-1:113; D-3\WI-1-1-1-1:0; D-3\FP-1-1-1-1:5; D-3\FI-1-1-1-1:32;  
D-3\WFM-1-1-1-1:FW;  
D-3\WP-1-1-1-2:121; D-3\WI-1-1-1-2:0; D-3\FP-1-1-1-2:5; D-3\FI-1-1-1-2:32;  
D-3\WFM-1-1-1-2:FW;

(End of D-3)

---

(Start of D-4)

*Recorded PCM signal*

**D-4\DLN:SPI;**

(End of D-4)

---

### Data Conversion Groups (C)

*C-1 and C-2 are measurements that are part of the live PCM signal (see also D-2).*

*C-3, C-4, C-5, and C-6 are from the asynchronous wave train (see also D-1).*

*C-7 is from the recorded PCM signal (see also D-3).*

*Measurement: E1250T, description: Inlet Temp Bellmouth, units: Deg C, binary format: unsigned; high value: 128, low value: -0.4, conversion type: pair sets, number of pair sets: 2, application (polynomial): Yes; order of fit: 1, telemetry value #1: 0, engineering unit value #1: -0.4, telemetry value #2: 1023, engineering unit value #2: 128.*

**C-1\DCN:E1250T;** C-1\MN1:Inlet Temp Bellmouth; C-1\MN3:DEGC;  
C-1\BFM:UNS; C-1\MOT1:128; C-1\MOT2:-0.4; C-1\DCT:PRS;  
C-1\PS\N:2; C-1\PS1:Y; C-1\PS2:1; C-1\PS3-1:0; C-1\PS4-1:-0.4;  
C-1\PS3-2:1023; C-1\PS4-2:128;

*Measurement: W862P, description: Fuel Pump Inlet, binary format: unsigned; conversion type: pair sets, number of pair sets: 2, application (polynomial): Yes; order of fit: 1, telemetry value #1: 0, engineering unit value #1: -0.1 telemetry value #2: 1023, engineering unit value #2: 76.7*

**C-2\DCN:W862P;** C-2\MN1:Fuel Pump Inlet; C-2\BFM:UNS;  
C-2\DCT:PRS; C-2\PS\N:2; C-2\PS1:Y; C-2\PS2:1; C-2\PS3-1:0;  
C-2\PS4-1:-0.1; C-2\PS3-2:1023; C-2\PS4-2:76.7;

*Measurement: J896D, description: Altitude, units: Feet, binary format: two's complement; high value: 32768, low value: -32768, conversion type: pair sets; number of pair sets: 2, application (polynomial): Yes, order of fit: 1, telemetry value #1: -32768, engineering unit value #1: -32768, telemetry value #2: 32767, engineering unit value #2: 32767*

**C-3\DCN:J896D;** C-3\MN1: Altitude; C-3\MN3:FEET;  
C-3\BFM:TWO; C-3\MOT1:32768; C-3\MOT2:-32768; C-3\DCT:PRS;  
C-3\PS\N:2; C-3\PS1:Y; C-3\PS2:1; C-3\PS3-1:-32768;  
C-3\PS4-1:-32768; C-3\PS3-2:32767; C-3\PS4-2:32767;

*Measurement: J951V, description: Throttle Command, units: VDC, high value: 10.164, low value: -10.164, conversion type: pair sets, number of pair sets: 2, application(polynomial): Yes, order of fit: 1, telemetry value #1: -128, engineering unit value #1: -10.164, telemetry value #2: 127, engineering unit value #2: 10.164, binary format: two's complement*

**C-4\DCN:J951V;** C-4\MN1:Throttle Command; C-4\MN3:VDC;  
C-4\MOT1:10.164; C-4\MOT2:-10.164; C-4\DCT:PRS; C-4\PS\N:2;  
C-4\PS1:Y; C-4\PS2:1; C-4\PS3-1:-128; C-4\PS4-1:-10.164;  
C-4\PS3-2:127; C-4\PS4-2:10.164; C-4\BFM:TWO;

*Measurement: J971U; description: DISC, conversion type: discrete, binary format: unsigned.*

**C-5\DCN:J971U;** C-5\MN1:DISC; C-5\DCT:DIS; C-5\BFM:UNS;

*Measurement: J966X; description: Discrete, conversion type: discrete, binary format: unsigned.*

**C-6\DCN:J966X;** C-6\MN1:Discrete; C-6\DCT:DIS; C-6\BFM: UNS;

*Measurement: 82AJ01, description: LANTZ Norm acceleration, units: MTR/S/S, High value: 1023.97, Low value: -1023.97, conversion type: Coefficients. Order of curve fit: 1, derived from pair sets: No, Coefficient (0): 0, Coefficient(1): 0.03125, binary format: two's complement*

**C-7\DCN:82AJ01;** C-7\MN1:LANTZ Norm acceleration; C-7\MN3:MTR/S/S;  
C-7\MOT1:1023.97; C-7\MOT2:-1023.97; C-7\DCT:COE; C-7\CO\N:1;  
C-7\CO1:N; C-7\CO:0; C-7\CO-1:.03125; C-7\BFM:TWO;

## 1.0 XML Version of Example

The entire example is presented beginning on the next page in the XML version of the TMATS. The XML elements are commented with TMATS code names to aid in associating the XML version of the example with the code name version of the example given above.

```
<?xml version="1.0" encoding="utf-8"?>
<Tmats>

    <!-- G Group -->
```

```

<ProgramName>TMATS example</ProgramName><!--PN-->
<TestItem>Wright Flyer</TestItem><!--TA-->
<OriginationDate>1903-07-12</OriginationDate><!--OD must
follow XML date format-->
<Revision>
  <Number>0</Number><!--RN-->
</Revision>
<TestNumber>13</TestNumber><!--TN-->
<PointOfContact>
  <Name>Wilbur</Name><!--POC1-->
  <Agency>Bikes, LTD</Agency><!--POC2-->
  <Address>Dayton</Address><!--POC3-->
  <Telephone>555-1212</Telephone><!--POC4-->
</PointOfContact>

  <DataSource Name="PCM w/embedded" Type="RF"><!--DSI-1:PCM
w/embedded;DST-1:RF-->

    <!-- T Group -->
    <TransmissionAttributes>
      <SourceRFAttributes>
        <Frequency>1489.5</Frequency><!--RF1-->
        <RFBandwidth>100</RFBandwidth><!--RF2-->
        <DataBandwidth>100</DataBandwidth><!--RF3-->
        <ModulationType>FM</ModulationType><!--RF4
enumeration-->

<TotalCarrierModulation>500</TotalCarrierModulation><!--RF5-->
  <!--Subcarriers not needed SCO\N:NO-->
  <TransmitAntenna>
    <Polarization>Linear</Polarization><!--
AN2:LIN-->
  </TransmitAntenna>
  <AntennaPatterns>
    <PointOfContact>
      <Name>Pat Tern</Name><!--AP\POC1-->
      <Agency>Transmissions, Inc.</Agency><!--
AP\POC2-->
      <Address>Amityville, NY</Address><!--
AP\POC3-->
      <Telephone>800-555-1212</Telephone><!--
AP\POC4-->
    </PointOfContact>
  </AntennaPatterns>
  </SourceRFAttributes>
</TransmissionAttributes>

```



```

<!-- M Group -->
<!--M1\ID:PCM w/embedded is implicit-->
<MultiplexModulationGroup>
  <CompositeSignalStructure>

<SignalStructureType>PCM</SignalStructureType><!--BB1:PCM-->
  <ModulationSense>Positive</ModulationSense><!--
BB2:POS-->
  </CompositeSignalStructure>
  <BasebandSignal>
    <SignalType>PCM</SignalType><!--BSG1:PCM-->
    <LowPassFilter>
      <Type>Constant Amplitude</Type><!--BSF2:CA--
>
      </LowPassFilter>
      <DataLinkName>PCM w/async</DataLinkName><!--
BB\DLN-->
    </BasebandSignal>
  </MultiplexModulationGroup>

  <DataLink Name="PCM w/async"><!--P-1\DLN-->

    <!-- P Group -->
    <PCMFormatAttributes>
      <InputData>
        <PCMCode>NRZ-L</PCMCode><!--D1:NRZ-L-->
        <BitRate>44000</BitRate><!--D2:44000-->
        <Encrypted>Unencrypted</Encrypted><!--D3:U--
>
        <Polarity>Normal</Polarity><!--D4:N-->
        <DataDirection>Normal</DataDirection><!--
D6:N-->
        <DataRandomized>No</DataRandomized><!--D7:N-
-->
      </InputData>
      <Format>
        <TypeFormat>Class 1</TypeFormat><!--TF:ONE--
>
        <CommonWordLength>10</CommonWordLength><!--
F1:10-->
        <WordTransferOrder>MSB
First</WordTransferOrder><!--F2:M-->
        <Parity>None</Parity><!--F3:NO-->
        <MinorFrame>

<NumberOfMinorFrames>16</NumberOfMinorFrames><!--MF\N:16-->

```

```

<WordsPerMinorFrame>43</WordsPerMinorFrame><!--MF1:43-->

<BitsPerMinorFrame>440</BitsPerMinorFrame><!--MF2:440-->
    <SyncType>Fixed Pattern</SyncType><!--
MF3:FPT-->
    <!--MF4:20 is implicit-->

<SyncPattern>01111010011010110001</SyncPattern><!--
MF5:01111010011010110001-->
    </MinorFrame>
  </Format>
  <SyncCriteria>
    <InSync>
      <Criteria>1</Criteria><!--SYNC1:1-->
      <NumberOfFSPBits>0</NumberOfFSPBits><!--
SYNC2:0-->
    </InSync>
    <OutOfSync>
      <NumberOfDisagrees>Not
Specified</NumberOfDisagrees><!--SYNC3:1-->
      <NumberOfFSPBits>0</NumberOfFSPBits><!--
SYNC4:0-->
    </OutOfSync>
  </SyncCriteria>
  <VariableWordLength>
    <Word>10</Word><!--MFW1-1-->
    <Length>8</Length><!--MFW2-1-->
  </VariableWordLength>
  <VariableWordLength>
    <Word>11</Word><!--MFW1-2-->
    <Length>12</Length><!--MFW2-2-->
  </VariableWordLength>
  <SubframeSynchronization>
    <IDCounter><!--ISF\N:1 is implicit-->
      <Name>1</Name><!--ISF1:1-->
      <SyncType>ID Counter</SyncType><!--
ISF2:ID-->
      <Location>1</Location><!--IDC1:1-->

<CounterStartingBitLocation>7</CounterStartingBitLocation><!--
IDC3:7-->
      <CounterLength>4</CounterLength><!--
IDC4:4-->
      <TransferOrder>MSB
First</TransferOrder><!--IDC5:M-->

```

```

                                <InitialValue>0</InitialValue><!--
IDC6:0-->

<InitialSubframeNumber>1</InitialSubframeNumber><!--IDC7:1-->
                                <EndValue>15</EndValue><!--IDC8:15-->

<EndSubframeNumber>16</EndSubframeNumber><!--IDC9:16-->

<CountDirection>Increasing</CountDirection><!--IDC10:INC-->
                                </IDCounter>
                                </SubframeSynchronization>
                                <AsyncEmbeddedFormat>
                                    <!--AEF\N:1 is implicit-->
                                    <DataLinkName>ASYNC</DataLinkName><!--
AEF\DLN-1:ASYNC-->
                                    <Supercom>5</Supercom><!--AEF1-1:5-->
                                    <LocationDefinition>Contiguous
Words</LocationDefinition><!--AEF2-1:CW-->
                                    <Location>6</Location><!--AEF3-1-1:6-->
                                </AsyncEmbeddedFormat>

                                <!-- D Group -->
                                <!--D-2\DLN:PCM w/async is implicit-->
                                <PCMMeasurements>
                                    <!--D-2\ML\N:1 is implicit-->
                                    <MeasurementList Name="JUST ONE"><!--MLN-
1:JUST ONE-->
                                    <!--MN\N-1:2 is implicit-->
                                    <Measurement Name="E1250T"><!--MN-1-
1:E1250T-->
                                    <Parity>Default</Parity><!--MN1-1-
1:DE-->

<ParityTransferOrder>Default</ParityTransferOrder><!--MN2-1-1:D-
->
                                <MeasurementTransferOrder>MSB
First</MeasurementTransferOrder><!--MN3-1-1:M-->
                                <LocationType>Word and
Frame</LocationType><!--LT-1-1:WDFR-->
                                <!--MML\N-1-1:1 is implicit-->
                                <MeasurementLocation>
                                    <!--MNF\N-1-1-1:1 is implicit-->
                                    <MeasurementFragments>
                                        <StartWord>39</StartWord><!--
-WP-1-1-1-1:39-->

<WordInterval>0</WordInterval><!--WI-1-1-1-1:0-->

```

```

<StartFrame>1</StartFrame><!--FP-1-1-1-1:1-->

<FrameInterval>1</FrameInterval><!--FI-1-1-1-1:1-->
    <BitMask>Full
Word</BitMask><!--WFM-1-1-1-1:FW-->
    </MeasurementFragments>
    </MeasurementLocation>
</Measurement>
<Measurement Name="W862P"><!--MN-1-
2:W862P-->
    <Parity>Default</Parity><!--MN1-1-
2:DE-->

<ParityTransferOrder>Default</ParityTransferOrder><!--MN2-1-2:D-
->
    <MeasurementTransferOrder>MSB
First</MeasurementTransferOrder><!--MN3-1-2:M-->
    <LocationType>Word and
Frame</LocationType><!--LT-1-2:WDFR-->
    <!--MML\N-1-2:1 is implicit-->
    <MeasurementLocation>
        <!--MNF\N-1-2-1:1 is implicit-->
        <MeasurementFragments>
            <StartWord>42</StartWord><!--
-WP-1-2-1-1:42-->

<WordInterval>0</WordInterval><!--WI-1-2-1-1:0-->

<StartFrame>8</StartFrame><!--FP-1-2-1-1:8-->

<FrameInterval>0</FrameInterval><!--FI-1-2-1-1:0-->
    <BitMask>Full
Word</BitMask><!--WFM-1-2-1-1:FW-->
    </MeasurementFragments>
    </MeasurementLocation>
    </Measurement>
    </MeasurementList>
    </PCMMeasurements>
    </PCMFormatAttributes>

    <!-- C Group -->
    <DataConversionAttributes>
        <Measurement Name="E1250T"><!--C-1\DCN:E1250T-->
        <Measurand>
            <Description>Inlet Temp
Bellmouth</Description><!--MN1:Inlet Temp Bellmouth-->

```

```

<EngineeringUnits>DEGC</EngineeringUnits><!--MN3:DEGC-->
    </Measurand>
    <TelemetryValueDefinition>
        <BinaryFormat>Unsigned
Binary</BinaryFormat><!--BFM:UNS-->
    </TelemetryValueDefinition>
    <OtherInformation>
        <MeasurementValue>
            <Low>-0.4</Low><!--MOT2:-0.4-->
            <High>128.0</High><!--MOT1:128-->
        </MeasurementValue>
    </OtherInformation>
    <DataConversion Type="Pair Sets"><!--
DCT:PRS-->
        <PairSets>
            <!--PS\N:2 is implicit-->
            <Application>Polynomial Curve
Fit</Application><!--PS1:Y-->
            <OrderOfFit>1</OrderOfFit><!--PS2:1-
->
            <Pair>
                <TmValue>0</TmValue><!--PS3-1:0-
->
                <EuValue>-0.4</EuValue><!--PS4-
1:-0.4-->
            </Pair>
            <Pair>
                <TmValue>1023</TmValue><!--PS3-
2:1023-->
                <EuValue>128</EuValue><!--PS4-
2:128-->
            </Pair>
        </PairSets>
    </DataConversion>
</Measurement>

    <Measurement Name="W862P"><!--C-2\DCN:W862P-->
    <Measurand>
        <Description>Fuel Pump
Inlet</Description><!--MN1:Inlet Temp Bellmouth-->
    </Measurand>
    <TelemetryValueDefinition>
        <BinaryFormat>Unsigned
Binary</BinaryFormat><!--BFM:UNS-->
    </TelemetryValueDefinition>

```

```

        <DataConversion Type="Pair Sets"><!--
DCT:PRS-->
            <PairSets>
                <!--PS\N:2 is implicit-->
                <Application>Polynomial Curve
Fit</Application><!--PS1:Y-->
                <OrderOfFit>1</OrderOfFit><!--PS2:1-
->
                <Pair>
                    <TmValue>0</TmValue><!--PS3-1:0-
->
                    <EuValue>-0.1</EuValue><!--PS4-
1:-0.1-->
                </Pair>
                <Pair>
                    <TmValue>1023</TmValue><!--PS3-
2:1023-->
                    <EuValue>76.7</EuValue><!--PS4-
2:76.7-->
                </Pair>
            </PairSets>
        </DataConversion>
    </Measurement>
</DataConversionAttributes>
</DataLink>

<DataLink Name="ASYNCR"><!--P-3\DLN:ASYNCR-->

    <!-- P Group -->
    <PCMFormatAttributes>
        <Format>
            <TypeFormat>Class 1</TypeFormat><!--TF:ONE--
>
            <CommonWordLength>16</CommonWordLength><!--
F1:16-->
            <WordTransferOrder>LSB
First</WordTransferOrder><!--F2:L-->
            <Parity>None</Parity><!--F3:NO-->
            <MinorFrame>

<NumberOfMinorFrames>3</NumberOfMinorFrames><!--MF\N:3-->

<WordsPerMinorFrame>50</WordsPerMinorFrame><!--MF1:50-->

<BitsPerMinorFrame>800</BitsPerMinorFrame><!--MF2:800-->
            <SyncType>Fixed Pattern</SyncType><!--
MF3:FPT-->

```

```

        <!--MF4:16 is implicit-->

<SyncPattern>1111100110110001</SyncPattern><!--
MF5:1111100110110001-->
        </MinorFrame>
    </Format>
    <SyncCriteria>
        <InSync>
            <Criteria>1</Criteria><!--SYNC1:1-->
        </InSync>
    </SyncCriteria>
    <SubframeSynchronization>
        <IDCounter><!--ISF\N:1 is implicit-->
            <Name>2</Name><!--ISF1-1:2-->
            <SyncType>ID Counter</SyncType><!--ISF2-
1:ID-->
                <Location>1</Location><!--IDC1-1:1-->

<CounterStartingBitLocation>15</CounterStartingBitLocation><!--
IDC3-1:15-->
                <CounterLength>2</CounterLength><!--
IDC4-1:2-->
                    <TransferOrder>LSB
First</TransferOrder><!--IDC5-1:L-->
                    <InitialValue>0</InitialValue><!--IDC6-
1:0-->

<InitialSubframeNumber>1</InitialSubframeNumber><!--IDC7-1:1-->
                <EndValue>2</EndValue><!--IDC8-1:2-->

<EndSubframeNumber>3</EndSubframeNumber><!--IDC9-1:3-->

<CountDirection>Increasing</CountDirection><!--IDC10-1:INC-->
        </IDCounter>
    </SubframeSynchronization>

    <!-- D Group -->
    <!--D-1\DLN:ASYNCR is implicit-->
    <PCMMeasurements>
        <!--D-1\ML\N:1 is implicit-->
        <MeasurementList Name="JUST ONE"><!--MLN-
1:JUST ONE-->
                <!--MN\N-1:4 is implicit-->
                <Measurement Name="J896D"><!--MN-1-
1:J896D-->
                    <MeasurementTransferOrder>LSB
First</MeasurementTransferOrder><!--MN3-1-1:L-->

```

```

                <LocationType>Word and
Frame</LocationType><!--LT-1-1:WDFR-->
                <!--MML\N-1-1:2 is implicit-->
                <MeasurementLocation>
                    <!--MNF\N-1-1-1:1 is implicit-->
                    <MeasurementFragments>
                        <StartWord>14</StartWord><!--
-WP-1-1-1-1:14-->

<WordInterval>0</WordInterval><!--WI-1-1-1-1:0-->

<StartFrame>1</StartFrame><!--FP-1-1-1-1:1-->

<FrameInterval>0</FrameInterval><!--FI-1-1-1-1:0-->
                    <BitMask>Full
Word</BitMask><!--WFM-1-1-1-1:FW-->
                </MeasurementFragments>
                </MeasurementLocation>
                <MeasurementLocation>
                    <!--MNF\N-1-1-2:1 is implicit-->
                    <MeasurementFragments>
                        <StartWord>39</StartWord><!--
-WP-1-1-1-1:39-->

<WordInterval>0</WordInterval><!--WI-1-1-1-1:0-->

<StartFrame>2</StartFrame><!--FP-1-1-1-1:2-->

<FrameInterval>0</FrameInterval><!--FI-1-1-1-1:0-->
                    <BitMask>Full
Word</BitMask><!--WFM-1-1-2-1:FW-->
                </MeasurementFragments>
                </MeasurementLocation>
                </Measurement>
                <Measurement Name="J951V"><!--MN-1-
2:J951V-->
                    <Parity>Default</Parity><!--MN1-1-
2:DE-->

<ParityTransferOrder>Default</ParityTransferOrder><!--MN2-1-2:D-
->
                    <MeasurementTransferOrder>LSB
First</MeasurementTransferOrder><!--MN3-1-2:L-->
                <LocationType>Word and
Frame</LocationType><!--LT-1-2:WDFR-->
                <!--MML\N-1-2:1 is implicit-->
                <MeasurementLocation>

```



```

                                <!--MNF\N-1-2-1:1 is implicit-->
                                <MeasurementFragments>
                                <StartWord>3</StartWord><!--
WP-1-2-1-1:3-->

<WordInterval>0</WordInterval><!--WI-1-2-1-1:0-->

<StartFrame>1</StartFrame><!--FP-1-2-1-1:1-->

<FrameInterval>0</FrameInterval><!--FI-1-2-1-1:0-->

<BitMask>1111111100000000</BitMask><!--WFM-1-2-1-
1:1111111100000000-->
                                </MeasurementFragments>
                                </MeasurementLocation>
                                </Measurement>
                                <Measurement Name="J971U"><!--MN-1-
3:J971U-->
                                <Parity>Default</Parity><!--MN1-1-
3:DE-->

<ParityTransferOrder>Default</ParityTransferOrder><!--MN2-1-3:D-
->
                                <MeasurementTransferOrder>LSB
First</MeasurementTransferOrder><!--MN3-1-3:L-->
                                <LocationType>Word and
Frame</LocationType><!--LT-1-3:WDFR-->
                                <!--MML\N-1-3:6 is implicit-->
                                <MeasurementLocation>
                                <!--MNF\N-1-3-1:1 is implicit-->
                                <MeasurementFragments>
                                <StartWord>2</StartWord><!--
WP-1-3-1-1:2-->

<WordInterval>0</WordInterval><!--WI-1-3-1-1:0-->

<StartFrame>1</StartFrame><!--FP-1-3-1-1:1-->

<FrameInterval>1</FrameInterval><!--FI-1-3-1-1:1-->
                                <BitMask>Full
Word</BitMask><!--WFM-1-3-1-1:FW-->
                                </MeasurementFragments>
                                </MeasurementLocation>
                                <MeasurementLocation>
                                <!--MNF\N-1-3-2:1 is implicit-->
                                <MeasurementFragments>

```

```

                                <StartWord>11</StartWord><!--
-WP-1-3-2-1:11-->

<WordInterval>0</WordInterval><!--WI-1-3-2-1:0-->

<StartFrame>1</StartFrame><!--FP-1-3-2-1:1-->

<FrameInterval>1</FrameInterval><!--FI-1-3-2-1:1-->
                                <BitMask>Full
Word</BitMask><!--WFM-1-3-2-1:FW-->
                                </MeasurementFragments>
                                </MeasurementLocation>
                                <MeasurementLocation>
                                <!--MNF\N-1-3-3:1 is implicit-->
                                <MeasurementFragments>
                                <StartWord>20</StartWord><!--
-WP-1-3-3-1:20-->

<WordInterval>0</WordInterval><!--WI-1-3-3-1:0-->

<StartFrame>1</StartFrame><!--FP-1-3-3-1:1-->

<FrameInterval>1</FrameInterval><!--FI-1-3-3-1:1-->
                                <BitMask>Full
Word</BitMask><!--WFM-1-3-3-1:FW-->
                                </MeasurementFragments>
                                </MeasurementLocation>
                                <MeasurementLocation>
                                <!--MNF\N-1-3-4:1 is implicit-->
                                <MeasurementFragments>
                                <StartWord>29</StartWord><!--
-WP-1-3-4-1:29-->

<WordInterval>0</WordInterval><!--WI-1-3-4-1:0-->

<StartFrame>1</StartFrame><!--FP-1-3-4-1:1-->

<FrameInterval>1</FrameInterval><!--FI-1-3-4-1:1-->
                                <BitMask>Full
Word</BitMask><!--WFM-1-3-4-1:FW-->
                                </MeasurementFragments>
                                </MeasurementLocation>
                                <MeasurementLocation>
                                <!--MNF\N-1-3-5:1 is implicit-->
                                <MeasurementFragments>
                                <StartWord>33</StartWord><!--
-WP-1-3-5-1:33-->

```

```

<WordInterval>0</WordInterval><!--WI-1-3-5-1:0-->

<StartFrame>1</StartFrame><!--FP-1-3-5-1:1-->

<FrameInterval>1</FrameInterval><!--FI-1-3-5-1:1-->
    <BitMask>Full
Word</BitMask><!--WFM-1-3-5-1:FW-->
    </MeasurementFragments>
    </MeasurementLocation>
    <MeasurementLocation>
        <!--MNF\N-1-3-6:1 is implicit-->
        <MeasurementFragments>
            <StartWord>47</StartWord><!--
-WP-1-3-6-1:47-->

<WordInterval>0</WordInterval><!--WI-1-3-6-1:0-->

<StartFrame>1</StartFrame><!--FP-1-3-6-1:1-->

<FrameInterval>1</FrameInterval><!--FI-1-3-6-1:1-->
    <BitMask>Full
Word</BitMask><!--WFM-1-3-6-1:FW-->
    </MeasurementFragments>
    </MeasurementLocation>
    </Measurement>
    <Measurement Name="J966X"><!--MN-1-
4:J966X-->
    <Parity>Default</Parity><!--MN1-1-
4:DE-->

<ParityTransferOrder>Default</ParityTransferOrder><!--MN2-1-4:D-
->
    <MeasurementTransferOrder>LSB
First</MeasurementTransferOrder><!--MN3-1-4:L-->
    <LocationType>Word and
Frame</LocationType><!--LT-1-4:WDFR-->
    <!--MML\N-1-4:1 is implicit-->
    <MeasurementLocation>
        <!--MNF\N-1-4-1:1 is implicit-->
        <MeasurementFragments>
            <StartWord>45</StartWord><!--
-WP-1-4-1-1:45-->

<WordInterval>0</WordInterval><!--WI-1-4-1-1:0-->

<StartFrame>3</StartFrame><!--FP-1-4-1-1:3-->

```

```

<FrameInterval>0</FrameInterval><!--FI-1-4-1-1:0-->
    <BitMask>Full
Word</BitMask><!--WFM-1-4-1-1:FW-->
    </MeasurementFragments>
    </MeasurementLocation>
    </Measurement>
    </MeasurementList>
    </PCMMeasurements>
</PCMFormatAttributes>

<!-- C Group -->
<DataConversionAttributes>
    <Measurement Name="J896D"><!--C-3\DCN:J896D-->
        <Measurand>
            <Description>Terrain
Altitude</Description><!--MN1:Terrain Altitude-->

<EngineeringUnits>FEET</EngineeringUnits><!--MN3:FEET-->
    </Measurand>
    <TelemetryValueDefinition>
        <BinaryFormat>Two's
Complement</BinaryFormat><!--BFM:TWO-->
    </TelemetryValueDefinition>
    <OtherInformation>
        <MeasurementValue>
            <Low>-32768.0</Low><!--MOT2:-32768--
>
            <High>32768.0</High><!--MOT1:32768--
>
        </MeasurementValue>
    </OtherInformation>
    <DataConversion Type="Pair Sets"><!--
DCT:PRS-->
        <PairSets>
            <!--PS\N:2 is implicit-->
            <Application>Polynomial Curve
Fit</Application><!--PS1:Y-->
            <OrderOfFit>1</OrderOfFit><!--PS2:1-
->
            <Pair>
                <TmValue>-32768</TmValue><!--
PS3-1:-32768-->
                <EuValue>-32768.0</EuValue><!--
PS4-1:-32768-->
            </Pair>
            <Pair>

```

```

                <TmValue>32767</TmValue><!--PS3-
2:32767-->
                <EuValue>32767.0</EuValue><!--
PS4-2:32767-->
                </Pair>
                </PairSets>
                </DataConversion>
</Measurement>

    <Measurement Name="J951V"><!--C-4\DCN:J951V-->
        <Measurand>
            <Description>Throttle
Command</Description><!--MN1:Throttle Command-->
<EngineeringUnits>VDC</EngineeringUnits><!--MN3:VDC-->
            </Measurand>
            <TelemetryValueDefinition>
                <BinaryFormat>Two's
Complement</BinaryFormat><!--BFM:TWO-->
            </TelemetryValueDefinition>
            <OtherInformation>
                <MeasurementValue>
                    <Low>-10.164</Low><!--MOT2:-10.164--
>
                    <High>10.164</High><!--MOT1:10.164--
>
                </MeasurementValue>
            </OtherInformation>
            <DataConversion Type="Pair Sets"><!--
DCT:PRS-->
                <PairSets>
                    <!--PS\N:2 is implicit-->
                    <Application>Polynomial Curve
Fit</Application><!--PS1:Y-->
                    <OrderOfFit>1</OrderOfFit><!--PS2:1-
->
                    <Pair>
                        <TmValue>-128</TmValue><!--PS3-
1:-128-->
                        <EuValue>-10.164</EuValue><!--
PS4-1:-10.164-->
                    </Pair>
                    <Pair>
                        <TmValue>127</TmValue><!--PS3-
2:127-->
                        <EuValue>10.164</EuValue><!--
PS4-2:10.164-->

```

```

        </Pair>
    </PairSets>
</DataConversion>
</Measurement>

    <Measurement Name="J971U"><!--C-5\DCN:J971U-->
        <Measurand>
            <Description>DISC</Description><!--
MN1:DISC-->
                </Measurand>
                <TelemetryValueDefinition>
                    <BinaryFormat>Unsigned
Binary</BinaryFormat><!--BFM:UNS-->
                </TelemetryValueDefinition>
                <DataConversion Type="Discrete"><!--DCT:DIS-
->
                    <!--what else goes here?-->
                </DataConversion>
            </Measurement>

    <Measurement Name="J966X"><!--C-6\DCN:J966X-->
        <Measurand>
            <Description>Discrete</Description><!--
MN1:Discrete-->
                </Measurand>
                <TelemetryValueDefinition>
                    <BinaryFormat>Unsigned
Binary</BinaryFormat><!--BFM:UNS-->
                </TelemetryValueDefinition>
                <DataConversion Type="Discrete"><!--DCT:DIS-
->
                    <!--what else goes here?-->
                </DataConversion>
            </Measurement>

    </DataConversionAttributes>
</DataLink>

</DataSource>

<PointOfContact>
    <Name>Orville</Name><!--POC1-2: Orville-->
    <Agency>Bikes, LTD</Agency><!--POC2-2: Bikes, LTD-->
    <Address>Dayton</Address><!--POC3-2: Dayton-->
    <Telephone>555-1212</Telephone><!--POC4-2: 555-1212-->
</PointOfContact>

```

```

<DataSource Name="Two PCM links - TM & TSPI"
Type="Storage"><!--DSI-2:Two PCM links - TM & TSPI;DST-2:STO-->

    <!-- R Group -->
    <RecorderReproducerAttributes>
        <ID>Two PCM links - TM & TSPI</ID><!--R-1\ID:Two
PCM links - TM & TSPI-->
        <Description>Recorded Data</Description><!--
R1:Recorded Data-->
        <Characteristics>
            <Type>Magnetic Disk</Type><!--TC1:MD-->

<NumberOfTracksOrChannels>2</NumberOfTracksOrChannels><!--N:2-->
    </Characteristics>
    <RecorderReproducerInfo>
        <Manufacturer>ZZ</Manufacturer><!--RI1:ZZ-->
        <Model>13</Model><!--RI2:13-->
        <OriginalRecording>Yes</OriginalRecording><!--
RI3:Y-->
        <OriginalRecordingDateAndTime>2011-07-
12T07:55:59</OriginalRecordingDateAndTime><!--RI4:07-12-2011-07-
55-59-->
        <CreatingOrganizationPointOfContact>
            <Name>Mr. Tenn</Name><!--POC1:Mr. Tenn-->
            <Agency>Data Creations</Agency><!--POC2:Data
Creations-->
            <Address>Anywhere, Ttown</Address><!--
POC3:Anywhere, Ttown-->
            <Telephone>555-1212</Telephone><!--POC4:555-
1212-->
        </CreatingOrganizationPointOfContact>
    </RecorderReproducerInfo>
    <Data>

<TrackNumberOrChannelID>2</TrackNumberOrChannelID><!--TK1-1:2-->
    <DataSourceID>PCM w/subframe
fragmented</DataSourceID><!--DSI-1:PCM w/subframe fragmented-->
    <ChannelDataType>PCM Input</ChannelDataType><!--
CDT-1:PCMIN-->

<ChannelDataLinkName>PCM1</ChannelDataLinkName><!--CDLN-1:PCM1--
>

<TrackNumberOrChannelID>4</TrackNumberOrChannelID><!--TK1-2:4-->
    <DataSourceID>Space Position
Information</DataSourceID><!--DSI-2:Space Position Information--
>

```

```

        <ChannelDataType>PCM Input</ChannelDataType><!--
CDT-2:PCMIN-->
<ChannelDataLinkName>SPI</ChannelDataLinkName><!--CDLN-2:SPI-->
    </Data>
    </RecorderReproducerAttributes>

</DataSource>

    <DataLink Name="PCM1"><!--P-2\DLN:PCM1-->

    <!-- P Group -->
    <PCMFormatAttributes>
        <InputData>
            <PCMCode>NRZ-L</PCMCode><!--D1:NRZ-L-->
            <BitRate>2000000</BitRate><!--D2:2000000-->
            <Encrypted>Unencrypted</Encrypted><!--D3:U--
>
            <Polarity>Normal</Polarity><!--D4:N-->
        </InputData>
        <Format>
            <TypeFormat>Class 1</TypeFormat><!--TF:ONE--
>
            <CommonWordLength>10</CommonWordLength><!--
F1:10-->
            <WordTransferOrder>MSB
First</WordTransferOrder><!--F2:M-->
            <Parity>None</Parity><!--F3:NO-->
            <MinorFrame>

<NumberOfMinorFrames>64</NumberOfMinorFrames><!--MF\N:64-->

<WordsPerMinorFrame>277</WordsPerMinorFrame><!--MF1:277-->
    <!--MF4:30 is implicit-->

<SyncPattern>101110000001100111110101101011</SyncPattern><!--
MF5:101110000001100111110101101011-->
    </MinorFrame>
    </Format>
    <SyncCriteria>
        <InSync>
            <Criteria>1</Criteria><!--SYNC1:1-->
        </InSync>
    </SyncCriteria>
    <VariableWordLength>
        <Word>121</Word><!--MFW1-1:121-->
        <Length>6</Length><!--MFW2-1:6-->

```



```

</VariableWordLength>
<VariableWordLength>
  <Word>122</Word><!--MFW1-2:122-->
  <Length>4</Length><!--MFW2-2:4-->
</VariableWordLength>
<SubframeSynchronization>
  <IDCounter><!--ISF\N:1 is implicit-->
    <Name>1</Name><!--ISF1-1:1-->
    <SyncType>ID Counter</SyncType><!--ISF2-
1:ID-->
    <Location>13</Location><!--IDC1-1:13-->

<CounterStartingBitLocation>5</CounterStartingBitLocation><!--
IDC3-1:5-->
    <CounterLength>6</CounterLength><!--
IDC4-1:6-->
    <TransferOrder>MSB
First</TransferOrder><!--IDC5-1:M-->
    <InitialValue>0</InitialValue><!--IDC6-
1:0-->

<InitialSubframeNumber>1</InitialSubframeNumber><!--IDC7-1:1-->
    <EndValue>63</EndValue><!--IDC8-1:63-->

<EndSubframeNumber>64</EndSubframeNumber><!--IDC9-1:64-->

<CountDirection>Increasing</CountDirection><!--IDC10-1:INC-->
  </IDCounter>
</SubframeSynchronization>

<!-- D Group -->
<PCMMeasurements>
<!--D-3\DLN:PCM1 is implicit-->
  <MeasurementList Name="ONLY ONE"><!--MLN-
1:ONLY ONE-->
    <!--MN\N-1:1 is implicit-->
    <Measurement Name="82AJ01"><!--MN-1-
1:82AJ01-->
      <LocationType>Word and
Frame</LocationType><!--LT-1-1:WDFR-->
      <MeasurementLocation>
        <MeasurementFragments>

<StartWord>113</StartWord><!--WP-1-1-1-1:113-->

<WordInterval>0</WordInterval><!--WI-1-1-1-1:0-->

```

```

<StartFrame>5</StartFrame><!--FP-1-1-1-1:5-->

<FrameInterval>32</FrameInterval><!--FI-1-1-1-1:32-->
    <BitMask>Full
Word</BitMask><!--WFM-1-1-1-1:FW-->
    </MeasurementFragments>
    </MeasurementLocation>
    <MeasurementLocation>
    <MeasurementFragments>

<StartWord>121</StartWord><!--WP-1-1-1-2:121-->

<WordInterval>0</WordInterval><!--WI-1-1-1-2:0-->

<StartFrame>5</StartFrame><!--FP-1-1-1-2:5-->

<FrameInterval>32</FrameInterval><!--FI-1-1-1-2:32-->
    <BitMask>FW</BitMask><!--
WFM-1-1-1-2:FW-->
    </MeasurementFragments>
    </MeasurementLocation>
    </Measurement>
    </MeasurementList>
    </PCMMeasurements>
    </PCMFormatAttributes>

    <!-- C Group -->
    <DataConversionAttributes>
        <Measurement Name="82AJ01"><!--C-7\DCN:82AJ01-->
        <Measurand>
            <Description>LANTZ Norm
acceleration</Description><!--MN1:LANTZ Norm acceleration-->

<EngineeringUnits>MTR/S/S</EngineeringUnits><!--MN3:MTR/S/S-->
    </Measurand>
    <TelemetryValueDefinition>
        <BinaryFormat>Two's
Complement</BinaryFormat><!--BFM:TWO-->
    </TelemetryValueDefinition>
    <OtherInformation>
        <MeasurementValue>
            <Low>-1023.97</Low><!--MOT2:-
1023.97-->
            <High>1023.97</High><!--
MOT1:1023.97-->
        </MeasurementValue>

```

```

        </OtherInformation>
        <DataConversion Type="Coefficients"><!--
DCT:COE-->
            <Coefficients>
                <!--CO\N:1 is implicit-->

<DerivedFromPairSet>No</DerivedFromPairSet><!--CO1:N-->
                <Coefficient
N="0">0</Coefficient><!--CO:0-->
                <Coefficient
N="1">0.03125</Coefficient><!--CO-1:.03125-->
                </Coefficients>
            </DataConversion>
        </Measurement>
    </DataConversionAttributes>
</DataLink>

    <DataLink Name="SPI"><!--P-4\DLN:SPI-->
<!-- P Group -->
    <PCMFormatAttributes>
        <!-- D Group -->
        <PCMMeasurements>
            <!--D-4\DLN:SPI is implicit-->
            </PCMMeasurements>
        </PCMFormatAttributes>
    </DataLink>

    <Comment>I hope this flies.</Comment><!--COM: I hope this
flies.-->

</Tmats>
<!-- Last revised on: v3 2012/02/21 -->

```

This page intentionally left blank.

## APPENDIX 9-D

### Floating Point Formats

#### D.1. Introduction

[Table D-1](#) provides a summary of floating point formats. Details of each format are shown on the pages following the table.

Table D-1. Floating Point Formats							
Type	Size	Radix	Sign	Exponent	Fraction	Bias	Formula
IEEE_32	32	2	1	8	23	127	$(-1^S)(1.F)(2^{(E-127)})$
IEEE_64	64	2	1	11	52	1023	$(-1^S)(1.F)(2^{(E-1023)})$
1750A_32	32	2	0	8	24	0	$(0.F)(2^E)$
1750A_48	48	2	0	8	40	0	$(0.F)(2^E)$
DEC_32	32	2	1	8	23	128	$(-1^S)(0.1F)(2^{(E-128)})$
DEC_64	64	2	1	8	55	128	$(-1^S)(0.1F)(2^{(E-128)})$
DEC_64G	64	2	1	11	52	1024	$(-1^S)(0.1F)(2^{(E-1024)})$
IBM_32	32	16	1	7	24	64	$(-1^S)(0.F)(16^{(E-64)})$
IBM_64	64	16	1	7	56	64	$(-1^S)(0.F)(16^{(E-64)})$
TI_32	32	2	1	8	24	0	$((-2)^S + (0.F))(2^E)$
TI_40	40	2	1	8	32	0	$((-2)^S + (0.F))(2^E)$

#### D.2. IEEE 754 32-Bit Single Precision Floating Point

S	Exponent		Fraction	
1	2	9	10	32
			$2^{-1}$	$2^{-23}$

$$\text{Value} = (-1^S)(1.F)(2^{(E-127)})$$

where S = sign: 0 = Positive, 1 = Negative

Exponent = power of 2 with bias of 127

Fraction = F portion of 23-bit fraction 1.F

0: E = 0, F = 0

#### D.3. IEEE 754 64-Bit Double Precision Floating Point

S	Exponent		Fraction	
1	2	12	13	64
			$2^{-1}$	$2^{-52}$

$$\text{Value} = (-1^S)(1.F)(2^{(E-1023)})$$

where S = sign: 0 = Positive, 1 = Negative

Exponent = power of 2 with bias of 1023

Fraction = F portion of 52-bit fraction 1.F

0: E = 0, F = 0

**D.4. MIL-STD-1750A 32-Bit Single Precision Floating Point**

S	Fraction		Exponent	
1	2	24	25	32
	$2^{-1}$	$2^{-23}$		

Value = (0.F)(2<sup>E</sup>)

where Exponent = 2's complement power of 2

S = sign: 0 = Positive, 1 = Negative

S + Fraction = Normalized, 2's complement F portion of 24-bit fraction 0.F (Bit 2 MUST be set for positive, clear for negative)

0: F = 0

**D.5. MIL-STD-1750A 48-Bit Double Precision Floating Point**

S	Fraction (MSW)		Exponent		Fraction (LSW)	
1	2	24	25	32	33	48
	$2^{-1}$	$2^{-23}$			$2^{-24}$	$2^{-31}$

Value = (0.F)(2<sup>E</sup>)

where Exponent = 2's complement power of 2

S = sign: 0 = Positive, 1 = Negative

S + Fraction = Normalized, 2's complement F portion of 40-bit fraction 0.F (Bit 2 MUST be set for positive, clear for negative)

0: F = 0

**D.6. DEC 32-Bit Single Precision Floating Point**

S	Exponent		Fraction	
1	2	9	10	32
			$2^{-2}$	$2^{-24}$

Value = (-1<sup>S</sup>)(0.1F)(2<sup>(E-128)</sup>)

where S = sign: 0 = Positive, 1 = Negative

Exponent = power of 2 with bias of 128

Fraction = F portion of 23-bit fraction 0.1F

0: S = 0 & F = 0 & E = 0

**D.7. DEC 64-Bit Double Precision Floating Point**

S	Exponent		Fraction	
1	2	9	10	64
			$2^{-2}$	$2^{-56}$

Value = (-1<sup>S</sup>)(0.1F)(2<sup>(E-128)</sup>)

where S = sign: 0 = Positive, 1 = Negative  
 Exponent = power of 2 with bias of 128  
 Fraction = F portion of 55-bit fraction 0.1F  
 0: S = 0 & F = 0 & E = 0

**D.8. DEC 64-Bit “G” Double Precision Floating Point**

S	Exponent		Fraction	
1	2	12	13	64
			$2^{-2}$	$2^{-53}$

Value =  $(-1^S)(0.1F)(2^{(E-1024)})$

where S = sign: 0 = Positive, 1 = Negative  
 Exponent = power of 2 with bias of 1024  
 Fraction = F portion of 52-bit fraction 0.1F  
 0: S = 0 & F = 0 & E = 0

**D.9. IBM 32-Bit Single Precision Floating Point**

S	Exponent		Fraction	
1	2	8	9	32
			$2^{-1}$	$2^{-24}$

Value =  $(-1^S)(0.F)(16^{(E-64)})$

where S = sign: 0 = Positive, 1 = Negative  
 Exponent = power of 16 with bias of 64  
 Fraction = Normalized F portion of 24-bit fraction 0.F (Bits 9-12 cannot be all zero)  
 0: F = 0

**D.10. IBM 64-Bit Double Precision Floating Point**

S	Exponent		Fraction	
1	2	8	9	64
			$2^{-1}$	$2^{-56}$

Value =  $(-1^S)(0.F)(16^{(E-64)})$

where S = sign: 0 = Positive, 1 = Negative  
 Exponent = power of 16 with bias of 64  
 Fraction = Normalized F portion of 56-bit fraction 0.F (Bits 9-12 cannot be all zero)  
 0: F = 0

**D.11. TI (Texas Instruments) 32-Bit Single Precision Floating Point**

Exponent	S	Fraction	
1	8	9	32
		$2^{-1}$	$2^{-23}$

$$\text{Value} = ((-2)^S + (0.F))(2^E)$$

where Exponent = 2's complement power of 2

S = sign: 0 = Positive, 1 = Negative

Fraction = 2's complement F portion of 24-bit fraction 1.F

0: E = -128

**D.12. TI (Texas Instruments) 40-Bit Extended Precision Floating Point**

Exponent	S	Fraction	
1	8	9	10
			40
		$2^{-1}$	$2^{-31}$

$$\text{Value} = ((-2)^S + (0.F))(2^E)$$

where Exponent = 2's complement power of 2

S = sign: 0 = Positive, 1 = Negative

Fraction = 2's complement F portion of 32-bit fraction 1.F

0: E = -128



## APPENDIX 9-E

### Derived Parameter Specification

#### E.1. Derived Parameter Definition

Derived parameters are measurements that do not appear in any data stream; instead, they are calculated from telemetry measurements in a data stream, numeric constants, and/or other derived measurements. In a Telemetry Attributes Transfer Standard (TMATS) file, derived measurements will only have entries in the C group; the other TMATS groups containing measurement names that link to C group entries only include telemetry measurements.

Derived parameters are defined using the Algorithm Type (C-d\DPAT) and Algorithm (C-d\DPA) attributes in the Derived Parameter section of the TMATS C group. They can be defined in one of two methods. The first method is to specify the name of an algorithm (“function style”) and the second method is to specify a text string of the algorithm itself (“formula style”). Both of these methods are currently used in telemetry processing systems.

In function style, Algorithm Type is set to “N” and Algorithm contains the name of a function, which will be one of the mathematical functions or operators as defined in the derived algorithm grammar shown in this appendix. The Input Measurand attributes (C-d\DP\N and C-d\DP-n) and Input Constant attributes (C-d\DPC\N and C-d\DPC-n) are used to specify the arguments needed by the named function (measurements and numeric constants, respectively, as defined in the derived algorithm grammar in this appendix). The Trigger Measurand and Number of Occurrences attributes are used to specify when and how often the derived parameter will be calculated.

In formula style, Algorithm Type is set to “A” and Algorithm contains the actual function, given according to the derived algorithm grammar defined in this appendix. The Input Measurand attributes and Input Constant attributes are not used. The Trigger Measurand and Number of Occurrences attributes are used to specify when and how often the derived parameter will be calculated.

#### E.2. Derived Algorithm Grammar: Components

Derived algorithm grammar is from the four components listed below. The derived algorithm may be any combination of operators, functions, measurements, and numeric constants strung together using the guidelines in this document to create complex mathematical expressions (see Subsection [E.6.b](#)). Sample syntaxes for the Yet Another Compiler Compiler (Yacc) grammar and Lexicon (Lex) grammar are provided in Section [E.8](#).

- a. Operators (Section [E.3](#))
- b. Numeric Constants (Section [E.4](#))
- c. Measurements (Section [E.5](#))
- d. Mathematical Functions (Section [E.6](#)).

#### E.3. Operators

Operators are simply mathematical functions that have a special syntax in the grammar. They have operator symbol(s) that have well-defined arguments and return a value as a result.

Logical operators are merely functions that return a value of 0 and non-zero for false and true respectively.

E.3.a. Arithmetic Operators

<b>Table E-1. Arithmetic Operators</b>		
<b>Operator</b>	<b>Description</b>	<b>Example</b>
+	Addition (Sum)	$A + B$
-	Subtraction (Difference)	$A - B$
*	Multiplication (Product)	$A * B$
/	Division (Quotient)	$A / B$
%	Modulus (Remainder)	$A \% B$
**	Exponentiation	$A ** B$

E.3.b. Bit Manipulation Operators

<b>Table E-2. Bit Manipulation Operators</b>		
<b>Operator</b>	<b>Description</b>	<b>Example</b>
	Bit-wise OR	$A   B$
&	Bit-wise AND	$A \& B$
^	Bit-wise XOR	$A \wedge B$
~	Bit-wise NOT	$\sim A$
<<	Bit-wise Left Shift	$A \ll B$
>>	Bit-wise Right Shift	$A \gg B$

E.3.c. Relational Operators

<b>Table E-3. Relational Operators</b>		
<b>Operator</b>	<b>Description</b>	<b>Example</b>
==	Equal To	$A == B$
!=	Not Equal To	$A != B$
<=	Less Than or Equal To	$A \leq B$
>=	Greater Than or Equal To	$A \geq B$
<	Less Than	$A < B$
>	Greater Than	$A > B$
	Logical OR	$A    B$
&&	Logical AND	$A \&\& B$
!	Logical NOT (Negation)	$!A$

E.3.d. Ternary (if then else) Operator

<b>Table E-4. Ternary (if then else) Operator</b>		
<b>Operator</b>	<b>Description</b>	<b>Example</b>
?:	Ternary Operator (if-then-else)	A ? B : C

E.3.e. Associativity Operator

<b>Table E-5. Associativity Operator</b>		
<b>Operator</b>	<b>Description</b>	<b>Example</b>
()	Associativity	(A + B) * C

E.3.f. Precedence and Associativity of Operators From Highest to Lowest

<b>Table E-6. Precedence and Associativity of Operators from Highest to Lowest</b>	
<b>Operators</b>	<b>Associativity</b>
()	Left to right
-(UNARY)	Right to left
! ~	Right to left
**	Left to right
&	Left to right
^	Left to right
	Left to right
* / %	Left to right
+ -	Left to right
<< >>	Left to right
< > <= >=	Left to right
= = !=	Left to right
&&	Left to right
	Left to right
?:	Right to left
,	Left to right

E.4. **Numeric Constants**

Numeric constants are simply numbers used in the calculations.

<b>Table E-7 Numeric Constants (Examples)</b>	
<b>Description</b>	<b>Examples</b>
Any string of characters that contains only numerals	1234 0
Any string of characters that contains only numerals and a-f preceded by "0x" (hex)	0x12ab 0x1

Any string of characters that contains only numerals and a single ".".	1.2 1. .2
Any string of characters that contains only numerals, in scientific notation.	1.0E+10 10E-10 .1e6
Note: As in the TMATS standard itself, alphanumeric data items are case insensitive; either upper or lower case characters are allowed.	

**E.5. Measurements**

Measurements may be telemetry measurements or other derived measurements.

<b>Table E-8. Measurements (Examples)</b>	
<b>Description</b>	<b>Examples</b>
Any string of characters beginning with an alphabetic character and containing only alphanumerics and "\$_"	A00.1 A\$1
Any string of characters that is quoted with " and does not contain "	"0001" "measurement 'quoted', though this is insane - it is legal"
Any string of characters quoted with ' and does not contain '	'Air Speed'
Any string of characters that contains only numerals and at least one alphabetic character. This differs from hex because it does not begin with "0x".	00A1 0X (this is ok, because it does not have a number after "0X")
Note: As in the TMATS standard itself, alphanumeric data items are case insensitive; either upper or lower case characters are allowed.	

**E.6. Mathematical Functions**

**E.6.a. Mathematical Function Format**

Mathematical functions are numerical functions that take some input, perform a specific calculation, and return a value as the result. Each mathematical function has the form "name(arg1,arg2,...)" that identifies a well-defined name and contains argument(s) that are separated by commas and surrounded by parentheses. A list of selected mathematical functions is provided in [Table E-9](#).

**E.6.b. Complex Use of Functions**

Examples of how functions can be used in mathematical expressions are:

- e.  $A*(\text{SIN}(B/C)+D)$
- f.  $A*3.0$
- g.  $"0001"*A+\sim B$
- h.  $A<B \parallel B<<C ? D : E$

<b>Table E-9. Table of Selected Mathematical Functions</b>	
<b>Name</b>	<b>Description</b>
acos(x)	$\cos^{-1}(x)$ in range $[0, \pi]$ , $x \in [-1, 1]$ .
asin(x)	$\sin^{-1}(x)$ in range $[-\pi/2, \pi/2]$ , $x \in [-1, 1]$ .
atan(x)	$\tan^{-1}(x)$ in range $[-\pi/2, \pi/2]$
atan2(y,x)	$\tan^{-1}(y/x)$ in range $[-\pi, \pi]$
ceil(x)	smallest integer not less than x
cos(x)	cosine of x
cosh(x)	hyperbolic cosine of x
exp(x)	exponential function, computes $e^x$
fabs(x)	absolute value $ x $
floor(x)	largest integer not greater than x
fmod(x)	floating point remainder
frexp(d)	Find x in $[\.5, 1]$ and y so that $d = x * \text{pow}(2, y)$ , return x
frexp(d)	Find x in $[\.5, 1]$ and y so that $d = x * \text{pow}(2, y)$ , return y
ldexp(d,i)	returns $d * \text{pow}(2, i)$
log(x)	natural logarithm $\ln(x)$ , $x > 0$
log10(x)	base-10 logarithm $\log_{10}(x)$ , $x > 0$
max(x,y)	if $x > y$ , then return x, else return y
min(x,y)	if $x < y$ , then return x, else return y
modfd(d)	returns integral part of d
modfp(d)	returns fractional part of d
pow(x,y)	compute a value taken to an exponent, $x^y$ . An error occurs when $x \leq 0$ and $y \leq 0$ or $x < 0$ and y is not an integer
sin(x)	sine of x
sinh(x)	hyperbolic sine of x
sqrt(x)	square root $\sqrt{x}$ , $x \geq 0$
tan(x)	tangent of x
tanh(x)	hyperbolic tangent of x

### E.7. Derived Grammar Syntax Overview

The following grammar, strictly speaking, does not match the C language. Although loosely based on C, the grammar attempts to follow the “spirit” of the C language. The grammar contains three terminal symbols (MEASUREMENT, NUMERIC\_CONSTANT, and FUNCTION\_NAME) not defined here, but easily understood by their names. The grammar contains two non-terminals, expression and expression-list, which define the entire grammar. The “|” operator used in the grammar denotes a choice meaning “this or that or ...”. Quoted strings are literal tokens of the grammar.

```

expression:
  expression '+' expression
  | expression '-' expression
  | expression '*' expression
  | expression '/' expression
  | expression '|' expression
  | expression '&' expression
  | expression '%' expression
  | expression '**' expression
  | expression '?' expression ':' expression
  | expression '<' expression
  | expression '>' expression
  | expression '<=' expression
  | expression '>=' expression
  | expression '!=' expression
  | expression '==' expression
  | expression '&&' expression
  | expression '||' expression
  | '-' expression
  | '!' expression
  | '~' expression
  | '(' expression ')'
  | MEASUREMENT
  | NUMERIC_CONSTANT
  | FUNCTION_NAME '(' expression_list ')'
  | FUNCTION_NAME '(' ')'

expression-list:
  expression
  | expression-list ',' expression

```

Figure E-1. Grammar Syntax

### E.8. Grammar Examples

Examples of Yacc and Lex grammar are shown in [Figure E-2](#) and [Figure E-3](#), respectively. The grammar will recognize the derived syntax; that is, they will report whether or not a given text string is valid syntax; however, the examples are not intended to be complete; in other words, they will not compile or perform the calculation. The user needs only to build a program around them in order to use them; a simple example “main” is shown in [Figure E-4](#).

The Yacc is a parser generator developed by Stephen C. Johnson at American Telephone and Telegraph (AT&T) for the Unix operating system. It generates a parser, in C language code, based on an analytic grammar written in a notation similar to Backus-Naur Form (BNF). The Lex, a program that generates lexical analyzers, is commonly used along with the Yacc parser generator. Originally written by Eric Schmidt and Mike Lesk, Lex is the standard lexical

analyzer generator on many Unix systems. A tool exhibiting its behavior is specified as part of the Portable Operating System Interface standard.

```

% {
% }

%token ERR
%token NAME
%token CONSTANT

// Operator Precedence Rules (Lowest First, Highest Last)

%left ','
%right COND '?'
%left OR
%left AND
%left EQUAL NOTEQUAL
%left '<' '>' LESSEQUAL GREATEREQUAL
%left LSHIFT RSHIFT
%left '-' '+'
%left '*' '/' '%'
%left '|'
%left '^'
%left '&'
%left POWER
%right '! '~'
%right UMINUS

// Definition of Rules

%%
expression:
    expression '+' expression
    | expression '-' expression
    | expression '*' expression
    | expression '^' expression
    | expression '&' expression
    | expression '%' expression
    | expression LSHIFT expression
    | expression RSHIFT expression
    | expression POWER expression
    | expression '?' expression ':' expression %prec COND

```

Figure E-2. Yacc Grammar Example, Page 1 of 2

```
| '-' expression %prec UMINUS
| '!' expression
| '~' expression
| '(' expression ')'
| NAME
| CONSTANT
| NAME '(' expression_list ')'
| NAME '(' ')'
| expression '<' expression
| expression '>' expression
| expression LESSEQUAL expression
| expression GREATEREQUAL expression
| expression NOTEQUAL expression
| expression EQUAL expression
| expression OR expression
| expression AND expression
;

expression_list:
    expression
    | expression_list ',' expression
;

%%
```

Figure E-3. Yacc Grammar Example, Page 2 of 2



```

%{
#include "y.tab.h"
%}

%%

[ \t \n ]          {}

\|=|              { return(EQUAL); }          // Equal To
\!|=|            { return(NOTEQUAL); }        // Not Equal To
\<|<|=|          { return(LESSEQUAL); }        // Less Than or Equal To
\>|=|          { return(GREATEREQUAL); }     // Greater Than or Equal To
(\*|\*)         { return(POWER); }          // Power (FORTRANish)
\|||            { return(OR); }              // Logical OR
\&|\&          { return(AND); }             // Logical AND
\<|<|<          { return(LSHIFT); }          // Bitwise Left Shift
\>|\>          { return(RSHIFT); }          // Bitwise Right Shift

\>              |          // Greater Than
\<|<              |          // Less Than
\!|              |          // Logical Negation
\?|              |          // Ternary Operator ?
\:|              |          // Ternary Operator :
\%|              |          // Modulus (Remainder)
\,|              |          // Comma Operator (function)
\*|              |          // Multiplication (Product)
\|              |          // Division (Quotient)
\+|              |          // Addition (Sum)
\|              |          // Subtraction (Difference)
\|||            |          // Bitwise OR
\&|\&          |          // Bitwise AND
\^|              |          // Bitwise XOR
\~|              |          // Bitwise NOT
\(|             |
\)|             { return(yytext[0]); }

```

Figure E-4. Lex Grammar Example, Page 1 of 2

```

([0][xX][0-9a-fA-F+)]|([0-9]+)      {
    return(CONSTANT);
}

((([0-9]+\.[0-9]*)|([0-9]*\.[0-9]+))([eE][+]?[0-9]+)? {
    return(CONSTANT);
}

\"[^\n]*\"      |
\"[^\n]*\"      {
    return(NAME);
}

([0-9]+[a-zA-Z])?[a-zA-Z0-9$_\.\.]+ {
    return(NAME);
}

.          { return(ERR); }          // Catchall Error

%%

```

Figure E-5. Lex Grammar, Page 2 of 2

```

yywrap()
{
    return 1;
}
yyerror(char *s)
{
    printf("error: %s\n",s);
}
main()
{
    yyparse();
}

```

Figure E-6. Example Program (Main)

### E.9. Telemetry Attributes Transfer Standard (TMATS) Examples

In the following examples, input measurement names are in the form of MA, MB, and MC. Derived parameter names are in the form of DMA, DMB, and DMC.

E.9.a. TMATS Example 1

**DMA = MA + MB**

*Function style*

C-1\DCN:DMA;	Derived parameter
C-1\DCT:DER;	Derived conversion type
C-1\DPAT:N;	Name of algorithm will be given
C-1\DPA:+;	Addition operator
C-1\DPTM:MB;	Measurement MB triggers the calculation
C-1\DPNO:1;	Every sample of MB triggers the calculation
C-1\DP\N:2;	Two input measurements
C-1\DP-1:MA;	
C-1\DP-2:MB;	

*Formula style*

C-2\DCN:DMA;	
C-2\DCT:DER;	
C-2\DPAT:A;	Algorithm will be given
C-2\DPA:MA + MB;	Algorithm syntax
C-2\DPTM:MB;	
C-2\DPNO:1;	

E.9.b. TMATS Example 2

**DMB = MC / MD**

*Function style*

C-3\DCN:DMB;	Derived parameter
C-3\DCT:DER;	Derived conversion type
C-3\DPAT:N;	Name of algorithm will be given
C-3\DPA:/;	Division operator
C-3\DPTM:MD;	Measurement MD triggers the calculation
C-3\DPNO:1;	Every sample of MD triggers the calculation
C-3\DP\N:2;	Two input measurements
C-3\DP-1:MC;	
C-3\DP-2:MD;	

**Note:** In function style, the algorithm determines the meaning of the input measurements. In this example, the division algorithm assigns the first input measurement as the dividend and the second input measurement as the divisor.

*Formula style*

C-4\DCN:DMB;	
C-4\DCT:DER;	
C-4\DPAT:A;	Algorithm will be given
C-4\DPA:MC / MD;	Algorithm syntax
C-4\DPTM:MD;	
C-4\DPNO:1;	

E.9.c. TMATS Example 3

**DMC = square root of ME**

*Function style*

C-5\DCN:DMC;	Derived parameter
C-5\DCT:DER;	Derived conversion type
C-5\DPAT:N;	Name of algorithm will be given
C-5\DPA:SQRT;	Square root function
C-5\DP\N:1;	One input measurement
C-5\DP-1:ME;	

*Formula style*

C-6\DCN :DMC;	
C-6\DCT :DER;	
C-6\DPAT:A;	Algorithm will be given
C-6\DPA:SQRT(ME);	Algorithm syntax

**Note:** The trigger measurand is not given; there is only one input, which must trigger the calculation.

E.9.d. TMATS Example 4

**DMD = MF\*(SIN(MG/MH)+MJ)**

*Function style*

C-7\DCN:XA;	Derived parameter
C-7\DCT:DER;	Derived conversion type
C-7\DPAT:N;	Name of algorithm will be given
C-7\DPA:/;	Division operator
C-7\DP\N:2;	Two input measurements
C-7\DP-1:MG;	
C-7\DP-2:MH;	
C-8\DCN:XB;	Derived parameter
C-8\DCT:DER;	Derived conversion type
C-8\DPAT:N;	Name of algorithm will be given

C-8\DPA:SIN;	Sine function
C-8\DP\N:1;	One input measurement
C-8\DP-1:XA;	
C-9\DCN:XC;	Derived parameter
C-9\DCT:DER;	Derived conversion type
C-9\DPAT:N;	Name of algorithm will be given
C-9\DPA:+;	Addition operator
C-9\DP\N:2;	Two input measurements
C-9\DP-1:XB;	
C-9\DP-2:MJ;	
C-10\DCN:DMD;	Derived parameter
C-10\DCT:DER;	Derived conversion type
C-10\DPAT:N;	Name of algorithm will be given
C-10\DPA:*;	Multiplication operator
C-10\DP\N:2;	Two input measurements
C-10\DP-1:MF;	
C-10\DP-2:XC;	

**Note:** In this example, several steps are needed, each generating an intermediate result (XA, XB, and XC), before the derived parameter is obtained. This method is shown only for illustrative purposes and is not recommended. If this function is needed, a custom algorithm should be written to implement it. Then the function style could be used, as follows:

C-11\DCN:DMD;	Derived parameter
C-11\DCT:DER;	Derived conversion type
C-11\DPAT:N;	Name of algorithm will be given
C-11\DPA:NEWALG;	Name of custom algorithm
C-11\DPTM:MJ;	
C-11\DPNO:1;	
C-11\DP\N:4;	Four input measurements
C-11\DP-1:MF;	
C-11\DP-2:MG;	
C-11\DP-3:MH;	
C-11\DP-4:MJ;	

*Formula style*

C-12\DCN:DMD;	
C-12\DCT:DER;	
C-12\DPAT:A;	Algorithm will be given
C-12\DPA:MF*(SIN(MG/MH)+MJ);	
C-12\DPTM:MJ;	
C-12\DPNO:1;	

## E.10. Glossary of Terms

**Backus-Naur Form:** A metasyntax used to express context-free grammar; that is, a formal way to describe formal languages. John Backus and Peter Naur developed a context free grammar to define the syntax of a programming language by using two sets of rules: i.e., lexical rules and syntactic rules

**Compiler:** A computer program (or set of programs) that transforms source code written in a computer language (the source language) into another computer language (the target language, often having a binary form known as object code).

**Compiler (Compiler Generator):** A tool that creates a parser, interpreter, or compiler from some form of formal description. The earliest and still most common form of compiler-compiler is a parser generator, whose input is a grammar (usually in BNF) of a programming language, and whose generated output is the source code of a parser.

**Computer Programs:** Also called software programs, or just programs, are instructions for a computer.

**Grammar:** A set of formation rules that describe which strings formed from the alphabet of a formal language are syntactically valid within the language.

**Interpreter:** Normally means a computer program that executes instructions written in a programming language.

**Parser Generator:** See Compiler.

**Parsing:** The process of analyzing a sequence of tokens (for example, words) to determine their grammatical structure with respect to a given (more or less) formal grammar.

**Programming Language:** A machine-readable artificial language designed to express computations that can be performed by a machine, particularly a computer.

**Source Code:** Any collection of statements or declarations written in some human-readable computer programming language.

**Unix:** A computer operating system originally developed in 1969 by a group of AT&T employees at Bell Labs.

**Yet Another:** In hacker jargon, the use of yet another as a way of padding out an acronym is fairly common. It was first used by Stephen C. Johnson in the late 1970s in naming Yacc as a humorous reference to the proliferation of such compiler-compilers at the time.

**Yet Another Compiler Compiler (Yacc):** Supplied with Unix and Unix-like systems.

## APPENDIX 9-F

### Citations

Range Commanders Council. *IRIG Serial Time Code Formats*. RCC 200-16. August 2016. May be superseded by update. Retrieved 17 May 2021. Available at <https://www.trmc.osd.mil/wiki/x/wou8Bg>.

**\*\*\*\* END OF CHAPTER 9 \*\*\*\***



## CHAPTER 10

### Digital Recording Standard

<b>Acronyms</b> .....	<b>10-v</b>
<b>Chapter 10. Digital Recording Standard</b> .....	<b>10-1</b>
<b>10.1 General</b> .....	<b>10-1</b>
10.1.1 Digital Recorder Requirements.....	10-1
10.1.2 Interface Levels.....	10-3
<b>10.2 Definitions</b> .....	<b>10-3</b>
<b>10.3 Operational Requirements</b> .....	<b>10-3</b>
10.3.1 Recorder Compliance Requirements .....	10-3
10.3.2 Required Configuration .....	10-5
10.3.3 Exclusions to Standard.....	10-5
10.3.4 Internal System Management .....	10-5
10.3.5 Data Download .....	10-5
10.3.6 Host Platform Interface to Recorder Media.....	10-5
10.3.7 Required File Table Entries .....	10-6
10.3.8 Recorder Setup Configuration File .....	10-6
10.3.9 Recorder Data Streaming Transport .....	10-7
10.3.10 Commercial Off-the-Shelf Media.....	10-13
<b>10.4 Data Download and Electrical Interface</b> .....	<b>10-13</b>
10.4.1 Fibre Channel Recorder Download Interface .....	10-13
10.4.2 IEEE 1394b Recorder Interface .....	10-16
10.4.3 Ethernet Recorder Interface .....	10-16
<b>10.5 Interface File Structure Definitions</b> .....	<b>10-17</b>
10.5.1 Data Organization .....	10-17
10.5.2 Directory Definition.....	10-19
10.5.3 Data Definitions .....	10-22
<b>10.6 Data Format Definition</b> .....	<b>10-24</b>
10.6.1 IRIG 106 Chapter 11.....	10-24
10.6.2 Time Data Packets .....	10-26
<b>10.7 Recorder Control</b> .....	<b>10-27</b>
10.7.1 Recorder Control and Status .....	10-27
10.7.2 Communication Ports.....	10-27
10.7.3 RS-232/422 Port.....	10-27
10.7.4 Commands .....	10-27
10.7.5 Status Requests .....	10-27
10.7.6 Serial Status .....	10-27
10.7.7 Default Interface .....	10-28

10.7.8	Serial Commands .....	10-28
10.7.9	Required Discrete Control Functions.....	10-28
<b>10.8</b>	<b>Declassification .....</b>	<b>10-28</b>
<b>10.9</b>	<b>Host Platform Interface to Recorder Media .....</b>	<b>10-28</b>
10.9.1	Media Time Synchronization.....	10-28
10.9.2	Physical and Signaling.....	10-28
10.9.3	Removable Media Communication .....	10-29
10.9.4	RMM High-Level Command Handling.....	10-32
10.9.5	Mandated Connectors .....	10-33
10.9.6	Real-Time Clock.....	10-33
10.9.7	Mandatory Commands for RMM Devices .....	10-34
10.9.8	Date and Time Setting Requirements .....	10-34
10.9.9	Checking Battery Status.....	10-34
10.9.10	Declassification Supporting Commands.....	10-34
10.9.11	SCSI and iSCSI Devices.....	10-34
10.9.12	Using IEEE 1394b .....	10-34
10.9.13	Using Ethernet .....	10-34
<b>10.10</b>	<b>Ground-Based Recorders.....</b>	<b>10-34</b>
10.10.1	Interface .....	10-35
10.10.2	Data Format .....	10-35
10.10.3	Recording Media.....	10-35
10.10.4	Remote Command and Control .....	10-36
10.10.5	Data Replay and Reproduction .....	10-36
<b>10.11</b>	<b>Data Interoperability .....</b>	<b>10-36</b>
10.11.1	Original Recording Files.....	10-36
10.11.2	Modified Recording Files .....	10-37
10.11.3	Original Recording and Modified Recording File Extension .....	10-38
10.11.4	File Naming .....	10-38
10.11.5	Data Transfer File .....	10-40
10.11.6	Recording Directory File .....	10-41
<b>Appendix 10-A.</b>	<b>Definitions .....</b>	<b>A-1</b>
<b>Appendix 10-B.</b>	<b>Sanitization.....</b>	<b>B-1</b>
<b>B.1.</b>	<b>Approach .....</b>	<b>B-1</b>
<b>B.2.</b>	<b>Algorithm.....</b>	<b>B-1</b>
<b>Appendix 10-C.</b>	<b>Citations .....</b>	<b>C-1</b>

**Changes to This Edition of Chapter 10**

No changes to Chapter 10 were included in developing 106-22.

**List of Figures**

Figure 10-1.	Functional Layout of Digital Recorder Standard.....	10-2
Figure 10-2.	UDP Transfer Format 1 Header for Non-Segmented Data.....	10-8
Figure 10-3.	UDP Transfer Format 1 Header for Segmented Data.....	10-9
Figure 10-4.	UDP Transfer Format 1 (Full Packets).....	10-10
Figure 10-5.	UDP Transfer Format 1 (Segmented Packet).....	10-10
Figure 10-6.	UDP Transfer Format 2 Header.....	10-10
Figure 10-7.	UDP Transfer Format 2 (Segmented Packet).....	10-11
Figure 10-8.	UDP Transfer Format 3 Header.....	10-11
Figure 10-9.	Directory Structure.....	10-18
Figure 10-10.	Directory Block.....	10-19
Figure 10-11.	File Name Examples.....	10-24
Figure 10-12.	Data Recording Structure.....	10-25
Figure 10-13.	Removable Media.....	10-29

**List of Tables**

Table 10-1.	On-Board Recorder Mandatory Compliance Requirements.....	10-4
Table 10-2.	Ground-Based Recorder Mandatory Compliance Requirements.....	10-4
Table 10-3.	Source Field Lengths.....	10-11
Table 10-4.	Offset Field Meanings.....	10-12
Table 10-5.	Required and Recommended SCSI Commands, Features, and Parameters.....	10-14
Table 10-6.	Directory Block Format.....	10-19
Table 10-7.	Data File Entry Format.....	10-20
Table 10-8.	Prohibited Characters (Hexadecimal Representation).....	10-23
Table 10-9.	Required Packets and Locations.....	10-26
Table 10-10.	Ethernet Service Location Protocol Characteristics.....	10-30

This page intentionally left blank.

## Acronyms

BCS	basic character set
CCM	command and control mnemonics
CDB	command descriptor block
CLI	command line interface
COTS	Commercial Off-the-Shelf
DHCP	Dynamic Host Control Protocol
EUI	enterprise-unique identifier
FC-PLDA	Fibre Channel Private Loop SCSI Direct Attach
FTP	file transfer protocol
IAW	in accordance with
IEEE	Institute of Electrical and Electronics Engineers
IETF	Internet Engineering Task Force
IP	Internet Protocol
IPv4	Internet Protocol version 4
IPv6	Internet Protocol version 6
IQN	iSCSI qualified name
IRIG	Inter-Range Instrumentation Group
iSCSI	Internet Small Computer Systems Interface
ISO	International Organization for Standards
ITU-T	International Telecommunications Union/Telecommunication Standardization Sector
kb	kilobyte
lsb	least significant bit
LUN	logical unit number
Mbps	megabit per second
MHz	megahertz
MIL-STD	Military Standard
mm	millimeter
ms	millisecond
msb	most significant bit
MTU	maximum transmission unit
NADSI	NATO Advanced Data Storage Interface
NATO	North Atlantic Treaty Organization
ORB	operation request block
PoE	Power Over Ethernet
ppm	parts per million
RCC	Range Commanders Council
RFC	Request For Comment
RMM	removable memory module
RS	Recommended Standard
RSCF	recorder setup configuration file
RTC	relative time counter
SBP	Serial Bus Protocol
SCSI	Small Computer Systems Interface
SLP	service location protocol

STANAG	Standardization Agreement
TCP	Transmission Control Protocol
UDP	User Datagram Protocol
UO	unexpected one
UZ	unexpected zero

## CHAPTER 10

### Digital Recording Standard

#### 10.1 General

A large number of unique and proprietary data structures has been developed for specific data recording applications that required unique decoding software programs. The activities of writing unique decoding software, checking the software for accuracy, and decoding the data tapes are extremely time-consuming and costly. In the late 1990s, the test ranges started to see the implementation of non-tape-based, high-data-rate recorders, the most predominant of which were solid-state memory devices. Then, as high-data-rate digital recorders were fielded and as solid-state technology began to emerge, the Telemetry Group saw the need and formed an ad hoc committee for a computer-compatible digital data acquisition and recording standard.

##### 10.1.1 Digital Recorder Requirements

There is a need for a digital data acquisition and recording standard (see the functional layout at [Figure 10-1](#)) that supports a broad range of requirements, including:

- a. Data download and interface
- b. One or more multiplexed data streams
- c. One or more single-data streams
- d. Data format definitions
- e. Recorder control
- f. Media declassification
- g. Data interoperability

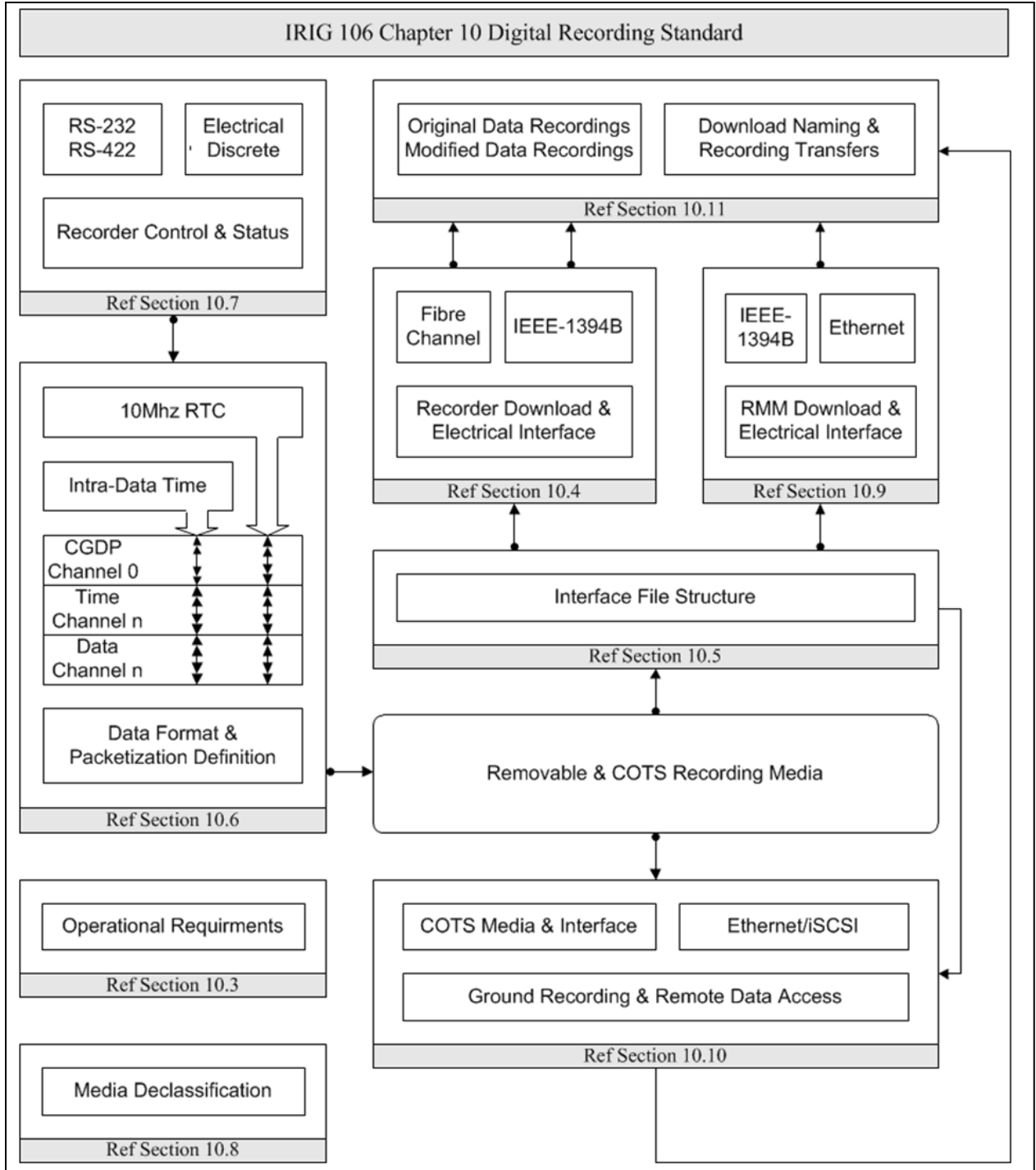



Figure 10-1. Functional Layout of Digital Recorder Standard

Specifically, this digital recording standard shall be compatible with the multiplexing of both synchronous and asynchronous digital inputs such as pulse code modulation and Military Standard (MIL-STD) 1553 data bus, time, analog, video, Aeronautical Radio, Inc. 429, discrete, and Universal Asynchronous Receiver and Transmitter containing Recommended Standard (RS)-232/422/485 communication data. This digital recording standard will allow use of a



common set of playback/data reduction hardware/software to take advantage of emerging random access recording media.

 <p><b>NOTE</b></p>	<p>Within this standard, where text, figures, or tables are used to provide descriptions, meaning, and/or explanations, the text shall take precedence over figures and tables.</p>
--	---

### 10.1.2 Interface Levels

The purpose of this chapter is to establish a common interface standard for the implementation of digital data acquisition and recording systems by the organizations participating in the Range Commanders Council (RCC). This standard does not imply hardware architecture such as the coupling of data acquisition, multiplexing, and media storage. The required interface levels are contained in this standard.

- a. Data Download and Electrical Interface, which is the physical interface for data access, is defined in Section [10.4](#).
- b. Interface File Structure, which defines data access structure, is described in Section [10.5](#).
- c. Data Format Definition, which defines data types and packetization requirements, is defined in Section [10.6](#).
- d. Recorder Control and Status, which defines command and control mnemonics (CCM), status, and their interfaces, is described in Section [10.7](#).
- e. Host Platform Interface to Recorder Removable Media is defined in Section [10.9](#).
- f. Ground-Based Recorder Interface, which defines unique interoperability requirements of a ground-based recorder, is described in Section [10.10](#).
- g. Data Interoperability, which defines requirements for the annotation, modification, and exchange of recorded data, is described in Section [10.11](#).

## 10.2 **Definitions**

As of RCC 106-13 published June 2013, the definitions that in previous versions comprised this section are now located in [Appendix 10-A](#).

## 10.3 **Operational Requirements**

On-board recorders are the basis and original justification for this standard. This section defines the requirements for on-board recorders to be in 100 percent compliance.

### 10.3.1 Recorder Compliance Requirements

[Table 10-1](#) and [Table 10-2](#) represent the mandatory recorder requirements to meet 100 percent compliance with this standard. Meeting these compliance requirements guarantees interoperability of recorders, recorder media, and recorded data. Optional functions and/or capabilities are not shown but when implemented in a recorder shall be in accordance with (IAW) the definitions in this standard in order to meet 100 percent compliance of this standard.

<b>Table 10-1. On-Board Recorder Mandatory Compliance Requirements</b>	
<b>Applicable Compliance Section</b>	<b>Function/Capability</b>
<b>Recorder Electrical Interfaces</b>	
<a href="#">10.3</a> , <a href="#">10.4</a>	Fibre Channel and/or IEEE 1394b Data Download Port
<a href="#">10.3</a> , <a href="#">10.7</a>	Discrete Lines and/or RS-232 and 422 Full Duplex Communication
<a href="#">10.3</a>	External Power Port
<b>Recorder Download Interface Protocols</b>	
<a href="#">10.4</a> , <a href="#">10.9</a>	Fibre Channel SCSI and/or IEEE 1394b SCSI/SBP-2
<b>Recorder Control/Status Interface Protocols</b>	
<a href="#">10.7</a>	Discrete Control/Status and/or RS-232 and 422 Control/Status
<b>Removable Memory Module (RMM) Electrical Interface and Power</b>	
<a href="#">10.3</a> , <a href="#">10.9</a>	IEEE 1394b Bilingual Socket or Ethernet 8P8c/RJ45
<b>Commercial Off-the-Shelf (COTS) Media Electrical Interfaces</b>	
<a href="#">10.3</a>	COTS Media Interface
<b>RMM Interface Protocols</b>	
<a href="#">10.9</a>	IEEE 1394b SCSI/SBP-2 or IEEE 802.3 IPv4
<b>COTS Media Interface Protocols</b>	
<a href="#">10.3</a>	COTS Media Interface
<b>Recorder Media/RMM/COTS Media Interface File Structure</b>	
<a href="#">10.5</a>	Directory, File Structures, and Data Organization
<a href="#">10.3.7</a>	Directory and File Table Entries
<b>Packetization and Data Format</b>	
<a href="#">10.6</a>	Packet Structures, Generation, Media Commitment, Time Stamping, and Data Type Formats
<b>Data Interoperability</b>	
<a href="#">10.11</a>	Original Recording Files

<b>Table 10-2. Ground-Based Recorder Mandatory Compliance Requirements</b>	
<b>Applicable Compliance Section</b>	<b>Function/Capability</b>
<b>Recorder Electrical Interfaces</b>	
<a href="#">10.10</a>	Ethernet
<b>Recorder Remote Interface Protocols</b>	
<a href="#">10.10</a> , <a href="#">10.4</a>	Internet Small Computer Systems Interface (iSCSI) and/or Telnet
<b>COTS Media Electrical Interfaces</b>	
<a href="#">10.10</a>	COTS Media Interface
<b>COTS Media Interface Protocols</b>	
<a href="#">10.10</a>	COTS Media Interface
<b>Remote Data Access Interface File Structure</b>	
<a href="#">10.5</a>	Directory, File Structures, and Data Organization

<b>Table 10-2. Ground-Based Recorder Mandatory Compliance Requirements</b>	
<b>Applicable Compliance Section</b>	<b>Function/Capability</b>
<a href="#">10.3.7</a>	Directory and File Table Entries
<b>Packetization and Data Format</b>	
<a href="#">10.6</a>	Packet Structures, Generation, Media Commitment, Time Stamping, and Data Type Formats
<b>Data Interoperability</b>	
<a href="#">10.11</a>	Original Recording Files

### 10.3.2 Required Configuration

An on-board recorder, as a minimum, shall provide the following functionality.

- a. Data download port
- b. Recorder control/maintenance port
- c. External power port

The required data download port interface shall be IAW Section [10.4](#). This combination will allow data extraction and transfer from any recorder to any Section [10.4](#)-compliant intermediate storage unit. The required control port interface shall be IAW Section [10.7](#).

### 10.3.3 Exclusions to Standard

The physical size, configuration, and form factor for the on-board recorder and the RMM are not controlled by this standard. Due to the variation in capacity/rate/cost requirements of the users, this standard does not specify the technology to be used in the RMM or the on-board recorder.

### 10.3.4 Internal System Management

Any processing performed on the stored data by the on-board recorder (e.g., for the purposes of internal system management, error detection and correction, physical frame formatting, etc.) shall be removed from the stored data when the stored data is downloaded or transferred from storage media.

### 10.3.5 Data Download

On-board recorders may have an RMM capability or the on-board recorder can be removed from the acquisition platform and taken to a ground station for data download. Refer to Subsection [10.4.1](#) for recorder download and electrical interface, Section [10.9](#) for RMM interface, and Section [10.11](#) for data transfer and file management.

### 10.3.6 Host Platform Interface to Recorder Media

Interface to on-board recorder media shall be accomplished utilizing IEEE 1394b or Ethernet interfaces. Interface connectors IAW Subsection [10.9.5](#) shall be provided on the media to allow direct download of data to the host computer or storage device.

### 10.3.7 Required File Table Entries

Within Section [10.5](#), [Table 10-7](#) File Size, File Create Date, File Create Time, and File Close Time are either optional or can be empty (filled with 0x2D) if data is unavailable. [Table 10-7](#) has been adopted from Standardization Agreement (STANAG) 4575<sup>1</sup> but in the case of Chapter 10 unless Time Type is 0xFF (time data packet) and the time data packet source is 0xF (None) date and time will always be available.

#### 10.3.7.1 File Table Entry Conditions

If [Table 10-6](#) Shutdown value is 0xFF or 0x00 and Time Type is 0xFF and the time data packet source is not 0xF File Size, File Create Date, File Create Time, and File Close Time entries shall be filled in their entirety.

### 10.3.8 Recorder Setup Configuration File

A recorder setup configuration file (RSCF) can reside on the recorder or optionally reside in the RMM. Recorder setup configuration must be IAW [Chapter 9](#). Recorder setup configurations shall be programmed IAW Section [10.7](#). Optionally the recorder can be configured from a Chapter 10 configuration file residing in the RMM. The RMM RSCF will have priority over setup records residing in the recorder.

#### 10.3.8.1 Recorder Configuration File Location

When a setup record transfer to a recorder is made via the RMM Computer-Generated Data, Format 1 setup record packet(s) will be used. The RMM shall contain a directory and one directory block file entry IAW Subsection [10.5.2](#).

- a. All directory block format fields shall be IAW [Table 10-6](#). The field *n* File Entries value shall be 1.
- b. All directory entry format fields shall be IAW [Table 10-7](#). The field “Time Type” value shall be 0x01, System time. The field “Name” value shall be:

recorder\_configuration\_file\_SAVE\_n

This will notify the recorder to use the recorder configuration transfer file for the next recording and store the setup information contained within the file to non-volatile memory in the recorder pre-defined setup location *n*, where *n* is a value of 0-15. This shall be the equivalent of sending .TMATS SAVE [*n*] and .SETUP [*n*] commands.

#### 10.3.8.2 Recorder Configuration File Structure

The RSCF structure will only contain Computer-Generated Data, Format 1 setup record packets. More than one packet is allowed only if the required recorder configuration information exceeds the packet size limits in Subsection [10.6.1](#), thus forcing more than one Computer-Generated Data, Format 1 setup record packet. The standard method of using the sequence counter will be utilized until all the configuration information has been packetized.

---

<sup>1</sup> North Atlantic Treaty Organization. “NATO Advanced Data Storage Interface (NADSI).” STANAG 4575 (Edition 3). 8 May 2009. Superseded by NATO Standard AEDP-6 Edition B Version 4, published September 2020. Superseding document retrieved 17 May 2021. Available at <https://nso.nato.int/nso/zPublic/ap/PROM/AEDP-06%20EDB%20V4%20E.pdf>.

### 10.3.8.3 Configuration of Recorder from RMM

A setup record may reside in the RMM and be utilized for configuration of the recorder. A Computer-Generated Data, Format 1 setup record packet(s) will be used. The RMM shall contain a directory and at least one directory block file entry IAW Subsection [10.5.2](#).

- a. All directory block format fields shall be IAW [Table 10-6](#). The field “*n* File Entries” value shall be 1.
- b. All directory entry format fields shall be IAW [Table 10-7](#). The field “Time Type” value shall be 0x01, System time. The field “Name” value shall be:

recorder\_configuration\_file\_SETUP\_RMM

This will notify the recorder to configure from the RMM. The RSCF shall NOT be able to be erased by the recorder .ERASE or DISCRETE command.

### 10.3.9 Recorder Data Streaming Transport

Data streaming transport may be accomplished across the Section [10.4](#) recorder download and electrical interfaces using the definitions in Section [10.2](#) and commands in [Chapter 6](#). For ground-based recorders, this will be accomplished across the required remote data access Ethernet interface.

The active configuration of the recorder can be detected by means of Chapter 11 Computer-Generated Data Packet, Format 4 Streaming Configuration packets inserted into the reserved channel ID 0x0000.

#### 10.3.9.1 IP Streaming

The network interface, such as Ethernet, can be used for data streaming over Internet Protocol (IP) using either User Datagram Protocol (UDP/IP) or Transmission Control Protocol (TCP/IP). This shall be controlled with the Chapter 6 PUBLISH command.

A network stream is defined, as described in [Chapter 6](#) section 6.2.4.22, as a sequence of packets with a common network source/destination and set of channels. Multiple concurrent network streams may be supported.

When streaming data over IP networks, the Stream Commit Time requirement shall apply to the time at which the data is made available for transmission by the network subsystem.

IP Streaming may use either IPv4 or IPv6.

 <p><b>NOTE</b></p>	<p>As IP networks are non-deterministic with respect to timing, packets may be delayed, lost, and/or resent, which may result in an unpredictable delay between the packet being made available for transmission and it being received.</p>
--	---

 <p><b>NOTE</b></p>	<p>The IP protocol supports low-level packet sizes up to 64 kb; however, common IP transports such as Ethernet impose restrictions on the size of the maximum transmission unit (MTU), beyond which fragmentation is required. It is generally desirable to manage streaming data so that fragmentation is avoided. For Ethernet, an MTU of 1500 bytes is common, unless “jumbo frames” are enabled, in which case an MTU of around 9000 bytes is typical.</p>
--	--

An IPv4 datagram is limited to 65,507 bytes, which is significantly less than the maximum size of a Chapter 11 packet. An IPv6 datagram may support “jumbograms” that support payloads larger than the maximum permitted Chapter 11 packet size, but support of this feature is not guaranteed by every IPv6 device. A UDP transfer header shall be used to support all valid Chapter 11 packets and to help protect against undetected data loss.

Three UDP transfer header formats are defined. Format 1 has been supported since IRIG 106-11 and was specifically designed to support streaming data from a recorder to a monitoring station. Format 2 is documented to reflect existing but legacy hardware but is not recommended for use in new applications. Format 3 has been designed to add support for distributed acquisition systems; it supports streaming both to and from the recorder.

Format 3 is recommended for all new designs.

*10.3.9.1.1 Ethernet Packet Payload Byte Order*

The byte ordering of the streamed packet payload (i.e., the Chapter 11 packets) shall be IAW Subsection [10.5.3.2](#).

 <p><b>NOTE</b></p>	<p>The IP, TCP and UDP network headers use “big endian” byte ordering, also known as “network byte ordering”.</p>
--	---

The byte order of the UDP/IP transfer header is explicitly defined as part of the definition of the header.

*10.3.9.1.2 Format 1, UDP Transfer Header*

The structure shown in [Figure 10-2](#) shall be used for Format 1 UDP transfer headers in datagrams containing one or more full Chapter 11 data packets. The UDP transfer header, Format 1 uses “little endian” byte ordering.

Most Significant Bit (msb)	Least Significant Bit (lsb)			
31	8	7	4	3 0
UDP Message Sequence Number	Type of message		Format	

Figure 10-2. UDP Transfer Format 1 Header for Non-Segmented Data

The structure in [Figure 10-3](#) shall be used for Format 1 UDP transfer headers in UDP datagrams containing a segmented Chapter 11 data packet.

msb				lsb	
31		8	7	4	3 0
UDP Message Sequence Number			Type of message		Format
31	24	23	16	15	0
Reserved		Channel Sequence Number		Channel ID	
Word 5			Word 4		
msb				lsb	
31					0
Segment Offset					

Figure 10-3. UDP Transfer Format 1 Header for Segmented Data

Format (4 bits)

- 0000: Reserved
- 0001: Format 1 (This format)
- 0010: Format 2
- 0011: Format 3
- 0100-1111: Reserved

Type of Message (4 bits)

- 0000: Full packets
- 0001: Segmented
- 0010-1111: Reserved

UDP Message Sequence Number (24 bits). Binary value incrementing by one for each UDP message even if segment of Chapter 10 packet.

Channel ID (16 bits). Segmented packets only, channel ID of the data in the Chapter 10 packet.

Channel Sequence Number (8 bits). Segmented packets only, channel sequence number of the data in the Chapter 10 packet.

Reserved (8 bits). Reserved.

Segment Offset (32 bits). Segmented packets only, position of the data in the Chapter 10 packet.

*10.3.9.1.3 Format 1, UDP Chapter 11 Packet Transfer*

When more than one complete Chapter 11 packet is contained within a UDP datagram, there shall be an integral number of Chapter 11 packets. The packets shall be sent in the same sequence as the recording segment of a packet and shall be ordered (segment offset incrementing). [Figure 10-4](#) and [Figure 10-5](#) present the sequence of the general UDP network transmission of full or segmented packets.

UDP/IP Headers
UDP Transfer Header, Format 1
Chapter 11 Packet 1
:
Chapter 11 Packet N

Figure 10-4. UDP Transfer Format 1 (Full Packets)

UDP/IP Headers
UDP Transfer Header, Format 1
Chapter 11 Packet Segment

Figure 10-5. UDP Transfer Format 1 (Segmented Packet)

10.3.9.1.4 Format 2, UDP Transfer Header

The structure shown in [Figure 10-6](#) shall be used for Format 2 UDP transfer headers in datagrams. Format 2 uses “big endian” or network byte ordering for the header:

MSW				LSW			
31		8	7	4	3	0	
Sequence Number				Type		Format	
31	24	23				0	
Segment Offset				Packet Size			
31	16		15		0		
Segment Offset				Channel Number			

Figure 10-6. UDP Transfer Format 2 Header

Format (4 bits)

- 0000: Reserved
- 0001: Format 1
- 0010: Format 2 (This format)
- 0011: Format 3
- 0100-1111: Reserved

Type of Message (4 bits)

- 0000: Chapter 11 packet contains a complete Chapter 10 packet
- 0001: Chapter 11 packet contains a partial Chapter 10 packet
- 0010-1111: Reserved

UDP Message Sequence Number (24 bits). Binary value incrementing by one for each Chapter 11 packet.

Channel ID (16 bits). Channel ID of the embedded Chapter 11 packet.

Packet Size (24 bits). Size of the complete Chapter 11 packet in units of 32 bits.

Segment Offset (24 bits). Offset for this data in the Chapter 11 packet in units of 32 bits.

As shown in [Figure 10-7](#), all Chapter 11 packets shall be sent contained within 1 or more UDP datagrams. Each datagram shall contain a payload of 1472 bytes or less. Each datagram shall contain 1 or more whole or partial Chapter 11 packets. A datagram may begin and/or end with a partial Chapter 11 packet, or contain a single partial Chapter 11 packet. A datagram may



contain multiple whole Chapter 11 packets. Every whole or partial Chapter 11 packet contained within a UDP datagram is prefixed with a Version 2 UDP transfer header.

UDP/IP Headers
UDP Transfer Header, Format 2
Chapter 11 Packet Segment N-1
UDP Transfer Header, Format 2
Chapter 11 Packet N
UDP Transfer Header, Format 2
Chapter 11 Packet Segment N+1

Figure 10-7. UDP Transfer Format 2 (Segmented Packet)

10.3.9.1.5 Format 3, UDP Transfer Header

The structure shown in [Figure 10-8](#) shall be used for Format 3 UDP transfer headers in UDP datagrams. Format 3 uses “little endian” byte ordering for the header:

msb						lsb																									
31				16				15				8				7				4				3				0			
Offset to Packet Start								Reserved								SrcID Len				Format											
Source ID								Datagram Sequence Number																							

Figure 10-8. UDP Transfer Format 3 Header

Format (4 bits)

- 0000: Reserved
- 0001: Format 1
- 0010: Format 2
- 0011: Format 3 (This format)
- 0100-1111: Reserved

SrcID Len (4 bits). Number of bits in the Source ID field. Permissible values are 0 to 4, which defines the number of 4-bit “nibbles” to be used with the interpretation shown in [Table 10-3](#).

<b>Table 10-3. Source Field Lengths</b>			
<b>“SrcID Len” Value</b>	<b>Length of “Source ID” (bits)</b>	<b>Max. Number of Sources</b>	<b>Length of Datagram Sequence Number (bits)</b>
0	0	1	32
1	4	16	28
2	8	256	24
3	12	4096	20
4	16	65536	16

The purpose of this field is to provide enough information to detect when the datagram sequence number “wraps”; the median value of 2 is recommended as a good compromise between the maximum number of sources on the same network (which is controlled by the length of the “Source ID” field) and resilience against undetected “wrapping”, which requires a large datagram sequence number.

Offset to Packet Start (16 bits). Offset, in bytes, to the start of the first Chapter 11 packet within the datagram. As the Format 3 UDP transfer header is 8 bytes in length, values less than 8 cannot refer to the start of a packet, and instead are used to designate the conditions indicated in [Table 10-4](#).

<b>Value</b>	<b>Meaning</b>
0	No Chapter 11 packet starts in this datagram (i.e., this is datagram is entirely a partial packet).
1	The sending device has no information about whether a Chapter 11 packet starts in this datagram.
2	The datagram size is an IPv6 “jumbogram” larger than 64 kb and no Chapter 11 packet starts in the first 64 kb of the jumbo datagram.
8 – 65,507	The first byte of the first Chapter 11 packet in this datagram is located at this offset from the start of the datagram.

The use of the special value “1” is discouraged except in the case of “bridge” or routing devices that have no inherent knowledge of Chapter 11 packet structure.

Source ID (0 to 16 bits, depending on “SrcID Len” field). Value indicating which of a number of devices is generating this packet stream; must be unique on the network. Assignment of this value is not controlled by this standard, and has no inherent meaning other than as an identifier.

Datagram Sequence Number (16 to 32 bits, depending on “SrcID Len” field). This is a monotonically increasing sequence number for each datagram sent for a given network stream. This sequence number will wrap from “all 1s” to 0.

<b>NOTE</b> 	The core features of the original Format 1 UDP transfer header can be provided by setting “SrcID Len” to 0 and ignoring the ability to have multiple sources.
--	---

#### 10.3.9.1.6 Format 3, UDP Chapter 11 Packet Transfer

In Format 3, the Chapter 11 packet stream may be packed into as many or as few discrete UDP datagrams as suits the implementation. This facilitates the use of datagrams sized to fit the MTU of the transmission medium (e.g., Ethernet).

#### 10.3.9.2 TCP Data Transfer

When supporting TCP/IP streaming, the recorder can act either as client (i.e., it establishes the connection to the remote device) or a server (i.e., it waits for a connection from the remote device). When acting as a server, the default port for TCP/IP connections is defined to be (decimal) 10620.

Using TCP/IP, Chapter 11 packets are transmitted in the exact same format (byte for byte) as they would be written to local storage media.

The data availability (e.g., the channel selection) can be controlled with the remote control command: `.PUBLISH_TCP` (see [Chapter 6](#)).

When a TCP connection is first established, the first byte transmitted shall be the first byte of a Chapter 11 packet.

#### 10.3.9.3 Non-IP Streaming

Streaming over connections that do not support IP are treated identically to TCP/IP data transfer as described in Subsection [10.3.9.2](#).

[Chapter 7](#) provides a Non-IP Streaming mode for Chapter 11 packets.

#### 10.3.10 Commercial Off-the-Shelf Media

In conjunction with an on-board recorder and/or a multiplexer when an RMM or internal on-board recorder media is not used, COTS media can be used for recording media. The COTS media shall be accessible at a minimum from the on-board recorder data download port IAW Section [10.4](#) and optionally by at least one COTS media interface. When accessing COTS media the interface file structure definition defined in Section [10.5](#) shall be presented at the on-board recorder or COTS media interface.

### 10.4 Data Download and Electrical Interface

The required recorder download port interface (see Subsection [10.3.2](#)) shall be Fibre Channel, IEEE 1394b, Ethernet (Subsection [10.4.3](#)), or any combination of the three. The physical, signaling, and command protocols contained in subsections [10.4.1](#) and [10.4.2](#) are a subset of, and adapted from STANAG 4575.

#### 10.4.1 Fibre Channel Recorder Download Interface

##### 10.4.1.1 Physical and Signaling

The interface shall comply with Fibre Channel-Physical Interfaces and Fibre Channel-Framing and Signaling in Section [10.9](#), with configuration options as specified.

- a. Physical Media. Fibre Channel copper interface will be utilized.
- b. Signaling Rate. The transmission signaling rate shall be 1.0625 gigabaud.

##### 10.4.1.2 Command Protocol

The interface shall conform to the requirements of the Fibre Channel Private Loop SCSI Direct Attach (FC-PLDA) (American National Standards Institute/International Committee for Information Technology Standards TR19-1998)<sup>2</sup> interoperability, except as defined herein. Table 17 of FC-PLDA specifies a control protocol using a subset of commands, features, and parameters defined for the Small Computer System Interface (SCSI)-3. Table 17 of FC-PLDA also defines the command feature and parameter usage categories of “Required,” “Allowed,” “Invokable,” and “Prohibited” between the SCSI initiator and target. These definitions assume that the target is a magnetic disk drive or equivalent device.

---

<sup>2</sup> International Committee for Information Technology Standards. “Fibre Channel - Private Loop SCSI Direct Attach (FC-PLDA).” INCITS TR-19-1998. January 1998. Retrieved 17 May 2021. Available for purchase at <http://www.techstreet.com/incits/searches/385689>. Replaced by “INCITS Technical Report - for Information Technology - Fibre Channel - Device Attach (FC-DA).” INCITS TR-36-2004. February 2005. Retrieved 17 May 2021. Available for purchase at <http://www.techstreet.com/incits/searches/385707>.

The control protocol must support a number of data storage media types. Only the minimum set of SCSI commands needed to download mission data from a memory cartridge are defined as “Required.” The FC-PLDA SCSI commands, features, and parameters not defined as “Required” for this standard are redefined as “Allowed” so that they may be implemented as appropriate. In addition, it is recognized that numerous applications will be required to write to the RMM as well. Commands required to format and/or write to an RMM are defined as “Recommended.” These commands are not required for any STANAG 4575 RMM implementation; however, if the functions are incorporated into an application, the recommended commands shall be used to preclude a proliferation of unique commands. All other required FC-PLDA SCSI commands, features, and parameters not defined as “Required” or “Recommended” for STANAG 4575 are redefined as “Allowed” such that they may be implemented as appropriate. [Table 10-5](#) provides the five required STANAG 4575 SCSI commands and two recommended commands and their features and parameter usage definitions. The NATO Advanced Data Storage Interface (NADSI)-compliant recorders may respond to the inquiry command with a 00h SCSI version code and the ground/shipboard NADSI host must be prepared to accept this response and restrict SCSI commands issued to the STANAG 4575 mandatory set.

<b>Table 10-5. Required and Recommended SCSI Commands, Features, and Parameters</b>			
<b>Feature (Command)</b>	<b>Initiator</b>	<b>Target*</b>	<b>Notes</b>
Inquiry	I	R	
Standard INQUIRY data (bytes 0-35)	I	R	
Enable Vital Product Data= 1	I	R	
Enable Vital Product Data page codes:			
0x00 (supported vital product pages)	I	R	
0x80 (unit serial number page)	I	R	
0x81 (implemented operations definition page)	I	A	
0x82 (Basic Character Set [BCS] implemented operations definition page)	I	A	
0x83 (device identification page)	I	R	
Read (10)	I	R	
DPO = 0	I	A	1
DPO = 1	I	A	1
FUA = 0	I	A	2
FUA = 1	I	A	2
RelAdr= 0	R	R	
RelAdr= 1	P	P	3
Read Capacity	I	R	
RelAdr= 0	R	R	
RelAdr= 1	P	P	3
PMI = 0	I	R	
PMI = 1	I	A	
Test Unit Ready	I	R	
Request Sense	I	R	

Write (10)	C	C	4
DPO = 0	I	A	1
DPO = 1	I	A	1
FUA = 0	I	A	2
FUA = 1	I	A	2
RelAdr= 0	C	C	
RelAdr= 1	P	P	3
Format Unit	C	C	4, 5
FMT DATA = 0	I	A	
CMPLST = 0	I	A	
DEFECT LIST FMT= 0	I	A	
INTERLEAVE = 0	I	A	
Notes			
<ol style="list-style-type: none"> <li>1. The Disable Page Out (DPO) bit is associated with a device data caching policy.</li> <li>2. The Force Unit Access (FUA) bit is associated with whether the device may or may not return the requested read data from its local cache.</li> <li>3. Relative offset is prohibited since this requires the use of linking, which is prohibited.</li> <li>4. All RMMs not supporting recommended or allowed commands shall respond to these commands with an appropriate error response and shall not cease operations.</li> <li>5. The FORMAT command shall implement an initialization of the target device such that the entire user memory space shall be writable. After performing this command, the content of the memory may be indeterminate.</li> </ol>			
*LEGEND			
P Prohibited: The feature shall not be used between NADSI-compliant devices.			
R Required: The feature or parameter value shall be implemented by NADSI-compliant devices.			
C Recommended: The feature is recommended and shall be used for applications requiring the functionality of these commands. The initiator determines if a recommended feature/parameter is supported via a required discovery process or a minimal response by the recipient.			
A Allowed: The feature or parameter may be used between NADSI-compliant devices. The initiator determines if an allowed feature/parameter is supported via a required discovery process or a minimal response by the recipient.			
I Invokable: The feature or parameter may be used between NADSI-compliant devices. The recipient shall support invokable features or provide a response that it is not implemented as defined by the appropriate standard.			

The RMM shall provide Fibre Channel responder functionality and the NATO ground station shall provide Fibre Channel originator functionality. The RMM shall also provide SCSI target functionality and the NATO ground station shall provide SCSI initiator functionality. When an RMM is powered up directly through the NADSI interface, the RMM shall automatically initialize into a mode where the NADSI port is active and is the priority data and control interface.

#### 10.4.2 IEEE 1394b Recorder Interface

The IEEE 1394b recorder download interface shall use the same mechanisms as Section [10.9](#) where applicable.

##### 10.4.2.1 Physical and Signaling

The interface shall allow control of vendor-specific recorder devices. The command protocol shall be IAW Subsection [10.4.1.2](#) and [Table 10-5](#).

##### 10.4.2.2 Recorder Communication

The fundamental method of communicating shall be IAW the IEEE 1394b protocol.<sup>3</sup> Packets sent and received shall be asynchronous transmissions. The IEEE 1394b packets shall encapsulate Serial Bus Protocol (SBP)-2 formatted packets for the transport of commands and data. Recorder devices are to use SCSI command set(s) and therefore SCSI commands and status shall be encapsulated in SBP-2 operation request blocks (ORBs).

 <p><b>NOTE</b></p>	<p>The SBP-2 provides for the transport of 6-, 10-, and 12-byte SCSI command descriptor blocks (CDBs) within a command ORB.</p>
--	---

#### 10.4.3 Ethernet Recorder Interface

For a recorder containing an Ethernet interface for the data download port, FTP and/or iSCSI protocols shall be used. If FTP will be implemented the requirements set forth in Subsection [10.9.3.4](#) shall be followed. If the iSCSI protocol is to be implemented then the host ground system will act as the *initiator* and the recorder will act as the *target*.

The recorder Ethernet interface shall use the Telnet protocol. As a minimum requirement, the Telnet interface will implement Internet Engineering Task Force (IETF) Request for Comment (RFC) 854<sup>4</sup>, RFC 855<sup>5</sup>, and RFC 1184.<sup>6</sup> The protocol will support Chapter 6 CCM (Subsection [10.7.8](#)) over a TCP/IP connection on port # 10610. The Telnet interface must respond with a “\*” when a connection is made.

##### 10.4.3.1 Target Logical Unit Number Assignments

The following iSCSI target logical unit number (LUN) assignments shall be used.

- a. The LUN 0 or 32 shall be used for recorder data download via Section [10.5](#) interface.
- b. The LUN 1 or 33 shall be used for recorder CCM IAW the requirements for the optional iSCSI recorder control defined within Section [10.7](#).

<sup>3</sup> Institute of Electrical and Electronics Engineers. *IEEE Standard for a High Performance Serial Bus: Amendment 2*. IEEE 1394b-2002. New York: Institute of Electrical and Electronics Engineers, 2002.

<sup>4</sup> Internet Engineering Task Force. “Telnet Protocol Specification.” RFC 854. May 1983. Updated by RFC 5198. Retrieved 17 May 2021. Available at <http://tools.ietf.org/html/rfc854>.

<sup>5</sup> Internet Engineering Task Force. “Telnet Option Specifications.” RFC 855. May 1983. May be superseded or amended by update. Retrieved 17 May 2021. Available at <http://datatracker.ietf.org/doc/rfc855/>.

<sup>6</sup> Internet Engineering Task Force. “Telnet Linemode Option.” D. Borman, ed. RFC 1184. October 1990. May be superseded or amended by update. Retrieved 17 May 2021. Available at <http://datatracker.ietf.org/doc/rfc1184/>.

#### 10.4.3.2 Naming and Addressing

The host ground system (initiator) and recorder (target) devices on the network must be named with a unique identifier and assigned an address for access. The iSCSI initiators and target nodes can either use an iSCSI qualified name (IQN) or an enterprise-unique identifier (EUI). Both types of identifiers confer names that are permanent and globally unique.

Each node has an address consisting of the IP address, the TCP port number, and either the IQN or EUI. The IP address can be assigned by using the same methods commonly employed on networks, such as Dynamic Host Control Protocol (DHCP) or manual configuration.

#### 10.4.3.3 Physical and Signaling

The interface shall allow control of vendor-unique recorder devices. The command protocol shall be IAW Subsection [10.4.1.2](#) and [Table 10-5](#).

#### 10.4.3.4 Recorder Communication

The fundamental method of communicating shall be IAW the iSCSI protocol. Packets sent and received shall be asynchronous transmissions.

### 10.5 Interface File Structure Definitions

The definitions in this paragraph are a subset of, and were adapted from Section 3 of STANAG 4575. This file structure was selected to facilitate host computing platform independence and commonality. By incorporating an independent file structure, backward and forward compatibility is ensured for the life of the standard.

 <p><b>NOTE</b></p>	<p>This section duplicates text from STANAG 4575. Any definition in this standard that varies from the STANAG 4575 text is noted in a NOTE box. The text in a NOTE box takes precedence over the text from STANAG 4575.</p>
--	---

 <p><b>NOTE</b></p>	<p>This file structure definition does not define how data is physically stored on the recorder media but provides a standardized method for access of the stored data at the interface. Data can be organized in any way appropriate to the media, including multiple directories, as long as the file structure IAW Section <a href="#">10.5</a> is maintained or seen at the interface (Section <a href="#">10.4</a>).</p>
--	---

#### 10.5.1 Data Organization

A data recording can contain a single file, which is composed of one or more types of packetized data, or multiple files, in which one or more types of data are recorded simultaneously in separate files. For a recording file to be IAW this standard, it must contain as a minimum the following.

- a. Computer-Generated Packet(s), Format 1 setup record IAW [Chapter 11](#) Subsection 11.2.7.2 as the first packets in the recording
- b. Time data packet(s) IAW [Chapter 11](#) Subsection 11.2.3 as the first dynamic packet after the computer-generated packet, setup record
- c. One or more data format packets IAW Section [10.6](#)

Multiple recordings may reside on the media, and each recording may contain one or more compliant files.

The data hierarchy used to define the data stored according to this standard shall have the following structural relationships (highest to lowest). See [Figure 10-9](#).

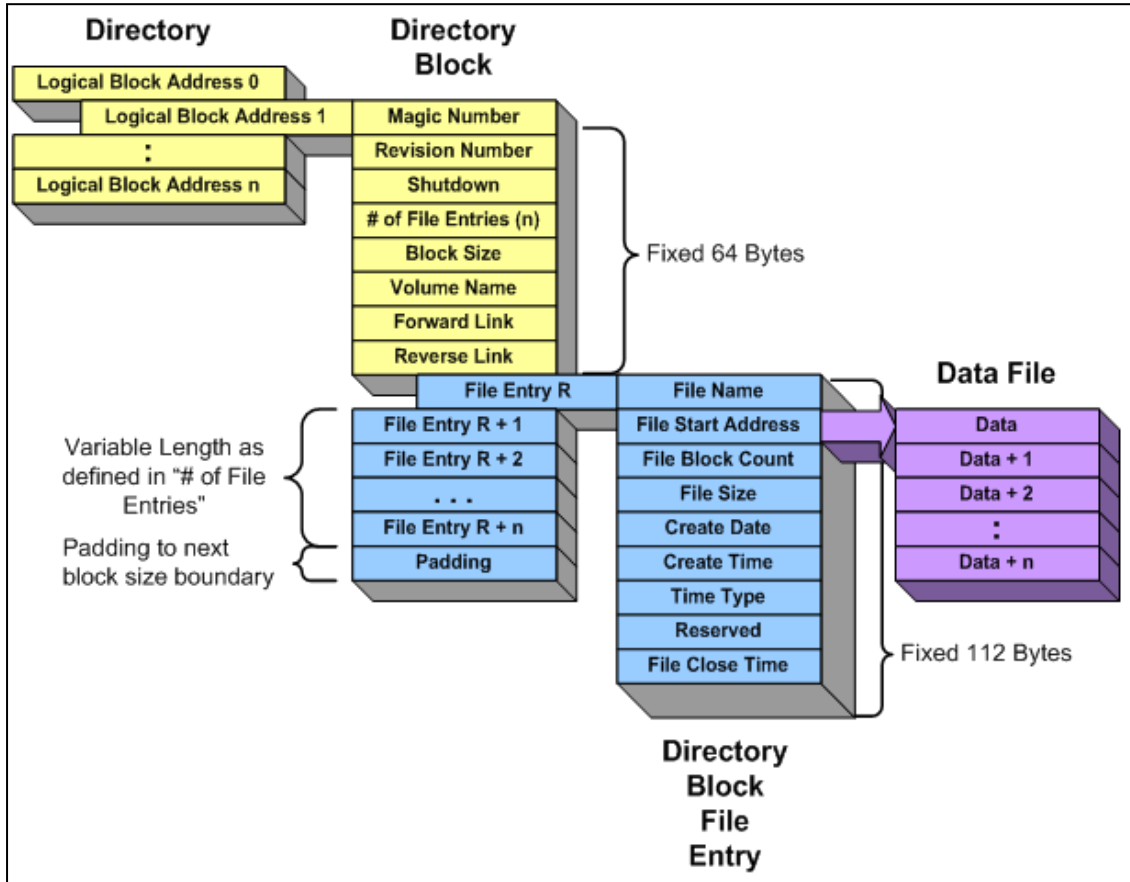

Figure 10-9. Directory Structure

- Directory.** One or more directory blocks of data comprising a list of all data files located under the guidance of this standard. Also contains supporting data that may be of interest to those manipulating the data files. The list of files is made up from “File Entries.” The directory shall always start at logical address zero of each directory block.
- Directory Block.** A memory block containing file entries and other metadata.
- Directory Block File Entry.** A fixed-length data structure used to describe files. It contains the name, the starting address, the number of blocks of data assigned to the data file, the total number of bytes contained in the file, and the file’s creation date and time. It also contains a reserved field for future growth and file close time.
- Data Files.** Data files are comprised of user data, presented at the interface in monotonically increasing contiguous logical addresses per file. Thus if a file starts at logical address X, the next location containing file data must be at the next logical address, X+1, and the next location after that must be at the next logical address, X+2, etc.



10.5.2 Directory Definition

The name and location information for all files recorded in a directory is illustrated in [Figure 10-9](#). The directory is composed of one or more directory blocks as shown in [Figure 10-10](#). At least one directory block is required and it must be located at SCSI logical block address 1. Logical block address 0 is reserved.

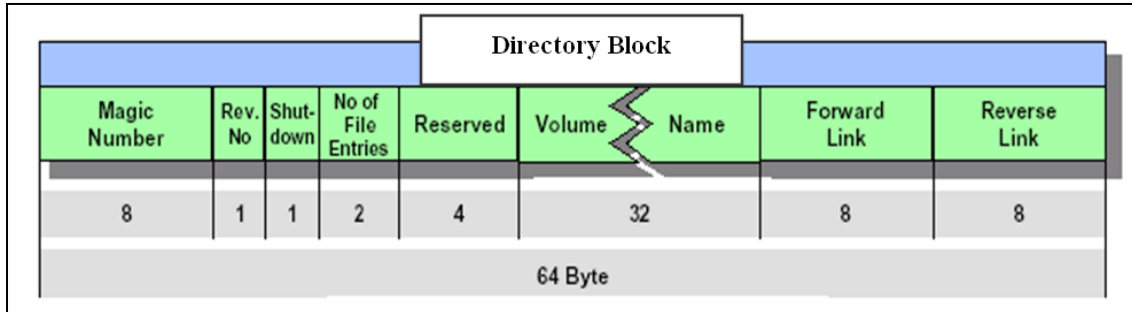

Figure 10-10. Directory Block

- a. Directory Fixed Fields. The fixed fields within a directory block are used to name the volume of data, identify the number of entries, and provide pointers to other addresses that contain additional directory blocks. Forward and backward links to the next address for the next directory block (if any) or the preceding directory block (if any) allow for directory expansion beyond a single block. This does not limit the placement of directory information.
- b. Block Size. The media types used to implement this standard have varying block lengths. Some will have blocks as small as 512 bytes; others may have blocks as large as 64 kb or larger. The block size used by a given media can be determined via the SCSI Read Capacity command (not defined here).
- c. Directory to Data File Link. Each data file on the media has a directory entry within a directory block that describes the file, as shown in [Table 10-6](#). The directory entry for a data file, as shown in [Table 10-7](#), contains a link to the starting location of the data contained in each file and the total number of blocks assigned for the storage of data. This standard does not define the meaning of the data recorded within these data file blocks.

Table 10-6. Directory Block Format			
Field Name	Bytes	Description	Data Type
Magic Number	8	An identifier for a directory block. This identifier supports discovery of lost directory entries and directory reconstruction after a fault. The value is BCS “FORTYtwo” (0x464F52545974776F)	BCS
Revision Number	1	Revision number of the standard compiled by the recording system. 0x01 = RCC 106-03 through RCC 106-05 0x0F = RCC 106-07 or later	Unsigned Binary

**Table 10-6. Directory Block Format**

Field Name	Bytes	Description	Data Type
Shutdown	1	Flag, if cleared to a 0x00, indicates that the volume was not properly dismounted, and if seen on power-up is an indication that the directory chain may be faulty. If set = 0xFF, then the file system properly shutdown. This field is only valid in the first directory located in logical block 1; other directory blocks set to 0xFF.	Unsigned Binary
Number of File Entries	2	Defines the number of file entries that follow in this block.	Unsigned Binary
Block Size	4	Bytes per block size referenced in FileBlkCnt in <a href="#">Table 10-7</a> .	Unsigned Binary
VolName	32	Volume name, see character set for restrictions. (Fill any unused VolName byte positions with 0x00.)	BCS
Forward Link	8	Block address of the next block containing directory information. Set equal to address of this block if this is the end of the chain.	Unsigned Binary
Reverse Link	8	Block address of the directory block pointing to this block. Set equal to this block address if this is the start of the chain.	Unsigned Binary
( <i>n</i> File Entries)	112 * <i>n</i>	One entry for each file specified in “Number of File Entries.” The maximum value of <i>n</i> is dependent upon media block size.	See <a href="#">Table 10-7</a>
Unused	Varies with <i>n</i> & block size	It is possible for bytes to remain between the last byte of the last-used file entry and the end of the directory block. These bytes are defined as unused and should be filled with 0xFF.	Unsigned Binary

Note: 64 bytes in fixed fields.

**Table 10-7. Data File Entry Format**

Field Name	Bytes	Description	Data Type
Name	56	File name (see character set for restrictions). Fill any unused File Name byte positions with 0x00.	BCS
FileStartAdd	8	Zero-based address of the first block reserved for data associated with this file. Fill with 0xFF for unused directory entries.	Unsigned Binary
FileBlkCnt	8	One-based number that is the count of consecutive address blocks reserved for data for this file including the block pointed to by the FileStartAdd field.	Unsigned Binary
FileSize	8	The actual number of bytes contained in this file. This file size will be equal to or less than the FileBlkCnt multiplied by the block size. This is an optional entry and will be filled with 0xFF if not used.	Unsigned Binary

**Table 10-7. Data File Entry Format**

Field Name	Bytes	Description	Data Type
File Create Date	8	DDMMYYYY BCS character values, with no embedded spaces or other formatting characters, representing the numeric date on which the file was created (e.g., BCS codes for the decimal digits 02092000 → 0x3032303932303030 represents 2 September 2000). Fill with 0x2D if a value for the field is not available, or for portions of the field where data is not available.	BCS
File Create Time	8	HHMMSSss character values, with no embedded spaces or other formatting characters, representing the numeric time at which the file was created. HH is the number of hours in a 24-hour-based day, MM is the number of minutes after the hour, SS is the number of seconds after the minute, and ss is the hundredths of seconds after the second. Fill with 0x2D if a value for the field is not available, or for portions of the field where data is not available (e.g., “ss” is not available).	BCS
Time Type	1	A numeric code that qualifies the time and date values recorded in the “Create Date” and “Create Time” and “Close Time” fields. 0x0 = Universal Coordinated Time (Zulu) 0x1 = System Time 0x2 - 0xFE = Reserved 0xFF = Time data packet	Unsigned Binary
Reserved	7	Bytes in this region are reserved for future growth. Fill with 0xFF.	Unsigned Binary
File Close Time	8	HHMMSSss character values, with no embedded spaces or other formatting characters, representing the numeric time at which the file was closed. HH is the number of hours in a 24-hour-based day, MM is the number of minutes after the hour, SS is the number of seconds after the minute, and ss is the hundredths of seconds after the second. Fill with 0x2D if a value for the field is not available, or for portions of the field where data is not available (e.g., “ss” is not available).	BCS

Note: 112 bytes in fixed fields.

- d. File Entry Name. Each file entry in a directory shall have a unique name (see Subsection [10.5.3.4](#)). Default file name is a BCS numeric value incrementally increasing, starting at value “1.”
- e. File Entry Singularity. Multiple file entries are not permitted to refer to the same regions of memory, partially or completely.

- f. Directory Entries and Fields. Directory block fields and entries shall be logically contiguous.
- g. Directory and Memory Region Relationships. File entries shall be entered sequentially into a directory block as files are recorded, starting with file entry #1 in the primary directory block (logical address 1). All file entry positions in the primary directory block shall be filled before the first secondary directory block is used, and so on; however, there is no a priori relationship between the memory region associated with a file entry and the place-order of the file entry within the overall directory. For example, the very first file entry could refer to the very last logical address region of memory, the second file entry could refer to the beginning logical address of memory, and so on. Similarly, there is no presumed temporal ordering of file entries; the very last entry to be inserted could be inserted in such a fashion so as to be the first entry encountered when traversing the directory chain of blocks.
- h. Empty Memory Reads. Reads of regions of memory not containing directory blocks or data file blocks may return unpredictable data values or result in other error conditions.
- i. Contiguous Directory Entries. File entries and all fields in a directory block are contiguous.

 <p><b>NOTE</b></p>	<p>Deleted files are not applicable to Chapter 10 as there are no recorder commands that allow or provide file deletion.</p>
--	--

- j. Deleted Files. In some applications, previously recorded files may be deleted in order to recover media space for new recordings. Deleted files shall be denoted by marking the corresponding file entry's file block count field with 0x00 indicating "unused." If the file block count has been set to 0x00, then other fields in that file entry are no longer meaningful.
- k. Reserved Field. Reserved fields shall not be used in Chapter 10 implementations and shall be filled with 0xFF. Reserved fields are intended for future Chapter 10 use.
- l. Number of File Entries. The numerical value placed in the "Number of File Entries" field of a directory block shall equal the number of active file entries plus any file entries marked as deleted files within that directory block.

### 10.5.3 Data Definitions

#### 10.5.3.1 Directory Byte Order

The directory structures described in Section [10.5](#) of this standard are defined to have the following bit and byte orientation. The most significant byte of any multi-byte structure is byte 0. The msb of each byte is bit 0. This ordering is commonly referred to as "Big Endian."

#### 10.5.3.2 Data Format Byte Order

The data format structures (Packet Header, etc.) are defined by [Chapter 11](#) to have the following bit and byte orientation. The least significant byte shall be transmitted first, the lsb of each byte shall be transmitted first, and data is read from the lowest logical address first. This

ordering is commonly referred to as “Little Endian.” The packet data remains in its native byte order format.

### 10.5.3.3 Character Set

The character set for all character fields is based on ISO/IEC 10646:2012.<sup>7</sup> The NATO Imagery Interoperability Architecture limits characters to a subset rather than allowing all characters. The subset will be single octets, known as the BCS.

### 10.5.3.4 Naming Restrictions

The following rules shall be applied when forming names in order to assure the highest degree of interchange among other operating systems.

- a. **Characters.** Characters from the first 127 common BCS characters (0x00 through 0x7E) may be used in names except for specific prohibited characters.
  - (1) Any BCS character code value smaller than 0x20 is prohibited, except where the 0x00 is used to terminate the name.
  - (2) The other prohibited characters with their hexadecimal representation are defined in [Table 10-8](#).

<b>Forbidden Characters in Names</b>	<b>Hexadecimal Value</b>	<b>Forbidden Characters in Names</b>	<b>Hexadecimal Value</b>
“	0x22	=	0x3D
‘	0x27	>	0x3E
*	0x2A	?	0x3F
/	0x2F	\	0x5C
:	0x3A	]	0x5D
;	0x3B	[	0x5B
<	0x3C		0x7C

- b. **Names.** Names used for this interface will observe the following rules.
  - (1) Upper and lowercase characters are considered to be different within file names.
  - (2) Leading and trailing spaces are not permitted.
  - (3) Leading periods are not permitted.
  - (4) Names shall fill their field starting with byte 0 per Subsection [10.5.3.1](#) and be terminated with a 0x00. Unused name characters shall be filled with 0x00. Names may utilize the full length of the field, in which case the terminating 0x00 must be omitted. Examples of host-provided and default file names are shown in [Figure 10-11](#).

<sup>7</sup> ISO/IEC. *Information Technology - Universal Coded Character Set (UCS)*. ISO/IEC 10646:2012. May 2012. Superseded by ISO/IEC 10646:2017. Superseding document retrieved 17 May 2021. Available at <http://standards.iso.org/ittf/PubliclyAvailableStandards/index.html>.

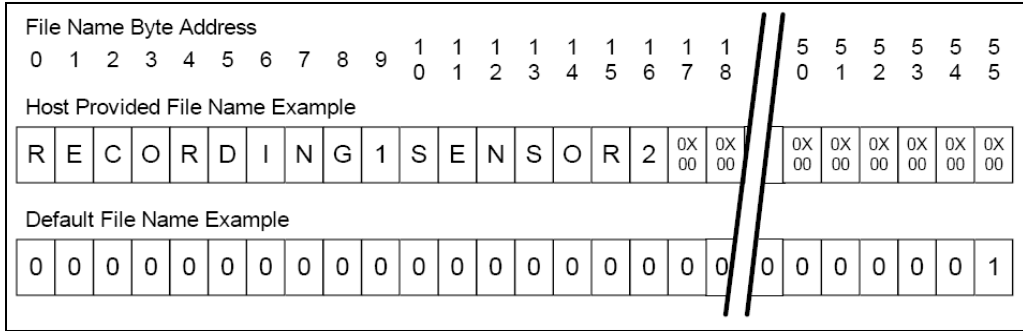

Figure 10-11. File Name Examples

**10.6 Data Format Definition**

**10.6.1 IRIG 106 Chapter 11**

Data shall be formatted IAW [Chapter 11](#).

Single or multiple channel recordings will always conform to the structure outlined in [Figure 10-12](#); note that the details of the packet structure are defined by [Chapter 11](#) and are included here for information only.

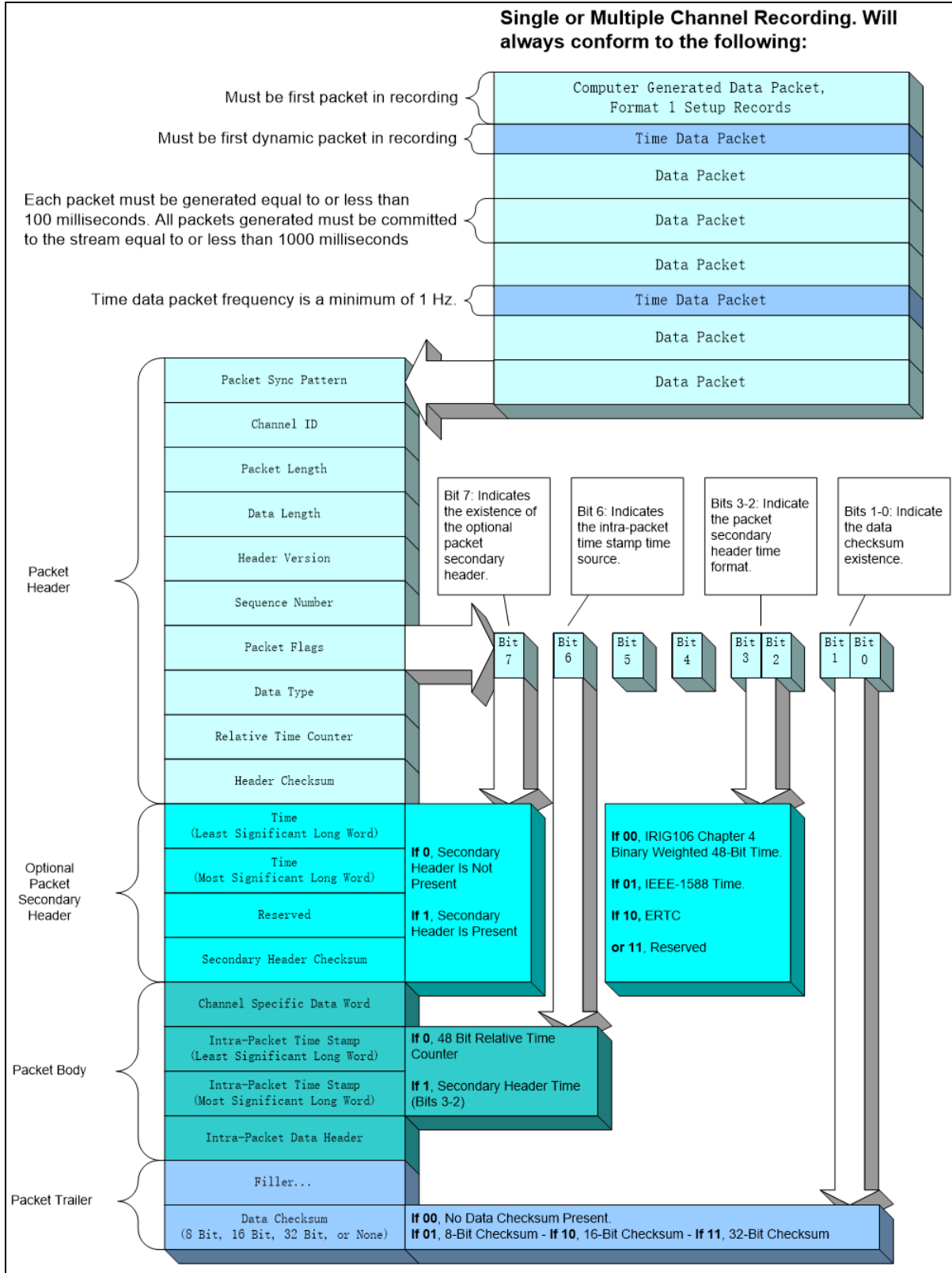

Figure 10-12. Data Recording Structure

- a. Certain packets are required by this standard, and areas shown in [Table 10-9](#).

**Table 10-9. Required Packets and Locations**

<b>Packet Type</b>	<b>Required</b>	<b>Required Packet Location</b>
Computer-Generated Data Packet, Format 1 Setup Record	Yes	First packets in recording. A single setup record may span across multiple Computer-Generated Data Packet, Format 1 setup records.
Time Data Packet	Yes	First dynamic data packet following setup record packet(s). Refer to the time data packet description for packet rate.
All other data type packets with the exception of Computer-Generated Data Packet, Format 1 setup record, time data packets, and Computer-Generated Data Packet, Format 3 recording index (root index)	No	After first time data packet and before the last Computer-Generated Data Packet Format 3, recording index (root index) if enabled.
Computer-Generated Data Packet, Format 3 recording index (root index)	Yes, if recording events are enabled. No, if recording events are disabled.	If recording index packets are enabled, root index packet type will be the last packet in a recording.

- b. With the exception of computer-generated packets, all other packet generation times shall be equal to or less than 100 milliseconds (ms) as measured by the 10-megahertz (MHz) relative time counter (RTC) whenever data is available. This requirement ensures that a packet shall contain equal to or less than 100 ms worth of data, and that a packet containing any data must be generated equal to or less than 100 ms from the time the first data was placed in the packet. This strategy will assure packet granularity and save bandwidth by not forcing or marking empty/idle packets.
- c. With the exception of computer-generated data packets, all other packets shall have a stream commit time equal to or less than 1000 ms as measured by the 10-MHz RTC contained in the packet header.

#### 10.6.2 Time Data Packets

Time is treated like another data channel. If a time source other than None is used (see [Chapter 11](#), Section 11.2.3), the time packet shall be generated at a minimum frequency of 1 hertz.

A time data packet shall be the first dynamic data packet at the start of each recording. Only static Computer-Generated Data, Format 1 packets may precede the first time data packet in the recording. If the time data packet source is “None”, at least one time data packet is required IAW the previous sentence.



## 10.7 Recorder Control

The recorder shall be controlled by either discrete control/status lines and/or serial communication ports. The serial interface shall consist of both RS-232 and RS-422 full duplex serial communications.

### 10.7.1 Recorder Control and Status

The RS-232 and RS-422 serial communication ports shall be functional simultaneously without requiring selection of either port. Status requested by either port shall be returned on both ports. Note that unexpected results may occur if commands are issued on both ports simultaneously.

#### 10.7.1.1 Mandatory Recorder Control

The recorder shall provide control by either serial communications ports supporting a command line interface (CLI) IAW [Chapter 6](#) Subsection 6.2 and/or discrete control/status lines IAW Subsection 6.4.

#### 10.7.1.2 Optional Recorder Control

The recorder may be controlled over the Fibre Channel, IEEE 1394b, or Ethernet recorder download interface ports from Section [10.4](#). These interfaces shall support communications using SCSI (Fibre Channel) IAW Subsection [10.4.1](#), SCSI over SBP-2 (IEEE 1394b) IAW Subsection [10.4.2](#), or iSCSI (Ethernet) IAW Subsection [10.4.3](#). Recorder login and Chapter 6 CCM shall be transmitted and received using the SCSI ORB structures IAW subsections [10.9.3](#) (as required for IEEE 1394b), [10.9.4](#), and [10.9.12](#).

#### 10.7.1.3 Optional Telnet Control

The recorder may be controlled over Ethernet/Telnet utilizing CLI as defined in [Chapter 6](#).

### 10.7.2 Communication Ports

The RS-232 and RS-422 serial communication ports shall be functional simultaneously without requiring selection of either port. Status requested by either port shall be returned on both ports. Note that unexpected results may occur if commands are issued on both ports simultaneously.

### 10.7.3 RS-232/422 Port

An RS-232/422 port shall be available at the download port.

### 10.7.4 Commands

Commands received through the serial communication ports shall not override hardware discrete controls.

### 10.7.5 Status Requests

Status requests received through the serial communication ports shall not interfere with hardware controls.

### 10.7.6 Serial Status

Serial status shall be provided on either serial status request or discrete activation.

### 10.7.7 Default Interface

Default interface with user equipment shall utilize the following ASCII serial communication protocol.

- a. 38400 baud
- b. One start bit
- c. 8-bit data
- d. No parity
- e. One stop bit

### 10.7.8 Serial Commands

The serial ports shall implement a CLI as described in [Chapter 6](#).

### 10.7.9 Required Discrete Control Functions

Discrete control functions and associated status are described in [Chapter 6](#), Subsection 6.4.

## 10.8 **Declassification**

As of IRIG 106-17 this section was moved to [Appendix 10-B](#).

## 10.9 **Host Platform Interface to Recorder Media**

Two interfaces, IEEE 1394b and IEEE 802.3 “Ethernet”, are defined to provide a communication path to read and/or download data from an RMM and to write an RSCF to an RMM. The selection of these protocols was adopted to facilitate a common interface between the media and the computing platform. It is anticipated that any particular RMM will support only one of the two host platform interfaces.

 <b>NOTE</b>	This definition does not mandate the interface between the recorder and media.
---	--

### 10.9.1 Media Time Synchronization

In order to allow recorders to be synchronized to the same time without requiring platform modification or an external time source being provided to the recorder, the removable media cartridges can optionally maintain time, allowing for time initialization of the recorder. Removable media cartridges can optionally provide a battery back-up real-time clock device. Initialization of time can optionally be accomplished via the host platform interface.

### 10.9.2 Physical and Signaling

Each host platform interface has distinct requirements for the physical interface and signaling levels.

#### 10.9.2.1 IEEE 1394b Interface

The IEEE 1394b host platform interface shall provide data communications and power using the same connector IAW IEEE 1394b.

### 10.9.2.2 Ethernet Interface

The Ethernet host platform interface shall be IAW the IEEE 802.3 standards. Only a subset of the physical interfaces defined by IEEE 802.3 shall be employed. A power input accepting 8-30 volts direct current and drawing a current of not to exceed 5 amps shall be provided. Additionally, Power Over Ethernet (PoE) IAW IEEE 802.3at-2009<sup>8</sup> may be used to deliver power to the RMM.

- a. 100Base-TX. For data rates of up to 100 megabits per second (Mbps), 100Base-TX signaling IAW IEEE 802.3 shall be employed.
- b. 1000Base-T. For data rates in excess of 100 Mbps but less than 1000 Mbps, 1000Base-T with auto negotiation to lower speeds as defined in Paragraph a above shall be employed IAW IEEE 802.3.
- c. 10G-Base-T. For data rates in excess of 1000 Mbps, 10GBase-T with auto negotiation to lower speeds as defined in item b above shall be employed IAW IEEE 802.3.

### 10.9.3 Removable Media Communication

Logically, each compliant RMM shall contain two distinct functional entities as per [Figure 10-13](#). The mechanisms used to communicate with the two functional entities vary according to the host platform interface type.

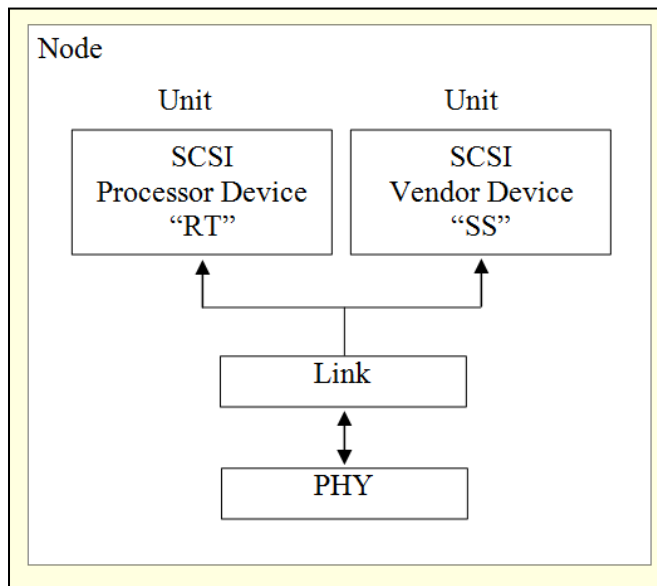



Figure 10-13. Removable Media

#### 10.9.3.1 IEEE 1394b Host Platform Interface

The fundamental method of communicating shall be IAW the IEEE 1394b protocol. Packets sent and received shall be asynchronous transmissions. The IEEE 1394b packets shall

<sup>8</sup> Institute of Electrical and Electronics Engineers. *IEEE Standard for Information technology - Telecommunications and information exchange between systems...Amendment 3: Data Terminal Equipment (DTE) Power via the Media Dependent Interface (MDI) Enhancements*. IEEE 802.3at-2009. October 2009. Superseded by update. Superseded document retrieved 17 May 2021. Available with registration at <http://standards.ieee.org/findstds/standard/802.3at-2009.html>.

encapsulate SBP-2-formatted packets for the transport of commands and data. Removable media devices are to use SCSI command set(s) and therefore SCSI commands and status shall be encapsulated in SBP-2 ORBs.

	<p>SBP-2 provides for the transport of 6-, 10-, and 12-byte SCSI CDBs within a command ORB.</p>
---	---

10.9.3.2 IEEE 802.3 Ethernet Host Platform Interface

The fundamental method of communicating shall be IAW the IPv4 protocol defined by IETF RFC 791<sup>9</sup> and subsequent related documents.

- a. MTU (Frame size). Following power on or reset, the RMM shall select an MTU of 1500 bytes.
- b. RMM IP Addressing. Each RMM should attempt to obtain an IP addressing using DHCP IAW IETF RFC 2131<sup>10</sup> with the options as described below. In the event no IP address can be obtained via DHCP, the RMM shall use a static IP. By default, the static IP address shall be set to 10.9.3.2, with a net mask of 255.0.0.0, and a default gateway of 10.9.3.1. The default static IP can be changed by sending a .RMMIP IP address command as defined in [Chapter 6](#) Subsection 6.5.6.3.

When using DHCP to obtain an IP address, the RMM shall send a DHCP vendor class identifier option (code 60) IAW IETF RFC 2131 to the server, and the first 10 characters of the data string sent with the vendor class identifier option shall be the text “RMM:CH10:”, optionally followed by information further identifying the type of RMM.

- c. RMM Discovery. The RMM shall implement a service location protocol (SLP) service agent IAW IETF RFC 2608<sup>11</sup> and [Table 10-10](#). The ground station may implement an SLP user agent or any other suitable method (e.g., tight integration with the DHCP server) to determine the IP address assigned to an RMM. The RMM may provide a set of service attributes IAW [Table 10-10](#). The SLP authentication blocks shall not be required.

<b>Table 10-10. Ethernet Service Location Protocol Characteristics</b>			
Characteristic	Provision	Type	Value
Service Name	Required	String	service:RMM:IRIG 106:
Service Location	Required	String	//nnn.nnn.nnn.nnn[:pppp]representing the IP address of the RMM and optionally the port number (pppp) on which the Telnet service will respond if not port 923 (see Subsection <a href="#">10.9.4.2</a> )

<sup>9</sup> Internet Engineering Task Force. “Internet Protocol.” RFC 791. September 1981. Updated by RFC 1349, RFC 6864, and RFC 2474. Retrieved 17 May 2021. Available at <http://datatracker.ietf.org/doc/rfc791/>.

<sup>10</sup> Internet Engineering Task Force. “Dynamic Host Configuration Protocol.” RFC 2131. March 1997. Updated by RFC 5494, RFC 4361, RFC 6842, and RFC 3396. Retrieved 17 May 2021. Available at <http://datatracker.ietf.org/doc/rfc2131/>.

<sup>11</sup> Internet Engineering Task Force. “Service Location Protocol, Version 2.” RFC 2608. June 1999. Updated by RFC 3224. Retrieved 17 May 2021. Available at <http://datatracker.ietf.org/doc/rfc2608/>.

<b>Table 10-10. Ethernet Service Location Protocol Characteristics</b>			
<b>Characteristic</b>	<b>Provision</b>	<b>Type</b>	<b>Value</b>
Naming Authority	Optional	String	RCC. If used, the service name shall be service:RMM.RCC:IRIG 106:
<b>Attributes</b>			
Product	Optional	String	Identification of manufacturer, vendor, and/or part number of the RMM
SerialNo	Optional	String	Identification of the unique RMM
Capacity	Optional	Integer	Size of the RMM in gigabytes, rounded up.
Note: If present, the product string, serial number, and capacity attributes shall be used solely to identify a particular RMM, and shall not be used to modify the behavior of the ground system.			

- d. Ping Response. The RMM shall respond to an internet control message protocol echo request IAW RFC 792.<sup>12</sup>
- e. Accessing RMM Storage. In addition to the mandatory control interface via Telnet, the RMM bulk storage device shall support at least one of the following two methods of accessing data, and may support both:
  - (1) iSCSI. To facilitate random access, the iSCSI protocol IAW IETF RFC 3270<sup>13</sup> and the companion RFC 5048<sup>14</sup> may be implemented according to Subsection [10.9.3.3](#).
  - (2) File Transfer Protocol. To facilitate efficient downloading with low overhead, the file transfer protocol (FTP) IAW IETF RFC 959<sup>15</sup> with optional extensions IAW RFC 3659<sup>16</sup> may be implemented according to Subsection [10.9.3.4](#).

### 10.9.3.3 iSCSI Data Access Method

The RMM shall act as an iSCSI target and a host computing platform shall act as the iSCSI initiator. The RMM shall implement the commands defined by Subsection [10.9.11](#) when sent using iSCSI CDBs.

#### 10.9.3.3.1 iSCSI Session Establishment

The RMM shall support iSCSI features described in this section, sufficient to establish an iSCSI full-feature phase between the ground system and the RMM.

<sup>12</sup> Internet Engineering Task Force. "Internet Control Message Protocol." RFC 792. September 1981. Updated by RFC 950, RFC 4884, RFC 6633, RFC 6918. Retrieved 17 May 2021. Available at <http://datatracker.ietf.org/doc/rfc792/>.

<sup>13</sup> Internet Engineering Task Force. "Multi-Protocol Label Switching (MPLS) Support of Differentiated Services." RFC 3270. May 2002. Updated by RFC 5462. Retrieved 17 May 2021. Available at <http://datatracker.ietf.org/doc/rfc3270/>.

<sup>14</sup> Internet Engineering Task Force. "Internet Small Computer System Interface (iSCSI) Corrections and Clarifications." RFC 5048. October 2007. Updated by RFC 7146, obsoleted by RFC 7143. Retrieved 17 May 2021. Available at <http://datatracker.ietf.org/doc/rfc5048/>.

<sup>15</sup> Internet Engineering Task Force. "File Transfer Protocol (FTP)." RFC 959. October 1985. Updated by RFC 7151, RFC 5797, RFC 2773, RFC 2228, RFC 2640, RFC 3659. Retrieved 17 May 2021. Available at <http://datatracker.ietf.org/doc/rfc959/>.

<sup>16</sup> Internet Engineering Task Force. "Extensions to FTP." RFC 3659. March 2007. May be superseded or amended by update. Retrieved 17 May 2021. Available at <http://datatracker.ietf.org/doc/rfc3659/>.

- a. IPsec. IPsec shall not be used.
- b. Login Security. The ground system shall invoke the iSCSI login phase with the *LoginOperationalNegotiation* stage. The *SecurityNegotiation* stage shall not be used.
- c. Target Naming. When an iSCSI target name is required, e.g., as a result of a SendTargets exchange, the RMM shall provide exactly one IQN per supported target. The name shall take the form:

iqn.yyyy-10.org.tsc: RMM:CH10.vvvvvvvv-sssss

Where yyyy is the year corresponding to the applicable version of this standard and vvvvvvvv-sssss is a pair of arbitrary length strings separated with a “-” that identify the manufacturer/vendor and part identifier of the type of RMM and the serial number or other unique identifier of that particular RMM. These strings shall not contain a colon (“:”) symbol.

 <p><b>NOTE</b></p>	<p>An RMM may support multiple targets. The name format described above shall not be used for any target that does not adhere to this standard, e.g., for non-compliant storage areas.</p>
--	--

- d. Header and Data Digests. Error detection digests shall not be required, but may be supported.
- e. Redirection. The RMM shall not employ redirection via the TargetAddress and TargetPortalGroupTag keys.
- f. Burst and Segment Lengths. The RMM and the ground station shall support the default values per RFC 3720.<sup>17</sup>
- g. Other Keys. For features to be negotiated during the login phase not otherwise specified, the RMM and the ground station shall support the default values per RFC 3720.

#### 10.9.3.4 FTP Data Access Method

The RMM shall implement an FTP server, and shall support image (aka binary) data representation and passive mode. Unless changed by means of the .TCPPOPTS command, the RMM shall employ TCP port 921. By default, the RMM shall accept a login username of “IRIG:CH10” with the associated password “RMM:FTP”. The RMM may also support anonymous FTP. If so the RMM shall provide a mechanism to disable this feature.

The RMM FTP server shall respond with an error code 550 and take no action in response to the DELE, MKD, RMD, RNFR, and RNTD commands.

#### 10.9.4 RMM High-Level Command Handling

Removable devices shall implement high-level Chapter 6 commands in addition to the data transport commands. These high-level commands and the associated responses shall be transported to the RMM depending on the host platform interface in use.

---

<sup>17</sup> Internet Engineering Task Force. “Internet Small Computer Systems Interface (iSCSI).” RFC 3720. April 2004. Obsolete by RFC 7143. Retrieved 17 May 2021. Available at <http://datatracker.ietf.org/doc/rfc3720/>.

#### 10.9.4.1 High-Level Commands for IEEE 1394b Host Platform Interface

When using the IEEE 1394b interface, the SEND and RECEIVE processor device SCSI-2 commands shall be implemented. The Chapter 6 commands and data will be transported using these SCSI commands and the data buffers.

#### 10.9.4.2 High-Level Commands for Ethernet Host Platform Interface

When using the Ethernet interface, the RMM shall support a Telnet server IAW IETF RFC 854 using TCP port 923

#### 10.9.5 Mandated Connectors

Distinct from the recorder/RMM data interface, the removable media shall use the connector mandated for the host platform interface type.

##### 10.9.5.1 IEEE 1394b Interface Connector

The connector type for the removable media shall be an IEEE 1394b bilingual socket connector. Power for the removable media shall be derived from the bilingual interface connector.

##### 10.9.5.2 Ethernet Connector - Data

The connector type for the removable media data connection shall be an 8P8c, commonly known as RJ45, connector. Power may also be supplied using this connector by means of the POE mechanism.

##### 10.9.5.3 Ethernet Connector - Power

The connector type for power when using Ethernet shall be a socket that accepts a barrel plug with a 5.5-millimeter (mm) outside diameter, a 2.5-mm inside diameter, and a shaft length of 9.5 mm. The plug shall be wired center-positive, and the connector shall carry a current of at least 5 amps.

#### 10.9.6 Real-Time Clock

Removable media configured with a real-time clock can optionally allow for time to be preset in the media, allowing for the transfer to the recorder.

##### 10.9.6.1 Minimum Operational Requirements

If an optional real-time clock is implemented, its time setting accuracy shall be better than 1 ms. The short time accuracy of the real-time clock device must be at least 10 parts per million (ppm) in the temperature range 0-40°C, and at least 50 ppm in the temperature range -40°C - +85°C.

##### 10.9.6.2 Accessing time using the IEEE 1394b Host Platform Interface

The SCSI command set shall be utilized to access time on the cartridge.

- a. Real-Time Clock Time Format. If an optional real-time clock is implemented the time format shall be IAW [Chapter 6](#) Subsection 6.2.3.10. The date format shall be IAW ISO 8601:2004.<sup>18</sup>

---

<sup>18</sup> International Organization for Standardization. *Data elements and interchange formats--Information interchange--Representation of dates and times*. ISO 8601:2004. Geneva: International Organization for Standardization, 2004.

- b. Real-Time Clock Logical Unit Number. The standard SCSI media devices are using LUN = 0. The real-time clock shall be assigned LUN = 1.

#### 10.9.6.3 Accessing time using the Ethernet Host Platform Interface

If an optional real-time clock is implemented the cartridge time shall be accessed via the .TIME command including the precision time protocol extensions if supported.

#### 10.9.7 Mandatory Commands for RMM Devices

The required command set for RMM devices is defined by [Chapter 6](#), Section 6.5.

#### 10.9.8 Date and Time Setting Requirements

To support setting the time and date of the real-time clock, the RMM should follow the procedures defined by [Chapter 6](#), Subsection 6.5.2.

#### 10.9.9 Checking Battery Status

Verification of health of battery shall be accomplished with .CRITICAL and .HEALTH commands IAW [Chapter 6](#), Subsection 6.2.3.1 and Subsection 6.2.3.3.

#### 10.9.10 Declassification Supporting Commands

Commands to support sanitization for declassification or other purposes are described in [Chapter 6](#), Subsection 6.5.3.

#### 10.9.11 SCSI and iSCSI Devices

The mandatory SCSI command set is defined in [Chapter 6](#), Subsection 6.5.4.

#### 10.9.12 Using IEEE 1394b

The mandatory ORB formats and related command information is documented in [Chapter 6](#), Subsection 6.5.5.

#### 10.9.13 Using Ethernet

Additional mandatory commands required when using Ethernet are documented in [Chapter 6](#), Subsection 6.5.6.

 <p><b>NOTE</b></p>	<p>The RMMs using IEEE 1394b, SCSI or iSCSI shall support as a minimum the SCSI command set to support data download IAW Section <a href="#">10.4</a>.</p>
--	--

### 10.10 **Ground-Based Recorders**

This section specifies the basic requirements of ground-based recorders. The main functional requirements of ground-based recorders areas follows.

- a. Recorder Interface
- b. Recorder Data Format
- c. Recorder Media
- d. Recorder Command and Control (if the ground-based recorder is to be controlled remotely)



Optionally, ground-based recorders may support replay, reproduction, and display of Chapter 10 data recordings. Basic replay and reproduction interoperability requirements will be defined in this section. Data display requirements are outside the scope of this standard and will not be defined.

10.10.1 Interface

- a. At a minimum, the required ground-based recorder interface shall be Ethernet for remote command and control IAW Section [10.4](#) and Section [10.7](#).
- b. Optionally, ground-based recorders can implement additional interfaces for remote command and control, remote data access, and/or data streaming. If a ground-based recorder uses iSCSI or contains an RS-232/422, IEEE 1394, and/or Fibre Channel for these interfaces, it shall be IAW Section [10.4](#) and Section [10.7](#).
- c. Data streaming
  - The recorder can optionally have the capability to stream Chapter 10 format data (Subsection [10.10.2](#)) out of its required Ethernet interface IAW Subsection [10.3.9.1](#).
  - Stream commit time as defined in Subsection [10.6.1](#) item [c](#) shall apply to Ethernet interface data streaming.

10.10.2 Data Format

Ground-based recorders shall format, multiplex, and record all data IAW Section [10.6](#).

10.10.3 Recording Media

Ground-based recorders shall record data IAW Subsection [10.10.2](#) to COTS media. The term COTS is defined as any recording media (such as hard disks, solid-state drives, tape, Redundant Array of Independent Disks, and Just a Bunch of Disks) that is ready-made and available for sale to the general public.

The COTS media shall have an electrical interface (such as Parallel Advanced Technology Attachment, Serial Advanced Technology Attachment, IEEE 1394, Universal Serial Bus, SCSI, Ethernet) to the ground-based recorders that is ready-made and available for sale to the general public.

 <p><b>NOTE</b></p>	<p>If ground-based recorders use COTS media for recording of the Subsection <a href="#">10.10.2</a> data format, the recorded data remote data access at a minimum shall be across the required ground-based recorder Ethernet interface using iSCSI IAW Subsection <a href="#">10.4.3</a> and Section <a href="#">10.5</a>.</p>
--	--

 <p><b>NOTE</b></p>	<p>If ground-based recorders provide remote data access across the ground-based recorder Ethernet interface, the interface file structure described in Section <a href="#">10.5</a> at a minimum shall be presented at the interface. This does not dictate which COTS media format or data organization is implemented, but does require that the interface file structure is presented at the recorder Ethernet interface.</p>
--	--

All COTS media used by ground-based recorders shall provide the capability of recording valid Chapter 10 original recording file(s) IAW Section [10.11](#). All Section [10.11](#) data transfer and file management requirements shall apply to ground-based recorders.

#### 10.10.4 Remote Command and Control

- a. Optionally, if a ground-based recorder is controlled remotely, it shall provide command and control IAW Subsection [10.7.8](#) across the Ethernet interface port as defined in Subsection [10.10.1](#).
- b. Ground-based recorders at a minimum are required to use iSCSI or Telnet as the command and control Ethernet transport mechanism as defined in Section [10.4](#) and Section [10.7](#).
- c. Ground-based recorders providing remote command and control capability shall provide the functionality for all commands defined in Subsection [10.7.8](#).
- d. Optionally, if a ground-based recorder contains an RS-232/422/485, IEEE 1394b, and/or Fibre Channel interface as defined in Subsection [10.10.1](#) the recorder will provide command and control IAW Section [10.7](#) and [Chapter 6](#).

#### 10.10.5 Data Replay and Reproduction

##### 10.10.5.1 Channel Mapping

- a. Optionally, if a ground-based recorder provides data playback capability, it shall provide for the logical assignment of recorded channels to physical channels on the ground-based recorders.
- b. Playback will not require movement of cards between slots to make assignments for playback.

##### 10.10.5.2 Recording/Reproduction Data Rates

Optionally, if a ground-based recorder provides a data playback capability, it shall provide information using the [Chapter 6](#) .CRITICAL and .HEALTH commands (Subsection 6.2.3.1 and Subsection 6.2.3.3) if the bandwidth of data to be played back exceeds the aggregate bandwidth of the ground-based recorder.

##### 10.10.5.3 Network Recording Playback

- a. Optionally, if a ground-based recorder provides a data playback capability, it shall provide replay from COTS media (Subsection [10.10.3](#)) to the Ethernet interface. The Ethernet format of the network recording playback will be IAW Subsection [10.3.9](#).
- b. If the network recording playback capability is commanded remotely, ground-based recorders shall support the functionality specified in [Chapter 6](#).

### 10.11 **Data Interoperability**

#### 10.11.1 Original Recording Files

All files contained within a recorder, RMM, COTS media, or that are a byte-for-byte single file downloaded to a host computing platform in unaltered form shall be considered original recording files and be in full compliance with the data organization in Subsection [10.5.1](#) and data format in Section [10.6](#).

In order to provide a standardized method of annotation for original recording files, the following procedures shall be used to ensure Chapter 10 compliance:

- The Computer-Generated Data, Format 1 setup record shall always contain the required attributes IAW Section [10.11](#).
- The original recording file setup record R-x\RI3 “Original Tape/Storage” attribute value shall be R-x\RI3:Y;

#### 10.11.2 Modified Recording Files

Modified recording files are created from original recording files directly from a recorder, RMM, COTS media, or from original recording files that have been downloaded to a host computing platform. There are several instances of modified recording files-filtered or sanitized data, a subset of channels, a superset of channels, a subset of time, a subset of both channels and time, or a superset of channels and subset of time.

##### 10.11.2.1 Modified Recording File Annotation

In order to provide a standardized method of annotation for modified recording files, the following procedures shall be used to ensure Chapter 10 compliance.

- a. The Computer-Generated Data, Format 1 setup record shall always contain the required attributes IAW Section [10.11](#).
- b. Any time a modification is made to an original recording the R-x\RI3 Original Tape/Storage attribute value shall be changed:

From: R-x\RI3:Y;

To: R-x\RI3:N;

In addition, the R-x\RI6 Date of Modification attribute will be added if not already present, in which case if R-x\RI3 contains a “Y” R-x\RI6 shall be empty. The R-x\RI8 attribute value shall contain the last date and time the modified recording file was created.

- c. If the modified recording file is not a time subset but either a channel subset or both a time and channel subset, then the step b attributes shall be changed as defined. The original channels that are not included in the recording subset file shall have the R-x\CHE-n Channel Enable attribute changed:

From: R-x\CHE-n:T;

To: R-x\CHE-n:F;

A comment attribute R-x\COM will be inserted directly after the changed R-x\CHE-n attribute and shall contain the following:

“original recording change-removed channel-*n*” (where *n* represents the channel ID of the channel that was removed).

- d. If the modified recording file is not a time subset but either a channel superset or both a time subset and channel superset, then the step b attributes shall be changed as defined. In addition, the channels added in the modified recording file shall contain the required attribute IAW Section [10.11](#).

A comment attribute R-x\COM will be inserted directly after the added channel R-x\CHE-n attribute and shall contain the following:

“original recording change-additional channel-*n*” (where *n* represents the channel ID of the channel that was added).

If the modified recording file contains filtered (removed packets or data) or sanitized data (overwrite of data), then the step b attributes shall be changed as defined. Also the channels that contain filtered or sanitized data in the modified recording file shall also contain a comment attribute R-x\COM inserted directly after the channel R-x\CHE-*n* attribute and shall contain the following:

“original recording change-filtered channel-*n*” (where *n* represents the channel ID of the channel that was filtered).

#### 10.11.2.2 Modified Recording File Restructuring

When a modified recording file is created there will be alterations to original packets or possibly structure. Therefore:

- a. All files shall reflect any sequence number, packet length, or checksum changes in the appropriate packet header fields.
- b. If enabled in the original recording, Computer-Generated Data, Format 3 recording index packets shall be recalculated to ensure correct information is contained within the entries as they relate to the newly created modified recording file.

#### 10.11.3 Original Recording and Modified Recording File Extension

Upon data download to a host computing platform, all original and/or modified recording files shall use the file extension \*.ch10 (or \*.c10 extension for use on systems with a 3-character extension limit). The use of this standard extension will indicate that any original and/or modified recording file on a ground computing or storage platform shall be IAW this section.

#### 10.11.4 File Naming

Upon data download from the recorder or RMM to a host computing platform, all or modified recording files shall use the following structure and naming conventions unless the host computing platform operating system imposes naming length limits. In this case the directory and file names are to be truncated after the last component that completely fits within the name length limit.

##### 10.11.4.1 On-Board Recorder

- a. Data Recording Directory Name. Each directory block from an RMM to be downloaded to a ground computing or storage platform shall use VolName as defined in [Table 10-6](#) as the directory name where the data files will be placed. The directory name shall use lower-case letters.

If the VolName is empty (0x00), a default name or user-defined name shall be used. If used the default name shall be ch10dirnnn, where nnn is the sequential directory block count.

- b. Data File Name. Each data file contained within a directory block on the RMM to be downloaded will be placed in the directory identified in item a above and shall use the following naming convention. The data file name shall use lower-case letters.

“filennnn”; where nnnn is the sequential RMM file count from each directory block file entry (must be 8 alpha-numeric characters).

Example: “file0001,” “file0002,” ...: “file9999.”

If available, File Create Date, File Create Time, and File Close Time from [Table 10-7](#), DDMMYYYY\_HHMMSSss\_HHMMSSss (8 numeric characters for File Create Date, 8 numeric characters for File Create Time separated by an underscore ASCII character code 0x5F, and 8 numeric characters for File Close Time). No spaces or other non-numeric characters allowed.

Example: 02092004\_21302731\_21451505.

If the File Create Date, File Create Time, and File Close Time values are not available and are filled with 0x2D, then the system time from the host download platform will be used for File Create Date and File Create Time (DDMMYYYY\_HHMMSS). File Close Time will not be used. File Close Time shall be replaced with sys\_time.

A structure example follows:

...\VolName\FileName\_FileCreateDate\_FileCreateTime\_FileCloseTime

When VolName not empty example:

...\<VolName>\file0001\_02092004\_21302731\_21451505.ch10

When VolName empty default example:

...\ch10dir001\file0001\_02092004\_21302731\_21451505.ch10

When VolName empty user defined example:

...\<User Defined>\file0001\_02092004\_21302731\_21451505.ch10

When date/time not available (0x2D fill) example:

...\file0001\_02092004\_213027\_sys\_time.ch10

The use of this standard recording and file naming convention will indicate that any file on a ground computing or storage platform is IAW this standard.

#### 10.11.4.2 Ground-Based Recorder

- a. Recording Directory Name. Each directory where the data files will be placed shall use the naming convention \ch10dir\_DDMMYYYY\_nnn; where *n* is the sequential number of Chapter 10 recording directories created on the DDMMYYYY date. The directory name shall use lower-case letters.
- b. Recording File Name. Each data file contained within a directory shall use the following naming convention. The data file name shall use lower-case alpha characters.

“filennnn”; where nnnn is the sequential file count from each recording (must be 8 alpha-numeric characters)

Example: file0001, file0002, ...:file9999

File Create Date, File Create Time, and File Close Time shall use the following naming convention.

DDMMYYYY\_HHMMSSss\_HHMMSSss (8 numeric characters for File Create Date, 8 numeric characters for File Create Time separated by an underscore ASCII character code 0x5F, and 8 numeric characters for File Close Time). No spaces or other non-numeric characters allowed.

Example: 02092004\_21302731\_21451505.

A structure example follows.

...\ch10dir\_02092005\_001\file0001\_02092005\_21302731\_21451505.ch10

The use of this standard recording and file naming convention will indicate that any file on a ground computing or storage platform is IAW this standard.

#### 10.11.5 Data Transfer File

In order to ensure the highest degree of interoperability for transfer of Chapter 10 recorder or RMM contents or original or modified recording files between organizations, the data transfer file structure shall be used. Essentially, a data transfer file contains all the same information and data that a recorder or RMM would present at the interface albeit within a single binary structure on either tape or random access devices. The data transfer file could also contain original or modified recording files from multiple recordings or dates.

 <b>NOTE</b>	Original or modified recording files downloaded to a host computing platform and transferred as a single file shall follow Subsection <a href="#">10.11.1</a> and Subsection <a href="#">10.11.2</a> .
--	--

##### 10.11.5.1 Data Transfer File Structure Definition

The following describes data transfer file structure and media environments.

- a. Tape Devices. A data transfer file on tape devices is treated essentially the same as a recorder or RMM in that the directory structure and data contents are as defined and organized in this standard. The data transfer file is a single binary file containing a directory structure IAW Section [10.5](#) and a single or multiple Chapter 10 original recording files or modified recording files. Only one data transfer file will be contained on a tape device media. The tape block size shall be 32 kb.
  - Logical address 1 will contain a directory and file structure IAW Subsection [10.5.2](#).
  - The corresponding Chapter 10 original recording files or modified recording files will follow the directory structure in contiguous bytes until the end of the data transfer file. The beginning of each Chapter 10 original or modified recording file in the data transfer file will begin at the byte offset contained in each file entry table file Start Address value.
- b. Random Access Devices. A data transfer file on a random access device is treated essentially the same as a recorder RMM in that the directory structure and data contents are as defined and organized in this standard. The data transfer file is a single binary file containing a directory structure IAW Subsection [10.5.2](#) and a single or multiple Chapter 10 original or modified recording files. Multiple data transfer files can be contained on a random access device.

- The Subsection [10.5.2](#) directory structure within the data transfer file begins at byte 0 and runs contiguously until the last file entry paragraph. The next byte after the last file entry block shall be the first byte in the first data file.
- The corresponding Chapter 10 original or modified recording files will follow the directory structure in contiguous bytes until the end of the data transfer file. The beginning of each Chapter 10 original or modified recording file in the data transfer file will begin at the byte offset contained in each file entry table file Start Address value.

#### 10.11.5.2 Data Transfer File Extension

Upon creation, all Chapter 10-compliant data transfer files not on tape devices shall use the file extension \*.tf10 (or \*.t10 extension for use on systems with a 3 character extension limit). The use of this standard extension will indicate that any data transfer file on a host computing or storage platform shall be IAW Subsection [10.11.5](#)

#### 10.11.6 Recording Directory File

A recording directory file is a binary file that is a byte-for-byte copy of the RMM or recorder directory structure presented at the interface. This file should represent the contents of an RMM or recorder directory at the time of Chapter 10 data download. The bytes in this file contain the byte-for-byte contents of the RMM's directory blocks in the order the directory blocks are linked, using each block's forward link field.

##### 10.11.6.1 Recording Directory File Extension

Upon creation, all Chapter 10-compliant recording directory files shall use the file extension \*.df10 (or \*.d10 extension for use on systems with a three-character extension limit). The use of this standard extension will indicate that any recording directory file on a host computing or storage platform shall be IAW Subsection [10.11.6](#).

This page intentionally left blank.



## APPENDIX 10-A

### Definitions

The following are definitions that are used in this standard and are provided as a means of removing ambiguities within the standard.

**Absolute Time:** A hypothetical time that either runs at the same rate for all the observers in the universe or the rate of time each observer can be scaled to by multiplying the observer's rate by a constant.

**Block:** The smallest unit of addressable memory that can be written to, read from, and/or erased.

**Bad Block:** A block determined to be unreliable for storing user data.

**Bad Block Table:** A table of bad block entries for a memory board. The data stored in the entry identifies the chip and block number of the bad block. The table entry also contains a flag field. The flag field is used to determine the circumstance in which the bad block was detected. It also provides a flag indicating whether the corresponding bad block has previously been secure erased.

**Byte:** A contiguous set of 8 bits that are acted on as a unit.

**Channel-Specific Data Word:** A required word for each data type channel that has data-specific information.

**Data Streaming:** Streaming of current value data whether it is being recorded or not, and playback streaming of recorded data from a file. Data streaming sends the data to one or more destinations simultaneously (e.g., recording media, recorder data interfaces).

**Extended Relative Time Counter:** A 1-GHz extension to the existing 10-MHz RTC.

**Long Word:** A contiguous set of 32 bits that are acted on as a unit.

**Mandatory:** Defines a mandatory requirement of this standard for full compliance. Mandatory requirements as defined in this standard are based on the use of "shall".

**Memory Clear:** Rendering stored information unrecoverable unless special utility software or techniques are used.

**Memory Sanitization:** The removal of information from information system media such that data recovery using known techniques or analysis is prevented. Sanitizing includes the removal of data from the media and verification of the action. Properly sanitized media may be subsequently declassified upon observing the organization's respective verification and review procedures.

**Multiplexer:** The entity that includes all the inputs, control interfaces, and functionality required to properly record data.

**Non-volatile:** Memory media that retains data when power is removed.

**Packet:** Encapsulates a block of observational and ancillary application data to be recorded.

**Packet Generation:** The placing of observational and ancillary data into a packet.

**Page:** Storage unit within the flash memory. A page is the smallest storage unit that can be written.

**Playback:** See Replay

**Reconstruction:** The output of a recorder where the timing and data content of the output signal are identical to the timing and data content of the originally recorded signal. This is generally the case where the input signal is captured using digital sampling techniques. Also see Reproduction.

**Recorder:** Is used where a function or requirement shall apply to both an on-board recorder and a ground-based recorder.

**Recording:** Is defined as the time interval from first packet generated (which by mandatory requirements is a Computer-Generated Data Packet, Format 1) and committed to the recorder media to the last packet generated and committed to the recorder media. Packet generation time and stream commit time, as defined within the standard, apply.

**Removable Memory Module:** The element of the on-board recorder that contains the stored data.

**Replay:** The virtual reconstruction of a recorded signal. This virtually reconstructed signal exists for the purposes of display, presentation, extraction, or retransmission.

**Reproduction:** The output of a recorder where the electrical characteristics of the output signal are identical to the characteristics of the originally recorded signal. This is generally only achievable when the input signal is captured using analog recording techniques. Also see Reconstruction.

**Setup Record:** TMATS IAW [Chapter 9](#) annotated in the Computer-Generated Data, Format 0 packet.

**Stream:** All packets from all enabled channels (including computer-generated data) that are generated until the end of a recording.

**Stream Commit Time:** The time span in which all generated packets must be committed to a stream.

**Word:** A contiguous set of 16 bits acted on as a unit.

## APPENDIX 10-B

### Sanitization

Associated documents such as National Security Agency Manual 9-12,<sup>19</sup> DoD Directive 5200.28,<sup>20</sup> and DCID 6/3<sup>21</sup> historically covered sanitization guidelines/requirements. These documents focused on sanitization of standard disk and other conventional memory technologies. Sanitization is the determination by an authorized official that classified information no longer requires, in the interest of national security, any degree of protection against unauthorized disclosure. This standard provides for the minimum set of commands that *may be* utilized to allow for user sanitization of solid-state media residing in an RMM. The solid-state media may consist of COTS solid-state disks or a memory configuration unique to the manufacturer. There are several approaches for sanitization. The responsibility for ensuring that a proper sanitization process has been effectively implemented will reside ultimately with the user/customer/program manager.

#### B.1. Approach

The following approaches for sanitization are currently recommended. It is believed that the user is the most qualified to determine the sanitization procedures for any program situation. It is the user's responsibility to correctly apply the guidelines to the program in each location to optimize the cost/effect while providing appropriate protection for the data. The guidelines are planned to be available on the Internet at [Defense Link](#).

#### B.2. Algorithm

The algorithm to erase secure data is described below. During the secure erase procedure, all blocks of memory shall be processed. No block in memory shall be excluded from secure erase processing for any reason.

- a. First Erase. Every memory block on the board is erased. Any erase failures reported by memory chips will result in the corresponding chip/block being declared a bad block. In the event this bad block is not already in the corresponding board's bad block table, a new bad block entry will be appended onto the board's bad block table. Note that this new entry will not have the secure erase flag set.
- b. First Write (0x55). Every memory chip location is recorded with the pattern 0x55. As each location is written, the data is read back to guarantee that all bits were written to the expected pattern. Any write failures reported by the chips or any data errors will result in

---

<sup>19</sup> National Security Agency. "NSA/CSS Storage Device Declassification Manual." Manual 9-12. 15 December 2014. May be superseded by update. Retrieved 17 May 2021. Available at <https://www.nsa.gov/Portals/70/documents/resources/everyone/media-destruction/storage-device-declassification-manual.pdf>.

<sup>20</sup> Department of Defense. "Security Requirements for Automated Information Systems (AIs)." DoDD 5200.28. 21 March 1988. Canceled by DoDI 8500.01. Superseding document retrieved 17 May 2021. Available at [https://www.esd.whs.mil/Portals/54/Documents/DD/issuances/dodi/850001\\_2014.pdf](https://www.esd.whs.mil/Portals/54/Documents/DD/issuances/dodi/850001_2014.pdf).

<sup>21</sup> Director of Central Intelligence. "Protecting Sensitive Compartmented Information Within Information Systems." DCID 6/3. Superseded by ICD 503. Superseding document retrieved 17 May 2021. Available at [https://www.dni.gov/files/documents/ICD/ICD\\_503.pdf](https://www.dni.gov/files/documents/ICD/ICD_503.pdf).

the corresponding chip/block being declared a bad block. In the event this bad block is not already in the corresponding board's bad block table, a new bad block entry will be appended onto the board's bad block table. Note that this new entry will not have the secure erase flag set.

- c. Second Erase. Every memory chip shall be erased. Any erase failures reported by the memory chips will result in the corresponding chip/block being declared a bad block. In the event this bad block is not already in the corresponding board's bad block table, a new bad block entry will be appended onto the board's bad block table. Note that this new entry will not have the secure erase flag set.
- d. Second Write (0xAA). Every memory chip location is recorded with the pattern 0xAA. As each location is written, the data is read back to guarantee that all bits were written to the expected pattern. Any write failures reported by the memory chips or any data errors will result in the corresponding chip/block being declared a bad block. In the event this bad block is not already in the corresponding board's bad block table, a new bad block entry will be appended onto the board's bad block table. Note that this new entry will not have the secure erase flag set.
- e. Third Erase. Every memory location is erased. Any erase failures reported by the memory chips will result in the corresponding chip/block being declared a bad block. In the event this bad block is not already in the corresponding board's bad block table, a new bad block entry will be appended onto the board's bad block table. Note that this new entry will not have the secure erase flag set.
- f. Usable Secure Erased Blocks. All blocks that do not have an entry in the bad block table are now considered to be secure erased.
- g. Unusable Secure Erased Blocks. If a bad block entry contains the flag indicating it has already been secure erased, this block has already been secure erased and requires no further processing, since it is known that this block was skipped during the previous recording.
- h. Insecure Bad Block Processing. A board's bad block table may contain bad block entries that have not previously been secure erased. If any such entries exist, the following steps are performed on each block.
  - Write Zeros Loop. For each page in the block, a pattern of all zeros is written to the page, and the page is checked to determine if any unexpected ones (UOs) are found. If any UOs are found, the page is re-written to all zeros. This process is repeated up to 16 times. After all allowed re-writes, the board, chip, and block numbers of the block containing any remaining UOs are written to a failed erase table.
  - Write Ones Loop. For each page in the block, the page is erased (to all ones) and checked to determine if any unexpected zeros (UZs) are found. If any UZs are found, another erase command is issued to the block. This process is repeated up to 16 times. After all allowed erase operations, the board, chip, and block numbers of the block containing any remaining UZs are written to the failed erase table.

- i. Failed Erase Table Processing. Any remaining entries in the failed erase table correspond to blocks that cannot be erased. These blocks may still contain user data and therefore are declared to have failed the secure erase.

A count of the number of bad blocks in the failed erase table that have not been secure erased is returned as part of the secure erase results. A non-zero count indicates a secure erase failure of at least one block. A command will allow the user to retrieve the failed erase table. A command will also allow a user to retrieve the data from such blocks and manually determine if these blocks can be designated as “Secure Erased.” In most cases, a single stuck bit will not compromise any user data and the offending block can be manually declared to be secure erased. If the results of manual inspection are indeterminate, the chip containing the failed block must be removed and destroyed, and the secure erase procedure must be repeated.

- j. Secure Erase Completion. When all blocks are secure erased (no entries in the failed erase table), the content of the file is the ASCII string “Secure Erase” repeated over and over.

This page intentionally left blank.

## APPENDIX 10-C

### Citations

- Department of Defense. “Security Requirements for Automated Information Systems (AIs).” DoDD 5200.28. Canceled by DoDI 8500.01. Superseding document retrieved 17 May 2021. Available at [https://www.esd.whs.mil/Portals/54/Documents/DD/issuances/dodi/850001\\_2014.pdf](https://www.esd.whs.mil/Portals/54/Documents/DD/issuances/dodi/850001_2014.pdf).
- Director of Central Intelligence. “Protecting Sensitive Compartmented Information Within Information Systems.” DCID 6/3. Superseded by ICD 503. Superseding document retrieved 17 May 2021. Available at [https://www.dni.gov/files/documents/ICD/ICD\\_503.pdf](https://www.dni.gov/files/documents/ICD/ICD_503.pdf).
- Institute of Electrical and Electronics Engineers. *IEEE Standard for a High Performance Serial Bus: Amendment 2*. IEEE 1394b-2002. New York: Institute of Electrical and Electronics Engineers, 2002.
- . *IEEE Standard for Information technology - Telecommunications and information exchange between systems...Amendment 3: Data Terminal Equipment (DTE) Power via the Media Dependent Interface (MDI) Enhancements*. IEEE 802.3at-2009. October 2009. Superseded by update. Retrieved 17 May 2021. Available with registration at <http://standards.ieee.org/findstds/standard/802.3at-2009.html>.
- International Committee for Information Technology Standards. “Fibre Channel - Private Loop SCSI Direct Attach (FC-PLDA).” INCITS TR-19-1998. January 1998. Retrieved 17 May 2021. Available for purchase at <http://www.techstreet.com/incits/searches/385689>. Replaced by “INCITS Technical Report - for Information Technology - Fibre Channel - Device Attach (FC-DA).” INCITS TR-36-2004. February 2005. Retrieved 17 May 2021. Available for purchase at <http://www.techstreet.com/incits/searches/385707>.
- International Organization for Standardization. *Data elements and interchange formats-- Information interchange--Representation of dates and times*. ISO 8601:2004. Geneva: International Organization for Standardization, 2004.
- International Organization for Standardization/International Electrotechnical Commission. *Information Technology -Universal Coded Character Set (UCS)*. ISO/IEC 10646:2012. May 2012. Superseded by ISO/IEC 10646:2017. Superseding document retrieved 17 May 2021. Available at <http://standards.iso.org/ittf/PubliclyAvailableStandards/index.html>.
- Internet Engineering Task Force. “Dynamic Host Configuration Protocol.” RFC 2131. March 1997. Updated by RFC 5494, RFC 4361, RFC 6842, and RFC 3396. Retrieved 17 May 2021. Available at <http://datatracker.ietf.org/doc/rfc2131/>.
- . “Extensions to FTP.” RFC 3659. March 2007. May be superseded or amended by update. Retrieved 17 May 2021. Available at <http://datatracker.ietf.org/doc/rfc3659/>.

- . “File Transfer Protocol (FTP).” RFC 959. October 1985. Updated by RFC 7151, RFC 5797, RFC 2773, RFC 2228, RFC 2640, RFC 3659. Retrieved 17 May 2021. Available at <http://datatracker.ietf.org/doc/rfc959/>.
  - . “Internet Control Message Protocol.” RFC 792. September 1981. Updated by RFC 950, RFC 4884, RFC 6633, RFC 6918. Retrieved 17 May 2021. Available at <http://datatracker.ietf.org/doc/rfc792/>.
  - . “Internet Protocol.” RFC 791. September 1981. Updated by RFC 1349, RFC 6864, and RFC 2474. Retrieved 17 May 2021. Available at <http://datatracker.ietf.org/doc/rfc791/>.
  - . “Internet Small Computer Systems Interface (iSCSI).” RFC 3720. April 2004. Obsoleted by RFC 7143. Retrieved 17 May 2021. Available at <http://datatracker.ietf.org/doc/rfc3720/>.
  - . “Internet Small Computer System Interface (iSCSI) Corrections and Clarifications.” RFC 5048. October 2007. Updated by RFC 7146, obsoleted by RFC 7143. Retrieved 17 May 2021. May be superseded or amended by update. Available at <http://datatracker.ietf.org/doc/rfc5048/>.
  - . “Multi-Protocol Label Switching (MPLS) Support of Differentiated Services.” RFC 3270. May 2002. Updated by RFC 5462. Retrieved 17 May 2021. Available at <http://datatracker.ietf.org/doc/rfc3270/>.
  - . “Service Location Protocol, Version 2.” RFC 2608. June 1999. Updated by RFC 3224. Retrieved 17 May 2021. Available at <http://datatracker.ietf.org/doc/rfc2608/>.
  - . “Telnet Linemode Option.” D. Borman, ed. RFC 1184. October 1990. May be superseded or amended by update. Retrieved 17 May 2021. Available at <http://datatracker.ietf.org/doc/rfc1184/>.
  - . “Telnet Option Specifications.” RFC 855. May 1983. May be superseded or amended by update. Retrieved 17 May 2021. Available at <http://datatracker.ietf.org/doc/rfc855/>.
  - . “Telnet Protocol Specification.” RFC 854. May 1983. Updated by RFC 5198. Retrieved 17 May 2021. Available at <http://tools.ietf.org/html/rfc854>.
- National Security Agency. “NSA/CSS Storage Device Declassification Manual.” Manual 9-12. 15 December 2014. May be superseded by update. Retrieved 17 May 2021. Available at <https://www.nsa.gov/Portals/70/documents/resources/everyone/media-destruction/storage-device-declassification-manual.pdf>.
- North Atlantic Treaty Organization. “NATO Advanced Data Storage Interface (NADSI).” STANAG 4575 (Edition 3). 8 May 2009. Superseded by NATO Standard AEDP-6 Edition B Version 4.. Superseding document retrieved 17 May 2021. Available at <https://nso.nato.int/nso/zPublic/ap/PROM/AEDP-06%20EDB%20V4%20E.pdf>.

\*\*\*\* END OF CHAPTER 10 \*\*\*\*



## CHAPTER 11

### Recorder Data Packet Format Standard

<b>Changes to This Edition of Chapter 11</b> .....	<b>11-v</b>
<b>Acronyms</b> .....	<b>11-vii</b>
<b>Chapter 11. Packet Format Standard</b> .....	<b>11-1</b>
<b>11.1 General</b> .....	<b>11-1</b>
<b>11.2 Data Format Definitions</b> .....	<b>11-1</b>
11.2.1 Common Packet Elements .....	11-1
11.2.2 PCM Data Packets .....	11-12
11.2.3 Time Data Packets .....	11-23
11.2.4 MIL-STD-1553 Packets.....	11-27
11.2.5 Analog Data Packets .....	11-37
11.2.6 Discrete Data Packets .....	11-46
11.2.7 Computer-Generated Data Packets .....	11-49
11.2.8 ARINC-429 Data Packets .....	11-64
11.2.9 Message Data Packets.....	11-66
11.2.10 Video Packets.....	11-68
11.2.11 Image Packets .....	11-77
11.2.12 UART Data Packets .....	11-86
11.2.13 IEEE 1394 Data Packets .....	11-88
11.2.14 Parallel Data Packet .....	11-93
11.2.15 Ethernet Data Packets .....	11-95
11.2.16 Time Space Position Information and Combat Training Systems Data Packets .....	11-101
11.2.17 Controller Area Network Bus Packets .....	11-108
11.2.18 Fibre Channel Packets.....	11-111
<b>Appendix 11-A. Definitions</b> .....	<b>A-1</b>
<b>Appendix 11-B. Citations</b> .....	<b>B-1</b>

### Table of Figures

Figure 11-1. Overall Packet Structure .....	11-2
Figure 11-2. Packet Trailer for 32-Bit Data Checksum.....	11-4
Figure 11-3. Packet Trailer for 8-Bit Data Checksum.....	11-4
Figure 11-4. Secondary Header Chapter 4 Time .....	11-10
Figure 11-5. Secondary Header IEEE 1588 Time .....	11-10
Figure 11-6. Secondary Header ERTC Time .....	11-10
Figure 11-7. Pulse Code Modulation Packet Channel-Specific Data Format .....	11-13
Figure 11-8. 32-Bit Alignment Mode Example, 16-Bit Data Words (32-Bit Word Addressing).....	11-19

Figure 11-9.	32-Bit Alignment Mode Example, 16-Bit Data Words (16-Bit Word Addressing) .....	11-19
Figure 11-10.	Pulse Code Modulation Intra-Packet Header.....	11-20
Figure 11-11.	DQE PCM Channel-Specific Data, Format 2 .....	11-21
Figure 11-12.	Time Packet Channel-Specific Data Format.....	11-23
Figure 11-13.	Time Data-Packet Format, Day Format.....	11-25
Figure 11-14.	Time Data-Packet Format, Day, Month, and Year Format.....	11-25
Figure 11-15.	Format 2 Network Time Packet Channel-Specific Data Format .....	11-27
Figure 11-16.	Format 2 Network Time Packet NTP Time Data .....	11-27
Figure 11-17.	Format 2 Network Time Packet PTP Time Data .....	11-27
Figure 11-18.	MIL-STD-1553 Packet Channel-Specific Data Format .....	11-28
Figure 11-19.	MIL-STD-1553 Intra-Packet Data Header .....	11-29
Figure 11-20.	Block Status Word .....	11-29
Figure 11-21.	Gap Times Word.....	11-31
Figure 11-22.	16PP194 Message Transaction .....	11-33
Figure 11-23.	Military Standard 1553 16PP194 Packet Channel-Specific Data Format .....	11-33
Figure 11-24.	Military Standard 1553 16PP194 Intra-Packet Data Header Format.....	11-34
Figure 11-25.	Military Standard 1553 26-Bit 16PP194 Word .....	11-36
Figure 11-26.	16PP194 Word Format .....	11-37
Figure 11-27.	Analog Packet Channel-Specific Data Word.....	11-38
Figure 11-28.	Analog Packet Format 3, I/Q Sampling.....	11-44
Figure 11-29.	Analog Packet Format 3, Channel-Specific Data Word .....	11-46
Figure 11-30.	Discrete Packet Channel Data Word.....	11-47
Figure 11-31.	Discrete Data Format .....	11-47
Figure 11-32.	Discrete Event Intra-Packet Header.....	11-48
Figure 11-33.	Computer-Generated Format 0 Channel-Specific Data Word.....	11-49
Figure 11-34.	Computer-Generated Format 1 Channel-Specific Data Word.....	11-50
Figure 11-35.	Computer-Generated Format 2 Channel-Specific Data Word.....	11-52
Figure 11-36.	Events Recording Period.....	11-53
Figure 11-37.	Recording Event Intra-Packet Header .....	11-55
Figure 11-38.	Recording Event Entry Layout .....	11-56
Figure 11-39.	Format Showing Root Index Packet .....	11-58
Figure 11-40.	Computer-Generated Format 3 Channel-Specific Data Word.....	11-58
Figure 11-41.	Recording Index Intra-Packet Header.....	11-59
Figure 11-42.	Recording Node Index Entry Layout.....	11-61
Figure 11-43.	Computer-Generated Format 4 Channel-Specific Data Word.....	11-62
Figure 11-44.	ARINC-429 Packet Channel-Specific Data Word.....	11-65
Figure 11-45.	Intra-Packet Data Header Format .....	11-65
Figure 11-46.	Complete Message Channel-Specific Data Word.....	11-66
Figure 11-47.	Segmented Message Channel-Specific Data Word .....	11-67
Figure 11-48.	Message Data Intra-Packet Header .....	11-67
Figure 11-49.	Intra-Packet Data Header Format .....	11-68
Figure 11-50.	Video Packet Channel-Specific Data Word.....	11-70
Figure 11-51.	Format 0 (Legacy) Video Frame Format, 16-Bit Little-Endian Aligned...	11-71

Figure 11-52.	Format 0 (Legacy) Video Frame Format, 16-Bit Big-Endian (Native) Aligned.....	11-71
Figure 11-53.	Video Packet, Format 0 Intra-Packet Header .....	11-71
Figure 11-54.	MPEG-2 Stream Channel-Specific Data Word .....	11-73
Figure 11-55.	Video Packet, Format 2 Intra-Packet Header .....	11-74
Figure 11-56.	MJPEG 2000 Video Packet Channel-Specific Data Word.....	11-76
Figure 11-57.	MJPEG Video Intra-Packet Header .....	11-77
Figure 11-58.	Image Packet Channel-Specific Data Word .....	11-78
Figure 11-59.	Image Data Intra-Packet Header, Format 0 .....	11-79
Figure 11-60.	Still Imagery Packet Channel-Specific Data Word .....	11-80
Figure 11-61.	Still Imagery Intra-Packet Header .....	11-81
Figure 11-62.	Dynamic Imagery Packet Channel-Specific Data Word .....	11-82
Figure 11-63.	Dynamic Imagery Intra-Packet Header .....	11-85
Figure 11-64.	UART Packet Channel-Specific Data Word.....	11-86
Figure 11-65.	UART Data Intra-Packet Header .....	11-87
Figure 11-66.	Intra-Packet Data Header Format .....	11-87
Figure 11-67.	IEEE 1394 Channel-Specific Data Word .....	11-88
Figure 11-68.	IEEE 1394 Intra-Packet Header.....	11-89
Figure 11-69.	IEEE 1394 Event Data Word.....	11-89
Figure 11-70.	IEEE 1394 Channel-Specific Data Word, Format 1 .....	11-91
Figure 11-71.	IEEE 1394 Format 1 Intra-Packet Header .....	11-91
Figure 11-72.	Intra-Packet Data Header - Message ID Word .....	11-92
Figure 11-73.	Parallel Packet Channel-Specific Data Word .....	11-93
Figure 11-74.	Parallel Data, Up to 8-Bit-Wide Words.....	11-94
Figure 11-75.	Parallel Data, 9-Bit to 16-Bit-Wide Words.....	11-94
Figure 11-76.	Parallel Data (Example: 28-Bit-Wide Words).....	11-94
Figure 11-77.	DCRsi Scan, 9-Auxiliary Data Byte + 4326 Bytes.....	11-95
Figure 11-78.	Ethernet Data Packet Format 0 Channel-Specific Data Word.....	11-96
Figure 11-79.	Ethernet Data Format 0 Intra-Packet Header.....	11-97
Figure 11-80.	Intra-Packet Frame ID Word .....	11-97
Figure 11-81.	Ethernet Data Packet Format 1 Channel-Specific Data Word.....	11-100
Figure 11-82.	Ethernet Data Format 1 Intra-Packet Header.....	11-100
Figure 11-83.	Intra-Packet Data Header.....	11-101
Figure 11-84.	NMEA-RTCM Packet Channel-Specific Data Word.....	11-103
Figure 11-85.	NMEA-RTCM Intra-Packet Time Stamp.....	11-103
Figure 11-86.	NMEA-RTCM Intra-Packet Data Header .....	11-104
Figure 11-87.	EAG ACMI Packet Channel-Specific Data Word.....	11-105
Figure 11-88.	EAG ACMI Data Intra-Packet Time Stamp .....	11-105
Figure 11-89.	EAG ACMI Intra-Packet Data Header .....	11-105
Figure 11-90.	ACTTS Packet Channel-Specific Data Word.....	11-107
Figure 11-91.	ACTTS Data Intra-Packet Time Stamp .....	11-107
Figure 11-92.	ACTTS Data Intra-Packet Data Header.....	11-108
Figure 11-93.	Complete CAN Bus Format 0 Channel-Specific Data Word .....	11-109
Figure 11-94.	CAN Bus Data Format 0 Intra-Packet Data Header .....	11-109
Figure 11-95.	Intra-Packet Message Header .....	11-109
Figure 11-96.	Intra-Packet ID Word.....	11-110

Figure 11-97.	CAN Bus Format 0 Message .....	11-110
Figure 11-98.	Fibre Channel Data Packet Channel-Specific Data Word .....	11-111
Figure 11-99.	Fibre Channel Data Format 0 Intra-Packet Header.....	11-112
Figure 11-100.	Fibre Channel Data Format 0 Intra-Packet Frame ID Word.....	11-112
Figure 11-101.	Fibre Channel Data Packet Channel-Specific Data Word Format.....	11-115
Figure 11-102.	Fibre Channel Data Format 1 Intra-Packet Header.....	11-115
Figure 11-103.	Fibre Channel Data Format 1, (FC-FS Layer) Intra-Packet Frame Status Word.....	11-115

### Table of Tables

Table 11-1.	General Packet Structure.....	11-2
Table 11-2.	32-Bit Packet Format Layout.....	11-3
Table 11-3.	Packet Requirements.....	11-4
Table 11-4.	Data Type Names and Descriptions.....	11-6
Table 11-5.	General PCM Data Packet, Format 1 .....	11-12
Table 11-6.	PCM Data-Unpacked (16-Bit Alignment Mode) Sample Packet .....	11-15
Table 11-7.	PCM Data-Unpacked (32-Bit Alignment Mode) Sample Packet .....	11-16
Table 11-8.	PCM Data-Packed (16-Bit Alignment Mode) Sample Packet.....	11-17
Table 11-9.	PCM Data-Packed (32-Bit Alignment Mode) Sample Packet.....	11-17
Table 11-10.	PCM Data-Throughput (16-Bit Alignment Mode) Sample Packet .....	11-18
Table 11-11.	PCM Data-Throughput (32-Bit Alignment Mode) Sample Packet .....	11-19
Table 11-12.	General PCM Data Packet, Format 2.....	11-21
Table 11-13.	Data (16-Bit Alignment Mode) Sample Packet, Format 2 .....	11-22
Table 11-14.	PCM Data (32-Bit Alignment Mode) Sample Packet, Format 2 .....	11-23
Table 11-15.	General Time Data Packet, Format 1 .....	11-24
Table 11-16.	Units of Measure.....	11-26
Table 11-17.	General Time Data Packet, Format 1 .....	11-26
Table 11-18.	MIL-STD-1553 Data Packet, Format 1 Basic Layout .....	11-28
Table 11-19.	MIL-STD-1553 Data Packet, Format 1 .....	11-31
Table 11-20.	MIL-STD-1553 16PP194 Data Packet Basic Layout .....	11-33
Table 11-21.	MIL-STD-1553 16PP194 Data Packet .....	11-35
Table 11-22.	Generic Analog Data Packet, Format 1 .....	11-37
Table 11-23.	Analog Data Packet-Unpacked Mode, msb Padding.....	11-42
Table 11-24.	Analog Data Packet-Unpacked Mode, lsb Padding.....	11-42
Table 11-25.	Analog Data Packet-Packed Mode Packet.....	11-43
Table 11-26.	Analog Data Packet, Format 3.....	11-45
Table 11-27.	General Discrete Data Packet, Format 1 .....	11-47
Table 11-28.	Discrete Data Packet Format .....	11-48
Table 11-29.	General Computer-Generated Data Packet Format .....	11-49
Table 11-30.	General Recording Event Packet Format.....	11-55
Table 11-31.	General Recording Root Index Packet.....	11-59
Table 11-32.	Recording Root Index Entry Layout.....	11-60
Table 11-33.	General Recording Node Index Packet.....	11-61
Table 11-34.	SHA2-256 Checksum Packet Layout .....	11-63
Table 11-35.	Currently Selected Channel Layout .....	11-63

Table 11-36. ARINC-429 Data Packet Format ..... 11-64  
 Table 11-37. Message Data Packet Format..... 11-66  
 Table 11-38. General MPEG-2/H.264 Video Packet, Format 0 ..... 11-69  
 Table 11-39. Format 0 MPEG-2/H.264 Video Data Packet..... 11-72  
 Table 11-40. General AVC/H.264 Video Packet, Format 2 ..... 11-73  
 Table 11-41. MJPEG Video Packet, Format 4 ..... 11-75  
 Table 11-42. Image Packet, Format 0 ..... 11-77  
 Table 11-43. Still Imagery Packet, Format 1 ..... 11-79  
 Table 11-44. Dynamic Imagery Packet, Format 1 ..... 11-81  
 Table 11-45. UART Data Packet Format ..... 11-86  
 Table 11-46. IEEE 1394 Data Packet, Format 0 ..... 11-88  
 Table 11-47. IEEE 1394 Data Packet, Format 1 ..... 11-91  
 Table 11-48. Parallel Data Packet, Format 0..... 11-93  
 Table 11-49. Ethernet Data Packet, Format 0 ..... 11-95  
 Table 11-50. Ethernet Data Format 1 ..... 11-98  
 Table 11-51. Comparison of Normal Ethernet and ARINC-664 Frames..... 11-99  
 Table 11-52. NMEA-RTCM Data Packet Format ..... 11-102  
 Table 11-53. EAG ACMI Data Packet Format ..... 11-104  
 Table 11-54. ACTTS Data Packet Format ..... 11-106  
 Table 11-55. Controller Area Network Bus Data Packet, Format 0 ..... 11-108  
 Table 11-56. Fibre Channel Data Packet, Format 0 ..... 11-111  
 Table 11-57. Fibre Channel Data Packet, Format 1 ..... 11-114

<b>Changes to This Edition of Chapter 11</b>		
Paragraph	Change Request	Description
Various		Most tables and figures have been renumbered
<a href="#">11.2.2.3</a>	RR_20_CR-01	Additions and corrections to PCM Format 2
<a href="#">11.2.1.1g</a>	RR_20_CR-04	Clarification of overflow bit
<a href="#">11.2.10</a>	RR_17_CR-03	Institutional adjustment for video formats
<a href="#">11.2.10.2</a>	RR_17_CR-03	Video Format 1 is deprecated
<a href="#">11.2.10.3</a>	RR_17_CR-03	Video Format 2 is laundered
<a href="#">11.2.10.4</a>	RR_17_CR-03	Video Format 3 is deprecated
<a href="#">11.2.5.3</a>	RR_19_CR-05	Place holder for Analog Data Packet, Format 2
<a href="#">11.2.5.4</a>	RR_19_CR-05	Added Analog Data Packet, Format 3 (IF I/Q Recording)
<a href="#">11.2.1.5</a>	RR_17_CR-01	Added note regarding proposed version 2 header

This page intentionally left blank.

## Acronyms

μs	microsecond
ACTTS	Air Combat Test and Training System
ARINC	Aeronautical Radio, Incorporated
BC	bus controller
CAN	controller area network
CBR	constant bit rate
CIU	communication interface unit
CSDW	channel-specific data word
CTS	Combat Training Systems
DCRsi	Digital Cartridge Recording System - Incremental
DQE	Data Quality Encapsulation
ERTC	extended relative time counter
Gbps	gigabit per second
GHz	gigahertz
GPS	Global Positioning System
IAW	in accordance with
IEC	International Electrotechnical Commission
IEEE	Institute of Electrical and Electronics Engineers
IETF	Internet Engineering Task Force
IF	intermediate frequency
IP	Internet Protocol
IPDH	intra-packet data header
IPH	intra-packet header
IPMH	intra-packet message header
IPTS	intra-packet time stamp
I/Q	in-phase and quadrature
IRIG	Inter-Range Instrumentation Group
ISO	International Organization for Standards
ITU-T	International Telecommunications Union/Telecommunication Standardization Sector
KB	kilobyte
KITS	Kadena Interim Training System
KLV	key-length-value
LDPC	Low Density Parity Check
lsb	least significant bit
LSLW	least significant long word
MAC	media access control
Mbps	megabit per second
MHz	megahertz
MIL-STD	Military Standard
MISP	Motion Imagery Standards Profile
MPEG	Moving Picture Experts Group
ms	millisecond
msb	most significant bit
MSLW	most significant long word

NTP	Network Time Protocol
PAT	program association table
PCM	pulse code modulation
PCR	program clock reference
PES	program elementary stream
PID	program ID
PMT	program map table
PS	program stream
PTP	Precision Time Protocol
RCC	Range Commanders Council
RIU	remote interface unit
RS	Recommended Standard
RT	remote terminal
RTC	relative time counter
SCR	system clock reference
STC	Space Time Code
TCG	time code generator
TMATS	Telemetry Attributes Transfer Standard
TS	transport stream
TSPI	time, space, position information
UART	Universal Asynchronous Receiver and Transmitter
UDP	User Datagram Protocol
UTC	Universal Coordinated Time



## CHAPTER 11

### Packet Format Standard

#### 11.1 General

A large number of unique and proprietary data structures has been developed for specific data recording applications that required unique decoding software programs. The activities of writing unique decoding software, checking the software for accuracy, and decoding the data formats are extremely time-consuming and costly.

Specifically, this packet format standard shall be usable with multiplexing of both synchronous and asynchronous digital inputs such as pulse code modulation (PCM); Military Standard (MIL-STD) 1553 data bus, time, analog, video; Aeronautical Radio, Inc. (ARINC) 429; discrete; and Universal Asynchronous Receiver and Transmitter (UART) containing Recommended Standard (RS)-232/422/485 communication data. This packet standard will allow use of a common set of data interpretation libraries to reduce the cost of producing data analysis systems.

 <p><b>NOTE</b></p>	<p>Within this standard, where text, figures, or tables are used to provide descriptions, meaning, and/or explanations, the text shall take precedence over figures and tables.</p>
--	---

The data format structures (packet header, secondary packet header, channel-specific data word [CSDW], intra-packet data header [IPDH], and packet trailer) described in Section [11.2](#) are defined to have the following bit and byte orientation. The least significant byte shall be transmitted first; the least significant bit (lsb) of each byte shall be transmitted first, with most significant bit (msb) transmitted last; and data is read from the lowest logical address first. This ordering is commonly referred to as “Little Endian.” The packet data shall remain in its native byte order format.

#### 11.2 Data Format Definitions

##### 11.2.1 Common Packet Elements

Data shall have three required parts: a packet header, a packet body, and a packet trailer, and an optional part if enabled, a packet secondary header. A packet will always conform to the structure outlined in [Figure 11-1](#).

- a. A packet has the basic structure shown in [Table 11-1](#). Note that the width of the structure is not related to any number of bytes or bits. This table is merely to represent relative packet elements and their placement within the packet. See [Table 11-2](#) for a diagram of the generic packet format. This table does not depict the bit lengths of each field. Word sizes of 8 bits, 16 bits, and 32 bits are used depending on the data type.

To further clarify the packet layout, [Table 11-2](#) shows the generic packet in a 32-bit, little-endian format, and assumes 16-bit data words and data checksum.

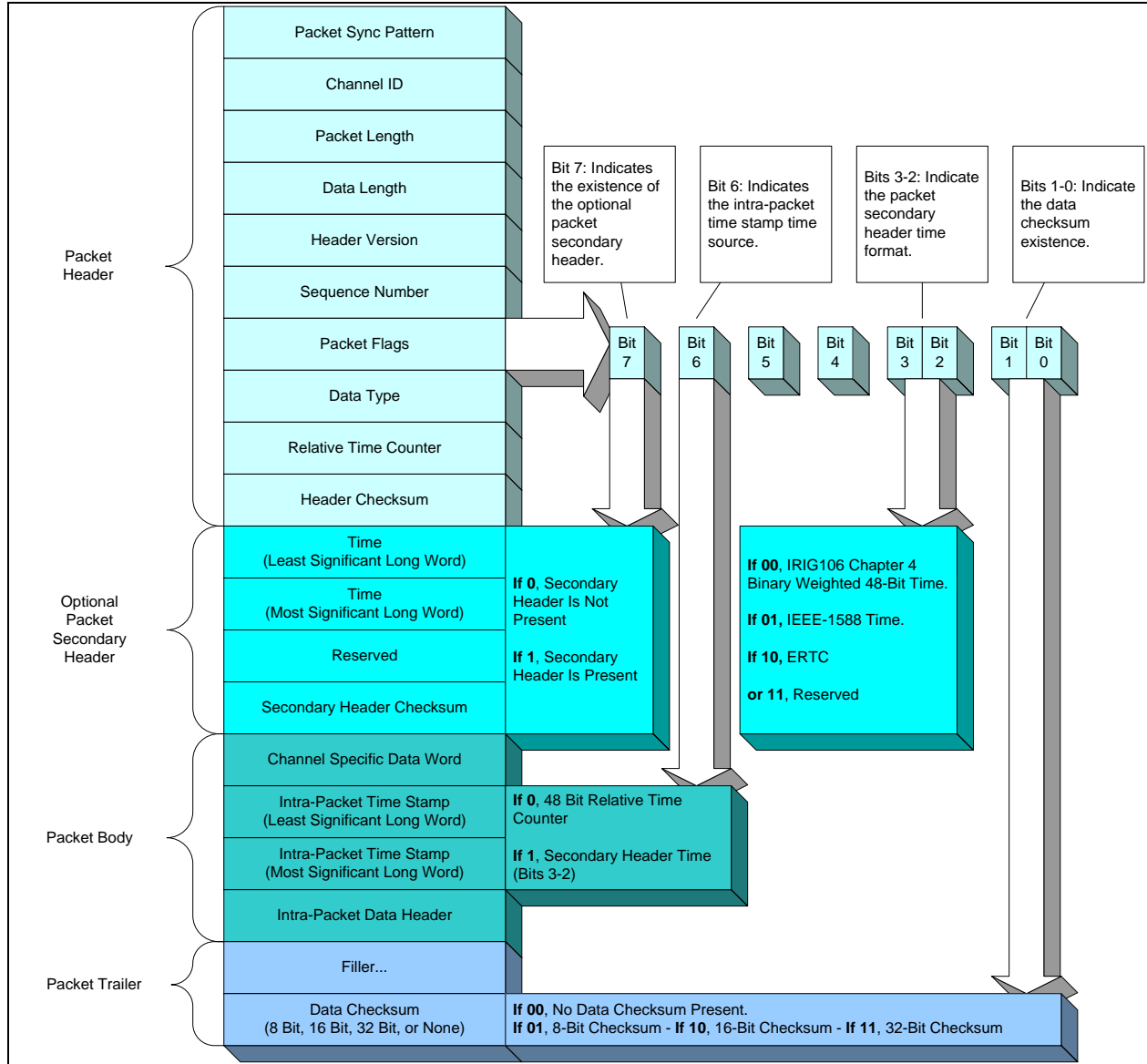

Figure 11-1. Overall Packet Structure

Table 11-1. General Packet Structure	
PACKET SYNC PATTERN	Packet Header
CHANNEL ID	
PACKET LENGTH	
DATA LENGTH	
DATA TYPE VERSION	
SEQUENCE NUMBER	
PACKET FLAGS	
DATA TYPE	
RELATIVE TIME COUNTER	
HEADER CHECKSUM	

TIME	Packet Secondary Header (Optional)
RESERVED	
SECONDARY HEADER CHECKSUM	
CHANNEL-SPECIFIC DATA	Packet Body
INTRA-PACKET TIME STAMP 1	
INTRA-PACKET DATA HEADER 1	
DATA 1	
:	
INTRA-PACKET TIME STAMP N	
INTRA-PACKET DATA HEADER N	
DATA n	Packet Trailer
DATA CHECKSUM	

Table 11-2. 32-Bit Packet Format Layout					
msb				lsb	
31		16	15	0	
CHANNEL ID		PACKET SYNC PATTERN			
PACKET LENGTH					
DATA LENGTH					
DATA TYPE	PACKET FLAGS	SEQUENCE NUMBER	DATA TYPE VERSION	Packet Header	
RELATIVE TIME COUNTER					
HEADER CHECKSUM		RELATIVE TIME COUNTER			
TIME (LEAST SIGNIFICANT LONG WORD [LSLW])					
TIME (MOST SIGNIFICANT LONG WORD [MSLW])					
SECONDARY HEADER CHECKSUM		RESERVED			(Optional) Packet Secondary Header
CHANNEL-SPECIFIC DATA					
INTRA-PACKET TIME STAMP 1					
INTRA-PACKET TIME STAMP 1					
INTRA-PACKET DATA HEADER 1					
DATA 1 WORD 2		DATA 1 WORD 1			
DATA 1 WORD N		:			
INTRA-PACKET TIME STAMP 2					
INTRA-PACKET TIME STAMP 2					
INTRA-PACKET DATA HEADER 2					
DATA 2 WORD 2		DATA 2 WORD 1			
DATA 2 WORD N		:			
:					
INTRA-PACKET TIME STAMP N					
INTRA-PACKET TIME STAMP N					
INTRA-PACKET DATA HEADER N					
DATA N WORD 2		DATA N WORD 1			

DATA N WORD N	:	
[FILLER]		Packet Trailer
DATA CHECKSUM		

Depending on the data type, the size of the data checksum can contain 32 bits, 16 bits, 8 bits, or the checksum can be entirely left out. For a 32-bit data checksum, the packet trailer would be as shown in [Figure 11-2](#).

msb 7	lsb 0	
[ Filler ]		Packet Trailer
Data Checksum (lsb)		
Data Checksum		
Data Checksum		
Data Checksum (msb)		

Figure 11-2. Packet Trailer for 32-Bit Data Checksum

- b. For an 8-bit data checksum, the packet trailer would be as shown in [Figure 11-3](#).

msb 7	lsb 0	
[ Filler ]		Packet Trailer
Data Checksum		

Figure 11-3. Packet Trailer for 8-Bit Data Checksum

- c. The size of a single packet may be a maximum of 524,288 ( $2^{19}$ ) bytes as shown in [Table 11-3](#). This includes the packet header, packet body, packet trailer, and optional packet secondary header if enabled. The only exception to the packet size limit is the Computer-Generated Data Packet, Format 1 setup record, which may be a maximum of 134,217,728 ( $2^{27}$ ) bytes. Any packet that requires more than 524,288 bytes may generate multiple packets by utilizing the packet sequence counter. Some packet types allow a single data set to span multiple packets if the data set size or time does not fall under packet maximums. The specific mechanism allowing packet data spanning for each data type is described within that data type's section.

Table 11-3. Packet Requirements		
Packet Type	Required	Maximum Packet Size
Computer-Generated Data Packet, Format 1 Setup Record	Yes	134,217,728 bytes
Time Data Packet	Yes	524,288 bytes
All other data type packets with the exception of Computer-Generated Data Packet, Format 1 setup record, time data packets, and Computer-Generated Data Packet, Format 3 recording index (root index)	No	524,288 bytes

**Table 11-3. Packet Requirements**

Computer-Generated Data Packet, Format 3 recording index (root index)	Yes, if recording events are enabled. No, if recording events are disabled.	524,288 bytes
---	--	---------------

- d. (Reserved)
- e. All packets that are generated shall contain data. Filler only, idle (as defined by medium or interface) only, or empty packets shall not be allowed.
- f. All reserved bit fields in packet headers or CSDWs shall be set to zero (0x0).
- g. (Reserved)
- h. Once version bits and packet structure bits have been used to indicate a value or setting for each data type and its associated channel, they shall not change for that data type and its associated channel within the operational session (e.g., recording).

#### 11.2.1.1 Packet Header, Version 1

The length of the packet header is fixed at 24 bytes (192 bits). The packet header is mandatory and shall consist of ten fields, positioned contiguously as shown in [Table 11-2](#) and defined below.

- a. Packet Sync Pattern. These 2 bytes contain a static sync value for every packet. The packet sync pattern value shall be 0xEB25.
- b. Channel ID. These 2 bytes contain a value representing the packet channel ID. All channels in a system must have a unique channel ID for each data source.
  - (1) Multiplexer Source ID. In a distributed multiplexer system, a multiplexer source ID is used to discern each multiplexer in the system. The setup record shall contain a “Number of Source Bits” recorder attribute (R-x\NSB) to specify the number of msbs (from the channel ID) that distinguish the multiplexer source ID. The remaining lsbs of the channel ID field shall be the channel ID for each data source acquired by the multiplexer.
  - (2) Reserved Channel ID. Channel ID 0x0000 is reserved, and as of 106-17 is used to insert only the Computer-Generated Data Packet, Format 1 setup record(s) or the Computer-Generated Data Packet, Format 4 Streaming Configuration records into the composite data stream.
  - (3) Available Channel IDs. All values not comprising the reserved channel ID are available. As of 106-13, when Computer-Generated Data Packet, Formats 0, 2, and 3 reside in a channel with ID 0x0001-0xFFFF, only one packet type shall exist per channel ID.
- c. Packet Length. These 4 bytes contain a value representing the length of the entire packet. The value shall be in bytes and is always a multiple of four (bit 1 and bit 0 shall always be zero). This packet length includes the packet header, packet secondary header (if

enabled), channel-specific data, intra-packet headers (IPHs), data, filler, and data checksum.

- d. **Data Length.** These 4 bytes contain a value representing the valid data length within the packet. This value shall be represented in bytes. Valid data length includes channel-specific data, IPDHs, intra-packet time stamp(s) (IPTS), and data but does not include packet trailer filler and data checksum.
- e. **Data Type Version.** This byte contains a value at or below the release version of the standard applied to the data types in [Table 11-4](#). The value shall be represented by the following bit patterns.

- 0x00 = Reserved
- 0x01 = Initial Release (Range Commanders Council [RCC] 106-04)
- 0x02 = RCC 106-05
- 0x03 = RCC 106-07
- 0x04 = RCC 106-09
- 0x05 = RCC 106-11
- 0x06 = RCC 106-13
- 0x07 = RCC 106-15
- 0x08 = RCC 106-17
- 0x09 = RCC 106-19
- 0x0A = RCC 106-22
- 0x0B through 0xFF = Reserved



Note: References to RCC 106-04 through RCC 106-15 refer to Chapter 10, while RCC 106-17 onward refer to Chapter 11.

<b>Table 11-4. Data Type Names and Descriptions</b>			
<b>Packet Header Value</b>	<b>Data Type Name</b>	<b>Data Type Description</b>	<b>Current Data Type Version</b>
0x00	Computer-Generated Data, Format 0	User-Defined	0x06
0x01	Computer-Generated Data, Format 1	Setup Record	0x09
0x02	Computer-Generated Data, Format 2	Recording Events	0x06
0x03	Computer-Generated Data, Format 3	Recording Index	0x06
0x04	Computer-Generated Data, Format 4	Streaming Configuration Records	0x08
0x05 – 0x07	Computer-Generated Data, Format 5-Format 7	Reserved for future use	0x06
0x08	PCM Data, Format 0	Reserved for future use	0x06
0x09	PCM Data, Format 1	Chapter 4, 7, or 8	0x06
0x0A	PCM Data, Format 2	DQE PCM	0x0A
0x0B - 0x0F	PCM Data, Format 3 - Format 7	Reserved for future use	0x06
0x10	Time Data, Format 0	Reserved for future use	0x06
0x11	Time Data, Format 1	RCC/Global Positioning System (GPS)/Relative Time Counter (RTC)	0x06



**Table 11-4. Data Type Names and Descriptions**

<b>Packet Header Value</b>	<b>Data Type Name</b>	<b>Data Type Description</b>	<b>Current Data Type Version</b>
0x12	Time Data, Format 2	Network Time	0x08
0x13-0x17	Time Data, Format 2-Format 7	Reserved for future use	0x06
0x18	MIL-STD-1553 Data, Format 0	Reserved for future use	0x06
0x19	MIL-STD-1553 Data, Format 1	MIL-STD-1553B Data	0x06
0x1A	MIL-STD-1553 Data, Format 2	16PP194 Bus	0x06
0x1B-0x1F	MIL-STD-1553 Data, Format 3-Format 7	Reserved for future use	0x06
0x20	Analog Data, Format 0	Reserved for future use	0x06
0x21	Analog Data, Format 1	Analog Data	0x06
0x23	Analog Data, Format 2	Reserved for future use	0x0A
0x24	Analog Data, Format 3	In-phase and quadrature (I/Q) recording of intermediate frequency (IF)	0x0A
0x25-0x27	Analog Data, Format 2-Format 7	Reserved for future use	0x06
0x28	Discrete Data, Format 0	Reserved for future use	0x06
0x29	Discrete Data, Format 1	Discrete Data	0x06
0x2A-0x2F	Discrete Data, Format 2-Format 7	Reserved for future use	0x06
0x30	Message Data, Format 0	Generic Message Data	0x06
0x31-0x37	Message Data, Format 1-Format 7	Reserved for future use	0x06
0x38	ARINC-429 Data, Format 0	ARINC-429 Data	0x06
0x39- 0x3F	ARINC-429 Data, Format 1-Format 7	Reserved for future use	0x06
0x40	Video Data, Format 0 (Legacy)	MPEG-2	0x0A
0x41	Video Data, Format 1 (Deprecated)	(Use Video Format 2)	0x0A
0x42	Video Data, Format 2	MPEG-2/H.264 Video	0x0A
0x43	Video Data, Format 3 (Deprecated)	MJPEG	0x0A
0x44	Video Data, Format 4	MJPEG-2000	0x07
0x45-0x47	Video Data, Format 3-Format 7	Reserved for future use	0x06
0x48	Image Data, Format 0	Image Data	0x06
0x49	Image Data, Format 1	Still Imagery	0x06
0x4A-	Image Data, Format 2	Dynamic Imagery	0x06
0x4B-0x4F	Image Data, Format 3-Format 7	Reserved for future use	0x06
0x50	UART Data, Format 0	UART Data	0x06
0x51-0x57	UART Data, Format 1-Format 7	Reserved for future use	0x06
0x58	IEEE 1394 Data, Format 0	IEEE 1394 Transaction	0x06
0x59	IEEE 1394 Data, Format 1	IEEE 1394 Physical Layer	0x06
0x5A-0x5F	IEEE 1394 Data, Format 2-Format 7	Reserved for future use	0x06
0x60	Parallel Data, Format 0	Parallel Data	0x06
0x61-0x67	Parallel Data, Format 1-Format 7	Reserved for future use	0x06

NEW

CHANGE

**Table 11-4. Data Type Names and Descriptions**

<b>Packet Header Value</b>	<b>Data Type Name</b>	<b>Data Type Description</b>	<b>Current Data Type Version</b>
0x68	Ethernet Data, Format 0	Ethernet Data	0x07
0x69	Ethernet Data, Format 1	Ethernet UDP Payload	0x06
0x6A-0x6F	Ethernet Data, Format 2-Format 7	Reserved for future use	0x06
0x70	TSPI/CTS Data, Format 0	GPS NMEA-RTCM	0x06
0x71	TSPI/CTS Data, Format 1	EAG ACMI	0x06
0x72	TSPI/CTS Data, Format 2	ACTTS	0x06
0x73- 0x77	TSPI/CTS Data, Format 3-Format 7	Reserved for future use	0x06
0x78	Controller Area Network Bus	CAN Bus	0x06
0x79	Fibre Channel Data, Format 0	Fibre Channel Data	0x07
0x7A	Fibre Channel Data, Format 1	Fibre Channel Data	0x08
0x7B – 0x80	Fibre Channel Data, Formats 2-7	Reserved for future use	0x08

- f. Sequence Number. This byte contains a value representing the packet sequence number for each channel ID. This is simply a counter that increments by  $n + 0x01$  to  $0xFF$  for every packet transferred from a particular channel and is not required to start at  $0x00$  for the first occurrence of a packet for the channel ID.

 <p><b>NOTE</b></p>	<p>The sequence number counter value for each channel in a session (e.g., recording) will repeat (rollover to <math>0x00</math>) after the sequence number counter has reached <math>0xFF</math>.</p>
--	---

 <p><b>NOTE</b></p>	<p>Each channel in a session shall have its own sequence counter providing a unique sequence number for that channel.</p>
--	---

- g. Packet Flags. This byte contains bits representing information on the content and format of the packet(s).

Bit 7: Indicates the presence or absence of the packet secondary header.

- 0 = Packet secondary header is not present.
- 1 = Packet secondary header is present.

Bit 6: Indicates the IPTS time source.

- 0 = Packet header 48-bit RTC.
- 1 = Packet secondary header time (bit 7 must be 1).

Bit 5: RTC sync error.

- 0 = No RTC sync error.
- 1 = RTC sync error has occurred.

Bit 4: Indicates the data overflow error.



- 0 = No data overflow.
- 1 = Data overflow has occurred.



 <p><b>NOTE</b></p>	<p>The assertion of the overflow flag, bit 4, indicates that an overflow condition was detected <b><u>before or during the creation of this packet.</u></b> An overflow condition may or may not indicate a loss of payload data.</p>
--	---

Bits 3-2: Indicate the packet secondary header time format.

- 00 = Chapter 4 binary weighted 48-bit time format. The two lsbs of the 64-bit packet secondary header time and IPTS shall be zero-filled.
- 01 = IEEE 1588 time format. The packet secondary header time and each IPTS shall contain a 64-bit timestamp represented in accordance with (IAW) the time representation type as specified by IEEE STD 1588-2008.<sup>1</sup> The 32 bits indicating seconds shall be placed into the MSLW portion of the secondary header and the 32 bits indicating nanoseconds shall be placed into the LSLW portion.
- 10 = 64-bit binary extended relative time counter (ERTC) with 1-nanosecond resolution. The counter shall be derived from a free-running 1-gigahertz (GHz) clock - similar to the RTC described below - just with higher resolution. When this option is used, the 10-megahertz (MHz) RTC shall be synchronized with the ERTC (RTC = ERTC/100).
- 11 = Reserved

Bits 1-0: Indicate data checksum existence.

- 00 = No data checksum present
- 01 = 8-bit data checksum present
- 10 = 16-bit data checksum present
- 11 = 32-bit data checksum present

- h. Data Type. This byte contains a value representing the type and format of the data. All values not used to define a data type are reserved for future data type growth. [Table 11-4](#) lists the data types and their descriptions.
- i. Relative Time Counter. These 6 bytes contain a value representing the 10-MHz RTC. This is a free-running 10-MHz binary counter represented by 48 bits that are common to all data channels. The counter shall be derived from a 10-MHz internal crystal oscillator and shall remain free-running during each session (e.g., recording).

 <p><b>NOTE</b></p>	<p>If enabled, the applicable data bit of the 48-bit value of the packet secondary time value shall correspond to the first bit of the data in the packet body (unless it is defined in each data type section).</p>
--	--

<sup>1</sup> Institute of Electrical and Electronics Engineers. *IEEE standard for a precision clock synchronization protocol for networked measurement and control systems*. IEEE 1588-2008. Geneva: International Electrotechnical Commission, 2008.

- j. Header Checksum. These 2 bytes contain a value representing a 16-bit arithmetic sum of all 16-bit words in the header excluding the header checksum word.

11.2.1.2 Packet Secondary Header (Optional), Version 1

The length of the packet secondary header is fixed at 12 bytes (96 bits). The packet secondary header is optional and when enabled shall consist of the three fields, positioned contiguously, in the following sequence.

- a. Time. These 8 bytes contain the value representing time in the format indicated by bits 2 and 3 of the packet flags in Subsection [11.2.1.1](#) item g. The secondary header can be enabled on a channel-by-channel basis but all channels that have a secondary header must use the same time source in bits 2-3 of the packet flags.

 <p><b>NOTE</b></p>	<p>The applicable data bit to which the 48-bit value of the packet secondary time value (if enabled) applies shall correspond to the first bit of the data in the packet body (unless it is defined in each data type section).</p>
--	---

When Chapter 4 binary weighted time is used, time shall be stored as shown in [Figure 11-4](#).

msb	lsb
31	0
16 15	
Micro-Seconds Word	Reserved
High Order Time Word	Low Order Time Word

Figure 11-4. Secondary Header Chapter 4 Time

When IEEE 1588 time is used time shall be stored as shown in [Figure 11-5](#).

msb	lsb
31	0
Nanoseconds Word	
Seconds Word	

Figure 11-5. Secondary Header IEEE 1588 Time

When ERTC time is used time shall be stored as shown in [Figure 11-6](#).

msb	lsb
31	0
LSLW	
MSLW	

Figure 11-6. Secondary Header ERTC Time

- b. Reserved. These 2 bytes are reserved and shall be zero filled.
- c. Secondary Header Checksum. These 2 bytes contain a value representing a 16-bit arithmetic sum of all secondary header bytes excluding the secondary header checksum word.

### 11.2.1.3 Packet Body, Version 1

The format of the data in the packet body is unique to each data type. Detailed descriptions of the type-specific data formats found in packet bodies are described in subsequent sections of this document.

- a. Channel-Specific Data. Variable in size, this contains the contents of the channel-specific data field(s) depending on the Data Type field in the packet header. Channel-specific data is mandatory for each data type and channel. The occurrence of channel-specific data is once per packet and precedes packet channel data.
- b. Intra-Packet Time Stamp. These 8 bytes contain time in either 48-bit RTC format (plus 16 high-order zero bits) or 64-bit format as specified in the packet flags in the packet header. The IPTSs are only mandatory where defined by the data formats.
- c. Intra-Packet Data Header. Variable in size, this contains additional time status, data, and/or format information pertaining to the data items that follow. The IPDHs are only mandatory where defined by the data formats.
- d. Data. With n bytes, this contains valid data from a particular channel as defined within the data formats contained within this standard.

	<p><b>NOTE</b> The IPTS and the IPDH are collectively called the IPH. In some cases, an IPH may only have a timestamp (zero-length data header), while in other cases, the IPH only has a data header (zero-length timestamp). Some data types have no IPH. The IPH requirements are specified separately for each datatype.</p>
---	--

	<p><b>NOTE</b> The IPDH presence, once set, shall be the same state for the entire session (e.g., recording) per each channel</p>
---	---

### 11.2.1.4 Packet Trailer, Version 1

The packet trailer may contain filler, a data checksum, both filler and a data checksum, or neither filler nor a data checksum. In the latter case, the packet trailer has zero length. The reason a packet trailer would have a zero length is best explained by understanding the reason for inserting filler. The purpose of the filler is twofold:

- a. To keep all packets aligned on 32-bit boundaries (i.e., make all packet lengths a multiple of 4 bytes); and
- b. To optionally keep all packets from a particular channel the same length.

If both of the above requirements are already met without adding filler, then filler shall not be added.

The inclusion of the data checksum is optional as well and is indicated by the packet flags setting. When included, the packet trailer contains either an 8-bit, 16-bit, or 32-bit data checksum. Depending on the packet flags option selected, the data checksum is the arithmetic sum of all of the bytes (8 bits), words (16 bits), or long words (32 bits) in the packet excluding the 24 bytes of packet header, packet secondary header (if enabled), and the data checksum. Stated another way, the data checksum includes everything in the packet body plus all added filler.

- a. Filler. Variable in size, all filler shall be set to 0x00 or 0xFF.
- b. 8-Bit Data Checksum. This 1 byte contains a value representing an 8-bit arithmetic sum of the bytes in the packet. It is only inserted if the packet flag bits are set (see Subsection [11.2.1.1](#) item g).
- c. 16-Bit Data Checksum. These 2 bytes contain a value representing a 16-bit arithmetic sum of the words in the packet. It is only inserted if the packet flag bits are set (Subsection [11.2.1.1](#) item g).
- d. 32-Bit Data Checksum. These 4 bytes contain a value representing a 32-bit arithmetic sum of the long words in the packet and is only inserted if packet flag bits are set (Subsection [11.2.1.1](#) item g).

11.2.1.5 Version 2 Packet Header (Proposed)



 <p><b>NOTE</b></p>	<p>The next release of this standard will document a new header. This will be a version 2 header. The current header will continue to be supported and maintained.</p>
--	--

11.2.2 PCM Data Packets

11.2.2.1 PCM Data Packets Format 0  
Reserved.

11.2.2.2 PCM Data Packets Format 1 (Chapter 4 and Chapter 8)

A packet with Chapter 4 or Chapter 8 PCM data has the basic structure as shown in [Table 11-5](#). Note that the width of the structure is not related to any number of bits. This table merely represents relative placement of data in the packet.

<b>Table 11-5. General PCM Data Packet, Format 1</b>	
Packet Header	
Channel-Specific Data	
	(Optional) Intra-Packet Time Stamp
	(Optional) Intra-Packet Data Header
Minor Frame Data	
	(Optional) Intra-Packet Time Stamp
	(Optional) Intra-Packet Data Header
Minor Frame Data	
	(Optional) Intra-Packet Time Stamp
	(Optional) Intra-Packet Data Header
Minor Frame Data	
	(Optional) Intra-Packet Time Stamp
	(Optional) Intra-Packet Data Header
Minor Frame Data	
	:
	(Optional) Intra-Packet Time Stamp

(Optional) Intra-Packet Data Header
Minor Frame Data
Packet Trailer

The user may separately enable or disable word unpacking on each active PCM channel. Word unpacking will force the lsb of each word to be aligned on a 16-bit boundary. High-order filler bits are added to words as necessary to force alignment.

The user may separately enable or disable frame synchronizing on each active PCM channel. This provides a throughput mode that will transfer data to the packet without frame synchronization. Throughput mode essentially disables all setup and packing/unpacking options for the packet, and places data in the packet as it is received.

- a. PCM Packet Channel-Specific Data. The packet body portion of each PCM packet begins with the channel-specific data, which is formatted as shown in [Figure 11-7](#).

msb										lsb
31	30	29	28	27	24	23	18	17	0	
R	IPH	MA	MI	LOCKST			MODE		SYNCOFFSET	

Figure 11-7. Pulse Code Modulation Packet Channel-Specific Data Format

- Reserved. Bit 31 is reserved.
- Intra-Packet Header. Bit 30 indicates if IPHs (IPTS and IPDH) are inserted before each minor frame. The IPHs are only optional because of the mode selection. This determines whether IPHs are included or omitted.
  - 0 = The IPHs are omitted for throughput mode.
  - 1 = The IPHs are required for packed data and unpacked data modes.
- Major Frame Indicator (MA). Bit 29 indicates if the first word in the packet is the beginning of a major frame. This bit is not applicable for throughput mode.
  - 0 = The first word is not the beginning of a major frame.
  - 1 = The first word is the beginning of a major frame.
- Minor Frame Indicator (MI). Bit 28 indicates if the first word in the packet is the beginning of a minor frame. This bit is not applicable for throughput mode.
  - 0 = The first word is not the beginning of a minor frame.
  - 1 = The first word is the beginning of a minor frame.
- Lock Status (LOCKST). Bits 27-24 indicate the lock status of the frame synchronizer. This bit is not applicable for throughput mode.

	<p><b>NOTE</b> Minor Frame Definition. The minor frame is defined as the data structure in time sequence from the beginning of a minor frame synchronization pattern to the beginning of the next minor frame synchronization pattern. Please refer to <a href="#">Chapter 4</a>, Subsection 4.3.2 for minor/major frame definition.</p>
---	--

Bits 27-26: Indicate minor frame status.

00 = Reserved.  
01 = Reserved.  
10 = Minor frame check (after losing lock).  
11 = Minor frame lock.

Bits 25-24: Indicate major frame status.

00 = Major frame not locked.  
01 = Reserved.  
10 = Major frame check (after losing lock).  
11 = Major frame lock.

- Mode (MODE). Bits 23-18 indicate the data packing mode.

Bits 23-22: Reserved.

Bit 21: Alignment Mode.

0 = 16-bit alignment mode enabled.  
1 = 32-bit alignment mode enabled.

Bit 20: Indicates throughput data mode.

0 = Throughput data mode not enabled.  
1 = Throughput data mode enabled.

Bit 19: Indicates packed data mode.

0 = Packed data mode not enabled.  
1 = Packed data mode enabled.

Bit 18: Indicates unpacked data mode.

0 = Unpacked data mode not enabled.  
1 = Unpacked data mode enabled.

- Sync Offset (SYNCOFFSET). Bits 17-0 contain an 18-bit binary value representing the word offset into the major frame for the first data word in the packet. The sync offset is not applicable for packed or throughput mode.

- b. PCM Packet Body. After the channel-specific data, the IPHs and the PCM data are inserted in the packet in integral numbers of minor or major frames unless the packet is in throughput mode. In throughput mode, there is no frame or word alignment to the packet data and no IPHs are inserted in the data. In both packed and unpacked modes, minor frame alignment is dependent on the MODE field in the channel-specific data. In 16-bit alignment mode, PCM minor frames begin and end on 16-bit boundaries. In 32-bit alignment mode, PCM minor frames begin and end on 32-bit boundaries. In either case, alignment mode does not affect the format of PCM data words themselves; however, depending on perspective, word order is affected and a zero-filled data word may be required to maintain alignment.
- c. PCM Data in Unpacked Mode. In unpacked mode, packing is disabled and each data word is padded with the number of filler bits necessary to align the first bit of each word with the next 16-bit boundary in the packet. For example, 4 pad bits are added to 12-bit words, 6 pad bits are added to 10-bit words, etc. In 32-bit alignment mode, a zero-filled

16-bit word is required to maintain alignment when an odd number of 16-bit words exists in the minor frame.

Minor frame sync patterns larger than 16 bits are divided into two words of packet data. If the sync pattern has an even number of bits, then it will be divided in half and placed in two packet words. For example, a 24-bit sync pattern is broken into two 12-bit words with 4 bits of pad in each word. If the sync pattern has an odd number of bits, it is broken into two words with the second word having one bit more of the sync pattern. For example, if the minor sync pattern is 25 bits, then the first sync word is 12 bits of sync pattern plus 4 bits of pad, and the second sync word is 13 bits of sync pattern plus 3 bits of pad.

Minor frame sync patterns larger than 32 bits are divided into  $(\text{number of bits}+15)/16$  words in 16-bit alignment mode or  $(\text{number of bits}+31)/32$  in 32-bit alignment mode. If the sync word doesn't fill the words completely, the first word shall contain the lesser number of bits with the later words containing one bit more (in the manner described above in splitting frame sync pattern words into two words). For example, a 35-bit sync word shall be split into 11+12+12-bit words in 16-bit alignment mode, or into 17+18-bit words in 32-bit alignment mode.

Given PCM frames with a 24-bit minor sync pattern and  $n$  data words where the bit-lengths of data words 1, 2, and 3 are 12, 16, and 8 respectively, the resultant 16-bit alignment mode PCM packets are as shown in [Table 11-6](#). Given PCM frames with a 24-bit minor sync pattern and  $n$  data words where the bit-lengths of data words 1, 2, 3, and 4 are 12, 16, 8, and 10 respectively, the resultant 32-bit alignment mode PCM packets are as shown in [Table 11-7](#).

<b>Table 11-6. PCM Data-Unpacked (16-Bit Alignment Mode) Sample Packet</b>	
msb	lsb
15	0
<b>Packet Header</b>	
Channel-Specific Data (Bits 15-0)	
Channel-Specific Data (Bits 31-16)	
Intra-Packet Time Stamp (Bits 15-0)	
Intra-Packet Time Stamp (Bits 31-16)	
Intra-Packet Time Stamp (Bits 47-32)	
Intra-Packet Time Stamp (Bits 63-48)	
Intra-Packet Data Header (Bits 15-0)	
4 Bits Pad	12 Bits Sync (Bits 23-12)
4 Bits Pad	12 Bits Sync (Bits 11-0)
4 Bits Pad	12 Bits Word 1 Data
16 Bits Word 2 Data	
8 Bits Pad	8Bits Word 3 Data
:	
Word N Data Bits + Pad if Needed	
Intra-Packet Time Stamp (Bits 15-0)	

Intra-Packet Time Stamp (Bits 31-16)
Intra-Packet Time Stamp (Bits 47-32)
Intra-Packet Time Stamp (Bits 63-48)
Intra-Packet Data Header (Bits 15-0)
:
Repeat for each minor frame.
:
Packet Trailer

<b>Table 11-7. PCM Data-Unpacked (32-Bit Alignment Mode) Sample Packet</b>	
msb	lsb
15	0
Packet Header	
Channel-Specific Data (Bits 15-0)	
Channel-Specific Data (Bits 31-16)	
Intra-Packet Time Stamp (Bits 15-0)	
Intra-Packet Time Stamp (Bits 31-16)	
Intra-Packet Time Stamp (Bits 47-32)	
Intra-Packet Time Stamp (Bits 63-48)	
Intra-Packet Data Header (Bits 15-0)	
Intra-Packet Data Header (Bits 31-16)	
4 Bits Pad	12 Bits Sync (Bits 11-0)
4 Bits Pad	12 Bits Sync (Bits 23-12)
16 Bits Word 2 Data	
4 Bits Pad	12 Bits Word 1 Data
6 Bits Pad	10 Bits Word 4 Data
8 Bits Pad	8 Bits Word 3 Data
:	
Word N Data Bits + Pad If Needed	
Intra-Packet Time Stamp (Bits 15-0)	
Intra-Packet Time Stamp (Bits 31-16)	
Intra-Packet Time Stamp (Bits 47-32)	
Intra-Packet Time Stamp (Bits 63-48)	
Intra-Packet Data Header (Bits 15-0)	
Intra-Packet Data Header (Bits 31-16)	
:	
Repeat for each minor frame.	
:	
Packet Trailer	

- d. PCM Data in Packed Mode. In packed mode, packing is enabled and pad is not added to each data word; however, filler bits may be required to maintain minor frame alignment.



The number of filler bits is dependent on the alignment mode, where N is either 16 or 32. If the number of bits in the minor frame is not an integer multiple of N, then Y pad bits will be added to the end of each minor frame of bit length L. Either  $Y = N - \text{MOD}(L, N)$ , or N minus the integer remainder when L is divided by N. In packed mode, the PCM stream is minor-frame synchronized so the first data bit in the packet is the first data bit of a minor frame. If  $X = N - Y$  when N is 16-bit alignment mode, then the resultant PCM packets are as shown in [Table 11-8](#). [Table 11-9](#) shows the resultant PCM packets for 32-bit alignment mode.

<b>Table 11-8. PCM Data-Packed (16-Bit Alignment Mode)</b>	
<b>Sample Packet</b>	
msb	lsb
15	0
Packet Header	
Channel-Specific Data (Bits 15-0)	
Channel-Specific Data (Bits 31-16)	
Intra-Packet Time Stamp (Bits 15-0)	
Intra-Packet Time Stamp (Bits 31-16)	
Intra-Packet Time Stamp (Bits 47-32)	
Intra-Packet Time Stamp (Bits 63-48)	
Intra-Packet Data Header (Bits 15-0)	
Data (Bits 15-0)	
Data (Bits 31-16)	
Data (Bits 47-32)	
:	
Y Filler Bits	X Data Bits
Intra-Packet Time Stamp (Bits 15-0)	
Intra-Packet Time Stamp (Bits 31-16)	
Intra-Packet Time Stamp (Bits 47-32)	
Intra-Packet Time Stamp (Bits 63-48)	
Intra-Packet Data Header (Bits 15-0)	
:	
Repeat for each minor frame.	
:	
Packet Trailer	

<b>Table 11-9. PCM Data-Packed (32-Bit Alignment Mode)</b>	
<b>Sample Packet</b>	
msb	lsb
15	0
Packet Header	
Channel-Specific Data (Bits 15-0)	
Channel-Specific Data (Bits 31-16)	

Intra-Packet Time Stamp (Bits 15-0)	
Intra-Packet Time Stamp (Bits 31-16)	
Intra-Packet Time Stamp (Bits 47-32)	
Intra-Packet Time Stamp (Bits 63-48)	
Intra-Packet Data Header (Bits 15-0)	
Intra-Packet Data Header (Bits 31-16)	
Data Word 2	
Data Word 1	
Data Word 4	
Data Word 3	
:	
Filler Bits	X Data Bits
16 Filler Bits (If Required to Maintain 32-Bit Alignment)	
Intra-Packet Time Stamp (Bits 15-0)	
Intra-Packet Time Stamp (Bits 31-16)	
Intra-Packet Time Stamp (Bits 47-32)	
Intra-Packet Time Stamp (Bits 63-48)	
Intra-Packet Data Header (Bits 15-0)	
Intra-Packet Data Header (Bits 31-16)	
:	
Repeat for each minor frame.	
:	
Packet Trailer	

- e. PCM Data in Throughput Mode. In throughput mode, the PCM data are not frame synchronized so the first data bit in the packet can be any bit in the major frame. The resultant PCM packets are as shown in [Table 11-10](#) and [Table 11-11](#).

<b>Table 11-10. PCM Data-Throughput (16-Bit Alignment Mode) Sample Packet</b>	
msb	lsb
15	0
Packet Header	
Channel-Specific Data (Bits 15-0)	
Channel-Specific Data (Bits 31-16)	
Data (Bits 15-0)	
Data (Bits 31-16)	
Data (Bits 47-32)	
:	
Packet Trailer	

<b>Table 11-11. PCM Data-Throughput (32-Bit Alignment Mode) Sample Packet</b>	
msb	lsb
15	0
Packet Header	
Channel-Specific Data (Bits 15-0)	
Channel-Specific Data (Bits 31-16)	
PCM Stream Bits 17-32	
PCM Stream Bits 1-16	
PCM Stream Bits 49-64	
PCM Stream Bits 33-48	
:	
Packet Trailer	

- f. PCM Data Word Order in 32-Bit Alignment Mode. When acquitting data in 32-bit alignment mode, the resultant data word ordering will differ from 16-bit alignment mode. The serial PCM data stream is shifted into 32-bit words from right to left, with bit 31 on the left, bit 0 on the right, and addresses ascending from top to bottom. Word order is affected depending on the reader’s addressing perspective. For example, 16-bit data words when addressed as 32-bit words appear in order when read from left to right and top to bottom; however, when addressed as 16-bit words, each pair of data words will appear swapped. [Figure 11-8](#) and [Figure 11-9](#) depict the anomaly of perspective.

msb				lsb	Address
31	16	15		0	
Byte 3	Byte 2	Byte 1	Byte 0		
Data Word 1		Data Word 2		0	
Data Word 3		Data Word 4		1	
:					
Data Word N-1		Data Word N		(N/2)-1	

Figure 11-8. 32-Bit Alignment Mode Example, 16-Bit Data Words (32-Bit Word Addressing)

msb			lsb	Address
15			0	
Byte 1		Byte 0		
Data Word 2				0
Data Word 1				1
Data Word 4				2
Data Word 3				3
:				
Data Word N-1				N-1

Figure 11-9. 32-Bit Alignment Mode Example, 16-Bit Data Words (16-Bit Word Addressing)

- g. PCM Intra-Packet Header. When acquiring data in packed or unpacked mode, all PCM minor frames shall include an IPH containing a 64-bit IPTS and a 16- or 32-bit IPDH, as indicated by MODE in the channel-specific data. This header is inserted immediately before the minor frame sync pattern. Depending on alignment mode, the length of the IPH is either 10 or 12 bytes (80 or 96 bits) positioned contiguously, as depicted in [Figure 11-10](#). In 16-bit alignment mode, the IPDH length is fixed at 2 bytes. A 32-bit alignment mode requires a 4-byte IPDH, and the two most significant bytes are zero-filled.

msb	lsb
31	0
16 15	12 11
Time (LSLW)	
Time (MSLW)	
Zero Filled	LOCKST
	RESERVED

Figure 11-10. Pulse Code Modulation Intra-Packet Header

- Intra-Packet Time Stamp. These 8 bytes indicate the time tag of the PCM minor frame. This time stamp is not applicable for throughput mode. First long word bits and second long word bits indicate the following values:
  - The 48-bit RTC that corresponds to the first data bit of the minor frame with bits 31 to 16 in the second long word zero-filled; or
  - Absolute time, if enabled by bit 6 in the packet flags (Subsection [11.2.1.1](#) item [g](#)). The time format is indicated by bits 2 and 3 in the packet flags (Subsection [11.2.1.1](#) item [g](#)). The time tag shall be correlated to the first data bit of the minor frame.
- Intra-Packet Data Header
  - 32-Bit Alignment (32-Bit Alignment mode ONLY). Bits 31-16 are zero-filled.
  - Lock Status (LOCKST). Bits 15-12 indicate the lock status of the frame synchronizer for each minor frame.
  - Bits 15-14: Indicates minor frame status.
    - 00 = Reserved
    - 01 = Reserved
    - 10 = Minor frame check (after losing lock)
    - 11 = Minor frame lock
  - Bits 13-12: Indicates major frame status.
    - 00 = Major frame not locked
    - 01 = Reserved
    - 10 = Major frame check (after losing lock)
    - 11 = Major frame lock
  - Reserved. Bits 11-0 are reserved.

### 11.2.2.3 PCM Data Packets Format 2 (DQE)

A PCM Data Packet, Format 2 provides a known method of capturing throughput PCM (Chapter 4, 7, or 8) with inserted Data Quality Encapsulation (DQE). The basic structure is

shown in [Table 11-12](#). Note that the width of the structure is not related to any number of bits. This table merely represents relative placement of data in the packet.

<b>Table 11-12. General PCM Data Packet, Format 2</b>	
Packet Header	
Channel-Specific Data Word	
DQE Header	
DQM PCM Payload	
DQE Header	
DQM PCM Payload	
:	
DQE Header	
DQM PCM Payload	
Packet Trailer	

The telemetry receiver/demodulator determines and inserts the DQE protocol IAW [Chapter 2](#), Appendix 2-G.

- a. PCM Data Packet, Format 2 Channel-Specific Data. The packet body portion of each PCM packet begins with the channel-specific data, which is formatted as shown in [Figure 11-11](#).

msb							lsb		
31	26	25	24	23	20	19	16	15	0
RESERVED		A	STC	LDPC-B		LDPC-R		DQE PAYLOAD SIZE	

Figure 11-11. DQE PCM Channel-Specific Data, Format 2

- RESERVED. Bits 31-26 are reserved.
- A. Bit 25 indicates alignment mode.
  - 0 – 16-bit alignment mode enabled
  - 1 – 32-bit alignment mode enabled
- STC. Bit 24 indicates Chapter 2 Space Time Code (STC) enabled/disabled.
  - 0 – STC Disabled
  - 1 – STC Enabled
- LDPC-B. Bits 23-20 indicate Chapter 2 LDPC block size.
  - 0000 – LDPC Disabled
  - 0001 – 1024
  - 0010 – 4096
  - 0011-1111 – Reserved
- LDPC-R. Bits 19-16 indicate Chapter 2 Low Density Parity Check (LDPC) code rate.
  - 0000 – LDPC Disabled
  - 0001 – Code Rate 1/2



- 0010 – Code Rate 2/3
- 0011 – Code Rate 4/5
- 0100-1111 – Reserved

- **DQE PAYLOAD SIZE.** Bits 15-0 contain a 16-bit binary value representing the DQE payload size IAW [Chapter 2](#). The payload size is in bits: 1024 minimum/16,384 maximum. Payload size can be any multiple of 32 bits between the minimum and maximum sizes.
- b. **PCM Data Packets, Format 2 Body.** After the channel-specific data, the PCM DQE data are inserted in the packet IAW [Chapter 2](#) followed by a packet trailer.
- c. **Data Alignment.** The DQE data contains a 24-bit header followed by a payload of 1024-16,384 bits. The payload length is always divisible by 32 bits; therefore, the DQE data will always be aligned to a 16-bit boundary, but never on a 32-bit value as shown in [Table 11-13](#). For 32-bit alignment mode only, 16 bits of padding shall be inserted prior to the start of the DQE data as shown in [Table 11-14](#). The padding bits shall all be 0's.



<b>Table 11-13. Data (16-Bit Alignment Mode) Sample Packet, Format 2</b>	
msb	lsb
15	0
Packet Header	
Channel-Specific Data (Bits 15-0)	
Channel-Specific Data (Bits 31-16)	
DQE Sync Word (Bits 15-0)	
DQE RSV (Bits 11-0)	DQE VER (Bits 3-0)
DQE DQM (Bits 15-0)	
DQE Payload (Bits 15-0)	
DQE Payload (Bits 31-16)	
:	
DQE Sync Word (Bits 15-0)	
DQE RSV (Bits 11-0)	DQE VER (Bits 3-0)
DQE DQM (Bits 15-0)	
DQE Payload (Bits 15-0)	
DQE Payload (Bits 31-16)	
:	
Repeat for Each DQE data “frame”	
:	
Packet Trailer	



<b>Table 11-14. PCM Data (32-Bit Alignment Mode) Sample Packet, Format 2</b>	
msb	lsb
15	0
<b>Packet Header</b>	
Channel-Specific Data (Bits 15-0)	
Channel-Specific Data (Bits 31-16)	
DQE Sync Word (Bits 15-0)	
32-bit Alignment Padding (Bits 15-0)	
DQE DQM (Bits 15-0)	
DQE RSV (Bits 11-0)	DQE VER (Bits 3-0)
DQE Payload (Bits 31-16)	
DQE Payload (Bits 15-0)	
DQE Payload (Bits 63-48)	
DQE Payload (Bits 47-32)	
:	
DQE Sync Word (Bits 15-0)	
32-bit Alignment Padding (Bits 15-0)	
DQE DQM (Bits 15-0)	
DQE RSV (Bits 11-0)	DQE VER (Bits 3-0)
DQE Payload (Bits 31-16)	
DQE Payload (Bits 15-0)	
DQE Payload (Bits 63-48)	
DQE Payload (Bits 47-32)	
:	
Repeat for Each DQE data “frame”	
:	
<b>Packet Trailer</b>	

- d. Frame Alignment. The DQE frames are frame-aligned within the PCM Format 2 packets.

11.2.3 Time Data Packets

11.2.3.1 Time Data Packets, Format 0. Reserved.

11.2.3.2 Time Data Packets, Format 1 (IRIG/GPS/RTC)

Time is treated like another data channel. If a time source other than NONE is used ([Figure 11-12](#)), the time packet will be generated at a minimum frequency of 1 hertz.

msb									lsb	
31		16	15	12	11	8	7	4	3	0
Reserved			ITS		DATE		FMT	SRC		

Figure 11-12. Time Packet Channel-Specific Data Format



- Inter-Range Instrumentation Group (IRIG) Time Type Formats. The 10-MHz RTC shall be captured for insertion into the time packet data header IAW IRIG 200.<sup>2</sup>
- All Non-IRIG Time Type Formats. The 10-MHz RTC shall be captured for insertion into the time packet data header consistent with the resolution with the time packet body format (10 milliseconds [ms] as measured by the 10-MHz RTC).

 <p><b>NOTE</b></p>	<p>A time data packet shall be the first dynamic data packet at the start of each session. Only static Computer-Generated Data, Format 1 packets may precede the first time data packet.</p>
--	--

 <p><b>NOTE</b></p>	<p>If the time data packet source is None, at least one time data packet is required IAW the previous note.</p>
--	---

A packet with time data has the basic structure shown in [Table 11-15](#). Note that the width of the structure is not related to any number of bits. This drawing is merely to represent relative placement of data in the packet. Time packets do not have IPHs.

<b>Table 11-15. General Time Data Packet, Format 1</b>
Packet Header
Channel-Specific Data
Time Data
Packet Trailer

- a. Time Packet Channel-Specific Data. The packet body portion of each time data packet begins with a CSDW formatted as shown in [Figure 11-12](#).
  - Reserved. Bits 31-16 are reserved.
  - IRIG Time Source (ITS). Bits 15-12 provide dynamic information regarding the source of time for an internal IRIG time code generator (TCG) when FMT is IRIG-A, B, or G. The ITS bits can toggle depending upon quality/validity of sources.
    - 0000 = IRIG TCG freewheeling (no or loss of time source)
    - 0001 = IRIG TCG freewheeling from .TIME command
    - 0010 = IRIG TCG freewheeling from RMM time
    - 0011 = IRIG TCG locked to external IRIG time signal
    - 0100 = IRIG TCG locked to external GPS
    - 0101 = IRIG TCG locked to external Network Time Protocol (NTP)
    - 0110 = IRIG TCG locked to external Precision Time Protocol (PTP)
    - 0111 = IRIG TCG locked to external embedded time from input track/channel such as PCM or MIL-STD-1553
    - 1000-1111 = Reserved

<sup>2</sup> Range Commanders Council. *IRIG Serial Time Code Formats*. RCC 200-16. August 2016. May be superseded by update. Retrieved 17 May 2021. Available at <https://www.trmc.osd.mil/wiki/x/wou8Bg>.



- **Date (DATE).** Bits 11-8 indicate the date format. All bit patterns not used to define a date format type are reserved for future growth.
  - Bits 11-10: Reserved.
  - Bit 9: Indicates date format.
    - 0 = IRIG day available ([Figure 11-13](#))
    - 1 = Month and year available ([Figure 11-14](#))

msb										lsb																																		
15					14					12					11					8					7					4					3					0				
0					TSn					Sn					Hmn					Tmn																								
0					0					THn					Hn					0					TMn					Mn														
0					0					0					0					0					0					HDn					TDn					Dn				

Figure 11-13. Time Data-Packet Format, Day Format

msb										lsb																																		
15					14					12					11					8					7					4					3					0				
0					TSn					Sn					Hmn					Tmn																								
0					0					THn					Hn					0					TMn					Mn														
0					0					0					Ton					On					TDn					Dn														
0					0					OYn					HYn					TYn					Yn																			

Figure 11-14. Time Data-Packet Format, Day, Month, and Year Format

- Bit 8: Indicates if this is a leap year.
  - 0 = Not a leap year
  - 1 = Is a leap year
- **Time Format (FMT).** Bits 7-4 indicate the time data packet format.
  - 0x0 = IRIG-B
  - 0x1 = IRIG-A
  - 0x2 = IRIG-G
  - 0x3 = Real-Time Clock
  - 0x4 = Universal Coordinated Time (UTC) time from GPS
  - 0x5 = Native GPS Time
  - 0x6 – 0xE = Reserved
  - 0xF = NONE (time packet payload invalid)
- **Time Source (SRC).** Bits 3-0 indicate the source of the time in the payload of each time packet.
  - 0x0 = Internal (time derived from a clock in the recorder)
  - 0x1 = External (time derived from a clock not in the recorder)
  - 0x2 = Internal from RMM (time derived from the clock in the RMM)
  - 0x3 – 0xE = Reserved
  - 0xF = None

 <p><b>NOTE</b></p>	<p>If the time source is external (0x1) and lock on the external source is lost then the time source shall indicate Internal (0x0). Once lock on the external time source is regained, time source shall once again indicate external (0x1).</p>
--	--

- b. Time Packet Body. After the CSDW, the time data words are inserted in the packet in binary-coded decimal format as shown in [Figure 11-13](#) and [Figure 11-14](#) (units of measure presented in [Table 11-16](#)).

<b>Table 11-16. Units of Measure</b>			
Tmn	Tens of ms	TDn	Tens of days
Hmn	Hundreds of ms	HDn	Hundreds of days
Sn	Units of seconds	On	Units of months
TSn	Tens of Seconds	TOn	Tens of months
Mn	Units of minutes	Yn	Units of years
TMn	Tens of minutes	TYn	Tens of years
Hn	Units of hours	HYn	Hundreds of years
THn	Tens of hours	OYn	Thousands of years
Dn	Units of days	0	Always zero

11.2.3.3 Time Data Packets, Format 2 (Network Time)

The Format 2 Network Time packet data type is used to extract and encapsulate absolute time from NTP or IEEE-1588 PTP and time tag it with the RTC. The Format 2 Network Time packet will be generated at a minimum frequency of 1 hertz unless it is recorded at the raw network rate of the NTP or PTP frames.

The NTP is referenced in UTC time with an epoch of January 1, 1900. The NTP time includes leap seconds.

The PTP is referenced in International Atomic Time with an epoch of January 1, 1970. The PTP time does not include leap seconds.

 <p><b>NOTE</b></p>	<p>A time data packet shall be the first dynamic data packet at the start of each recording. Only static Computer-Generated Data, Format 1 packets may precede the first time data packet in the recording.</p>
--	---

The Format 2 Network Time packet has the basic structure shown in [Table 11-17](#). Note that the width of the structure is not related to any number of bits. This drawing is merely to represent relative placement of data in the packet. Format 2 Network Time packets do not have IPHs.

<b>Table 11-17. General Time Data Packet, Format 1</b>
Packet Header
Channel-Specific Data

Time Data
Packet Trailer

- a. Time Packet Channel-Specific Data. The packet body portion of each time data packet begins with a CSDW formatted as shown in [Figure 11-15](#).

msb					lsb
31		8	7	4	3
Reserved			NTF		TS

Figure 11-15. Format 2 Network Time Packet Channel-Specific Data Format

- Reserved. Bits 31-8 are reserved.
- Network Time Format (NTF). Bits 7-4 indicate the time data packet format.
  - 0x0 = Network Time Protocol Version 3 (Request for Comment 1305<sup>3</sup>).
  - 0x1 = IEEE-1588-2002
  - 0x2 = IEEE-1588-2008
  - 0x3 – 0xF = Reserved
- Time Status (TS). Bits 3-0 indicate the status of the network time.
  - 0x0 = Time Not Valid
  - 0x1 = Time Valid
  - 0x2 – 0xF = Reserved

- b. Time Packet Body. After the CSDW, the time data is inserted in the packet as shown in [Figure 11-16](#) for NTP and [Figure 11-17](#) for PTP.

msb	lsb
31	0
Time Unsigned Seconds	
Time Unsigned Seconds Fractions	

Figure 11-16. Format 2 Network Time Packet NTP Time Data

msb	lsb
31	0
Time Unsigned Seconds	
Time Unsigned Nanoseconds	

Figure 11-17. Format 2 Network Time Packet PTP Time Data

## 11.2.4 MIL-STD-1553 Packets

### 11.2.4.1 MIL-STD-1553 Bus Data Packets, Format 0.

Reserved.

<sup>3</sup> Internet Engineering Task Force. "Network Time Protocol (Version 3) Specification, Implementation and Analysis." RFC 1305. March 1992. Obsolete by RFC 5905. Retrieved 17 May 2021. Available at <https://datatracker.ietf.org/doc/rfc1305/>.

11.2.4.2 MIL-STD-1553 Bus Data Packets, Format 1 (MIL-STD-1553B Bus Data)

Data in the MIL-STD-1553 bus format is packetized as messages, with each 1553 bus transaction recorded as a message. A transaction is a bus controller (BC)-to-remote terminal (RT), RT-to-BC, or RT-to-RT word sequence, starting with the command word and including all data and status words that are part of the transaction, or a mode code word broadcast. Multiple messages may be encoded into the data portion of a single packet.

- a. MIL-STD-1553 Packet Channel-Specific Data. The packet body portion of each MIL-STD-1553 data packet begins with a CSDW formatted as shown in [Figure 11-18](#).

msb									lsb
	31	30	29	24	23	22	21	20	0
TTB	RESERVED			MSGCOUNT					

Figure 11-18. MIL-STD-1553 Packet Channel-Specific Data Format

- Time Tag Bits (TTB). Bits 31-30 indicate which bit of the MIL-STD-1553 message the IPH time tags.
    - 00 = Last bit of the last word of the message
    - 01 = First bit of the first word of the message
    - 10 = Last bit of the first (command) word of the message
    - 11 = Reserved
  - Reserved. Bits 29-24 are reserved.
  - Message Count (MSGCOUNT). Bits 23-0 indicate the binary value of the number of messages included in the packet. An integral number of complete messages will be in each packet.
- b. MIL-STD-1553 Packet Body. A packet within MIL-STD-1553 messages has the basic structure shown in [Table 11-18](#). Note that the width of the structure is not related to any number of bits. This drawing is merely intended to represent relative placement of data in the packet.

<b>Table 11-18. MIL-STD-1553 Data Packet, Format 1 Basic Layout</b>	
<b>Packet Header</b>	
<b>Channel-Specific Data</b>	
Intra-Packet Time Stamp for Message 1	
Intra-Packet Data Header for Message 1	
<b>Message 1</b>	
Intra-Packet Time Stamp for Message 2	
Intra-Packet Data Header for Message 2	
<b>Message 2</b>	
:	
Intra-Packet Time Stamp for Message N	
Intra-Packet Data Header for Message N	

Message N
Packet Trailer

- c. MIL-STD-1553 Intra-Packet Header. After the channel-specific data, the MIL-STD-1553 data are inserted into the packet in messages. Each MIL-STD-1553 message is preceded by an IPH consisting of an IPTS and an IPDH.
- (1) MIL-STD-1553 Intra-Packet Time Stamp. These 8 bytes indicate the time tag of the MIL-STD-1553 message as follows.
    - The 48-bit RTC that corresponds to the data bit indicated in the MIL-STD-1553 channel-specific data, TTBs (Subsection [11.2.4.2](#) item [a](#)) with bits 31 to 16 in the second long word zero-filled; or
    - The absolute time, if enabled by bit 6 in the packet flags (Subsection [11.2.1.1](#) item [g](#)). The time format is indicated by bits 2 and 3 in the packet flags (Subsection [11.2.1.1](#) item [g](#)). The time tag shall be correlated to the data bit indicated in the MIL-STD-1553 channel-specific data, TTBs (Subsection [11.2.4.2](#) item [a](#)).
  - (2) MIL-STD-1553 Intra-Packet Data Header. The length of the IPDH is fixed at 6 bytes (48 bits) positioned contiguously, in the following sequence ([Figure 11-19](#)).

msb	lsb
15	0
Block Status Word	
Gap Times Word	
Length Word	

Figure 11-19. MIL-STD-1553 Intra-Packet Data Header

- Block Status Word (BSW). Bits 15-0 contain the block status word for both the message type and any 1553 bus protocol errors that occurred during the message transfer. The block status word bit definitions are in [Figure 11-20](#).

msb																	lsb
15	14	13	12	11	10	9	8		6	5	4	3	2				0
R		BID	ME	RR	FE	TM	RESERVED		LE	SE	WE	RESERVED					

Figure 11-20. Block Status Word

- Reserved (R). Bits 15-14 are reserved.
- Bus ID (BID). Bit 13 indicates the bus ID for the message.
  - 0 = Message was from channel A
  - 1 = Message was from channel B
- Message Error (ME). Bit 12 indicates a message error was encountered.
  - 0 = No message error
  - 1 = Message error

- RT to RT Transfer (RR). Bit 11 indicates a, RT to RT transfer; message begins with two command words.  
0 = No RT to RT transfer  
1 = RT to RT transfer
- Format Error (FE). Bit 10 indicates any illegal gap on the bus other than response timeout.  
0 = No format error  
1 = Format error
- Response Time Out (TM). Bit 9 indicates a response time out occurred. The bit is set if any of the status word(s) belonging to this message didn't arrive within the response time of 14 microseconds ( $\mu\text{s}$ ) defined by MIL-STD-1553B.<sup>4</sup>  
0 = No response time out  
1 = Response time out
- Reserved. Bits 8-6 are reserved.
- Word Count Error (LE). Bit 5 indicates that the number of data words transmitted is different than identified in the command word. A MIL-STD-1553B status word with the busy bit set to true will not cause a word count error. A transmit command with a response timeout will not cause a word count error.  
0 = No word count error  
1 = Word count error
- Sync Type Error (SE). Bit 4 indicates an incorrect sync type occurred.  
0 = No sync type error  
1 = Sync type error
- Invalid Word Error (WE). Bit 3 indicates an invalid word error occurred. This includes Manchester decoding errors in the sync pattern or word bits, invalid number of bits in the word, or parity error.  
0 = No invalid word error  
1 = Invalid word error
- Reserved. Bits 2-0 are reserved.

 <p><b>NOTE</b></p>	<p>Gap Times (response time): The gap times word indicates RT response times as defined by MIL-STD-1553. The resolution of the response time shall be in tenths of <math>\mu\text{s}</math>. A maximum of two response time words can exist. Messages of RT-to-RT type shall have two response time words if both terminals respond;</p>
--	--

<sup>4</sup> Department of Defense. "Aircraft Internal Time Division Command/Response Multiplex Data Bus." MIL-STD-1553B. 21 September 1978. Superseded by update 28 February 2018. Retrieved 17 May 2021. Available at [https://quicksearch.dla.mil/qsDocDetails.aspx?ident\\_number=36973](https://quicksearch.dla.mil/qsDocDetails.aspx?ident_number=36973).

	all other messages will have one response time word, or none for broadcast type messages or messages with no RT response.
--	---

- **Gap Times Word.** Bits 15-0 indicate the number of tenths of  $\mu\text{s}$  in length of the internal gaps within a single transaction. For most messages, only GAP1 is meaningful. It measures the time between the command or data word and the first (and only) status word in the message. For RT-to-RT messages, GAP2 measures the time between the last data word and the second status word. The gap times word bit definitions are as shown in [Figure 11-21](#).

msb		8	7		lsb
15					0
GAP2			GAP1		

Figure 11-21. Gap Times Word

<b>NOTE</b> 	Gap measurements shall be made IAW MIL-STD-1553 response time measurements from the mid-bit zero crossing of the parity bit of the last word to the mid-zero crossing of the sync of the status word.
--	---

- **Length Word.** Bits 15-0 contain the length of the message, which is the total number of bytes in the message. A message consists of command words, data words, and status words.
- d. **Packet Format.** Unless an error occurred, as indicated by one of the error flags in the block status word, the first word following the length word shall always be a command word. The resultant packets have the format shown in [Table 11-19](#).

<b>Table 11-19. MIL-STD-1553 Data Packet, Format 1</b>		
msb		lsb
15		0
Packet Header		
Channel-Specific Data (Bits 15-0)		
Channel-Specific Data (Bits 31-16)		
Intra-Packet Time Stamp for Msg 1 (Bits 15-0)		
Intra-Packet Time Stamp for Msg 1 (Bits 31-16)		
Intra-Packet Time Stamp for Msg 1 (Bits 47-32)		
Intra-Packet Time Stamp for Msg 1 (Bits 63-48)		
Intra-Packet Data Header for Msg 1 (Bits 15-0)		
Intra-Packet Data Header for Msg 1 (Bits 31-16)		
Intra-Packet Data Header for Msg 1 (Bits 47-32)		
Command Word		
Command, Status, or Data Word		
Data or Status Word		
:		
Data or Status Word		

Intra-Packet Time Stamp for Msg 2 (Bits 15-0)
Intra-Packet Time Stamp for Msg 2 (Bits 31-16)
Intra-Packet Time Stamp for Msg 2 (Bits 47-32)
Intra-Packet Time Stamp for Msg 2 (Bits 63-48)
Intra-Packet Data Header for Msg 2 (Bits 15-0)
Intra-Packet Data Header for Msg 2 (Bits 31-16)
Intra-Packet Data Header for Msg 2 (Bits 47-32)
Command Word
Command, Status, or Data Word
Data or Status Word
:
Data or Status Word
:
Intra-Packet Time Stamp for Msg N (Bits 15-0)
Intra-Packet Time Stamp for Msg N (Bits 31-16)
Intra-Packet Time Stamp for Msg N (Bits 47-32)
Intra-Packet Time Stamp for Msg N (Bits 63-48)
Intra-Packet Data Header for Msg N (Bits 15-0)
Intra-Packet Data Header for Msg N (Bits 31-16)
Intra-Packet Data Header for Msg N (Bits 47-32)
Command Word
Command or Data Word
Data or Status Word
:
Data or Status Word
Packet Trailer

#### 11.2.4.3 MIL-STD-1553 Bus Data Packets, Format 2 (Bus 16PP194 Weapons Bus Data)

This data type provides packetization for the F-16 MIL-STD-1553 weapons multiplex bus as defined in document 16PP362B.<sup>5</sup> A 16PP194 transaction consists of six each 32-bit words consisting of a 16PP194 COMMAND (1), COMMAND (1) ECHO, COMMAND (2), COMMAND (3) GO/NOGO, COMMAND (4) GO/NOGO, and STATUS as illustrated in [Figure 11-22](#). Multiple transactions may be encoded into the data portion of a single packet.

<sup>5</sup> Lockheed Martin Corporation. "Advanced Weapons Multiplex Data Bus." 8 June 2010. May be superseded by update. Retrieved 17 May 2021. Available to RCC members with Private Portal access at <https://www.trmc.osd.mil/wiki/x/xwTYBg>.



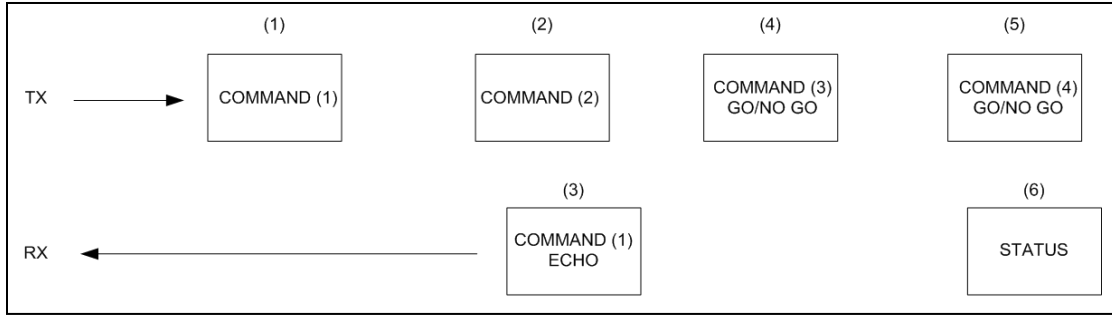

Figure 11-22. 16PP194 Message Transaction

- a. MIL-STD-1553 16PP194 Packet Channel-Specific Data Word. The packet body portion of each 16PP MIL-STD-1553 data packet begins with a CSDW formatted as shown in [Figure 11-23](#). Bits 31-0 indicate the binary value of the number of messages included in the packet. An integral number of complete transaction messages will be in each packet.

msb	lsb
31	0
MSGCOUNT	

Figure 11-23. Military Standard 1553 16PP194 Packet Channel-Specific Data Format

- b. MIL-STD-1553 16PP194 Packet Body. A packet with  $n$  MIL-STD-1553 16PP194 transactions has the basic structure shown in [Table 11-20](#) below. This drawing is merely to represent relative placement of data in the packet.

<b>Table 11-20. MIL-STD-1553 16PP194 Data Packet Basic Layout</b>	
msb	lsb
31	0
Packet Header	
16PP194 Channel-Specific Data Word	
Intra-Packet Time Stamp (LSLW)	
Intra-Packet Time Stamp (MSLW)	
Intra-Packet Data Header Length Word	Intra-Packet Data Header Status Word
Data 1	
.	
.	
Intra-Packet Time Stamp (LSLW)	
Intra-Packet Time Stamp (MSLW)	
Intra-Packet Data Header Length Word	Intra-Packet Data Header Status Word
Data N	
.	
.	
PACKET TRAILER	

c. MIL-STD-1553 16PP194 Intra-Packet Header. The IPH consists of the IPDH (LENGTH and STATUS) and the IPTS.

- MIL-STD-1553 16PP194 Intra-Packet Data Header LENGTH. The length word contains the length in bytes of the intra-packet data.

	<p>The intra-packet length is fixed to 0x18, 24 bytes.</p>
---	--

- MIL-STD-1553 16PP194 Intra-Packet Data Header STATUS. The status word contains error and special handling information about the data. When set to a “1”, the error indicator bits reflect that such an error is present in the data or occurred during data reception. The format of the status word is shown in [Figure 11-24](#).

msb										lsb									
15	14	13	12					7	6	5	4	3	2					0	
TE	RE	TM	RESERVED				SE	R	EE	RESERVED									

Figure 11-24. Military Standard 1553 16PP194 Intra-Packet Data Header Format

- Transaction Error (TE). Bit 15 indicates an error condition found in 16PP194 transaction.
  - 0 = No errors found in current transaction
  - 1 = Error condition found in transaction
- Reset (RE). Bit 14 indicates a 16PP194 bus master reset.
  - 0 = No master reset
  - 1 = Master reset assertion detected
- Message Time Out (TM). Bit 13 indicates a transaction time out occurred.
  - 0 = No message time out
  - 1 = Message time out
- Reserved. Bits 12-7 are reserved.
- Status Error (SE). Bit 6 indicates status word missing in transaction.
  - 0 = Status word present
  - 1 = Status word missing
- Reserved (R). Bits 5-4 are reserved.
- Echo Error (EE). Bit 3 indicates echo word missing in transaction.
  - 0 = Echo word present
  - 1 = Missing echo word
- Reserved. Bits 2-0 are reserved.

- MIL-STD-1553 16PP194 Intra-Packet Time Stamp. The IPTS (64 bits total) contains a 48-bit relative time stamp in the low-order bits. The 16 high-order bits are zero.
- d. Packet Format. Unless an error occurred, as indicated by one of the error flags in the IPDH, the first word following the length should always be the first transaction command word. The resultant packets have the format shown in [Table 11-21](#).

<b>Table 11-21. MIL-STD-1553 16PP194 Data Packet</b>	
msb	lsb
15	0
<b>Packet Header</b>	
Channel-Specific Data (Bits 15-0)	
Channel-Specific Data (Bits 31-16)	
Intra-Packet Time Stamp (Bits 0-15)	
Intra-Packet Time Stamp (Bits 31-16)	
Intra-Packet Time Stamp (Bits 32-47)	
Intra-Packet Time Stamp (Bits 48-63)	
Intra-Packet Data Header Status	
Intra-Packet Data Header Length	
Command (1) (Bits 31-16)	
Command (1)(Bits 15-0)	
Command (1) Echo(Bits 31-16)	
Command (1) Echo (Bits 15-0)	
Command (2) (Bits 31-16)	
Command (2) (Bits 15-0)	
Command (3) Go No-Go (Bits 31-16)	
Command (3) Go No-Go (Bits 15-0)	
Command (4) Go No-Go Echo (Bits 31-16)	
Command (4) Go No-Go Echo (Bits 15-0)	
Status (Bits 31-16)	
Status (Bits 15-0)	
Intra-Packet Time Stamp (Bits 0-15)	
Intra-Packet Time Stamp (Bits 31-16)	
Intra-Packet Time Stamp (Bits 32-47)	
Intra-Packet Time Stamp (Bits 48-63)	
Intra-Packet Data Header Status	
Intra-Packet Data Header Length	
Command (1) (Bits 31-16)	
Command (1) (Bits 15-0)	
Command (1) Echo (Bits 31-16)	
Command (1) Echo (Bits 15-0)	
Command (2) (Bits 31-16)	
Command (2) (Bits 15-0)	
Command (3) Go No-Go (Bits 31-16)	
Command (3) Go No-Go (Bits 15-0)	

Command (4) Go No-Go Echo (Bits 31-16)
Command (4) Go No-Go Echo (Bits 15-0)
Status (Bits 31-16)
Status (Bits 15-0)
Packet Trailer

- e. MIL-STD-1553 16PP194 Data Format. Each 26-bit 16PP194 word in a 16PP194 transaction shall be formatted into two 16-bit words ([Figure 11-25](#)). The corresponding 16PP194 sync and parity bits will not be formatted into the 16PP194 words.

msb								lsb
15	13	12	10	9	8	7		0
BUS ID		GAP		W	P	16PP194 Data Word (bits 24-17)		
16PP194 Data Word (bits 16-1)								

Figure 11-25. Military Standard 1553 26-Bit 16PP194 Word

- MIL-STD-1553 16PP194 Bus ID (BUS ID). A three-bit field shall be used to indicate bus identification as follows.

111	Communication interface unit (CIU) Left Bus A
110	CIU Left Bus B
101	CIU Right Bus A
100	CIU Right Bus B
011	Response Bus A and B
010	Response Bus A
001	Response Bus B
000	Incomplete Transaction

- MIL-STD-1553 16PP194 GAP (GAP). A three-bit field shall be used to indicate GAP between transactions as follows.

111	$GAP > 9.15 \mu s$
110	$7.55 \mu s < GAP \leq 9.15 \mu s$
101	$5.95 \mu s < GAP \leq 7.55 \mu s$
100	$4.35 \mu s < GAP \leq 5.95 \mu s$
011	$2.75 \mu s < GAP \leq 4.35 \mu s$
010	$2.75 \mu s < GAP \leq 4.35 \mu s$
001	$1.15 \mu s < GAP \leq 2.75 \mu s$
000	Not Applicable

 <p><b>NOTE</b></p>	<p>Gap time is measured from mid-crossing of the parity bit from the previous received word to mid-crossing of the sync bit of the current word in 1-<math>\mu s</math> counts.</p>
--	---

- MIL-STD-1553 16PP194 Word Bit Error (W). If the bit is set to “1,” this indicates that a Manchester error was detected in the word.
- MIL-STD-1553 16PP194 Word Parity Error (P). If the bit is set to “1,” this indicates that a parity error occurred in the word.
- 16PP194 Data Word. Bits 16-1 contain the 16PP194 data field as in [Figure 11-26](#).

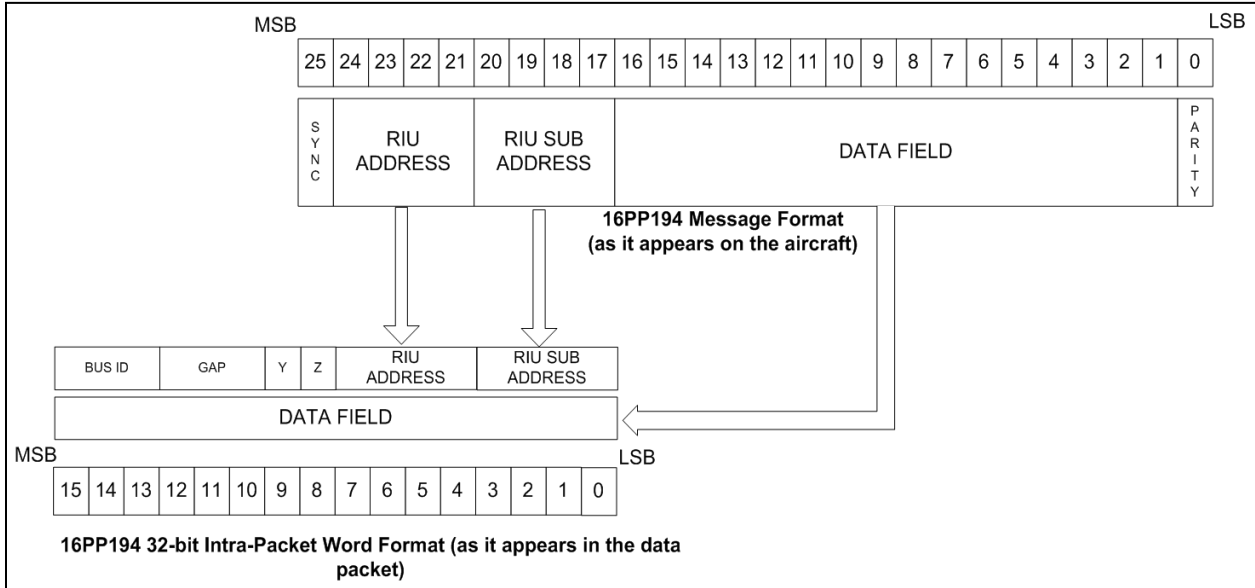

Figure 11-26. 16PP194 Word Format

- 16PP194 Data Word. Bits 24-17 contain the 16PP194 remote interface unit (RIU) address and RIU subaddress as in [Figure 11-26](#).

### 11.2.5 Analog Data Packets

#### 11.2.5.1 Analog Data Packets, Format 0 Reserved.

#### 11.2.5.2 Analog Data Packets, Format 1 The generic packet structure for analog data is illustrated in [Table 11-22](#).

<b>Table 11-22. Generic Analog Data Packet, Format 1</b>	
Packet Header	
Channel-Specific Data Word, Subchannel 1	
Channel-Specific Data Word, Subchannel 2	
:	
:	
:	
Channel-Specific Data Word, Subchannel M	
Sample 1	
Sample 2	



An analog data packet will contain a CSDW for each subchannel of analog data sampled within that packet if the SAME bit is set to 0, or it will contain a single CSDW for the entire analog packet if the SAME bit is set to 1. This will be followed by at least one complete sampling schedule of data.

A sampling schedule is defined as a sampling sequence in which each subchannel, described by a CSDW, is sampled at least once. In many cases, due to simultaneous sampling rules and varied sampling rates, a particular subchannel will be sampled more than once during a sampling schedule. In addition, multiple complete sampling schedules may be included in a single packet. For these reasons, the number of CSDWs will usually be less than the number of samples.

[Table 11-22](#) depicts the generic packet data structure for M data subchannels and a single sampling schedule that has a length N. Note that the width of the structure is not related to any number of bits and is merely intended to represent relative placement of words within the packet.

	<p><b>NOTE</b> The packet header time in an analog data packet shall correspond to the first data sample in the packet. There are no IPHs in analog data packets.</p>
--	---

- a. Analog Packet Channel-Specific Data. The packet body portion of each analog packet begins with the CSDW(s). Each subchannel that is sampled with the packet sampling schedule must have a CSDW within the packet. Only one CSDW is required if subchannels are sampled at the same sampling rate (FACTOR), and have the same bits per sample (LENGTH) and same packing mode (MODE). Bit 28 of the CSDW shall be used to indicate same sampling data rate for subchannels.

The CSDWs for analog data packets are formatted as shown in [Figure 11-27](#).

msb												lsb
31	29	28	27	24	23	16	15	8	7	2	1	0
RESERVED		SAME	FACTOR	TOTCHAN		SUBCHAN		LENGTH		MODE		

Figure 11-27. Analog Packet Channel-Specific Data Word

- Reserved. Bits 31-29 are reserved.
- Same. Bit 28 specifies if this CSDW applies for all the channels included in the packet or if each channel has its own CSDW.
  - 0 = Each analog channel has its own CSDW.
  - 1 = The CSDW is valid for all analog channels stored in this packet.

- Factor. Bits 27-24 are the exponent of the power of 2 sampling rate factor denominator for the corresponding subchannel in the range 0 to 15. (The sampling rate factor numerator is always 1.)

0x0 = Sampling rate factor denominator  $2^0 = 1 \Rightarrow$  factor = 1/1

0x1 = Sampling rate factor denominator  $2^1 = 2 \Rightarrow$  factor = 1/2

0x2 = Sampling rate factor denominator  $2^2 = 4 \Rightarrow$  factor = 1/4

:

0xF = Sampling rate factor denominator  $2^{15} = 32768 \Rightarrow$  factor = 1/32768

- Totchan. Bits 23-16 indicate the total number of analog subchannels in the packet (and the number of CSDWs in the packet).

This field must be the same value in all CSDWs in a single packet. The Totchan value may be less than the largest Subchan value. This can happen when a multi-channel analog input device has some of its subchannels disabled (turned off) for a specific acquisition session. For example, if an analog input device has eight subchannels and not all eight are active, an analog data packet may have three subchannels (Totchan = 3) numbered 4, 7, and 8 (enabled Subchan = 4, 7, 8). The number of subchannels (Totchan) and the subchannel number for each active subchannel (Subchan) in a packet are identified in the accompanying Telemetry Attributes Transfer Standard (TMATS) (Computer-Generated Data, Format 1) packet.

0x00 = 256 subchannels

0x01 = 1 subchannel

0x02 = 2 subchannels

- Subchan. Bits 15-8 indicate a binary value representing the number or subchannel ID of the analog subchannel.

When an analog packet contains data from more than one subchannel and the CSDWs are not the same for all channels (see field Same, bit 28), the CSDWs must be inserted into the packet in ascending subchannel number as identified by this field. The Subchan values in these CSDWs need not be contiguous (see Totchan), but they must be in ascending decimal numerical order with the exception that subchannel 0 (256) is last. If the Same bit is set, the Subchan field shall be set to zero.

0x01 = Subchannel 1

0x02 = Subchannel 2

:

0x00 = Subchannel 256

:

- Length. Bits 7-2 indicate a binary value representing the number of bits in the analog-to-digital converter.

000000 = 64-bit samples

000001 = 1-bit samples

:

001000 = 8-bit samples

:

001100 = 12-bit samples

:

- Mode. Bits 1-0 indicate alignment and packing modes of the analog data. When Totchan is more than 1, MODE must be the same for all subchannels in a single packet.

00 = Data is packed

01 = Data is unpacked, lsb padded

10 = Reserved for future definition

11 = Data is unpacked, msb padded

	For the special case of defining a single channel (Totchan = 1), there are two options: a) one channel with no subchannels; or b) one channel as its own subchannel. In such cases the bits are to be defined as follows.		
		One channel with no subchannel	One channel with one subchannel
	Totchan (bits 23-16)	1	1
	Same (bit 28)	1	0
	Subchan (bits 15-8)	0	1

- b. Analog Samples. A simultaneous sampling scheme shall be employed to preserve timing relationships and allow for accurate reconstruction of the data. The highest sampling rate required shall define the primary simultaneous sampling rate within the packet. The primary simultaneous sampling rate is identified in the TMATS file describing the attributes of the analog data packet. The rate at which the other subchannels are sampled is then defined by the sampling factor (1, 1/2, 1/4, 1/8, 1/16, 1/32768) for each subchannel. As an example, a sampling factor of 1/4 would yield that subchannel being sampled at one-fourth the primary simultaneous sampling rate and a sampling factor of 1 would yield that subchannel being sampled at the primary simultaneous sampling rate.

Directly following the CSDW(s), at least one complete sampling schedule shall be inserted in the packet. The samples, within the sampling sequence, may be inserted either unpacked, msb packed, or lsb packed as described in Subsection [11.2.5.2](#) items [b\(1\)](#) and [b\(2\)](#). In either case, one or more subchannels may be included in a single packet. When multiple subchannels are encapsulated into a single packet, the subchannel with the highest sampling rate requirement defines the primary simultaneous sampling rate. The rate at which the other subchannels are sampled is defined by the sampling factor (contained within the CSDWs). Sampling factors are defined as:

$$\left(\frac{1}{2^K}\right) * X \quad ; K = 0, 1, 2, 3, 4, 5, \dots$$

of the primary simultaneous sampling rate X.

The subchannels are then sampled and ordered such that:

- The highest sample rate 1\*X subchannel(s) appear in every simultaneous sample;



- The  $\left(\frac{1}{2}\right) * X$  subchannel(s) appear in every 2nd simultaneous sample;
- The  $\left(\frac{1}{4}\right) * X$  subchannel(s) appear in every 4th simultaneous sample;

... and so on until all the subchannels are sampled, resulting in a complete sampling schedule of all subchannels described by the CSDWs. In doing so, the total number of simultaneous samples (not the total number of samples) will equal the denominator of the smallest sampling factor and all subchannels will be sampled in the last simultaneous sample.

For example, a packet with six subchannels with sampling factors  $\frac{1}{2}$ ,  $\frac{1}{8}$ , 1,  $\frac{1}{2}$ , 1, and  $\frac{1}{8}$  respectively will yield a sampling sequence within the data packet as:

Simultaneous Sample 1:	Subchannel 3
Simultaneous Sample 1:	Subchannel 5
Simultaneous Sample 2:	Subchannel 1
Simultaneous Sample 2:	Subchannel 3
Simultaneous Sample 2:	Subchannel 4
Simultaneous Sample 2:	Subchannel 5
Simultaneous Sample 3:	Subchannel 3
Simultaneous Sample 3:	Subchannel 5
Simultaneous Sample 4:	Subchannel 1
Simultaneous Sample 4:	Subchannel 3
Simultaneous Sample 4:	Subchannel 4
Simultaneous Sample 4:	Subchannel 5
Simultaneous Sample 5:	Subchannel 3
Simultaneous Sample 5:	Subchannel 5
Simultaneous Sample 6:	Subchannel 1
Simultaneous Sample 6:	Subchannel 3
Simultaneous Sample 6:	Subchannel 4
Simultaneous Sample 6:	Subchannel 5
Simultaneous Sample 7:	Subchannel 3
Simultaneous Sample 7:	Subchannel 5
Simultaneous Sample 8:	Subchannel 1
Simultaneous Sample 8:	Subchannel 2
Simultaneous Sample 8:	Subchannel 3
Simultaneous Sample 8:	Subchannel 4
Simultaneous Sample 8:	Subchannel 5
Simultaneous Sample 8:	Subchannel 6

Notice that the denominator of the smallest sampling factor defines the number of simultaneous samples within the packet (in this example, 8); however, the total number of samples within the sampling schedule does not have to equal the number of simultaneous samples (in this example, 26). Also notice that all subchannels are sampled during the last simultaneous sample. The order of the subchannel samples in each simultaneous sample is ascending by subchannel number.

Any number of complete sampling schedules may be placed within a packet so that the maximum packet length is not exceeded.

- (1) Unpacked Mode. In unpacked mode, packing is disabled and each sample is padded with the number of bits necessary to align each word with the next 16-bit boundary in the packet. Four pad bits are added to 12-bit words, eight pad bits are added to 8-bit words, etc. All pad bits shall equal zero.

 <p><b>NOTE</b></p>	<p>Samples less than 8 bits go into a 16-bit word boundary.</p>
--	---

To illustrate msb padding, given M analog subchannels mapping into N samples for the special case of all samples having bit lengths of 12 bits, the resultant analog packets with msb padding have the form shown in [Table 11-23](#).

<b>Table 11-23. Analog Data Packet-Unpacked Mode, msb Padding</b>	
msb	lsb
15	0
Packet Header	
Channel-Specific Data Word, Subchannel 1 (Bits 15-0)	
Channel-Specific Data Word, Subchannel 1 (Bits 31-16)	
Channel-Specific Data Word, Subchannel 2 (Bits 15-0)	
Channel-Specific Data Word, Subchannel 2 (Bits 31-16)	
:	
:	
:	
Channel-Specific Data Word, Subchannel M (Bits 15-0)	
Channel-Specific Data Word, Subchannel M (Bits 31-16)	
4 Pad Bits	Sample 1, 12 Data Bits
4 Pad Bits	Sample 2, 12 Data Bits
4 Pad Bits	Sample 3, 12 Data Bits
:	
4 Pad Bits	Sample N, 12 Data Bits
Packet Trailer	

To illustrate lsb packing, given M analog subchannels mapping into N samples for the special case of all samples having bit lengths of 12 bits, the resultant analog packets with lsb padding have the form shown in [Table 11-24](#).

<b>Table 11-24. Analog Data Packet-Unpacked Mode, lsb Padding</b>	
msb	lsb
15	0
Packet Header	
Channel-Specific Data Word, Subchannel 1 (Bits 15-0)	

Channel-Specific Data Word, Subchannel 1 (Bits 31-16)	
Channel-Specific Data Word, Subchannel 2 (Bits 15-0)	
Channel-Specific Data Word, Subchannel 2 (Bits 31-16)	
:	
:	
:	
Channel-Specific Data Word, Subchannel M (Bits 15-0)	
Channel-Specific Data Word, Subchannel M (Bits 31-16)	
:	
Sample 1, 12 Data Bits	4 Pad Bits
Sample 2, 12 Data Bits	4 Pad Bits
Sample 3, 12 Data Bits	4 Pad Bits
:	
Sample N, 12 Data Bits	4 Pad Bits
Packet Trailer	

- (2) Packed Mode. In packed mode, packing is enabled and padding is not added to each data word; however, if the number of bits in the packet are not an integer multiple of 16, then Y filler bits will be used to msb fill the last data word, forcing alignment on a 16-bit boundary. The value of Y is 16 minus the integer remainder of L, the total number of data bits in the packet, divided by 16 and is mathematically expressed as:

$$Y = 16 - (\text{MODULUS}\{L, 16\}).$$

To illustrate msb padding, given M analog subchannels mapping into N samples for the special case of all samples having bit lengths of 12 bits, the resultant analog packets with padding bits at the end of the Nth sample have the form shown in [Table 11-25](#).

<b>Table 11-25. Analog Data Packet-Packed Mode Packet</b>	
msb	lsb
15	0
Packet Header	
Channel-Specific Data Word, Subchannel 1 (Bits 15-0)	
Channel-Specific Data Word, Subchannel 1 (Bits 31-16)	
Channel-Specific Data Word, Subchannel 2 (Bits 15-0)	
Channel-Specific Data Word, Subchannel 2 (Bits 31-16)	
:	
:	
:	
Channel-Specific Data Word, Subchannel M (Bits 15-0)	
Channel-Specific Data Word, Subchannel M (Bits 31-16)	
Sample 2 (Bits 3-0)	Sample 1 (Bits 11-0)
Sample 3 (Bits 7-0)	Sample 2 (Bits 11-4)

:	:
:	:
:	:
Y Padding Bits	Sample N (Bits 11-0)
:	:
Packet Trailer	



11.2.5.3 Analog Data Packets, Format 2  
 This analog format will be added in a future release.



11.2.5.4 Analog Data Packets, Format 3 (I/Q Recording of Intermediate Frequencies)  
 The Analog Data Packet, Format 3 is a special case of the generic Analog Data Packet, Format 1 for the recording and reproduction of IF signals. This IF signal, typically a value of 70.0 MHz, is a downconverted representation of an RF signal. This RF signal is generally in the authorized telemetry frequency bands of L, S, and C.

With Format 3, the data is sampled from in-phase and quadrature (I/Q) signals issued from IQ transposition of the IF signal to baseband. This defines two analog subchannels; the first being I and the second being Q. See [Figure 11-28](#). Each packet will contain samples from one IF signal source. The multiplexing of IF sources is not permissible.

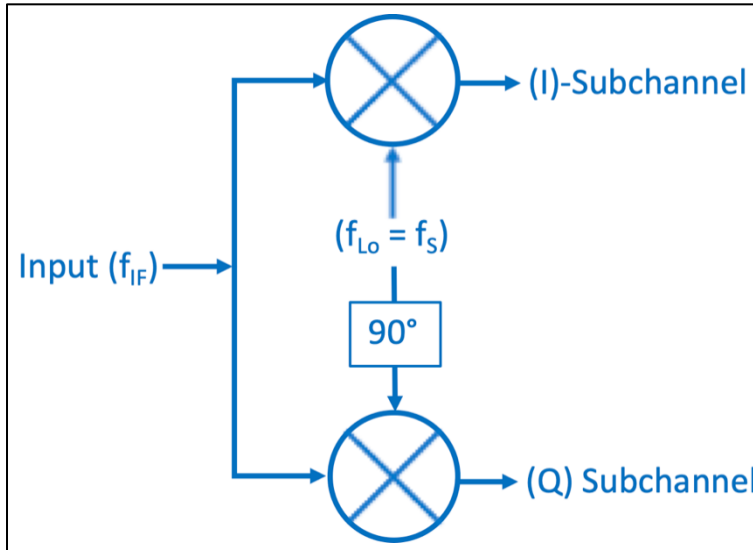
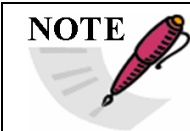



Figure 11-28. Analog Packet Format 3, I/Q Sampling



The current version of Analog Data Packets, Format 3 is applicable for recording and reproducing IF 70MHz signals from and to Telemetry receiver IF input/outputs. Because the typical IF 70MHz output level from telemetry receivers across the market is regulated and normalized around -5dBm, it will be assumed that the max input level of the IF 70MHz signal to be 0dBm. The same applies for the IF 70MHz outputs (reproducing).

 <p><b>NOTE</b></p>	<p>The TMATS, <i>Analog Data Types Attributes</i>, for the IF and CF frequencies are documented in <a href="#">Chapter 9</a> <i>R-x\AIF</i> and <i>R-x\ACF</i>.</p>
--	---

Packet structure for Analog Data Format 3 is illustrated in [Table 11-26](#).

<b>Table 11-26. Analog Data Packet, Format 3</b>
Packet Header
Channel-Specific Data Word
Subchannel I – Sample 1
Subchannel Q – Sample 1
Subchannel I – Sample 2
Subchannel Q – Sample 2
:
Subchannel I – Sample N
Subchannel Q – Sample N
Packet Trailer

An Analog Data Packet of Format 3 will contain a single CSDW for the entire analog packet with the SAME bit set to 1. This will be followed by at least one complete sampling schedule of data.

A sampling schedule is defined as a sampling sequence in which each I/Q subchannel is sampled at least once and the same number of times.

[Table 11-26](#) depicts the generic packet data structure for I/Q data subchannels and a single sampling schedule that has a length N. Note that the width of the structure is not related to any number of bits and is merely intended to represent relative placement of words within the packet.

 <p><b>NOTE</b></p>	<p>The packet header time in an analog data packet shall correspond to the first data sample in the packet. There are no IPHs in analog data packets.</p>
--	---

- a. Analog Packet Channel-Specific Data. The packet body portion of each analog packet begins with the CSDW. Only one CSDW is required as the I/Q subchannels are sampled at the same sampling rate (FACTOR) and have the same bits per sample (LENGTH) and same packing mode (MODE). Bit 28 of the CSDW shall be set to 1.

 <p><b>NOTE</b></p>	<p>In the current version of the standard, Analog Data Packets Format 3, bits 31-8 can be considered hardcoded as <b>0x100200</b>.</p>
--	--

The CSDWs for Analog Data Packets Format 2 are formatted as shown in [Figure 11-29](#).

MSB	LSB
31	8 7 2 1 0
<b>0x100200</b>	LENGTH   MODE

Figure 11-29. Analog Packet Format 3, Channel-Specific Data Word

- **Length.** Bits 7-2 indicate a binary value representing the number of bits in the analog-to-digital converter.

000000 = 64-bit samples

000001 = 1-bit samples

:

001000 = 8-bit samples

:

001100 = 12-bit samples

:

- **Mode.** Bits 1-0 indicate alignment and packing modes of the analog data. When Totchan is more than 1, MODE must be the same for all subchannels in a single packet.

00 = Data is packed

01 = Data is unpacked, LSB padded

10 = Reserved for future definition

11 = Data is unpacked, MSB padded

- b. **Analog Samples.** The sampling rate is identified in the TMATS fields describing the attributes of the analog data channel. The rate at which the I/Q subchannels are sampled is equal to the sampling rate.

Directly following the CSDW(s), at least one complete sampling schedule shall be inserted in the packet. The samples within the sampling sequence may be inserted either packed, unpacked MSB padded, or unpacked LSB padded as described in the Analog Data Packets Format 1, Subsection [11.2.5.2](#) items [b\(1\)](#) and [b\(2\)](#). In either case, the two I/Q subchannels shall be included in a single packet.

Any number of complete sampling schedules may be placed within a packet as long as the maximum packet length is not exceeded.

## 11.2.6 Discrete Data Packets

### 11.2.6.1 Discrete Data Packets, Format 0.

Reserved.

### 11.2.6.2 Discrete Data Packets, Format 1

A packet with discrete data has the basic structure shown in [Table 11-27](#). Note that the width of the structure is not related to any number of bits. This drawing is merely intended to represent relative placement of data in the packet. One to 32 discrete states may be recorded for each event.

<b>Table 11-27. General Discrete Data Packet, Format 1</b>
Packet Header
Channel-Specific Data
Intra-Packet Header for Event 1
Event 1 States
Intra-Packet Header for Event 2
Event 2 States
:
Intra-Packet Header for Event N
Event N States
Packet Trailer

- a. Discrete Packet Channel-Specific Data Word. The packet body portion of each discrete packet begins with the CSDW, which is formatted as shown in [Figure 11-30](#).

msb						lsb	
31		8	7		3	2	0
RESERVED				LENGTH		MODE	

Figure 11-30. Discrete Packet Channel Data Word

- Reserved. Bits 31-8 are reserved.
  - Length. Bits 7-3 indicate a binary value representing the number of bits in the event. The value of zero indicates 32 bits.
  - Mode. Bits 2-0 indicate the mode of accessing the discrete data.
    - Bit 0: indicates the record state.
      - 0 = discrete data is recorded when the state changes
      - 1 = discrete data is recorded on a time interval basis
    - Bit 1: indicates the alignment of the data.
      - 0 = lsb
      - 1 = msb
    - Bit 2: reserved.
- b. Discrete Data. After the channel-specific data, discrete data ([Figure 11-31](#)) is inserted in the packet. Discrete data are described as events. Each event includes the event state for each discrete input and the corresponding intra-packet time. The event state is a 32-bit word that provides the logical state of each discrete input.

msb						lsb
31	30				1	0
D31	D30	...			D1	D0

Figure 11-31. Discrete Data Format

- Discrete Event Bits. Bits 31-0 indicate the states of the discrete event bits.

Bit 31: indicates discrete 31 (D31) state.

- 0 = discrete 31 is at state 0
- 1 = discrete 31 is at state 1

Bit 30: indicates discrete 30 (D30) state.

- 0 = discrete 30 is at state 0
- 1 = discrete 30 is at state 1

Bit 1: indicates discrete 1 (D1) state.

- 0 = discrete 1 is at state 0
- 1 = discrete 1 is at state 1

Bit 0: indicates discrete 0 (DO) state.

- 0 = discrete 0 is at state 0
- 1 = discrete 0 is at state 1

- c. Discrete Event Intra-Packet Header. All discrete events shall include an IPH consisting of an IPTS only, which is inserted immediately before the discrete event. The length of the IPH is fixed at 8 bytes (64 bits) positioned contiguously, arranged in the sequence shown in [Figure 11-32](#).

msb	lsb
31	0
Time (LSLW)	
Time (MSLW)	

Figure 11-32. Discrete Event Intra-Packet Header

- Intra-Packet Time Stamp. These 8 bytes indicate the time tag of the discrete event. First long word bits 31-0 and second long word bits 31-0 indicate the following values:
  - (1) The 48-bit RTC that corresponds to the first data bit of the discrete event with bits 31 to 16 in the second long word zero filled; or
  - (2) The absolute time, if enabled by bit 6 in the packet flags (Subsection [11.2.1.1](#) item [g](#)). The time format is indicated by bits 2 and 3 in the packet flags (Subsection [11.2.1.1](#) item [g](#)). The time tag shall be correlated to the first data bit of the discrete event. The discrete data packet format is presented in [Table 11-28](#).

<b>Table 11-28. Discrete Data Packet Format</b>	
msb	lsb
15	0
Packet Header	
Channel-Specific Data (Bits 15-0)	
Channel-Specific Data (Bits 31-16)	
Intra-Packet Time Stamp for Event 1 (Bits 15-0)	
Intra-Packet Time Stamp for Event 1 (Bits 31-16)	
Intra-Packet Time Stamp for Event 1 (Bits 47-32)	



Intra-Packet Time Stamp for Event 1 (Bits 63-48)
States for Event 1 (Bits 15-0)
States for Event 1 (Bits 31-16)
:
Intra-Packet Time Stamp for Event N (Bits 15-0)
Intra-Packet Time Stamp for Event N (Bits 31-16)
Intra-Packet Time Stamp for Event N (Bits 47-32)
Intra-Packet Time Stamp for Event N (Bits 63-48)
States for Event N (Bits 15-0)
States for Event N (Bits 31-16)
Packet Trailer

### 11.2.7 Computer-Generated Data Packets

Packets with computer-generated data have the basic structure shown in [Table 11-29](#). Formats 0, 1, 2, 3, and 4 are used to add information packets to recorded data. This information contains annotation data, setup records, events, or index information for the data that has been recorded. The width of the structure is not related to any number of bits. This drawing is merely intended to represent relative placement of data in the packet.

<b>NOTE</b> 	Computer-generated data is defined as non-external data or data generated within the recorder. After the CSDW, the computer-generated data is inserted in the packet. The organization and content of the computer-generated data is determined by the specific format type.
--	--

<b>Table 11-29. General Computer-Generated Data Packet Format</b>
Packet Header
Channel-Specific Data
Computer Generated Data
Packet Trailer

#### 11.2.7.1 Computer-Generated Data Packets Format 0, User-Defined

Format 0 enables the insertion of user-defined computer-generated data. Data shall not be placed in packets of this type if the data type is already defined within this standard nor shall data be inserted in this packet if it is directly generated from an external input to the recorder.

- Format 0 Channel-Specific Data Word. The packet body portion of each Format 0 packet begins with the CSDW, which is formatted as shown in [Figure 11-33](#).
- Reserved. Bits 31-0 are reserved.

msb	lsb
31	0
RESERVED	

Figure 11-33. Computer-Generated Format 0 Channel-Specific Data Word

<b>NOTE</b> 	For this format, bits 31-0 are declared reserved; however, they are considered as “User” or “Application” defined.
--	--

11.2.7.2 Computer-Generated Data Packets Format 1, Setup Records

Format 1 defines a setup record that describes the hardware, software, and data channel configuration used to produce the other data packets in the file. The organization and content of a Format 1 setup record is indicated in the CSDW FRMT field.

A single setup record may span multiple consecutive packets. When spanning multiple packets, the sequence counter shall increment in the order of segmentation of the setup record,  $n+1$ .

- a. Format 1 Channel-Specific Data Word. The packet body portion of each Format 1 packet begins with the CSDW, which is formatted as shown in [Figure 11-34](#).

Msb	lsb
31	0
10 9 8 7	
RESERVED	FRMT SRCC RCCVER

Figure 11-34. Computer-Generated Format 1 Channel-Specific Data Word

- Reserved. Bits 31-10 are reserved.
- FRMT. Bit 9 is the setup record format.
  - 0 = Setup record IAW [Chapter 9](#) ASCII Format
  - 1 = Setup record IAW [Chapter 9](#) XML Format

<b>NOTE</b> 	It is not permissible to have both ASCII and XML <a href="#">Chapter 9</a> TMATS attributes in the same session (e.g., recording).
--	--

- Setup Record Configuration Change (SRCC). Bit 8 indicates if the recorder configuration contained in the previous setup record packet(s) of the current recording session (defined as .RECORD to .STOP) has changed.
  - 0 = Setup record configuration has not changed
  - 1 = Setup record configuration has changed

<b>NOTE</b> 	When a setup record configuration change has taken place, bit 8 (SRCC) shall be set to 1 and the new setup record packet will be committed to the stream prior to any new or changed data packets being committed to the stream. The next setup record packet(s) committed to the stream, if not changed from this new setup record, shall clear the SRCC bit to 0.
--	---

 <p><b>NOTE</b></p>	<p>Prior to the new setup record being committed to the stream, a setup record configuration change event packet shall be inserted into the stream.</p>
--	---

 <p><b>NOTE</b></p>	<p>Each new setup record packet must adhere to all applicable setup record requirements including, but not limited to, the minimum required TMATS attributes.</p>
--	---

- RCC 106 Version (RCCVER). Bits 7-0 specify which RCC release version applies and to which the following recorded data complies with. The value shall be represented by the following bit patterns.

0x00 through 0x06 = Reserved  
 0x07 = RCC 106-07  
 0x08 = RCC 106-09  
 0x09 = RCC 106-11  
 0x0A = RCC 106-13  
 0x0B = RCC 106-15  
 0x0C = RCC 106-17  
 0x0D = RCC 106-19  
 0x0E = RCC 106-22  
 0x0F through 0xFF = Reserved

Individual Chapter 11 data types and their format/content compliance and applicability with the RCC release version are defined in Subsection [11.2.1.1](#) item [e](#).

Note that this field was known as “CH10VER” in RCC versions 106-04 through 106-15, where it was described in [Chapter 10](#) Subsection 10.6.7.2.

### 11.2.7.3 Computer-Generated Data Packets Format 2, Recording Event

Format 2 defines a “Recording Event” packet that contains the occurrence and information of one or more individual events that have been defined within the Format 1 setup record IAW “Recording Events” attribute. If the recording events information is larger than the maximum packet size of 512 KB, the recording events information may be contained in multiple packets using the major packet header sequence number.

Events associated with the .EVENT command defined in [Chapter 6](#) Subsection 6.2.4.13 can only be directly accessed from the acquisition system itself (e.g., recorder system) and are not contained within the output or recorded data. This does not preclude defining an event driven by the .EVENT command to also be defined within the recording event setup record information and placed in the appropriate event entry within an event packet. The .EVENT command and the “Recording Event” packets will not be directly linked in this standard and any linking between the two will be an implementation of this standard within a recorder.

 <p><b>NOTE</b></p>	<p>It is not the intent for the event packets within the data to be directly coupled with recorder events per the .EVENT command in <a href="#">Chapter 6</a> Subsection 6.2.4.13.</p>
--	--

- a. Event Packet Location. Recording event packets may be placed at any location within the recording after the first time data packet and before the last root index packet. This may be at the time each event occurs, after multiple events have occurred, or at an interval of time or packets. The complete event log of a recording (defined in Subsection [11.2.7.3](#) item c) is constituted by the contents of all event packets in a recording concatenated in order of which the event(s) occurred in time.

 <p><b>NOTE</b></p>	<p>Index packets will be enabled if recording event packets are enabled. Note that Index packets are only meaningful if a Chapter 10 file is being used to record packets.</p>
--	--

- b. Channel-Specific Data Word. The packet body portion of each Format 2 packet begins with the CSDW, which is formatted as shown in [Figure 11-35](#).

msb						lsb
31	30		12	11		0
IPDH	RESERVED				REEC	

Figure 11-35. Computer-Generated Format 2 Channel-Specific Data Word

- Recording Event Intra-Packet Data Header. Bit 31 indicates the presence of the IPDH.
    - 0 = Recording event IPDH not present
    - 1 = Recording event IPDH present
  - Reserved. Bits 30-12 are reserved.
  - Recording Event Entry Count (REEC). Bits 11-0 are an unsigned binary that identifies the count of recording event entries included in the packet.
- c. Event Period of Capture. The event period of capture ([Figure 11-36](#)) is defined to encompass the events occurring from the time a .RECORD command ([Chapter 6](#), Subsection 6.2.2.31) is issued (if it is the first recording) until the time a .STOP command ([Chapter 6](#), Subsection 6.2.3.9) is issued. If there is a previous recording, the period of capture is described as encompassing those events that occur from the previous recording's .STOP command until the .STOP command of the current recording. This ensures that any events that occurred between recordings will be captured and will include special indicators that the event occurred between .STOP and .RECORD commands.

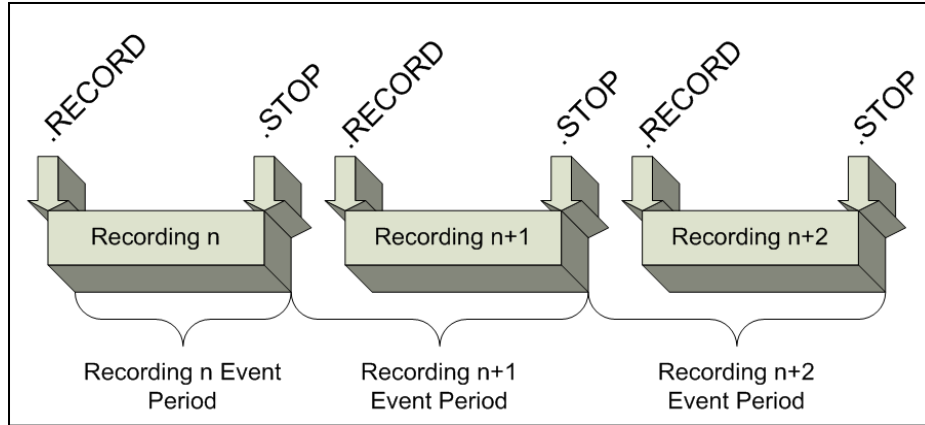

Figure 11-36. Events Recording Period

Priority conditions and event limit counts are defined in the setup record attributes for each defined event. The ability to put finite limits on events during periods of capture precludes overflowing buffers or media capacities. These priority conditions and event limit counts are as follows.

- Priority 1 The defined event will always be captured during and in between recordings.
- Priority 2 The defined event will always be captured during recordings and up to a limit count between recordings.
- Priority 3 The defined event will always be captured during recordings and not captured between recordings.
- Priority 4 The defined event will be captured up to a limit count during recordings and between recordings.
- Priority 5 The defined event will be captured up to a limit count for each defined event during recordings and not captured between recordings.

d. Event Condition of Capture. Event trigger mode conditions during the event period of capture are defined in the setup record attributes for each defined event. These MEASUREMENT DISCRETE, MEASUREMENT LIMIT, or MEASUREMENT CHANGE trigger mode conditions are as follows.

- Mode 1: Capture MEASUREMENT DISCRETE event at each On (1) and Off (0) mode transition sampling.
- Mode 2: Capture MEASUREMENT DISCRETE event at each On (1) mode transition sampling.
- Mode 3: Capture MEASUREMENT DISCRETE event at each Off (0) mode transition sampling.
- Mode 4: Capture MEASUREMENT LIMIT event at each high and low value transition sampling.
- Mode 5: Capture MEASUREMENT LIMIT event at each high value transition sampling.

Mode 6: Capture MEASUREMENT LIMIT event at each low value transition sampling.

Mode 7: Capture MEASUREMENT CHANGE event on each change of value from the previous value.

 <p><b>NOTE</b></p>	<p>If Event Type is MEASUREMENT DISCRETE, MEASUREMENT LIMIT, or MEASUREMENT CHANGE, the trigger measurement must be fully described using the setup record attributes for PCM, bus, analog, or discrete channels. The trigger measurement source and measurement name shall be identified in the event definition.</p>
--	--

- e. Event Initial Capture. Event initial capture conditions are defined in the setup record attributes for each defined event. This determines if an event will be captured initially prior to the transition mode set for the event if the transition has already occurred prior to the event period of capture.

For a Mode 7 capture of a MEASUREMENT CHANGE event, there shall be an option for an initial value in the setup record that does not generate an event but each successive value change from this initial value shall generate an event. Event limit counts for mode 7 shall be valid on the number of events generated based on successive value changes from each previous value.

- f. Event Trigger Measurement Description. If Event Type is MEASUREMENT DISCRETE, MEASUREMENT LIMIT, or MEASUREMENT CHANGE, the event trigger measurement must be fully described using the setup record attributes for PCM, bus, analog, or discrete channels. This shall include at a minimum the following attributes for the trigger measurement.

- (1) Measurement source (via data link name)
- (2) Measurement name
- (3) Applicable measurement value definition or bit mask
- (4) High measurement value (if MEASUREMENT LIMIT at or above the high limit is used to trigger the event)
- (5) Low measurement value (if MEASUREMENT LIMIT at or below the low limit is used to trigger the event)
- (6) (Optional) Initial measurement value (if MEASUREMENT CHANGE is used to trigger the event)
- (7) Applicable measurement name engineering unit conversion

- g. Recording Event Intra-Packet Time Stamp. These 8 bytes indicate the time tag of the recording event entry as follows.

- (1) The 48-bit RTC that corresponds to the event entry with bits 31 to 16 in the second long word zero-filled. For event types that are MEASUREMENT DISCRETE or MEASUREMENT LIMIT, the time tag will correspond to the data packet timing mechanism containing the trigger measurement. This will either be the packet

header RTC value or, if enabled, the IPTS - whichever most accurately provides the time the event occurred; or

- (2) The absolute time, if enabled by bit 6 in the packet flags (Subsection [11.2.1.1](#) item [g](#)). The time format is indicated by bits 2 and 3 in the packet flags (Subsection [11.2.1.1](#) item [g](#)). The time tag shall be correlated to the event entry. For event types that are MEASUREMENT DISCRETE or MEASUREMENT LIMIT, the time tag will correspond to the data packet timing mechanism containing the trigger measurement. This will either be the packet secondary header or, if enabled and using an absolute time value, the IPTS - whichever most accurately provides the time the event occurred.
- h. (Optional) Recording Event Intra-Packet Data Header. These 8 bytes contain the absolute time of the event occurrence. The time source and format shall be derived from the Time Data Packet, Format 1. Unused high-order bits will be zero-filled as needed, depending on the time type of the time data packet. The format of the recording event IPH is presented in [Figure 11-37](#).

msb	lsb
31	0
Intra-Packet Time Stamp (LSLW)	
Intra-Packet Time Stamp (MSLW)	
(Optional) Intra-Packet Data Header (LSLW)	
(Optional) Intra-Packet Data Header (MSLW)	

Figure 11-37. Recording Event Intra-Packet Header

- i. Event Packet Entry Format. [Table 11-30](#) and [Figure 11-38](#) present the general recording event packet format and recording event entry layout.

<b>Table 11-30. General Recording Event Packet Format</b>
Packet Header
(Optional) Packet Secondary Header
Channel-Specific Data
Intra-Packet Time Stamp for Event 1
(Optional) Intra-Packet Data Header for Event 1
Recording Event 1
Intra-Packet Time Stamp for Event 2
(Optional) Intra-Packet Data Header for Event 2
Recording Event 2
:
Intra-Packet Time Stamp for Event N
(Optional) Intra-Packet Data Header for Event N
Recording Event N
Packet Trailer

msb								lsb	
31	29	28	27		12	11		0	
RESERVED			EO	EVENT COUNT			NUMBER		

Figure 11-38. Recording Event Entry Layout

- Reserved. Bits 31-29 are reserved for future growth and shall be zero-filled.
- Event Occurrence (EO). Bit 28 indicates Event Occurrence State.
  - 0 = Indicates the event occurred after the .STOP command and before the .RECORD command.
  - 1 = Indicates the event occurred after the .RECORD command and before the .STOP command.
- Event Count. Bits 27-12 represent an unsigned binary that identifies the count of up to 65,535 occurrences of an individually defined event (as defined by Event Number in the following paragraph). Event occurrence counts shall begin at 0x0 for the first occurrence of an individual event type (identified by the event number). The event count can roll over to 0x0 and begin to count up again. The event count applicability is for each event period of capture as defined in Subsection 11.2.7.3 item c. The event count shall start from 0x0 at the beginning of each event period of capture incrementing at  $n+0x1$  to 0xFFFF for each event occurrence. If the event count reaches 0xFFFF within the event period of capture it shall roll over to 0x0.
- Event Number. Bits 11-0 represent an unsigned binary that identifies 4096 individual events types defined in the corresponding setup record recording event number. The event number shall begin at 0x0 for the first event type defined in the setup record and increment  $n+1$  for the next event type defined in the setup record.

11.2.7.4 Computer-Generated Data Packets Format 3, Recording Index

 <p><b>NOTE</b></p>	<p>The Recording Index mechanism is only meaningful in the context of a Chapter 10 system, and is undefined where Chapter 11 packets are being streamed.</p>
--	--

This defines an index packet for an individual recording file used for direct access into the recording file. Recording index packets will be enabled when recording event packets are enabled. There are two types of index packets.

- Root Index Packets. These packets contain zero-based byte offset entries that are the beginning of node index packets. The last entry will be an offset to the beginning of the previous root index packet in its chain if there is more than one root index packet, or to the beginning of the root index packet itself, if this root index packet is either the first root index packet of the recording or the only root index packet.

 <p><b>NOTE</b></p>	<p>Root index packets shall not contain filler in the packet trailer and shall contain a 32-bit data checksum in the packet trailer.</p>
--	--



<b>NOTE</b> 	Each recording file with indexes enabled shall have at a minimum one root index type packet.
---	--

- Node Index Packets. These packets contain node item structures containing information about the location of data packets throughout the recording.

<b>NOTE</b> 	At a minimum, an index entry shall exist for each time data packet in the recording and, at a minimum, an index entry shall exist for each recording event packet in the recording.
---	---

<b>NOTE</b> 	If the recording index type uses a count rather than time, the time data packets and computer-generated data packets are not included in the count interval. -If the recording index type uses a time rather than count, the time data packets are not included in the time interval. If the time count value coincides with the time packet rate, then one index entry shall be created.
---	--

<b>NOTE</b> 	If the recording indexes are enabled the Computer-Generated Data Packet, Format 1 setup record count or time interval value cannot be zero.
---	---

- a. Recording Index Packet Location. If indexes are enabled, a root index packet ([Figure 11-39](#)) will be the last packet in any recording file. More than one root index type packet may be created and may be located within the recording. Root index packets are not required to be contiguous. Node index types may be placed at any location within the recording after the first time data packet and before the last root index packet. This may be at an interval of time or packets. If indexes are based on a time interval, the time interval shall be referenced to and based on 10 MHz RTC counts. When a time-based index time interval expiration takes place and all packet(s) are open (not generated), the index offset and time stamp will be based on the first of the opened packets generated. Packet generation and packet generation time shall apply per the definitions in Subsection [11.2.1](#).

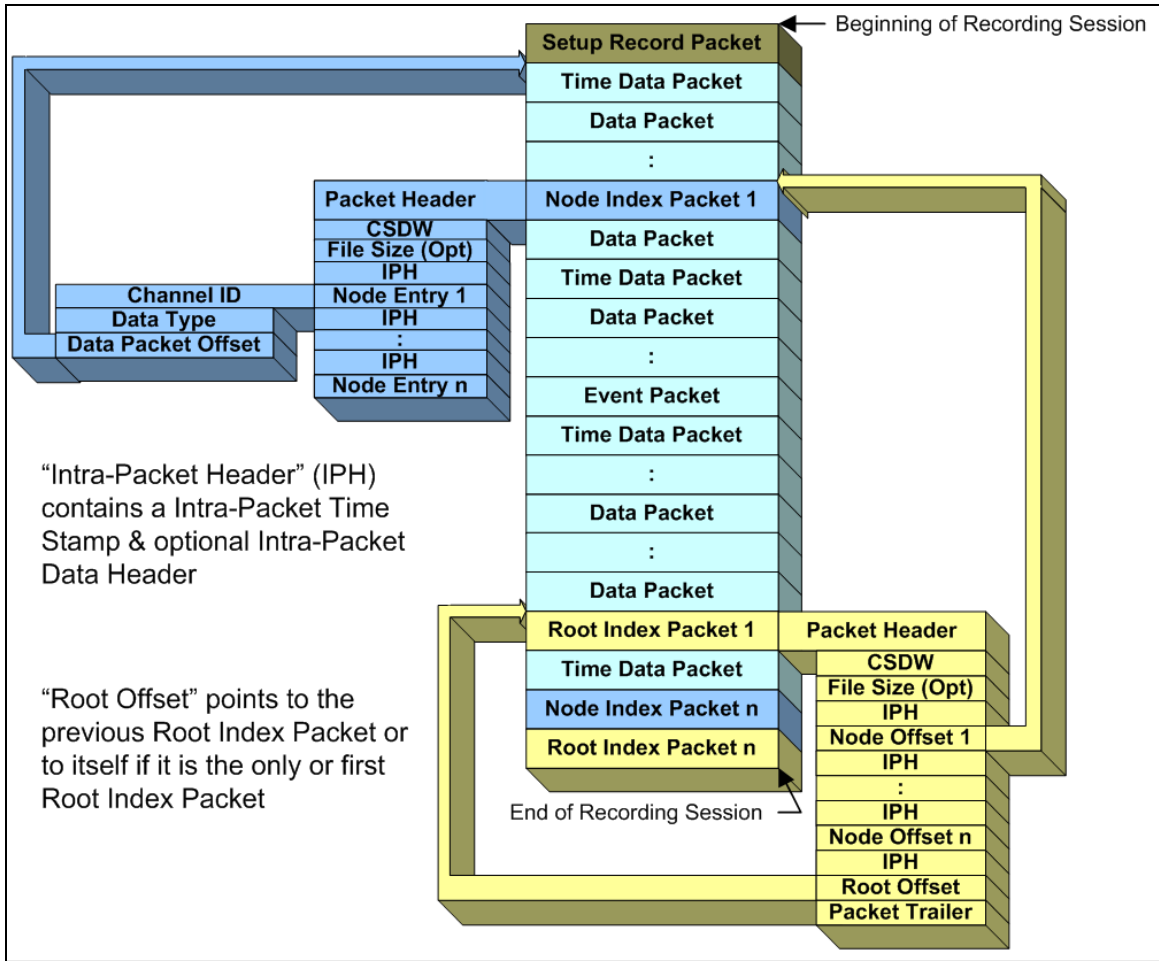

Figure 11-39. Format Showing Root Index Packet

- b. Channel-Specific Data Word. The packet body portion of each Format 3 packet begins with the CSDW, which is formatted as shown in [Figure 11-40](#).

msb								lsb			
31	30	29	28	16				15	0		
IT	FSP	IPDH	RESERVED				INDEX ENTRY COUNT				

Figure 11-40. Computer-Generated Format 3 Channel-Specific Data Word

- Index Type (IT). Bit 31 indicates the type of index packet.
  - 0 = Root index
  - 1 = Node index
- File Size Present (FSP). Bit 30 indicates if the file size at the time the index packet was created is present.
  - 0 = File size not present
  - 1 = File size present
- Index Intra-Packet Data Header. Bit 29 indicates the presence of the IPDH.
  - 0 = Index IPDH not present

1 = Index IPDH present

- Reserved. Bits 28-16 are reserved.
- Index Entry Count. Bits 15-0 indicate the unsigned binary value of the number of index entries included in the packet. An integral number of complete index entries will be in each packet.

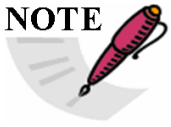
 <p><b>NOTE</b></p>	<p>The IPDH presence once set by bit 29 shall be the same state for the entire recording.</p>
--	---

- c. Recording Index Intra-Packet Time Stamp. These 8 bytes indicate the time tag of the recording index entry as follows.
- The 48-bit RTC that corresponds to the index entry, with bits 31 to 16 in the second long word zero-filled. For node index packets this corresponds to the first bit in the packet body of the packet associated with the node index item; or
  - The absolute time, if enabled by bit 6 in the packet flags (Subsection [11.2.1.1](#) item g). The time format is indicated by bits 2 and 3 in the packet flags (Subsection [11.2.1.1](#) item g). The time tag shall be correlated to the index entry. For node index packets this corresponds to the first bit in the packet body of the packet associated with the node index item.
- d. (Optional) Recording Index Intra-Packet Data Header. These 8 bytes contain the absolute time of the index entry. The time source and format shall be derived from the Time Data Packet, Format 1. Unused high-order bits will be zero-filled as needed, depending on the time type of the time data packet. [Figure 11-41](#) presents the format of the recording index IPH.

msb	lsb
31	0
Intra-Packet Time Stamp (LSLW)	
Intra-Packet Time Stamp (MSLW)	
(Optional) Intra-Packet Data Header (LSLW)	
(Optional) Intra-Packet Data Header (MSLW)	

Figure 11-41. Recording Index Intra-Packet Header

- e. Root Index Packet Entry Format. A root index packet contains a node index offset entry or entries using the format shown in [Table 11-31](#) and [Table 11-32](#).

<b>Table 11-31. General Recording Root Index Packet</b>
Packet Header
(Optional) Packet Secondary Header
Channel-Specific Data
(Optional) Root Index File Size
Intra-Packet Time Stamp for Node Index 1
(Optional) Intra-Packet Data Header for Node Index 1

Node Index Offset 1
:
Intra-Packet Time Stamp for Node Index N
(Optional) Intra-Packet Data Header for Node Index N
Node Index Offset N
Intra-Packet Time Stamp for Root Index
(Optional) Intra-Packet Data Header for Root Index
Root Index Offset
Packet Trailer

<b>Table 11-32. Recording Root Index Entry Layout</b>	
msb	lsb
31	0
(Optional) File Size (LSLW)	
(Optional) File Size (MSLW)	
Intra-Packet Time Stamp for Node Index 1 (LSLW)	
Intra-Packet Time Stamp for Node Index 1 (MSLW)	
(Optional) Intra-Packet Data Header for Node Index 1 (LSLW)	
(Optional) Intra-Packet Data Header for Node Index 1 (MSLW)	
Node Index Offset 1 (LSLW)	
Node Index Offset 1 (MSLW)	
:	
Intra-Packet Time Stamp for Node Index N (LSLW)	
Intra-Packet Time Stamp for Node Index N (MSLW)	
(Optional) Intra-Packet Data Header for Node Index N (LSLW)	
(Optional) Intra-Packet Data Header for Node Index N (MSLW)	
Node Index Offset N (LSLW)	
Node Index Offset N (MSLW)	
Intra-Packet Time Stamp for Root Index (LSLW)	
Intra-Packet Time Stamp for Root Index (MSLW)	
(Optional) Intra-Packet Data Header for Root Index (LSLW)	
(Optional) Intra-Packet Data Header for Root Index (MSLW)	
Root Index Offset (LSLW)	
Root Index Offset (MSLW)	

- (Optional) Root Index File Size. These 8 bytes are an unsigned binary that identifies the current size in bytes of the file at the time the root index packet was created and placed into the recording. This value should be the same as the root index offset. The file size is required when a recording is split across multiple media, individual or multiple channels are split from the original recording file, or time slices are extracted from the original recording. In all cases the original recording file size will allow recalculation and/or replacement of the index offsets when required.

- Node Index Offset. These 8 bytes are an unsigned binary that identifies the zero-based byte offset from the beginning of the recording file to the point in the file at which the node index packet sync pattern (0xEB25) begins.
  - Root Index Offset. These 8 bytes are an unsigned binary that identifies the zero-based byte offset from the beginning of the recording file to the point in the file at which the previous root index packet in its chain begins, if there is more than one root index packet or to itself, if it is the first or only root index packet.
- f. Node Index Packet Entry Format. A node index packet contains an index entry or entries using the format shown in [Table 11-33](#) and [Figure 11-42](#).

<b>Table 11-33. General Recording Node Index Packet</b>	
Packet Header	
(Optional) Packet Secondary Header	
Channel-Specific Data	
(Optional) Node Index File Size	
Intra-Packet Time Stamp for Node Index 1	
(Optional) Intra-Packet Data Header for Node Index 1	
Recording Node Index 1	
Intra-Packet Time Stamp for Node Index 2	
(Optional) Intra-Packet Data Header for Node Index 2	
Recording Node Index 2	
:	
Intra-Packet Time Stamp for Node Index N	
(Optional) Intra-Packet Data Header for Node Index N	
Recording Node Index N	
Packet Trailer	

msb					lsb
31	24	23	16	15	0
Reserved		Data Type		Channel ID	
Data Packet Offset (LSLW)					
Data Packet Offset (MSLW)					

Figure 11-42. Recording Node Index Entry Layout

- (Optional) Node Index File Size. These 8 bytes are an unsigned binary that identifies the current size in bytes of the file at the time the node index packet was created and placed into the recording. This value should be the same as the node index offset. The file size is required when a recording is split across multiple media, individual or multiple channels are split from the original recording file, or time slices are extracted from the original recording. In all cases the original recording file size will allow recalculation and/or replacement of the index offsets when required.
- Channel ID. These 2 bytes are an unsigned binary that identifies a value representing the packet channel ID for the data packet associated with this node index item.

- **Data Type.** This byte is an unsigned binary that identifies a value representing the type and format of the data packet associated with this node index item.
- **Data Packet Offset.** These 8 bytes are an unsigned binary that identifies the zero-based byte offset from the beginning of the recording file to the point in the file at which the data packet sync pattern (0xEB25) begins for this node index packet item.

11.2.7.5 Computer-Generated Data Packets Format 4, Streaming Configuration Records

Format 4 is used to report the active streaming or recording configuration of the system. The organization and content of a Format 4 Streaming Configuration record is indicated in the CSDW FRMT field.

A single Streaming Configuration record may span multiple packets. When spanning occurs, no other Format 4 Computer-Generated Data Packet shall be interspersed, although other packet types are permitted between segments of a Format 4 packet. When spanning multiple packets, the segments shall be output in order, and the last segment shall be flagged in the CSDW.

- a. **Format 4 Channel-Specific Data Word.** The packet body portion of each Format 4 packet begins with the CSDW, which is formatted as shown in [Figure 11-43](#).

msb	lsb
31	0
16 15 14	8 7
RESERVED	LAST FRMT RCCVER

Figure 11-43. Computer-Generated Format 4 Channel-Specific Data Word

- **Reserved.** Bits 31-16 are reserved.
- **FRMT.** Bits 14-8 contain the streaming configuration record format according to the following bit patterns:
  - 000 0000 = Complete record IAW [Chapter 9](#) ASCII Format
  - 000 0001 = Complete record IAW [Chapter 9](#) XML Format
  - 000 0010 = Segmented part of an ASCII Format record
  - 000 0011 = Segmented part of an XML Format record
  - 000 0100 = SHA2-256 Checksum
  - 000 0101 = Currently Selected Channels
- **LAST.** Bit 15 that the current packet is the last packet of a series of segmented packets. Ignored if the FRMT bits do not denote a segmented record.
  - 0 = The current packet is not the last packet.
  - 1 = The current packet is the last packet in a segmented series.
- **RCC 106 Version (RCCVER).** Bits 7-0 specify which RCC release version applies and to which the following recorded data complies with. The value shall be represented by the following bit patterns.
  - 0x00 through 0x0B = Reserved
  - 0x0C = RCC-106-17
  - 0x0D through 0xFF = Reserved

Individual Chapter 11 data types and their format/content compliance and applicability with the RCC release version are defined in Subsection [11.2.1.1](#) item [e](#).

- b. **Full or Segmented ASCII or XML Format Records.** Immediately following the CSDW in the case of the complete or segmented versions of either the ASCII or XML variants of the full TMATS configuration record shall be the text of the TMATS record, or (if segmented) the text that immediately sequentially follows the last character of the previous segmented part of the TMATS record.
- c. **SHA2-256 Checksum.** Immediately following the CSDW shall be 32 bytes containing the binary representation of the 256-bit SHA2 checksum, calculated IAW [Chapter 6](#) Subsection 6.2.3.11.f. This structure is shown in [Table 11-34](#). Note that Subsection 6.2.3.11.f and the [Chapter 9](#) “G\SHA” attribute both reference hexadecimal representations of the binary value used in this record.

<b>Table 11-34. SHA2-256 Checksum Packet Layout</b>	
msb	lsb
31	0
<b>Packet Header</b>	
Channel-Specific Data (Bits 31-0)	
Checksum bits 255-224	
Checksum bits 223-192	
Checksum bits 191-160	
Checksum bits 159-128	
Checksum bits 127-96	
Checksum bits 95-64	
Checksum bits 63-32	
Checksum bits 31-0	
<b>Packet Trailer</b>	

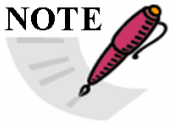
 <p><b>NOTE</b></p>	<p>To avoid confusion, the “big endian” format referenced by FIPS 180-2 shall be used. Thus each 32 bit portion of the checksum shown above shall be treated as “big endian”.</p>
--	---

- d. **Currently Selected Channels.** Immediately following the CSDW shall be a 16-bit count of the number of 16-bit words that follow, with each following word providing the channel ID of a channel currently selected (or enabled) for output. This structure is shown in [Table 11-35](#). The order of the channels in the body of the record is implementation-dependent.

<b>Table 11-35. Currently Selected Channel Layout</b>	
msb	lsb
15	0
<b>Packet Header</b>	
Channel-Specific Data (Bits 15-0)	

Channel-Specific Data (Bits 31-16)
Number of Valid Channels to follow
Channel ID #1
Channel ID #2
:
Channel ID #n
[ optional filler bytes ]
Packet Trailer

11.2.8 ARINC-429 Data Packets

11.2.8.1 ARINC-429 Data Packets, Format 0

Data shall be packetized in word mode: each 32-bit word of an ARINC-429 bus shall be preceded by an IPH containing an IPDH only with an identifier (ID word) that provides type and status information. The IPH does not contain an IPTS. The packet time in the packet header is the time of the first ARINC data word in the packet, and the time of successive ARINC data words is determined from the first word time using the gap times in the ID words that precede each of the data words. Multiple words of multiple ARINC-429 buses can be inserted into a single packet. The resultant packets shall have the following format as shown in [Table 11-36](#).

<b>Table 11-36. ARINC-429 Data Packet Format</b>	
msb	lsb
15	0
Packet Header	
Channel-Specific Data (Bits 15-0)	
Channel-Specific Data (Bits 31-16)	
Word 1 Intra-Packet Data Header	
Word 1 Intra-Packet Data Header	
ARINC-429 Data Word 1 (Bits 15-0)	
ARINC-429 Data Word 1 (Bits 31-16)	
Word 2 Intra-Packet Data Header	
Word 2 Intra-Packet Data Header	
ARINC-429 Data Word 2 (Bits 15-0)	
ARINC-429 Data Word 2 (Bits 31-16)	
:	
Word N Intra-Packet Data Header	
Word N Intra-Packet Data Header	
ARINC-429 Data Word N (Bits 15-0)	
ARINC-429 Data Word N (Bits 31-16)	
Packet Trailer	

 <p><b>NOTE</b></p>	<p>Time tagging of ARINC-429 shall correspond to the first data bit of the packet.</p>
--	--



- a. ARINC-429 Packet Channel-Specific Data Word. The packet body portion of each ARINC-429 data packet shall begin with a CSDW formatted as shown in [Figure 11-44](#).

msb										lsb
31				16	15					0
RESERVED					MSGCOUNT					

Figure 11-44. ARINC-429 Packet Channel-Specific Data Word

- Reserved. Bits 31-16 are reserved
  - Message Count (MSGCOUNT). Bits 15-0 indicate the binary value of the number of ARINC-429 words included in the packet.
- b. Intra-Packet Data Header. Bits 31-0 contain the ARINC-429 ID word. Each ARINC-429 bus data word is preceded by an ID word and the bit definitions are as shown in [Figure 11-45](#).

msb										lsb
31		24	23	22	21	20	19			0
BUS			FE	PE	BS	R	GAP TIME			

Figure 11-45. Intra-Packet Data Header Format

- Bus. Bits 31-24 indicate a binary value identifying the ARINC-429 bus number associated with the following data word. The first bus is indicated by 0. A maximum of 256 buses can be placed in one packet.
  - Format Error (FE). Bit 23 indicates an ARINC-429 format error.
    - 0 = No format error has occurred
    - 1 = Format error has occurred
  - Parity Error (PE). Bit 22 indicates an ARINC-429 parity error.
    - 0 = No parity error has occurred
    - 1 = Parity error has occurred
  - Bus Speed (BS). Bit 21 indicates the ARINC-429 bus speed the data is from.
    - 0 = Indicates low-speed ARINC-429 bus (12.5 kHz)
    - 1 = Indicates high-speed ARINC-429 bus (100 kHz)
  - Reserved (R). Bit 20 is reserved.
  - Gap Time (GAP TIME). Bits 19-0 contain a binary value that represents the gap time from the beginning of the preceding bus word (regardless of bus) to the beginning of the current bus word in 0.1- $\mu$ s increments. The gap time of the first word in the packet is GAP TIME = 0. When the gap time is longer than 100 ms, a new packet must be started.
- c. ARINC-429 Packet Data Words. The data words shall be inserted into the packet in the original 32-bit format as acquired from the bus.

11.2.9 Message Data Packets

11.2.9.1 Message Data Packets, Format 0

The data from one or more separate serial communication interface channels can be placed into a message data packet ([Table 11-37](#)).

<b>Table 11-37. Message Data Packet Format</b>	
msb	lsb
15	0
Packet Header	
Channel-Specific Data (Bits 15-0)	
Channel-Specific Data (Bits 31-16)	
Intra-Packet Time Stamp for Msg 1 (Bits 15-0)	
Intra-Packet Time Stamp for Msg 1 (Bits 31-16)	
Intra-Packet Time Stamp for Msg 1 (Bits 47-32)	
Intra-Packet Time Stamp for Msg 1 (Bits 63-48)	
Intra-Packet Data Header for Msg 1 (Bits 15-0)	
Intra-Packet Data Header for Msg 1 (Bits 31-16)	
Byte 2	Byte 1
:	:
Filler (if N is Odd)	Byte N
:	
Intra-Packet Time Stamp for Msg N (Bits 15-0)	
Intra-Packet Time Stamp for Msg N (Bits 31-16)	
Intra-Packet Time Stamp for Msg N (Bits 47-32)	
Intra-Packet Time Stamp for Msg N (Bits 63-48)	
Intra-Packet Data Header for Msg N (Bits 15-0)	
Intra-Packet Data Header for Msg N (Bits 31-16)	
Byte 2	Byte 1
:	:
Filler (if N is Odd)	Byte N
Packet Trailer	

- a. Message Packet Channel-Specific Data Word. The packet body portion of each message data packet begins with a CSDW. It indicates if the packet body contains several short messages (type: complete) or one segment of a long message (type: segmented).
- b. Complete Message Channel-Specific Data Word. The CSDW is formatted for the complete type of packet body as shown in [Figure 11-46](#).

msb	lsb
31	0
18 17 16 15	
RESERVED	TYPE COUNTER

Figure 11-46. Complete Message Channel-Specific Data Word

- Reserved. Bits 31-18 are reserved.

- Type. Bits 17-16 indicate the type of serial packet.
    - 00 = One or more complete messages
    - 01 = Reserved
    - 10 = Reserved
    - 11 = Reserved
  - Counter. Bits 15-0 contain a binary value indicating the number of messages included in the packet.
- c. Segmented Message Channel-Specific Data Word. The CSDW is formatted for the segmented type of packet body as shown in [Figure 11-47](#).

msb							lsb
31		18	17	16	15		0
RESERVED			TYPE		COUNTER		

Figure 11-47. Segmented Message Channel-Specific Data Word

- Reserved. Bits 31-18 are reserved.
  - Type. Bits 17-16 indicate the type of serial packet.
    - 00 = Reserved
    - 01 = Packet is a beginning of a long message from a single source
    - 10 = Whole packet is the last part of a long message from a single source
    - 11 = Whole packet is a middle part of a long message from a single source
  - Counter. Bits 15-0 contain a binary value indicating the segment number of a long message. The number must start with 1 and must be incremented by one after each packet. The maximum length of a single long message is 4 gigabytes (combined with the 16-bit Message Length field; see description in item d below).
- d. Message Data Intra-Packet Header. After the channel-specific data, message data is inserted into the packet. Each message is preceded by an IPH that has both an IPTS and an IPDH containing a message ID word. The length of the IPH is fixed at 12 bytes (96 bits) positioned contiguously, in the sequence shown in [Figure 11-48](#).

msb							lsb
31							0
Time (LSLW)							
Time (MSLW)							
Message ID Word							

Figure 11-48. Message Data Intra-Packet Header

- Intra-Packet Time Stamp. These 8 bytes indicate the time tag of the message data. First long word bits 31-0 and second long word bits 31-0 indicate the following values.
  - (3) The 48-bit RTC that corresponds to the first data bit in the message with bits 31 to 16 in the second long word zero-filled; or

- (4) The absolute time, if enabled by bit 6 in the packet flags (Subsection [11.2.1.1](#) item [g](#)). The time format is indicated by bits 2 and 3 in the packet flags (Subsection [11.2.1.1](#) item [g](#)). The time tag shall be correlated to the first data bit in the message.
- Intra-Packet Data Header. The IPDH is an identification word (message ID word) that precedes the message and is inserted into the packet with the format shown in [Figure 11-49](#).

msb			lsb		
31	30	29	16	15	0
DE	FE	SUBCHANNEL		MESSAGE LENGTH	

Figure 11-49. Intra-Packet Data Header Format

- Data Error (DE). Bit 31 indicates bad data bits as determined by parity, checksums, or cyclic redundancy check words received with the data.
  - 0 = No data error has occurred
  - 1 = Data error has occurred
- Format Error (FE). Bit 30 indicates a protocol error, such as out-of-sequence data or length errors.
  - 0 = No format error
  - 1 = Format error encountered
- Subchannel. Bits 29-16 contain a binary value that represents the subchannel number belonging to the message that follows the ID word when the channel ID in the packet header defines a group of subchannels. Zero means first and/or only subchannel.
- Message Length. Bits 15-0 contain a binary value representing the length of the message in bytes (*n*) that follows the ID word. The maximum length of a message (complete) or a message segment (segmented) is 64 KB.

#### 11.2.10 Video Packets



**NOTE**

This release contains an almost complete rewrite of the video data types. This release takes advantage of the embedded video transport stream’s capability to self-document its video structure. The current video type attributes, bits and other fields are used for CH10/CH11 information use only. It documents what is here without having to read the TS directly.

Formats 0, 1, and 2 are all used to carry “packetized elementary streams”, and differ only slightly; Format 0 is a legacy format with atypical byte ordering options and limitations on the size and quality of the video that can be carried, while Format 1 and Format 2 are synonymous, although in previous editions of this standard each one imposed different restrictions on their usage.

Format 3 has been deprecated, while Format 4 encodes video data as a sequence of standalone image frames encoded using JPEG2000 compression. The latter should not be confused with MPEG TSs using JPEG2000 compression, which shall be encapsulated in Format 2.



**NOTE**

Care should be taken to avoid confusion when using abbreviations as multiple meanings may be inferred depending on context. For example “MPEG-4” could reasonably refer to a file format, one of two video compression standards or one of several other technologies published under the same “umbrella”.

### 11.2.10.1 Video Packets, Format 0 (Legacy)

Format 0 (Legacy) embeds MPEG-2 TSs containing “standard definition” video IAW DoD Motion Imagery Standards Board (MISB) Standard 1402.2.<sup>6</sup> The format is restricted to TSs containing Motion Imagery Standards Profile (MISP) 2020.1 Class 1 Motion Imagery for Legacy Systems IAW MISP 2020.1, Subsection 3.6.3.4, Table 7.<sup>7</sup>

The TSs carried using Format 0 (Legacy) are limited to a single-program TS IAW MISB ST 1402.2.

A packet with Format 0 (Legacy) video data has the basic structure shown in [Table 11-38](#). Note that the width of the structure is not related to any number of bits. This figure is merely intended to represent relative placement of data in the packet.

<b>Table 11-38. General MPEG-2/H.264 Video Packet, Format 0</b>
Packet Header
Channel-Specific Data
(Optional) Intra-Packet Header
188-Byte TS Data
(Optional) Intra-Packet Header
188-Byte TS Data
:
(Optional) Intra-Packet Time Header
188-Byte TS Data
(Optional) Intra-Packet Time Header
188-Byte TS Data
Packet Trailer

- a. Video Packet Audio. Audio may be included in the TS IAW MISB ST 1001.1.<sup>8</sup>
- b. Video Packet Channel-Specific Data Word. The packet body portion of each Format 0 packet begins with the CSDW, formatted as shown in [Figure 11-50](#). Note that the CSDW bits are informative only, and indicators elsewhere (e.g., in the TS) should be taken as definitive.

<sup>6</sup> Motion Imagery Standards Board. *MPEG-2 Transport of Compressed Motion Imagery and Metadata*. ST 1402.2. 27 February 2014. May be superseded by update. Retrieved 10 May 2021. Available at <https://gwg.nga.mil/misb/docs/standards/ST1402.pdf>.

<sup>7</sup> Motion Imagery Standards Board. *Motion Imagery Standards Profile*. MISP-2020.1. October 2019. May be superseded by update. Retrieved 13 July 2021. Available at <https://gwg.nga.mil/misb/docs/misp/MISP-2020.1.pdf>.

<sup>8</sup> Motion Imagery Standards Board. *Audio Encoding*. ST 1001.1. 27 February 2014. May be superseded by update. Retrieved 10 May 2021. Available at <https://www.gwg.nga.mil/misb/docs/standards/ST1001.1.pdf>.



msb						lsb	
31	30	29	28	24	23	22	0
R	IPH	SRS	RESERVED	BA	RESERVED		

Figure 11-50. Video Packet Channel-Specific Data Word

- **Reserved (R).** Bit 31 is reserved. The functionality of this bit in previous versions is available through the setup record.
- **Intra-Packet Header.** Bit 30 indicates if IPTSs are inserted before each transport packet.
  - 0 = Intra-packet times not present
  - 1 = Intra-packet times present
- **STC/RTC Sync (SRS).** Bit 29 indicates if the TS system time clock (STC) is based on the packet's RTC.
  - 0 = STC is not synchronized with the 10-MHz RTC
  - 1 = STC is synchronized with the 10-MHz RTC

The TSs contain a single time source referred to as the STC, which is based on a 27-MHz clock. Timing synchronization between the video source and the video display is managed by means of program clock reference (PCR) values inserted in the stream. The 10-MHz RTC in the Format 0 packet header is for the purposes of synchronizing and time-stamping data acquired from multiple input sources.

In order to relate the two different timing models, the video STC and the PCR time values may be linked to the RTC reference source (by generating the 27-MHz STC slaved to the 10-MHz RTC or vice versa).

For recording periods of less than 26.5 hours, the STC can be directly compared with the RTC using the equation:

$$\text{RTC} = \text{STC} * 10/27 \text{ (rounded to nearest integer)}$$

For recording periods longer than this, the Format 0 packet header time stamp can be used to determine the number of times the TS system clock reference (SCR) has rolled over and calculate the upper 8 bits of the free-running counter's value.

- **Reserved.** Bits 28-24 are reserved. The functionality of these bits in previous versions is available through the setup record.
- **Byte Alignment (BA).** Bit 23 indicates the MPEG-2 data payload byte alignment within 16-bit words.
  - 0 = Little-endian as referenced in [Figure 11-51](#).
  - 1 = Big-endian as referenced in [Figure 11-52](#).

msb	lsb
15	0
TS Sync Byte (Bits 0 to 7)	TS Data (Bits 8 to 15)
TS Data (Bits 16 to 23)	TS Data (Bits 24 to 31)
:	
TS Data (Bits 1488 to 1495)	TS Data (Bits 1496 to 1503)

Figure 11-51. Format 0 (Legacy) Video Frame Format, 16-Bit Little-Endian Aligned

msb	lsb
15	0
TS Data (Bits 8 to 15)	TS Sync Byte (Bits 0 to 7)
TS Data (Bits 24 to 31)	TS Data (Bits 16 to 23)
:	
TS Data (Bits 1496 to 1503)	TS Data (Bits 1488 to 1495)

Figure 11-52. Format 0 (Legacy) Video Frame Format, 16-Bit Big-Endian (Native) Aligned

- Reserved. Bits 22-0 are reserved.
- c. Intra-Packet Header. If enabled, the IPH shall include a 64-bit IPTS, which is inserted immediately before the TS sync pattern. The length of the IPH is fixed at 8 bytes (64 bits) positioned contiguously, in [Figure 11-53](#).

msb	lsb
31	0
Time (LSLW)	
Time (MSLW)	

Figure 11-53. Video Packet, Format 0 Intra-Packet Header

- Intra-Packet Time Stamp. These 8 bytes indicate the time tag of the individual TS packets. Note that this time tag may not correspond precisely to an external event due to the variable latency of video and audio compression systems. First long word (LSLW) bits 31-0 and second long word (MSLW) bits 31-0 indicate the following values.

- (1) The 48-bit RTC that will correspond to the first bit of the TS. Bits 31 to 16 in the second long word (MSLW) will be zero filled; or
- (2) The absolute time, if enabled by bit 6 in the packet flags (Subsection [11.2.1.1](#) item [g](#)). The time format is indicated by bits 2 and 3 in the packet flags (Subsection [11.2.1.1](#) item [g](#)). The time tag shall be correlated to the first bit of the TS.

- d. Video Packet Data. A Format 0 (Legacy) packet shall contain an integral number of ST 1402.2-compliant 188-byte (1504 bits) TS packets as illustrated in [Figure 11-51](#) and [Figure 11-52](#) (depending on the byte alignment). The IPHs can be inserted in Format 0 video data packets. The Chapter 11 header RTC refers to the first bit of the TS data in the Chapter 11 packet.



Each fixed-length 188-byte TS packet contains an 8-bit sync bite with a value of 01000111 (0X47). The rest of the TS 187 data bytes will follow ([Table 11-39](#)).

<b>Table 11-39. Format 0 MPEG-2/H.264 Video Data Packet</b>	
(Example is 16-Bit Aligned)	
msb	lsb
15	0
<b>Packet Header</b>	
Channel-Specific Data (Bits 15-0)	
Channel-Specific Data (Bits 31-16)	
(Optional) Intra-Packet Time Stamp	
TS Sync Byte Data (Bits 15 to 0)	
TS Data (Bits 31 to 16)	
:	
TS Data (Bits 1487 to 1472)	
TS Data (Bits 1503 to 1488)	
(Optional) Intra-Packet Time Stamp	
TS Sync Byte Data (Bits 15 to 0)	
TS Data (Bits 31 to 16)	
:	
TS Data (Bits 1487 to 1472)	
TS Data (Bits 1503 to 1488)	
:	
(Optional) Intra-Packet Time Stamp	
Repeat for each TS.	
:	
<b>Packet Trailer</b>	

#### 11.2.10.2 Video Packets, Format 1 (Deprecated)

Format 1 is deprecated and superseded by Format 2. Historically, Format 1 was used for streams using MPEG-2 video encoding, while Format 2 was used for other codecs such as H.264. However, structurally the two formats are identical and either format might be used to embed any video codec type.





11.2.10.3 Video Packets, Format 2 (MPEG-2 Stream)

Format 2 encapsulates MPEG-2 streams, both TSs IAW MISB ST 1402.2 and program streams<sup>9</sup> IAW ISO/IEC standard 13818-1<sup>10</sup>/ITU-T H.222.0.<sup>11</sup> (Note that the ISO/IEC and ITU-T standards are harmonized and equivalent.)

- a. MPEG-2 Stream Packet Body. The Format 2 packet has the basic structure shown in [Table 11-40](#). An integral number of complete MPEG-2 stream packets will be in each Format 2 packet. Note that the width of the structure is not related to any number of bits. This table is merely intended to represent relative placement of data in the packet.

<b>Table 11-40. General AVC/H.264 Video Packet, Format 2</b>
Packet Header
Channel-Specific Data
(Optional) Intra-Packet Header
MPEG-2 Stream Packet 1
(Optional) Intra-Packet Header
MPEG-2 Stream Packet 2
:
(Optional) Intra-Packet Header
MPEG-2 Stream Packet <i>n</i>
Packet Trailer

- b. Video Packet Audio. Audio may be included in TSs IAW MISB ST 1001.1. Audio may also be included in program streams using mechanisms uncontrolled by this standard.
- c. Video Packet Metadata. The TS KLV metadata, if utilized, will be IAW MISB ST 1402.2 and the related MISP requirements. The KLV metadata for program streams is uncontrolled by this standard.
- d. Video Packet Channel-Specific Data Word. The packet body portion of each MPEG-2 stream video begins with a CSDW formatted as shown in [Figure 11-54](#).

msb	lsb
31 27 26	21 20 19 18
13 12	11 0
R	RESERVED
SRS	IPH
RESERVED	TP
RESERVED	RESERVED

Figure 11-54. MPEG-2 Stream Channel-Specific Data Word

- Reserved (R). Bits 31-27 are reserved for future use.

<sup>9</sup> The use of program streams is strongly discouraged as they are inherently designed for use with reliable, lossless media such as DVDs.

<sup>10</sup> ISO/IEC. *Information technology – Generic coding of moving pictures and associated audio information: Part 1: Systems – Technical Corrigendum 1*. ISO/IEC 13818-1:2019/COR 1:2020. October 2020. May be superseded by update. Retrieved 10 May 2021. Available for purchase at <https://www.iso.org/standard/75928.html>.

<sup>11</sup> International Telecommunications Union. *Information technology: Generic coding of moving pictures and associated audio information: Systems*. ITU-T REC.H.222.0. 29 August 2018. May be superseded by update. Retrieved 10 May 2021. Available for purchase from <https://www.itu.int/rec/T-REC-H.222.0-201808-I>.



- Reserved. Bits 26-21 were used in previous editions of this standard, but have been removed as having no meaning in this release.
- SCR/RTC Sync (SRS). Bit 20 indicates whether the AVC/H.264 MPEG-2 SCR is RTC.

- 0 = SCR is not synchronized with the 10 MHz RTC.
- 1 = SCR is synchronized with the 10 MHz RTC.



The TSs contain a single time source, referred to as the STC, which is based on a 27-MHz clock. Timing synchronization between the video source and the video display is managed by means of PCR or SCR values inserted into the stream (PCR for TSs, SCR for program streams). The 10-MHz RTC in the Format 2 packet header is for the purposes of synchronizing and time-stamping data acquired from multiple input sources.

In order to relate the two different timing models, the video STC and the PCR time values may be linked to the RTC reference source (by generating the 27-MHz STC slaved to the 10-MHz RTC or vice versa).

For recording periods of less than 26.5 hours, the STC can be directly compared with the RTC using the following equation.

$$\text{RTC} = \text{STC} * 10/27 \text{ (rounded to the nearest integer)}$$

For recording periods longer than this, the Format 2 packet header time stamp can be used to determine the number of times the TS SCR has rolled over and calculate the upper 8 bits of the free-running counter's value.

- Intra-Packet Header (IPH). Bit 19 indicates whether IPHs are inserted before each MPEG-2 stream packet.
- Undefined. Bits 18-13 were used in previous editions of this standard, but have no meaning in this edition. Any value is permissible.
- Type (TP). Bit 12 indicates the type of data the packetized AVC/H.264 MPEG-2 bit stream contains.

- 0 = Transport data stream
- 1 = Program data stream



- Reserved. Bits 11-0 were used in previous editions of this standard, but have no meaning in this edition.

- e. Intra-Packet Header. If enabled, the IPH shall include a 64-bit IPTS, which is inserted immediately before the MPEG-2 stream (transport or program). The length of the IPH is fixed at 8 bytes (64 bits) positioned contiguously, in the following sequence ([Figure 11-55](#)).

msb	lsb
31	0
Time (LSLW)	
Time (MSLW)	

Figure 11-55. Video Packet, Format 2 Intra-Packet Header





- **Intra-Packet Time Stamp.** These 8 bytes indicate the time tag of the individual TS packet. Note that this time tag may not correspond precisely to an external event due to the variable latency of video and audio compression systems. First long word (LSLW) bits 31-0 and second long word (MSLW) bits 31-0 indicate the following values.
  - The 48-bit RTC that will correspond to the first bit of the MPEG-2 stream data. Bits 31 to 16 in the second long word (MSLW) will be zero-filled; or
  - The absolute time, if enabled by bit 6 in the packet flags (Subsection [11.2.1.1](#) item [g](#)). The time format is indicated by bits 2 and 3 in the packet flags (Subsection [11.2.1.1](#) item [g](#)). The time tag shall be correlated to the first bit of the MPEG-2 stream packet.

#### 11.2.10.4 Video Packets, Format 3 (Deprecated)

Format 3 is deprecated. Historically, Format 3 was intended for streams using Motion JPEG encoding. This format has been deprecated due to a lack of formal standardization and the effective obsolescence of the encoding technique.

#### 11.2.10.5 Video Packets, Format 4 (MJPEG-2000).

Format 4 video encoding will be IAW ISO/IEC 15444-3:2007 Motion JPEG 2000.<sup>12</sup> A set of images for this type with compatible parameters can be placed into an MJPEG-2000 video packet as shown in [Table 11-41](#).

<b>Table 11-41. MJPEG Video Packet, Format 4</b>	
msb 15	lsb 0
PACKET HEADER	
CHANNEL-SPECIFIC DATA (BITS 15-0)	
CHANNEL-SPECIFIC DATA (BITS 31-16)	
INTRA-PACKET HEADER FOR SEGMENT 1 (BITS 15-0)	
INTRA-PACKET HEADER FOR SEGMENT 1 (BITS 31-16)	
INTRA-PACKET HEADER FOR SEGMENT 1 (BITS 47-32)	
INTRA-PACKET HEADER FOR SEGMENT 1 (BITS 63-48)	
INTRA-PACKET HEADER FOR SEGMENT 1 (BITS 79-64)	
INTRA-PACKET HEADER FOR SEGMENT 1 (BITS 95-80)	
FRAME BYTE 2	FRAME BYTE 1
:	:
FILLER (IF $n$ IS ODD)	FRAME BYTE $n$
:	
INTRA-PACKET HEADER FOR SEGMENT $n$ (BITS 15-0)	
INTRA-PACKET HEADER FOR SEGMENT $n$ (BITS 31-16)	
INTRA-PACKET HEADER FOR SEGMENT $n$ (BITS 47-32)	
INTRA-PACKET HEADER FOR SEGMENT $n$ (BITS 63-48)	

<sup>12</sup> ISO/IEC. *Information technology: JPEG 2000 image coding system: motion JPEG 2000*. ISO/IEC 15444-3:2007. Geneva: International Organization for Standardization, 2007.

INTRA-PACKET HEADER FOR SEGMENT 1 (BITS 79-64)	
INTRA-PACKET HEADER FOR SEGMENT $n$ (BITS 95-80)	
FRAME BYTE 2	FRAME BYTE 1
:	:
FILLER (IF $n$ IS ODD)	FRAME BYTE $n$
PACKET TRAILER	

An MJPEG-2000 video packet shall contain one or more fixed-length segments of a partial MJPEG-2000 frame, one complete MJPEG-2000 frame, or multiple complete MJPEG-2000 frames.

MJPEG-2000 video packet information will be specified in the CSDW.

- a. MJPEG-2000 Video Packet Channel-Specific Data Word. The packet body portion of each MJPEG-2000 video packet begins with a CSDW. It indicates if the packet body contains several complete images or partial images ([Figure 11-56](#)).

msb						lsb		
31	30	29	28	27	26	0		
PARTS	SUM	IPH	RESERVED					

Figure 11-56. MJPEG 2000 Video Packet Channel-Specific Data Word

- Parts. Bits 31-30 indicate which segment of the frames is contained in the packet if the packet does not contain one or more complete frames.
    - 00 = Packet does not contain first or last segment of frame
    - 01 = Packet contains first segment of frame
    - 10 = Packet contains last segment of frame
    - 11 = Reserved
  - Sum. Bits 29-28 indicate if the packet contains a partial frame that spans multiple packets, one complete frame, or multiple complete frames.
    - 00 = Packet contains less than one complete frame (a segment)
    - 01 = Packet contains one complete frame
    - 10 = Packet contains multiple complete frame
    - 11 = Reserved
  - Intra-Packet Header (IPH). Bit 27 indicates that the IPH (time stamp/data) shall precede each complete frame within a packet or the first segment of a multi-segment frame. An IPH (time stamp) is not required for a frame segment if it is not the first segment of a frame.
    - 0 = Intra-Packet Header not enabled
    - 1 = Intra-Packet Header enabled
  - Reserved. Bits 26-0 are reserved.
- b. MJPEG 2000 Video Intra-Packet Header. After the CSDW, the format 4 MJPEG-2000 video data (complete frame, multiple complete frames, or frame segment) is inserted into the packet. The frame shall be preceded by an IPH, which shall provide the complete

frame or first frame segment time stamp and the frame length. The IPH time stamp value indicates the time of the complete frame capture.

The IPH consists of an IPTS and intra-packet data. The length of the IPH is fixed at 12 bytes (96 bits) positioned contiguously, in the following sequence ([Figure 11-57](#)).

msb	lsb
31	0
TIME (LSLW)	
TIME (MSLW)	
FRAME LENGTH	

Figure 11-57. MJPEG Video Intra-Packet Header

- **Intra-Packet Time Stamp (TIME)**. These 8 bytes indicate the time tag of the Format 4 MJPEG-2000 video data. First long word bits 31-0 and second long word bits 31-0 indicate the following values:
  - The 48-bit RTC that corresponds to the first data bit in the MJPEG-2000 frame with bits 31 to 16 in the second long word zero filled or;
  - The absolute time, if enabled by bit 6 in the packet flags (Subsection [11.2.1.1](#) item [g](#)). The time format is indicated by bits 2 and 3 in the packet flags (Subsection [11.2.1.1](#) item [g](#)). The time tag shall be correlated to the first data bit in the MJPEG-2000 frame.
- **Intra-Packet Data (FRAME LENGTH)**. These 4 bytes indicate a binary value that represents the byte length of the following complete frame.

### 11.2.11 Image Packets

#### 11.2.11.1 Image Packets, Format 0 (Image Data)

A Format 0 image packet ([Table 11-42](#)) shall contain one or more fixed-length segments of one or more video images. The CSDW for an image packet identifies the number of segments in the packet and the portion of the image or images contained in the packet. If the optional IPH is not included with each segment, the RTC in the packet header is the time of the first segment in the packet.

<b>Table 11-42. Image Packet, Format 0</b>	
msb	lsb
15	0
Packet Header	
Channel-Specific Data (Bits 15-0)	
Channel-Specific Data (Bits 31-16)	
Optional Intra-Packet Header for Segment 1 (Bits 15-0)	
Optional Intra-Packet Header for Segment 1 (Bits 31-16)	
Optional Intra-Packet Header for Segment 1 (Bits 47-32)	
Optional Intra-Packet Header for Segment 1 (Bits 63-48)	
Byte 2	Byte 1
:	:

Filler (if N is Odd)	Byte N
:	
Optional Intra-Packet Header for Segment N (Bits 15-0)	
Optional Intra-Packet Header for Segment N (Bits 31-16)	
Optional Intra-Packet Header for Segment N (Bits 47-32)	
Optional Intra-Packet Header for Segment N (Bits 63-48)	
Byte 2	Byte 1
:	:
Filler (if N is Odd)	Byte N
Packet Trailer	

- a. **Image Packet Channel-Specific Data Word.** The packet body portion of each image packet begins with a CSDW. It defines the byte length of each segment and indicates if the packet body contains several complete images or partial images, and whether or not the IPDH precedes each segment ([Figure 11-58](#)).

msb						lsb
31	30	29	28	27	26	0
PARTS	SUM	IPH	LENGTH			

Figure 11-58. Image Packet Channel-Specific Data Word

- **Parts.** Bits 31-30 indicate which piece or pieces of the video frame are contained in the packet.
    - 00 = Packet does not contain first or last segment of image
    - 01 = Packet contains first segment of image
    - 10 = Packet contains last segment of image
    - 11 = Packet contains both first and last segment of image
  - **Sum.** Bits 29-28 indicate if the packet contains a partial image, one complete image, multiple complete images, or pieces from multiple images.
    - 00 = Packet contains less than one complete image
    - 01 = Packet contains one complete image
    - 10 = Packet contains multiple complete images
    - 11 = Packet contains multiple incomplete images
  - **Intra-Packet Header (IPH).** Bit 27 indicates whether the IPH (time stamp) precedes each segment of the image.
    - 0 = The IPH not enabled
    - 1 = The IPH enabled
  - **Length.** Bits 26-0 indicate a binary value that represents the byte length of each segment.
- b. **Image Intra-Packet Header.** After the channel-specific data, Format 0 image data is inserted into the packet. Each block of data is optionally preceded by an IPH as indicated by the IPH bit in the CSDW. When included, the IPH consists of an IPTS only. The

length of the IPH is fixed at 8 bytes (64 bits) positioned contiguously, in the following sequence ([Figure 11-59](#)).

msb	lsb
31	0
Time (LSLW)	
Time (MSLW)	

Figure 11-59. Image Data Intra-Packet Header, Format 0

- **Intra-Packet Time Stamp.** These 8 bytes indicate the time tag of the Format 0 image data. First long word bits 31-0 and second long word bits 31-0 indicate the following values.
  - The 48-bit RTC that corresponds to the first data bit in the first byte with bits 31 to 16 in the second long word zero-filled; or
  - The absolute time, if enabled by bit 6 in the packet flags (Subsection [11.2.1.1](#) item [g](#)). The time format is indicated by bits 2 and 3 in the packet flags (Subsection [11.2.1.1](#) item [g](#)). The time tag shall be correlated to the first data bit in the image or segment.

11.2.11.2 Image Packets, Format 1 (Still Imagery)

A Format 1 image packet ([Table 11-43](#)) shall contain one or more fixed-length segments of a partial still image, one complete still image, or multiple still images. The still image source can be external or internal to the recorder. The still image formats will be specified in the CSDW and in the Computer-Generated Data, Format 1 setup record for each still imagery channel. Only one format can be contained within each channel ID for still imagery.

<b>Table 11-43. Still Imagery Packet, Format 1</b>	
msb	lsb
15	0
<b>Packet Header</b>	
Channel-Specific Data (Bits 15-0)	
Channel-Specific Data (Bits 31-16)	
Intra-Packet Header for Segment 1 (Bits 15-0)	
Intra-Packet Header for Segment 1 (Bits 31-16)	
Intra-Packet Header for Segment 1 (Bits 47-32)	
Intra-Packet Header for Segment 1 (Bits 63-48)	
Intra-Packet Header for Segment 1 (Bits 79-64)	
Intra-Packet Header for Segment 1 (Bits 95-80)	
Byte 2	Byte 1
:	:
Filler (if N is Odd)	Byte N
:	
Intra-Packet Header for Segment N (Bits 15-0)	
Intra-Packet Header for Segment N (Bits 31-16)	
Intra-Packet Header for Segment N (Bits 47-32)	

Intra-Packet Header for Segment N (Bits 63-48)	
Intra-Packet Header for Segment 1 (Bits 79-64)	
Intra-Packet Header for Segment N (Bits 95-80)	
Byte 2	Byte 1
:	:
Filler (if N is Odd)	Byte N
Packet Trailer	

- a. **Still Imagery Packet Channel-Specific Data Word.** The packet body portion of each still image packet begins with a CSDW. It defines the format of the still imagery format (which will coincide with the still imagery format with the setup record), and indicates if the packet body contains several complete images or partial images ([Figure 11-60](#)).

msb								lsb
31	30	29	28	27	26	23	22	0
PARTS		SUM		IPH	FORMAT		RESERVED	

Figure 11-60. Still Imagery Packet Channel-Specific Data Word

- **Parts.** Bits 31-30 indicate which piece or pieces of the image are contained in the packet.
  - 00 = Packet does not contain first or last segment of image
  - 01 = Packet contains first segment of image
  - 10 = Packet contains last segment of image
  - 11 = Packet contains both first and last segment of image
- **Sum.** Bits 29-28 indicate if the packet contains a partial image, one complete image, multiple complete images, or pieces from multiple images.
  - 00 = Packet contains less than one complete image
  - 01 = Packet contains one complete image
  - 10 = Packet contains multiple complete images
  - 11 = Packet contains multiple incomplete images
- **Intra-Packet Header (IPH).** Bit 27 indicates whether the IPH (time stamp) precedes each segment of the image.
  - 0= The IPH not enabled
  - 1= The IPH enabled
- **Format.** Bits 26-23 indicate a binary value that represents the still image format.
  - 0000 = MIL-STD-2500<sup>13</sup> National Imagery Transmission Format
  - 0001 = JPEG File Interchange Format

<sup>13</sup> Department of Defense. "National Imagery Transmission Format Version 2.1." MIL-STD-2500C w/Change 2. 2 January 2019. May be superseded by update. Retrieved 17 May 2021. Available at [https://quicksearch.dla.mil/qsDocDetails.aspx?ident\\_number=112606](https://quicksearch.dla.mil/qsDocDetails.aspx?ident_number=112606).



0010 = JPEG 2000 (ISO/IEC 15444-1)<sup>14</sup>  
 0011 = Portable Network Graphics Format  
 0100-1111 = Reserved

- Reserved. Bits 22-0 are reserved.
- b. Still Imagery Intra-Packet Header. After the channel-specific data, Format 1 still imagery data is inserted into the packet. Each still image or segment is preceded by an IPH. The IPH consists of an IPTS and intra-packet data. The length of the IPH is fixed at 12 bytes (96 bits) positioned contiguously, in the following sequence ([Figure 11-61](#)).

msb	lsb
31	0
Time (LSLW)	
Time (MSLW)	
Intra-Packet Data	

Figure 11-61. Still Imagery Intra-Packet Header

- Intra-Packet Time Stamp. These 8 bytes indicate the time tag of the Format 1 still imagery data. First long word bits 31-0 and second long word bits 31-0 indicate the following values.
  - The 48-bit RTC that corresponds to the first data bit in the still image or segment with bits 31 to 16 in the second long word zero-filled; or
  - The absolute time, if enabled by bit 6 in the packet flags (Subsection [11.2.1.1](#) item [g](#)). The time format is indicated by bits 2 and 3 in the packet flags (Subsection [11.2.1.1](#) item [g](#)). The time tag shall be correlated to the first data bit in the still image or segment.
- Intra-Packet Data. These 4 bytes indicate a binary value that represents the byte length of the following still image or segment.

### 11.2.11.3 Image Packets, Format 2 (Dynamic Imagery).

A Format 2 image packet ([Table 11-44](#)) shall contain one or more fixed-length segments of a partial dynamic image, one complete dynamic image, or multiple complete dynamic images. Typically dynamic image packets will be created from cameras attached to a recorder or cameras that include a recording capability.

<b>Table 11-44. Dynamic Imagery Packet, Format 1</b>	
msb	lsb
15	0
Packet Header	
Channel-Specific Data (Bits 15-0)	

<sup>14</sup> ISO/IEC. *Information Technology -- JPEG 2000 Image Coding System: Core Coding System*. ISO/IEC 15444-1:2016. October 2016. Revised by ISO/IEC 15444:1-2019. Retrieved 17 May 2021. Revised version available for purchase at <https://www.iso.org/standard/78321.html>.

Channel-Specific Data (Bits 31-16)	
Intra-Packet Header for Segment 1 (Bits 15-0)	
Intra-Packet Header for Segment 1 (Bits 31-16)	
Intra-Packet Header for Segment 1 (Bits 47-32)	
Intra-Packet Header for Segment 1 (Bits 63-48)	
Intra-Packet Header for Segment 1 (Bits 79-64)	
Intra-Packet Header for Segment 1 (Bits 95-80)	
Image Byte 2	Image Byte 1
:	:
Filler (if $n$ is Odd)	Image Byte N
:	
Intra-Packet Header for Segment N (Bits 15-0)	
Intra-Packet Header for Segment N (Bits 31-16)	
Intra-Packet Header for Segment N (Bits 47-32)	
Intra-Packet Header for Segment N (Bits 63-48)	
Intra-Packet Header for Segment N (Bits 79-64)	
Intra-Packet Header for Segment N (Bits 95-80)	
Image Byte 2	Image Byte 1
:	:
Filler (if $n$ is Odd)	Image Byte N
Packet Trailer	

Each source of dynamic imagery (camera or sensor) shall have its own individual channel ID value. Multiple sources of dynamic imagery (camera or sensor) shall not share the same channel ID value. Dynamic Imagery, Format 2 is defined as image data that has a rate as opposed to Format 1 still imagery, which does not.

Dynamic image information will be specified in the CSDW and in the Computer-Generated Data, Format 1 setup record for each dynamic imagery channel. Only one dynamic imagery format can be defined for each Format 2 image packet channel ID.

If changes are made to the initial dynamic imagery channel settings in the Computer-Generated Data, Format 1 setup record a new setup record packet shall be created prior to any Format 2 image packets to which the new settings are applied. These changes shall be noted as a setup record configuration change in the Computer-Generated Data, Format 1 setup record CSDW.

- a. Dynamic Imagery Packet Channel-Specific Data Word. The packet body portion of each dynamic image packet begins with a CSDW. It defines the format of the dynamic imagery format (which will coincide with the dynamic imagery format with the setup record) and indicates if the packet body contains several complete images or partial images ([Figure 11-62](#)).

msb									lsb
31	30	29	28	27	26	25	24	23	22
PARTS		SUM		IPH	FORMAT			RESERVED	
									0

Figure 11-62. Dynamic Imagery Packet Channel-Specific Data Word

- Parts. Bits 31-30 indicate which segment of the image is contained in the packet if the packet does not contain one or more complete images.
  - 00 = Packet does not contain first or last segment of image
  - 01 = Packet contains first segment of image
  - 10 = Packet contains last segment of image
  - 11 = Reserved
- Sum. Bits 29-28 indicate if the packet contains a partial image that spans multiple packets, one complete image, or multiple complete images.
  - 00 = Packet contains less than one complete image (a segment)
  - 01 = Packet contains one complete image
  - 10 = Packet contains multiple complete images
  - 11 = Reserved
- Intra-Packet Header (IPH). Bit 27 indicates that the IPH (time stamp/data) shall precede each complete image within a packet or the first segment of a multi-segment image. The time stamp applied to each complete image or first segment of an image is dependent on the time stamp mode as defined in Subsection [11.2.11.3](#) item [b](#). An IPH (time stamp) is not required for an image segment if it is not the first segment of an image.
  - 0= The IPH is not enabled
  - 1= The IPH is enabled
- Format. Bits 26-21 indicate a binary value that represents the dynamic image pixel format IAW GenICam Standard Features Naming Convention v1.5<sup>15</sup> or later and GigE Vision v1.2<sup>16</sup> or later.
  - 0x00 = Mono8
  - 0x01 = Mono8Signed
  - 0x02 = Mono10
  - 0x03 = Mono10Packed
  - 0x04 = Mono12
  - 0x05 = Mono12Packed
  - 0x06 = Mono14
  - 0x07 = Mono16
  - 0x08 = BayerGR8
  - 0x09 = BayerRG8
  - 0x0A = BayerGB8
  - 0x0B = BayerBG8
  - 0x0C = BayerGR10
  - 0x0D = BayerRG10
  - 0x0E = BayerGB10
  - 0x0F = BayerBG10

---

<sup>15</sup> European Machine Vision Association. *GenICam Standard Features Naming Convention*. Version 1.5. November 2011. Retrieved 17 May 2021. Available at [http://www.emva.org/wp-content/uploads/GenICam\\_SFNC\\_1\\_5.pdf](http://www.emva.org/wp-content/uploads/GenICam_SFNC_1_5.pdf).

<sup>16</sup> Automated Imaging Association. *GigE Vision*. Version 1.2. n.d. Retrieved 17 May 2021. Available for download with registration at <https://www.automate.org/a3-content/vision-standards-all-standards-forms>.

0x10 = BayerGR12  
0x11 = BayerRG12  
0x12 = BayerGB12  
0x13 = BayerBG12  
0x14 = BayerGR10Packed  
0x15 = BayerRG10Packed  
0x16 = BayerGB10Packed  
0x17 = BayerBG10Packed  
0x18 = BayerGR12Packed  
0x19 = BayerRG12Packed  
0x1A = BayerGB12Packed  
0x1B = BayerBG12Packed  
0x1C = BayerGR16  
0x1D = BayerRG16  
0x1E = BayerGB16  
0x1F = BayerBG16  
0x20 = RGB8Packed  
0x21 = BGR8Packed  
0x22 = RGBA8Packed  
0x23 = BGRA8Packed  
0x24 = RGB10Packed  
0x25 = BGR10Packed  
0x26 = RGB12Packed  
0x27 = BGR12Packed  
0x28 = RGB16Packed  
0x29 = BGR16Packed  
0x2A = RGB10V1Packed  
0x2B = BGR10V1Packed  
0x2C = RGB10V2Packed  
0x2D = BGR10V2Packed  
0x2E = RGB12V1Packed  
0x2F = RGB565Packed  
0x30 = BGR565Packed  
0x31 = YUV411Packed  
0x32 = YUV422Packed  
0x33 = YUV444Packed  
0x34 = YUYVPacked  
0x35 = RGB8Planar  
0x36 = RGB10Planar  
0x37 = RGB12Planar  
0x38 = RGB16Planar  
0x39-0x3E = Reserved  
0x3F = Device-specific

- Reserved. Bits 20-0 are reserved.
- b. Dynamic Imagery Intra-Packet Header. After the CSDW, the Format 2 dynamic imagery data (complete image, multiple complete images, or image segment) is inserted into the

packet. The image shall be preceded by an IPH; this IPH shall provide the complete image or first image segment time stamp and the image length. The IPH time stamp value indicates the time of the complete image at sensor/camera capture.

The image time stamp characteristics are further defined within the setup record dynamic imagery packet channel attributes. Due to the fact that dynamic imagery may be captured and then packetized post-capture there may be uniqueness in regards to time stamping of the data versus packet header/secondary header values related to the first bit of data within the packet as defined in sections [11.2.1.1](#) item [i](#) and [11.2.1.2](#) item [a](#). Individual image IPH time stamp modes are defined as follows.

- (1) Image Capture Time. The IPH TIME value corresponds to the RTC or absolute time when the image was captured by the sensor/camera. The packet header RTC/packet secondary header values indicate when the first bit of data is placed into the packet. When Image Capture Time mode is indicated in the setup record it is understood there is a delay period between packet header RTC/secondary header time and IPH time.
- (2) Image Packetization Time. The IPH TIME value corresponds to the RTC or absolute time when the image was packetized. The packet header RTC/secondary header values indicate when the first bit of data is placed into the packet. Image packetization time is defined as packetizing image data as it is captured by the sensor/camera. When Image Packetization Time mode is indicated in the setup record it is understood there is not a delay period between packet header RTC/secondary header time and the image IPH time.

The IPH consists of an IPTS and intra-packet data. The length of the IPH is fixed at 12 bytes (96 bits) positioned contiguously, in the following sequence ([Figure 11-63](#)).

msb	lsb
31	0
Time (LSLW)	
Time (MSLW)	
Image Length	

Figure 11-63. Dynamic Imagery Intra-Packet Header

- Intra-Packet Time Stamp (TIME). These 8 bytes indicate the time tag of the Format 2 dynamic imagery data as defined in Section [11.2.11.3](#) item [b](#). First long word bits 31-0 and second long word bits 31-0 indicate the following values.
  - The 48-bit RTC that corresponds to the first data bit in the dynamic image with bits 31 to 16 in the second long word zero-filled; or
  - The absolute time, if enabled by bit 6 in the packet flags (Subsection [11.2.1.1](#) item [g](#)). The time format is indicated by bits 2 and 3 in the packet flags (Subsection [11.2.1.1](#) item [g](#)). The time tag shall be correlated to the first data bit in the dynamic image.
- Intra-Packet Data (IMAGE LENGTH). These 4 bytes indicate a binary value that represents the byte length of following complete image.

11.2.12 UART Data Packets

11.2.12.1 UART Data Packets, Format 0

The data from one or more separate asynchronous serial communication interface channels (RS-232, RS-422, RS-485, etc.) can be placed into a UART data packet as shown in [Table 11-45](#). Note that 9 bit UART data is not supported by this format.

<b>Table 11-45. UART Data Packet Format</b>	
msb	lsb
15	0
<b>Packet Header</b>	
Channel-Specific Data (Bits 15-0)	
Channel-Specific Data (Bits 31-16)	
(Optional) Intra-Packet Time Stamp for UART 1 (Bits 15-0)	
(Optional) Intra-Packet Time Stamp for UART 1 (Bits 31-16)	
(Optional) Intra-Packet Time Stamp for UART 1 (Bits 47-32)	
(Optional) Intra-Packet Time Stamp for UART 1 (Bits 63-48)	
Intra-Packet Data Header (UART ID) for UART 1 (Bits 15-0)	
Intra-Packet Data Header (UART ID) for UART 1 (Bits 31-16)	
Byte 2	Byte 1
:	:
Filler (if <i>n</i> is Odd)	Byte N
:	
(Optional) Intra-Packet Time Stamp for UART N (Bits 15-0)	
(Optional) Intra-Packet Time Stamp for UART N (Bits 31-16)	
(Optional) Intra-Packet Time Stamp for UART N (Bits 47-32)	
(Optional) Intra-Packet Time Stamp for UART N (Bits 63-48)	
Intra-Packet Data Header (UART ID) for UART N (Bits 15-0)	
Intra-Packet Data Header (UART ID) for UART N (Bits 31-16)	
Byte 2	Byte 1
:	:
Filler (if <i>n</i> is Odd)	Byte N
<b>Packet Trailer</b>	

- a. UART Packet Channel-Specific Data Word. The packet body portion of each UART data packet begins with a CSDW as shown in [Figure 11-64](#).

msb	lsb
31	30
0	0
IPH	RESERVED

Figure 11-64. UART Packet Channel-Specific Data Word

- Intra-Packet Header. Bit 31 indicates whether the IPH time stamp is inserted before the UART ID words.

0 = The IPH time stamp not enabled

1 = The IPH time stamp enabled

- Reserved. Bits 30-0 are reserved.
- b. UART Intra-Packet Header. After the channel-specific data, UART data is inserted into the packet. Each block of data shall be preceded by an IPH with optional IPTS and a mandatory UART ID word IPDH. The length of the IPH is either 4 bytes (32 bits) or 12 bytes (96 bits) positioned contiguously, in the following sequence ([Figure 11-65](#)).

msb	lsb
31	0
Time (LSLW)	
Time (MSLW)	
UART ID Word	

Figure 11-65. UART Data Intra-Packet Header

- UART Intra-Packet Time Stamp. These 8 bytes indicate the time tag of the UART data. First long word bits 31-0 and second long word bits 31-0 indicate the following values.
  - The 48-bit RTC that corresponds to the first data bit in the first byte with bits 31 to 16 in the second long word zero-filled; or
  - The absolute time, if enabled by bit 6 in the packet flags (Subsection [11.2.1.1](#) item [g](#)). The time format is indicated by bits 2 and 3 in the packet flags (Subsection [11.2.1.1](#) item [g](#)). The time tag shall be correlated to the first data bit in the message.
- UART Intra-Packet Data Header. The IPDH is a UART ID word that precedes the data and is inserted into the packet with the following format. Inclusion of the IPDH is mandatory and is not controlled by the IPH bit in the CSDW ([Figure 11-66](#)).

msb					lsb
31	30	29	16	15	0
PE	RESERVED	SUBCHANNEL	DATA LENGTH		

Figure 11-66. Intra-Packet Data Header Format

- Parity Error (PE). Bit 31 indicates a parity error.
  - 0 = No parity error
  - 1 = Parity error
- Reserved. Bit 30 is reserved.
- Subchannel. Bits 29-16 indicate a binary value defining the subchannel number belonging to the data that follows the UART ID word when the channel ID in the packet header defines a group of subchannels. Zero means first and/or only subchannel into which the IPDH is inserted before the UART ID words.
- Data Length. Bits 15-0 indicate a binary value representing the length of the UART data in bytes (*n*) that follows the UART ID word.

11.2.13 IEEE 1394 Data Packets

11.2.13.1 IEEE 1394 Data Packets, Format 0(IEEE 1394 Transaction)

This format applies to IEEE 1394 data as described by IEEE 1394-2008.<sup>17</sup> The IEEE 1394 data is packetized to encapsulate completed transactions between nodes. A packet may contain 0 to 65,536 transactions, but is constrained by the common packet element size limits prescribed in Subsection [11.2.1](#). The IEEE 1394 packets have the basic structure shown in [Table 11-46](#). Note that the width of the structure is not related to any number of bits. The table merely represents relative placement of data within the packet.

<b>Table 11-46. IEEE 1394 Data Packet, Format 0</b>	
Packet Header	
Channel-Specific Data Word	
(Optional) Intra-Packet Header	
(Optional) Transaction Data	
(Optional) Intra-Packet Header	
(Optional) Transaction Data	
:	
(Optional) Intra-Packet Header	
(Optional) Transaction Data	
Packet Trailer	

- a. IEEE 1394 Channel-Specific Data Word. The packet body portion ([Figure 11-67](#)) of each IEEE 1394 packet shall begin with a CSDW.

msb								lsb			
31	29	28	25	24	16	15	0				
PBT			SY		RESERVED				TC		

Figure 11-67. IEEE 1394 Channel-Specific Data Word

- Packet body Type (PBT). Bits 31-29 indicate the packet body type as follows:
  - 000 = Type 0
  - 001 = Type 1
  - 010 = Type 2
  - 011- 111= Reserved
- Synchronization Code (SY). Bits 28-25 indicate the IEEE 1394 synchronization code from the transaction. This field is mandatory for Type 1 packet bodies. Otherwise, it is reserved.
- Reserved. Bits 24-16 are reserved.
- Transaction Count (TC). Bits 15-0 indicate the binary value of the number of transactions encapsulated in the packet. An integral number of complete transactions

<sup>17</sup> Institute of Electrical and Electronics Engineers. *IEEE Standard for a High-Performance Serial Bus*. IEEE 1394-2008. New York: Institute of Electrical and Electronics Engineers, 2008.



shall be included in each packet. It is mandatory that transaction count be 0 for Type 0 packet bodies and 1 for Type 1 packet bodies.

- b. IEEE 1394 Intra-Packet Header. Each IPH shall contain an 8-byte IPTS only. The format of an IEEE 1394 IPH is described by [Figure 11-68](#).

msb	lsb
31	0
Intra-Packet Time Stamp	
Intra-Packet Time Stamp	

Figure 11-68. IEEE 1394 Intra-Packet Header

- IEEE 1394 Intra-Packet Time Stamp. These 8 bytes indicate the time tag of the IEEE 1394 transaction that immediately follows it in the packet. Time is coded IAW all other Chapter 11 packet formats. Specifically, the first long word bits 31-0 and second long word bits 31-0 indicate the following values.
    - The 48-bit RTC that corresponds to the first data bit of the transaction, with bits 31-16 in the second long word zero-filled; or
    - The absolute time, if enabled by bit 6 in the packet flags (Subsection [11.2.1.1](#) item [g](#)). The time format is indicated by bits 2 and 3 in the packet flags (Subsection [11.2.1.1](#) item [g](#)). The time tag shall be correlated to the first data bit of the transaction.
- c. IEEE 1394 Data Packet Body Types. Three packet body types are defined for the encapsulation of IEEE 1394 data. Regardless of type, each packet body shall begin with the IEEE 1394 packet CSDW as described by Subsection [11.2.13.1](#) item [a](#) above. The packet body type is indicated within the CSDW. Depending on the packet body type, the CSDW is followed by 0 or more transactions. In addition, dependent on packet body type, each transaction may be preceded by an IPH.

- IEEE 1394 Packet Body Type 0: Bus Status. Type 0 packet bodies shall contain zero IPHs and zero transactions. The CSDW transaction count shall be zero. The packet body shall contain the CSDW immediately followed by a single 32-bit word.

Bus status events shall be encapsulated by Type 0 packet bodies. The 32-bit word in the packet body shall contain an event data word as indicated in [Figure 11-69](#).

msb	lsb
31	0
30	0
RE	RESERVED

Figure 11-69. IEEE 1394 Event Data Word

- RESET (RE). Bit 31, when set, indicates that an IEEE 1394 bus reset has occurred.
      - RESERVED. Bits 30-0 are reserved.
  - IEEE 1394 Packet Body Type 1: Data streaming. Type 1 packet bodies shall encapsulate IEEE 1394 data streaming only. Type 1 packet body data is restricted to that from an IEEE 1394 packet with a transaction code of 0xA, be it from an

isochronous channel or asynchronous stream. The packet body shall contain zero IPHs and one transaction. The CSDW transaction count shall be one.

The CSDW is immediately followed by a non-zero number of data bytes. The data bytes shall be exactly those of a single IEEE 1394 data block, excluding the IEEE 1394 packet header and data block CRC. Data recorded from the stream shall be known to be valid, insofar as both the IEEE 1394 header CRC and data block CRC tests have passed. The number of data bytes shall be exactly four less than the value indicated in data length IAW the definition of packet header data length and accounting for the size of the CSDW. Conversely, the value stored in the packet header data length shall be the number of bytes in the IEEE 1394 data block plus four. The synchronization code (SY) from the stream packet shall be indicated in the CSDW, and the channel number shall be indicated in the packet header channel ID.

- **IEEE 1394 Packet Body Type 2: General-Purpose.** Type 2 packet bodies encapsulate complete IEEE 1394 packets, including header and data. Use of Type 2 packet bodies is unrestricted and may encapsulate streaming, non-streaming (IEEE 1394 packets with transaction codes other than 0xA), isochronous, and asynchronous data. Multiple IEEE 1394 packets, with differing transaction codes and channel numbers, may be carried within a single Type 2 packet body.

The CSDW shall be followed by a non-zero number of completed transactions as indicated by the CSDW transaction count. Each transaction shall be preceded by an IPH as defined above for IEEE 1394 data packets. Immediately following the IPH, the transaction shall be recorded in its entirety and must be a properly formed IEEE 1394 packet IAW the specification in use. The revision of the specification used shall be declared within the accompanying setup record packet.

 <p><b>NOTE</b></p>	<p>All IEEE 1394 packets contain a 4-bit Transaction Code field (tcode). This field indicates the IEEE 1394 specific format of the transaction.</p>
--	---

#### 11.2.13.2 IEEE 1394 Data Packets, Format 1 (IEEE 1394 Physical Layer).

This format applies to IEEE 1394 data as described by IEEE 1394-1995, IEEE 1394a, and IEEE 1394b. The IEEE 1394 data is packetized in Format 1 packets as physical layer data transfers (IAW Annex J of Standard 1394-1995<sup>18</sup> and Chapter 17 of Standard 1394b-2002<sup>19</sup>). A packet may contain 0 to 65,536 transfers, but is constrained by the common packet element size limits prescribed in Subsection [11.2.1](#). The IEEE 1394 packets have the basic structure shown in [Table 11-47](#) below. Note that the width of the structure is not related to any number of bits. The drawing merely represents relative placement of data within the packet.

<sup>18</sup> Institute of Electrical and Electronics Engineers. *IEEE Standard for a High Performance Serial Bus*. IEEE 1394-1995. New York: Institute of Electrical and Electronics Engineers, 1995.

<sup>19</sup> Institute of Electrical and Electronics Engineers. *IEEE Standard for a High Performance Serial Bus: Amendment 2*. IEEE 1394b-2002. New York: Institute of Electrical and Electronics Engineers, 2002.

<b>Table 11-47. IEEE 1394 Data Packet, Format 1</b>	
Packet Header	
Channel-Specific Data Word	
Intra-Packet Header	
Data	
(Optional) Intra-Packet Header	
(Optional) Data	
:	
(Optional) Intra-Packet Header	
(Optional) Data	
Packet Trailer	

- a. IEEE 1394 Channel-Specific Data Word. The packet body portion ([Figure 11-70](#)) of each IEEE 1394 packet shall begin with a CSDW.

msb		lsb
31	16 15	0
RESERVED	IPC	

Figure 11-70. IEEE 1394 Channel-Specific Data Word, Format 1

- Reserved. Bits 31-16 are reserved.
  - Intra-Packet Count (IPC). Bits 15-0 indicate the binary value of the number of intra-packets encapsulated in the Chapter 11 packet. An integral number of complete intra-packets shall be included in each Chapter 11 packet.
- b. IEEE 1394 Format 1 Intra-Packet Header. The CSDW is followed by 1 or more IEEE 1394 transfers. Each transfer starts with an IPH, followed by 0-32,780 encapsulated data bytes. The length of the IPH is fixed at 12 bytes (96 bits) positioned contiguously, in the following sequence as shown in [Figure 11-71](#).

msb	lsb
31	0
Intra-Packet Time Stamp	
Intra-Packet Time Stamp	
Intra-Packet ID Word	

Figure 11-71. IEEE 1394 Format 1 Intra-Packet Header

- IEEE 1394 Format 1 Intra-Packet Time Stamp. These 8 bytes indicate the time tag of the IEEE 1394 transfer that immediately follows it in the packet. Time is coded IAW all other Chapter 11 packet formats. Specifically, the first long word bits 31-0 and second long word bits 31-0 indicate the following values.
  - The 48-bit RTC that corresponds to the first data byte of the transfer, with bits 15-0 in the second long word zero-filled; or
  - The absolute time, if enabled by bit 6 in the packet flags (Subsection [11.2.1.1](#) item [g](#)). The time format is indicated by bits 2 and 3 in the packet flags

(Subsection [11.2.1.1](#) item [g](#)). The time tag shall be correlated to the first data byte of the transfer.

- Message ID Word. These 4 bytes are an ID word that precedes the message and is inserted into the packet as in [Figure 11-72](#).

msb										lsb
31		24	23	20	19	18	17	16	15	0
STATUS BYTE			SPEED		TRFOVF		LBO	RSV	DATA LENGTH	

Figure 11-72. Intra-Packet Data Header - Message ID Word

- Status Byte. Bits 31-24 define the status byte received from the physical layer devices IAW IEEE 1394b specification.
- Transmission Speed (SPEED). Bits 23-20 identify the speed of transmission of the message. (Speed codes IAW IEEE 1394b)

0000 = S100 A

0001 = S100 B

0010 = S200 A

0011 = S200 B

0100 = S400 A

0101 = S400 B

0111 = S800 B

1001 = S1600 B

1010 = S3200 B

Other values are reserved

- Transfer Overflow Error (TRFOVF). Bits 19-18 indicate if a transfer synchronization error occurred.
  - 00 = IEEE 1394 flow did not exceed maximum intra-packet size.
  - 01 = This IEEE 1394 transfer started correctly but longer than the standard transfer length.
  - 10 = The previous IEEE 1394 transfer was in 01-type overflow and this IEEE 1394 transfer ended correctly (did not exceed standard transfer length).
  - 11 = The previous IEEE 1394 transfer was in 01-type overflow and this IEEE 1394 transfer did not end correctly (exceeds standard transfer length).

Most of the time, this field shall be 00. Possible combinations are: 01 intra-packet, zero or more; 11 intra-packet; and finally 10 intra-packet.

- Local Buffer Overflow (LBO). Bit 17, if set, indicates that some messages are lost before this transfer due to local buffer overflow.
- Reserved (RSV). Bit 16 is reserved.
- Data Length. Bits 15-0 contain a binary value that represents the length of the transfer in bytes (*n*) that follows the ID word. The maximum length of a

captured data is 4120 for transfers corresponding to asynchronous packets and 32,780 for transfers corresponding to isochronous packets.

If the data length field is not a multiple of 4 bytes, 1-3 fill bytes of 0x00 are added to maintain the packet structures in 32-bit boundary.

If the data length field contains 0, the intra-packet data is not provided and this word contains only the status byte information.

- c. **IEEE 1394 Format 1 Packet Body.** The packet body shall encapsulate IEEE 1394 isochronous or asynchronous message data. The data bytes shall be exactly those of a single IEEE 1394 physical transmission message, including the IEEE 1394 packet header and data block CRC. The data length field shall indicate the exact number of total bytes encapsulated in the message data.

### 11.2.14 Parallel Data Packet

#### 11.2.14.1 Parallel Data Packet, Format 0

Parallel data packets are designed to record data from parallel interfaces (2-128 bit wide) including the industry de facto standard 8-bit Digital Cartridge Recording System – Incremental (DCRsi) interface. A single packet can hold data words or special data structures as currently defined for the DCRsi scan format. The exact format selection is defined in the CSDW. The data recorded from a parallel interface shall be placed into a Parallel Data Packet, Format 0 as shown in [Table 11-48](#).

<b>Table 11-48. Parallel Data Packet, Format 0</b>	
msb	lsb
15	0
Packet Header	
Channel-Specific Data (Bits 15-0)	
Channel-Specific Data (Bits 31-16)	
Data Word 1	
:	
Data Word <i>n</i>	
Packet Trailer	

- a. **Parallel Packet Channel-Specific Data Word.** The packet body portion of each parallel data packet begins with a CSDW. The CSDW is formatted as shown in [Figure 11-73](#).

msb	lsb
31	0
24 23	
TYPE	RESERVED (0) OR SCAN NUMBER

Figure 11-73. Parallel Packet Channel-Specific Data Word

- **Type.** Bits 31-24 indicate the data type stored.
  - 0x01 - 0x00: Reserved
  - 0x80 - 0x02: Number of bits of recorded data (parallel data word width in bits)
  - 0xFD - 0x81: Reserved

0xFE: DCRsi scan format, contains auxiliary data, DCRsi main data  
 0xFF: Reserved

- Scan Number. Bits 23-0 are reserved (0) for general-purpose parallel data packets or contain the scan number of the first scan stored in the packet for DCRsi data.
- b. General-Purpose Parallel Data. General-purpose parallel data packets can contain any number of data bytes, as indicated in the data length field in the packet headers ([Figure 11-74](#)).

msb		lsb	
15		0	
Pad	Data Word 2	Pad	Data Word 1
:		:	
Pad	Data Word <i>n</i> , or Pad if Length is Odd	Pad	Data Word N-1

Figure 11-74. Parallel Data, Up to 8-Bit-Wide Words

 <p><b>NOTE</b></p>	To get the number of data words stored in the packet, the data length must be divided by the number of bytes necessary to hold one parallel data word.
--	--

- If the number of data bits is 8 or less, the word shall be padded with zeros to 8-bit bytes.
- If the number of data bits is between 9 and 16, the words shall be padded with zeros to one 16-bit word, as in [Figure 11-75](#).

msb		lsb	
15		0	
Pad	Data Word 1		
:			
Pad	Data Word N		

Figure 11-75. Parallel Data, 9-Bit to 16-Bit-Wide Words

- If the number of data bits is greater than 16, the words shall be padded with zeros to multiples of 16-bit data words. [Figure 11-76](#) shows storing of 28-bit data words.

msb		lsb	
15		0	
Data Word 1, lsbs 15-0			
Pad	Data Word 1, msbs 27-16		
:			
Data Word N, lsbs 15-0			
Pad	Data Word N, msbs 27-16		

Figure 11-76. Parallel Data (Example: 28-Bit-Wide Words)

- c. DCRsi Parallel Data Packets. The DCRsi data packets can contain any number of complete DCRsi scans, containing 9 auxiliary data and 4356 main data bytes. The

number of the scans can be calculated from the data length field of the packet header. The structure of one DCRsi scan is in [Figure 11-77](#).

msb 15	lsb 0
Auxiliary Data 2	Auxiliary Data 1
Pad (0)	Auxiliary Data 3
Auxiliary Data 5	Auxiliary Data 4
Pad (0)	Auxiliary Data 6
Auxiliary Data 8	Auxiliary Data 7
Pad (0)	Auxiliary Data 9
Data Byte 2	Data Byte 1
Data Byte 4	Data Byte 3
:	:
Data Byte 4356	Data Byte 4355

Figure 11-77. DCRsi Scan, 9-Auxiliary Data Byte + 4326 Bytes

The length of the packet can be only  $N * (12 + 4356) + 4$  bytes, including the length of the CSDW.

Any DCRsi data without auxiliary data bytes can be stored also as 8-bit general-purpose parallel data as described in Subsection [11.2.14](#) item [b](#).

### 11.2.15 Ethernet Data Packets

#### 11.2.15.1 Ethernet Data Packets, Format 0

Data from one or more Ethernet network interfaces can be placed into an Ethernet Data Packet Format 0 as shown in [Table 11-49](#).

<b>Table 11-49. Ethernet Data Packet, Format 0</b>	
msb 15	lsb 0
Packet Header	
Channel-Specific Data (Bits 15-0)	
Channel-Specific Data (Bits 31-16)	
Intra-Packet Time Stamp for Msg 1 (Bits 15-0)	
Intra-Packet Time Stamp for Msg 1 (Bits 31-16)	
Intra-Packet Time Stamp for Msg 1 (Bits 47-32)	
Intra-Packet Time Stamp for Msg 1 (Bits 63-48)	
Intra-Packet Data Header for Msg 1 (Bits 15-0)	
Intra-Packet Data Header for Msg 1 (Bits 31-16)	
Byte 2	Byte 1
:	:
Filler (if $n$ is Odd)	Byte $n$
:	:
Intra-Packet Time Stamp for Msg $n$ (Bits 15-0)	

Intra-Packet Time Stamp for Msg <i>n</i> (Bits 31-16)	
Intra-Packet Time Stamp for Msg <i>n</i> (Bits 47-32)	
Intra-Packet Time Stamp for Msg <i>n</i> (Bits 63-48)	
Intra-Packet Data Header for Msg <i>n</i> (Bits 15-0)	
Intra-Packet Data Header for Msg <i>n</i> (Bits 31-16)	
Byte 2	Byte 1
:	:
Filler (if <i>n</i> is Odd)	Byte <i>n</i>
Packet Trailer	

- a. Ethernet Data Packet Format 0, Channel-Specific Data Word. The packet body portion of each Ethernet data packet begins with a CSDW. It indicates the format of the Ethernet data packet contents, applicable TTBs, and how many media access control (MAC) frames are placed in the packet body. The CSDW is formatted for the complete type of packet body as shown in [Figure 11-78](#).

msb										lsb	
31	28	27	25	24	16	15					0
FORMAT		TTB		RESERVED			NUMBER OF FRAMES				

Figure 11-78. Ethernet Data Packet Format 0 Channel-Specific Data Word

- Format. Bits 31-28 indicate the type of Ethernet packet.
    - 0000 = Ethernet physical layer IEEE 802.3 MAC Frame
    - 0001-1111 = Reserved
  - Time Tag Bits (TTB). Bits 27-25 indicate which bit of the Ethernet MAC frame the IPH time tag is applicable to.
    - 000 = First bit of the MAC frame MAC destination address
    - 001 = Last bit of the MAC frame check sequence
    - 010 = First bit of the MAC frame payload data
    - 011 = Last bit of the MAC frame payload data
    - 100-111 = Reserved
  - Reserved. Bits 24-16 are reserved.
  - Number of Frames. Bits 15-0 contain a binary value that represents the number of frames included in the packet.
- b. Ethernet Data Packet Format 0, Intra-Packet Header. After the channel-specific data, Ethernet data is inserted into the packet. Each frame is preceded by an IPH that has both an IPTS and an IPDH containing a frame ID word. The length of the IPH is fixed at 12 bytes (96 bits) positioned contiguously, in the following sequence as shown in [Figure 11-79](#).



msb	lsb
31	0
Time (LSLW)	
Time (MSLW)	
Frame ID Word	

Figure 11-79. Ethernet Data Format 0 Intra-Packet Header

- **Intra-Packet Time Stamp.** These 8 bytes indicate the time tag of the frame data. First long word bits 31-0 and second long word bits 31-0 indicate the following values.
  - The 48-bit RTC that corresponds to the TTBs in the CSDW of the frame with bits 31 to 16 in the second long word zero-filled; or
  - The absolute time, if enabled by bit 6 in the packet flags (Subsection [11.2.1.1](#) item g). The time format is indicated by bits 2 and 3 in the packet flags (Subsection [11.2.1.1](#) item g). The time tag shall be correlated to the data bit indicated in the TTBs in the CSDW of the frame.
- **Frame ID Word.** The frame ID word is an identification word that precedes the Ethernet frame and is inserted into the packet with the format shown in [Figure 11-80](#).

msb												lsb
31	30	29	28	27	24	23	16	15	14	13		0
FCE	FE	CONTENT	SPEED	NET ID	DCE	LE	DATA LENGTH					

Figure 11-80. Intra-Packet Frame ID Word

- **Frame CRC Error (FCE).** Bit 31, the frame CRC error bit, is used to indicate that a MAC frame CRC error occurred during frame transmission.
  - 0 = No frame CRC error
  - 1 = Frame CRC error encountered
- **Frame Error (FE).** Bit 30, the frame error bit, is used to indicate any error that occurred during frame transmission.
  - 0 = No frame error
  - 1 = Frame error encountered
- **Captured Data Content (CONTENT).** Bits 29-28 specify the extent of the captured MAC frame.
  - 00 = Full MAC frame: starting with the 6-byte destination MAC address and ending with the 4-byte frame check sequence.
  - 01 = Payload (data) only: starting at the 14<sup>th</sup> byte offset from the beginning of the destination MAC address and ending before the 4-byte frame check sequence of the MAC frame.
  - 10 = Reserved for future format.
  - 11 = Reserved for future format.
- **Ethernet Speed (SPEED).** Bits 27-24 indicate the negotiated bit rate for the identified NETID on which the frame was captured.
  - 0000 = Auto

- 0001 = 10 megabits per second (Mbps)
- 0010 = 100 Mbps
- 0011 = 1 gigabit per second (Gbps)
- 0100 = 10 Gbps
- 0101 - 1111 = Reserved

- Network Identifier (NETID). Bits 23-16 contain a binary value that represents the physical network identification of frame origination that follows the ID word. Zero means first and/or only physical network.
- Data CRC Error (DCE). Bit 15, the data CRC error bit, is used to indicate that a CRC error exists in the payload of the frame.
  - 0 = No data CRC error
  - 1 = Data CRC error encountered
- Data Length Error (LE). Bit 14, the data length error bit, is used to indicate that the frame is too short (less than 64 bytes) or too long (longer than 1518 bytes).
  - 0 = Valid length
  - 1 = Data length ID too short or too long.
- Data Length. Bits 13-0 contain a binary value that represents the length of the frame in bytes (*n*) that follows the ID word.

11.2.15.2 Ethernet Data Packets, Format 1, ARINC-664

Any User Datagram Protocol (UDP) packets from Ethernet and/or ARINC-664 Part 7 (referred to as “ARINC-664” in this standard) network interfaces can be placed into an Ethernet Data Packet Format 1 as shown in [Table 11-50](#).

<b>Table 11-50. Ethernet Data Format 1</b>	
msb	lsb
15	0
Packet Header	
Channel-Specific Data (Bits 15-0)	
Channel-Specific Data (Bits 31-16)	
Intra-Packet Time Stamp for Msg 1 (Bits 15-0)	
Intra-Packet Time Stamp for Msg 1 (Bits 31-16)	
Intra-Packet Time Stamp for Msg 1 (Bits 47-32)	
Intra-Packet Time Stamp for Msg 1 (Bits 63-48)	
Intra-Packet Data Header for Msg 1 (Bits 15-0)	
Intra-Packet Data Header for Msg 1 (Bits 31-16)	
Intra-Packet Data Header for Msg 1 (Bits 47-32)	
Intra-Packet Data Header for Msg 1 (Bits 63-48)	
Intra-Packet Data Header for Msg 1 (Bits 79-64)	
Intra-Packet Data Header for Msg 1 (Bits 95-80)	
Intra-Packet Data Header for Msg 1 (Bits 111-96)	
Intra-Packet Data Header for Msg 1 (Bits 127-112)	

Byte 2	Byte 1
:	:
Filler (if $n$ is Odd)	Byte N
:	
Intra-Packet Time Stamp for Msg N (Bits 15-0)	
Intra-Packet Time Stamp for Msg N (Bits 31-16)	
Intra-Packet Time Stamp for Msg N (Bits 47-32)	
Intra-Packet Time Stamp for Msg N (Bits 63-48)	
Intra-Packet Data Header for Msg N (Bits 15-0)	
:	
Intra-Packet Data Header for Msg N (Bits 127-112)	
Byte 2	Byte 1
:	:
Filler (if $n$ is Odd)	Byte N
Packet Trailer	

The ARINC-664 is based on the Ethernet specification, IEEE Standard 802.3-2012.<sup>20</sup> Unlike the Ethernet frame, the last byte of a frame payload is used for the frame sequence number. This byte is located just before the MAC CRC field, as part of the MAC payload. Ethernet Data Packets, Format 1 ARINC-664 shall capture and store the entire ARINC-664 message (the entire UDP payload), including one or more fragmented frames.

The ARINC-664 frame sequence numbers are used by the end system for integrity checking and redundancy management. ARINC-664 requires two redundant switch networks. Each ARINC-664 frame is replicated and sent on both networks. The ARINC-664 receiving end system uses the sequence number to check for dropped frames and to eliminate redundant frames. The link layer of the receiver's ARINC-664 interface discards the sequence number and drops the redundant frame before passing the frame's payload to the Internet Protocol (IP) network layer of the protocol stack. If a UDP datagram is fragmented, the sequence numbers on the fragments are discarded prior to datagram reassembly. [Table 11-51](#) compares a normal Ethernet frame with an ARINC-664 frame.

<b>Table 11-51. Comparison of Normal Ethernet and ARINC-664 Frames</b>						
<b>Normal Ethernet Frame</b>						
7 bytes	1 byte	14 bytes	20 bytes	8 bytes	≤ 1472 bytes	4 bytes
Preamble	Start Delimiter	MAC Header	IP Header	UDP Header	UDP Payload	FCS
<b>ARINC-664 Frame</b>						
7 bytes	1 byte	14 bytes	20 bytes	8 bytes	≤ 1471 bytes	1 byte
						4 bytes

<sup>20</sup> Institute of Electrical and Electronics Engineers. *IEEE Standard for Ethernet*. IEEE 802.3-2012. New York: Institute of Electrical and Electronics Engineers.

Preamble	Start Delimiter	MAC Header	IP Header	UDP Header	ARINC- 664 Payload	Sequence Number	FCS
----------	--------------------	---------------	--------------	---------------	--------------------------	--------------------	-----

- a. Ethernet Data Format 1, Channel-Specific Data Word. The packet body portion of each Ethernet data packet begins with a CSDW. It indicates how many ARINC-664 messages are placed in the packet body. The CSDW is formatted for the complete type of packet body as shown in [Figure 11-81](#).

msb		lsb
31	16 15	0
Intra-Packet Header Length		Number of ARINC-664 Messages

Figure 11-81. Ethernet Data Packet Format 1 Channel-Specific Data Word

- Intra-Packet Header Length. Bits 31-16 contain the length of the IPH in bytes; this is fixed at 28.
  - Number of Messages. Bits 15-0 contain a binary value that represents the number of messages included in the packet.
- b. Ethernet Data Packet Format 1 Intra-Packet Header. After the channel-specific data, ARINC-664 data is inserted into the packet. Each message is preceded by an IPH that has both an IPTS and an IPDH. The length of the IPH is fixed at 28 bytes (224 bits) positioned contiguously, in the following sequence as shown in [Figure 11-82](#).

msb	lsb
31	0
Time (LSLW)	
Time (MSLW)	
Intra-Packet Data Header 1	
Intra-Packet Data Header 2	
Intra-Packet Data Header 3	
Intra-Packet Data Header 4	
Intra-Packet Data Header 5	

Figure 11-82. Ethernet Data Format 1 Intra-Packet Header

- Intra-Packet Time Stamp. These 8 bytes indicate the time tag of the ARINC-664 message. First long word bits 31-0 and second long word bits 31-0 indicate the following values.
  - The 48-bit RTC that corresponds to the first data bit in the frame with bits 31 to 16 in the second long word zero-filled; or
  - The absolute time, if enabled by bit 6 in the packet flags (Subsection [11.2.1.1](#) item [g](#)). The time format is indicated by bits 2 and 3 in the packet flags (Subsection [11.2.1.1](#) item [g](#)). The time tag shall be correlated to the first data bit in the frame.

- Intra-Packet Data Header. These 20 bytes contain ARINC-664 message data length, virtual link, source and destination IP addresses, and source and destination UDP ports, as shown in [Figure 11-83](#).

msb					lsb
31		16	15	8	7
					0
Data Length		Error bits		Flags bits	
Reserved		Virtual Link			
Source IP					
Dest IP					
Src Port			Dest Port		

Figure 11-83. Intra-Packet Data Header

- Data Length (bits 31-16)  
Message length in bytes
- ERROR Bits (bits 15-8)  
0: No errors  
1: Any undefined error  
2-15: Reserved
- Flags (bits 7-0)  
0: Actual ARINC-664 data  
1: Simulation ARINC-664 data  
2-15: Reserved
- Reserved (bits 31-16)
- Virtual Link (VL) (bits 15-0)  
Lower 16 bits of the Ethernet destination MAC address
- Source IP address (bits 31-0)  
Source IP address from ARINC-664 IP header
- Dest IP Address (bits 31-0)  
Destination IP address from ARINC-664 IP header
- Src Port (bits 31-16)  
16 bits source port from the ARINC-664 UDP header
- Dest Port (bits 15-0)  
Destination port from the ARINC-664 UDP header

#### 11.2.16 Time Space Position Information and Combat Training Systems Data Packets

The time, space, position information (TSPI) and Combat Training Systems (CTS) data type packets are provided to allow a defined method of TSPI/CTS data encapsulation in Chapter 11 packet format. This will provide interoperability of these data sets between ranges and users along with alignment to other digital data in the recording, such as video and audio.

The TSPI/CTS data packets do not require a specific input interface such as PCM, analog, or MIL-STD-1553. The TSPI/CTS data type will only encapsulate multiple types of TSPI/CTS information IAW governing standards and specifications. Essentially, TSPI/CTS data will be wrapped in its native format by Chapter 11 packet structures and reside on compliant media devices and/or within files. The packet definition will not characterize transmission protocols or requirements because those are provided by the governing standards or specifications.

The TSPI/CTS packets are considered dynamic and timing requirements (e.g., of [Chapter 10](#)) apply whether they are generated by the recorder/multiplexer, like computer-generated data packets, or generated via a specific external interface.

11.2.16.1 TSPI/CTS Data Packets, Format 0 (NMEA-RTCM)

Any GPS data as defined by the National Marine Electronics Association (NMEA) and Radio Technical Commission for Maritime Services (RTCM) standards will be encapsulated in the Format 0 packet. The NMEA and RTCM standards specify the electrical signal requirements, data transmission protocol, and message/sentence formats for GPS data. These formatting standards will not be detailed in this chapter, but they will be referenced as required for clarity.

The TSPI/CTS Data Packet, Format 0 (NMEA-RTCM) will not support proprietary messages or sentences; therefore, any data containing these will be considered non-compliant with this standard.

A packet with  $n$  NMEA-RTCM data has the basic structure as [Table 11-52](#).

<b>Table 11-52. NMEA-RTCM Data Packet Format</b>	
msb	lsb
15	0
Packet Header	
Channel-Specific Data (Bits 15-0)	
Channel-Specific Data (Bits 31-16)	
(Optional) Intra-Packet Time Stamp for Data 1 (Bits 15-0)	
(Optional) Intra-Packet Time Stamp for Data 1 (Bits 31-16)	
(Optional) Intra-Packet Time Stamp for Data 1 (Bits 47-32)	
(Optional) Intra-Packet Time Stamp for Data 1 (Bits 63-48)	
Intra-Packet Data Header (Bits 15-0)	
Intra-Packet Data Header (Bits 31-16)	
Byte 2	Byte 1
:	:
Filler (if $n$ is Odd)	Byte N
:	
(Optional) Intra-Packet Time Stamp for Data N (Bits 15-0)	
(Optional) Intra-Packet Time Stamp for Data N (Bits 31-16)	
(Optional) Intra-Packet Time Stamp for Data N (Bits 47-32)	
(Optional) Intra-Packet Time Stamp for Data N (Bits 63-48)	
Intra-Packet Data Header (Bits 15-0)	
Intra-Packet Data Header (Bits 31-16)	

Byte 2	Byte 1
:	:
Filler (if <i>n</i> is Odd)	Byte N
Packet Trailer	

- a. NMEA-RTCM Packet Channel-Specific Data Word. The packet body portion of each NMEA-RTCM data packet begins with a CSDW as shown in [Figure 11-84](#).

msb			lsb
31	30	27	26
0			
IPTS	TYPE	RESERVED	

Figure 11-84. NMEA-RTCM Packet Channel-Specific Data Word

- IPTS. Bit 31 indicates whether the IPTS is enabled.
    - 0 = IPTS not enabled
    - 1 = IPTS enabled
  - TYPE. Bits 30-27 indicate the type of data NMEA-RTCM contains within the packet.
    - 0000 = NMEA 0183
    - 0001 = NMEA 0183-HS
    - 0010 = NMEA 2000
    - 0011 = RTCM SC104
    - 0010 - 1111 = Reserved
  - RESERVED. Bits 26-0 are reserved and shall be zero-filled.
- b. NMEA-RTCM Intra-Packet Time Stamp. If enabled the optional IPTS is inserted before each NMEA-RTCM message. The length of the IPTS is 8 bytes (64 bits) positioned contiguously, in the following sequence ([Figure 11-85](#)).

msb		lsb
31		0
(Optional) Time (LSLW)		
(Optional) Time (MSLW)		

Figure 11-85. NMEA-RTCM Intra-Packet Time Stamp

- Intra-Packet Time Stamp. These 8 bytes indicate the time tag of the NMEA-RTCM data. First long word bits 31-0 and second long word bits 31-0 indicate the following values.
  - The 48-bit RTC that corresponds to the first data bit. Bits 31 to 16 in the second long word (MSLW) will be zero-filled; or
  - The absolute time, if enabled by bit 6 in the packet flags (Subsection [11.2.1.1](#) item [g](#)). The time format is indicated by bits 2 and 3 in the packet flags (Subsection [11.2.1.1](#) item [g](#)). The time tag shall be correlated to the first data bit.

- c. NMEA-RTCM Intra-Packet Data Header. The length of the IPDH is fixed at 4 bytes (32 bits) positioned contiguously, in the following sequence ([Figure 11-86](#)).

msb		lsb
31	16 15	0
RESERVED	LENGTH	

Figure 11-86. NMEA-RTCM Intra-Packet Data Header

- RESERVED. Bits 31-16 are reserved.
- LENGTH. Bits 15-0 indicate the length of the message in bytes.

11.2.16.2 TSPI Data Packets, Format 1 (EAG ACMI)

Air Combat Maneuvering Instrumentation (ACMI) data as defined by the European Air Group (EAG) interface control document (ICD) DF29125<sup>21</sup> for post-mission interoperability will be encapsulated in the Format 1 packet. The EAG ACMI ICD defines the data contents and organization. Electrical signal requirements and data transmission protocol are not defined in DF29125 or in this Chapter 11 format. The data type will be 8-bit ASCII. A packet of EAG ACMI data has the basic structure of [Table 11-53](#).

<b>Table 11-53. EAG ACMI Data Packet Format</b>	
msb	lsb
15	0
Packet Header	
Channel-Specific Data (Bits 15-0)	
Channel-Specific Data (Bits 31-16)	
(Optional) Intra-Packet Time Stamp-Data Block 1 (Bits 15-0)	
(Optional) Intra-Packet Time Stamp-Data Block 1 (Bits 31-16)	
(Optional) Intra-Packet Time Stamp-Data Block 1 (Bits 47-32)	
(Optional) Intra-Packet Time Stamp-Data Block 1 (Bits 63-48)	
Intra-Packet Data Header	
(Optional) Static Data	
Byte 2	Byte 1
:	:
Filler (if <i>n</i> is Odd)	Byte N
Packet Trailer	

- a. EAG ACMI Packet Channel-Specific Data Word. The packet body portion of each EAG ACMI data packet begins with a CSDW as shown in [Figure 11-87](#).

<sup>21</sup> European Air Group. “European Air Group Interface Control Document for Post Mission Interoperability.” DF29125 Draft A Issue 01. July 2004. Retrieved 17 May 2021. Available to RCC members with Private Portal access at <https://www.trmc.osd.mil/wiki/x/vwTYBg>.



msb			lsb		
31	30	29	28	0	
IPTS	CONTENT	RESERVED			

Figure 11-87. EAG ACMI Packet Channel-Specific Data Word

- **IPTS.** Bit 31 indicates whether the IPTS is enabled.
    - 0 = IPTS not enabled
    - 1 = IPTS enabled
  - **CONTENT.** Bits 30-29 indicate the content of the EAG ACMI data within the packet.
    - 00 = TSPI data only (no static data or pod ID)
    - 01 = Contains pod ID and static data
    - 10 - 11 = Reserved
  - **RESERVED.** Bits 28-0 are reserved.
- b. **EAG ACMI Intra-Packet Time Stamp.** If enabled the optional IPTS is inserted before the EAG ACMI data block. The length of the IPTS is 8 bytes (64 bits) positioned contiguously, in the following sequence ([Figure 11-88](#)).

msb			lsb		
31					0
(Optional) Time (LSLW)					
(Optional) Time (MSLW)					

Figure 11-88. EAG ACMI Data Intra-Packet Time Stamp

- **EAG ACMI Intra-Packet Time Stamp.** These 8 bytes indicate the time tag of the EAG ACMI TSPI data. Pod ID and static data will not be time-tagged but will precede the TSPI data in the packet. First long word bits 31-0 and second long word bits 31-0 indicate the following values.
    - The 48-bit RTC that corresponds to the first TSPI data bit. Bits 31 to 16 in the second long word (MSLW) of the IPTS will be zero-filled; or
    - The absolute time, if enabled by bit 6 in the packet flags (Subsection [11.2.1.1](#) item [g](#)). The time format is indicated by bits 2 and 3 in the packet flags (Subsection [11.2.1.1](#) item [g](#)). The time tag shall be correlated to the first data bit.
- c. **EAG ACMI Intra-Packet Data Header.** The length of the IPDH is fixed at 4 bytes (32 bits) positioned contiguously, in the following sequence ([Figure 11-89](#)).

msb			lsb		
31	16 15				0
RESERVED			LENGTH		

Figure 11-89. EAG ACMI Intra-Packet Data Header

- **RESERVED.** Bits 31-16 are reserved.
- **LENGTH.** Bits 15-0 indicate the length of the message in bytes.

## 11.2.16.3 TSPI Data Packets, Format 2 (ACTTS)

Air Combat Test and Training System (ACTTS) data as defined by the USAF ACTTS interface specification WMSP 98-01<sup>22</sup> will be encapsulated in the Format 2 packet. The ACTTS interface specification defines the unique signal interface requirements for the air-to-air, air-to-ground, ground-to-air data links, and aircraft information subsystem recording formats. The ACTTS WMSP 98-01 establishes the requirements for the information recorded on the different data transfer units used by the various ACTTS airborne subsystems to support both tethered and rangeless operations.

When encapsulating ACTTS message/word format, data messages or words will not span packets. Each new packet will start with a full message and not a partial message or word. A packet of ACTTS data has the basic structure of [Table 11-54](#).

<b>Table 11-54. ACTTS Data Packet Format</b>	
msb	lsb
15	0
<b>Packet Header</b>	
Channel-Specific Data (Bits 15-0)	
Channel-Specific Data (Bits 31-16)	
(Optional) Intra-Packet Time Stamp for Data 1 (Bits 15-0)	
(Optional) Intra-Packet Time Stamp for Data 1 (Bits 31-16)	
(Optional) Intra-Packet Time Stamp for Data 1 (Bits 47-32)	
(Optional) Intra-Packet Time Stamp for Data 1 (Bits 63-48)	
<b>Intra-Packet Data Header</b>	
Byte 2	Byte 1
:	:
Filler (if <i>n</i> is Odd)	Byte N
:	:
(Optional) Intra-Packet Time Stamp for Data N (Bits 15-0)	
(Optional) Intra-Packet Time Stamp for Data N (Bits 31-16)	
(Optional) Intra-Packet Time Stamp for Data N (Bits 47-32)	
(Optional) Intra-Packet Time Stamp for Data N (Bits 63-48)	
<b>Intra-Packet Data Header</b>	
Byte 2	Byte 1
:	:
Filler (if <i>n</i> is Odd)	Byte N
<b>Packet Trailer</b>	

- a. ACTTS Packet Channel-Specific Data Word. The packet body portion of each ACTTS data packet begins with a CSDW as shown in [Figure 11-90](#).

<sup>22</sup> Range Instrumentation System Program Office, Air Armament Center. "Interface Specification for the USAF Air Combat Test and Training System (ACTTS) Air-to-Ground, Air-to-Air, Ground-to-Air Data Links, and AIS Recording Formats." WMSP 98-01, Rev A, Chg 1. 19 May 2003. Retrieved 17 May 2021. Available to RCC members with Private Portal access at <https://www.trmc.osd.mil/wiki/x/ygTYBg>.

msb			lsb		
31	30	27	26	0	
IPTS	FORMAT	RESERVED			

Figure 11-90. ACTTS Packet Channel-Specific Data Word

- **IPTS.** Bit 31 indicates whether the IPTS is enabled.
    - 0 = IPTS not enabled
    - 1 = IPTS enabled
  - **FORMAT.** Bits 30-27 indicate the ACTTS format type of data contained within the packet.
    - 0000 = Kadena Interim Training System (KITS) Recording Formats
    - 0001 = Alpena KITS Recording Formats
    - 0010 = USAF Europe Rangeless Interim Training System Recording Formats
    - 0011 = Alaska ACTS Upgrade Recording Formats
    - 0100 = Goldwater Range Mission and Debriefing System Recording Formats
    - 0101 = P4RC Recording Formats
    - 0110 = Nellis ACTS Range Security Initiative Recording Formats
    - 0111 = P4RC+P5 CTS Participant Subsystem Recording Formats
    - 1000 = P5 CTS Recording Formats
    - 1001 - 1111 = Reserved
  - **RESERVED.** Bits 26-0 are reserved.
- b. **ACTTS Intra-Packet Time Stamp.** If enabled the optional IPTS is inserted before each ACTTS message. The length of the IPTS is 8 bytes (64 bits) positioned contiguously, in the following sequence ([Figure 11-91](#)).

msb			lsb		
31					0
(Optional) Time (LSLW)					
(Optional) Time (MSLW)					

Figure 11-91. ACTTS Data Intra-Packet Time Stamp

These 8 bytes indicate the time tag of the ACTTS data. First long word bits 31-0 and second long word bits 31-0 indicate the following values.

- The 48-bit RTC that corresponds to the first ACTTS data bit. Bits 31 to 16 in the second long word (MSLW) of the IPTS will be zero-filled; or
  - The absolute time, if enabled by bit 6 in the packet flags (Subsection [11.2.1.1](#) item [g](#)). The time format is indicated by bits 2 and 3 in the packet flags (Subsection [11.2.1.1](#) item [g](#)). The time tag shall be correlated to the first data bit.
- c. **ACTTS Intra-Packet Data Header.** The length of the IPDH is fixed at 4 bytes (32 bits) positioned contiguously, in the following sequence ([Figure 11-92](#)).

msb		lsb
31	16 15	0
RESERVED	LENGTH	

Figure 11-92. ACTTS Data Intra-Packet Data Header

- **RESERVED.** Bits 31-16 are reserved.
- **LENGTH.** Bits 15-0 indicate the length of the message in bytes.

11.2.17 Controller Area Network Bus Packets

11.2.17.1 Controller Area Network Bus Data Packet, Format 0

Data from one or more controller area network (CAN) bus interfaces are placed into a CAN bus data packet format as shown in [Table 11-55](#).

<b>Table 11-55. Controller Area Network Bus Data Packet, Format 0</b>	
msb	lsb
15	0
Packet Header	
Channel-Specific Data (Bits 15-0)	
Channel-Specific Data (Bits 31-16)	
Intra-Packet Time Stamp for Msg 1 (Bits 15-0)	
Intra-Packet Time Stamp for Msg 1 (Bits 31-16)	
Intra-Packet Time Stamp for Msg 1 (Bits 47-32)	
Intra-Packet Time Stamp for Msg 1 (Bits 63-48)	
Intra-Packet Message Header for Msg 1 (Bits 15-0)	
Intra-Packet Message Header for Msg 1 (Bits 31-16)	
Intra-Packet ID Word for Msg 1 (Bits 47-32)	
Intra-Packet ID Word for Msg 1 (Bits 63-48)	
Msg 1 Byte 2	Msg 1 Byte 1
:	:
Filler (if <i>n</i> is Odd)	Msg 1 Byte <i>n</i>
:	
Intra-Packet Time Stamp for Msg <i>n</i> (Bits 15-0)	
Intra-Packet Time Stamp for Msg <i>n</i> (Bits 31-16)	
Intra-Packet Time Stamp for Msg <i>n</i> (Bits 47-32)	
Intra-Packet Time Stamp for Msg <i>n</i> (Bits 63-48)	
Intra-Packet Message Header for Msg <i>n</i> (Bits 15-0)	
Intra-Packet Message Header for Msg <i>n</i> (Bits 31-16)	
Intra-Packet ID Word for Msg <i>n</i> (Bits 47-32)	
Intra-Packet ID Word for Msg <i>n</i> (Bits 63-48)	
Msg <i>n</i> Byte 2	Msg <i>n</i> Byte 1
:	:
Filler (if <i>m</i> is odd)	Msg <i>n</i> Byte <i>m</i>
Packet Trailer	

- a. CAN Bus Packet Channel-Specific Data Word. The packet body portion of each CAN bus data packet begins with a CSDW. [Figure 11-93](#) displays a complete CAN bus CSDW.

msb								lsb
31			16	15				0
RESERVED				N of Messages				

Figure 11-93. Complete CAN Bus Format 0 Channel-Specific Data Word

- Reserved. Bits 31-16 are reserved.
  - N of Messages. Bits 15-0 contain a binary value indicating the number of messages included in the packet.
- b. CAN Bus Data Intra-Packet Header. After the CSDW, CAN bus data is inserted into the packet. Each CAN bus message is preceded by an IPH that has both an IPTS and an intra-packet message header (IPMH) and an intra-packet ID word. The length of the IPH is fixed at 16 bytes (128 bits) positioned contiguously, in the sequence shown in [Figure 11-94](#).

msb								lsb
31								0
Intra-Packet Time Stamp (LSLW)								
Intra-Packet Time Stamp (MSLW)								
Intra-Packet Message Header								
Intra-Packet ID Word								

Figure 11-94. CAN Bus Data Format 0 Intra-Packet Data Header

- Intra-Packet Time Stamp. These 8 bytes indicate the time tag of the message data. First long word bits 31-0 and second long word bits 31-0 indicate the following values.
  - The RTC that corresponds to the first data bit in the message with bits 31 to 16 in the second long word zero-filled; or
  - Time, if enabled by bit 7 in the packet flags. Time format is indicated by bits 2 and 3 in the packet flags and to the first data bit in the message.
- Intra-Packet Message Header. The IPMH is an information word that is inserted into the packet with the format shown in [Figure 11-95](#).

msb												lsb
31	30	29	24	23		16	15		4	3		0
DE	FE	Reserved	SUBCHANNEL			Reserved	MESSAGE LENGTH					

Figure 11-95. Intra-Packet Message Header

- Data Error (DE). Bit 31 indicates bad data bits as determined by parity, checksums, or CRC words received with the data.
  - 0 = No data error has occurred

1 = Data error has occurred

- Format Error (FE). Bit 30 indicates a protocol error, such as out-of-sequence data or length errors.

0 = No format error

1 = Format error encountered

- Reserved. Bits 29-24 are reserved.
- Subchannel. Bits 23-16 contain a binary value that represents the subchannel number belonging to the message that follows the ID word when the channel ID in the packet header defines a group of subchannels. Zero means first and/or only subchannel, which is valid for the CAN bus.
- Reserved. Bits 15-4 are reserved.
- Message Length. Bits 3-0 contain a binary value representing the length of the number of the valid bytes in the rest of the message that follows the IPMH. The message length will be 4-12 bytes (4 bytes for the intra-packet ID word + 0-8 bytes data content of the CAN bus message).

- Intra-Packet ID Word. The intra-packet ID word contains the CAN bus message ID word transmitted on the bus. This word precedes the message and is inserted into the packet with the format shown in [Figure 11-96](#).

msb				lsb
31	30	29	28	0
IDE	RTR	Res	CAN Bus ID	

Figure 11-96. Intra-Packet ID Word

- IDE (bit 31 of the 32-bit CAN ID word): use extended CAN identifier.
  - 0 = 11-bit standard CAN identifier (CAN ID word bits 10-0)
  - 1 = 29-bit extended CAN identifier (CAN ID word bits 28-0)
- RTR (bit 30 of the CAN ID word): Remote transfer request bit.
- CAN Bus ID: The CAN bus ID transmitted in the message.

When using the 11-bit standard CAN identifier, bits 29-11 of the 32-bit CAN ID word are unused. For the 29-bit extended CAN identifier all the 29 bits, 28-0, are used.

- CAN Bus Message. The CAN bus message is placed behind the CAN bus IPH. The message can consist up to 8 bytes, which is placed in 0-4 x 16-bit data words. [Figure 11-97](#) displays a CAN bus message format.

BYTE 2	BYTE 1
:	:
Filler (if <i>n</i> is Odd)	BYTE <i>n</i>

Figure 11-97. CAN Bus Format 0 Message

11.2.17.2 Controller Area Network Bus Data Packet, Format 1

This section is reserved for future development

11.2.18 Fibre Channel Packets

11.2.18.1 Fibre Channel Data Packets, Format 0 (FC-PH Layer)

Data from a Fibre Channel port can be placed into a Fibre Channel Data Packet Format 0 as shown in [Table 11-56](#).

<b>Table 11-56. Fibre Channel Data Packet, Format 0</b>	
msb	0
15	
PACKET HEADER	
CHANNEL-SPECIFIC DATA (BITS 15-0)	
CHANNEL-SPECIFIC DATA (BITS 31-16)	
INTRA-PACKET HEADER FOR FIBRE CHANNEL FRAME 1 (BITS 15-0)	
INTRA-PACKET HEADER FOR FIBRE CHANNEL FRAME 1 (BITS 31-16)	
INTRA-PACKET HEADER FOR FIBRE CHANNEL FRAME 1 (BITS 47-32)	
INTRA-PACKET HEADER FOR FIBRE CHANNEL FRAME 1 (BITS 63-48)	
INTRA-PACKET HEADER FOR FIBRE CHANNEL FRAME 1 (BITS 79-64)	
INTRA-PACKET HEADER FOR FIBRE CHANNEL FRAME 1 (BITS 95-80)	
FRAME BYTE 2	FRAME BYTE 1
:	:
FILLER (IF $n$ IS ODD)	FRAME BYTE $n$
:	
INTRA-PACKET HEADER FOR FIBRE CHANNEL FRAME $n$ (BITS 15-0)	
INTRA-PACKET HEADER FOR FIBRE CHANNEL FRAME $n$ (BITS 31-16)	
INTRA-PACKET HEADER FOR FIBRE CHANNEL FRAME $n$ (BITS 47-32)	
INTRA-PACKET HEADER FOR FIBRE CHANNEL FRAME $n$ (BITS 63-48)	
INTRA-PACKET HEADER FOR FIBRE CHANNEL FRAME $n$ (BITS 79-64)	
INTRA-PACKET HEADER FOR FIBRE CHANNEL FRAME $n$ (BITS 95-80)	
FRAME BYTE 2	FRAME BYTE 1
:	:
FILLER (IF $n$ IS ODD)	FRAME BYTE $n$
PACKET TRAILER	

- a. Fibre Channel Data Packet Channel-Specific Data Word. The packet body portion of each Fibre Channel data packet begins with a CSDW. It indicates the format and how many Fibre Channel frames are placed in the packet body. The CSDW is formatted for the complete type of packet body as shown in [Figure 11-98](#).

msb						lsb
31	28	27		16	15	0
FORMAT	RESERVED				NUMBER OF FRAMES	

Figure 11-98. Fibre Channel Data Packet Channel-Specific Data Word

- Format. Bits 31-28 indicate the type of Fibre Channel data packet.
    - 0000 = FC-PH physical layer ANSI X3T11 Project 755-D
    - 0001 - 1111 = Reserved
  - Reserved. Bits 27-16 are reserved.
  - Number of Frames. Bits 15-0 contain a binary value that represents the number of complete or stripped Fibre Channel frames included in the packet.
- b. Fibre Channel Data Packet Format 0 Intra-Packet Header. After the channel-specific data, complete or stripped Fibre Channel frames are inserted into the packet. Each complete or stripped Fibre Channel frame is preceded by an IPH that has both an IPTS and an IPDH containing a frame ID word. The length of the IPH is fixed at 12 bytes (96 bits) positioned contiguously, in the following sequence as shown in [Figure 11-99](#).

msb	lsb
31	0
TIME (LSLW)	
TIME (MSLW)	
FRAME ID WORD	

Figure 11-99. Fibre Channel Data Format 0 Intra-Packet Header

- Intra-Packet Time Stamp. These 8 bytes indicate the time tag of the complete or stripped Fibre Channel frame. First long word bits 31-0 and second long word bits 31-0 indicate the following values:
  - The 48-bit RTC that corresponds to the first bit after the CSDW of the complete or stripped Fibre Channel frame with bits 31 to 16 in the second long word zero filled; or
  - The absolute time, if enabled by bit 6 in the packet flags (Subsection [11.2.1.1](#) item [g](#)). The time format is indicated by bits 2 and 3 in the packet flags (Subsection [11.2.1.1](#) item [g](#)). The time tag shall be correlated to the first data bit of the complete or stripped Fibre Channel frame.
- Frame ID Word. The frame ID word is an identification word that precedes the Fibre Channel frame and is inserted into the packet with the format shown in [Figure 11-100](#).

msb													lsb		
31	30	29	28	27	26	25	24	23	19	18	16	15	12	11	0
FE	CE	OE	SM	C	TOP			RSVD	EOF	SOF			FL		

Figure 11-100. Fibre Channel Data Format 0 Intra-Packet Frame ID Word

- Framing Error (FE). Bit 31 indicates a framing error such as EOF missing.
  - 0 = No framing error.
  - 1 = Framing error detected in Fibre Channel frame.
- CRC Error (CE). Bit 30 indicates a CRC error.
  - 0 = No CRC error.



- 1 = CRC error detected in Fibre Channel frame.
- Overrun Error (OE). Bit 29 indicates a buffer overrun error.
  - 0 = No overrun error.
  - 1 = Overrun error detected prior to this Fibre Channel frame.
- Stripped Mode (SM). Bit 28 indicates whether the Fibre Channel frame delimiters, header, and CRC are removed, resulting in a stripped Fibre Channel frame with data payload only.
  - 0 = Stripped mode. Only Fibre Channel data payload is present.
  - 1 = Non-stripped mode. Complete Fibre Channel frame is present.
- Content (CONTENT). Bits 27-26 specify the type of the Fibre Channel frame. Content bits are only valid when in non-stripped mode (i.e., bit 28 = 1).
  - 00 = Complete data frame
  - 01 = Complete link control frame
  - 10-11 = Reserved
- Topology (TOP). Bits 25-24 specify the Fibre Channel topology of frame from the port.
  - 00 = Passive
  - 01 – 11 Reserved
- Reserved. Bits 23-19 are reserved.
- End of Frame (EOF). Bits 18-16 indicate a binary value for the end-of-frame delimiter that terminated the Fibre Channel frame. This is applicable only in stripped mode. Values are as follows:
  - 000 – (0): EOF normal (EOFn)
  - 001 – (1): EOF terminate (EOFt)
  - 010 – (2): EOF disconnect terminate (EOFdt)
  - 011 – (3): EOF abort (EOFa)
  - 100 – (4): EOF normal invalid (EOFni)
  - 101 – (5): EOF disconnect terminate Invalid (EOFdti)
  - 110 – (6): EOF remove terminate (EOFrt)
  - 111 – (7): EOF remove terminate invalid (EOFrti)
- Start of Frame (SOF). Bits 15-12 indicate a binary value for the start-of-frame delimiter that began the Fibre Channel frame. This is applicable only in stripped mode. Values are as follows:
  - 0000 – (0): SOF connect class-1 (SOFc1)
  - 0001 – (1): SOF initiate class-1 (SOFi1)
  - 0010 – (2): SOF normal class-1 (SOFn1)
  - 0011 – (3): SOF initiate class-2 (SOFi2)
  - 0100 – (4): SOF normal class-2 (SOFn2)
  - 0101 – (5): SOF initiate class-3 (SOFi3)
  - 0110 – (6): SOF normal class-3 (SOFn3)
  - 0111 – (7): SOF activate class-4 (SOFc4)

- 1000 – (8): SOF initiate class-4 (SOFi4)
- 1001 – (9): SOF normal class-4 (SOFn4)
- 1010 – (A): SOF fabric (SOFF)
- 1011 – 1111(B-F): Reserved

- Frame Length. In stripped mode, bits 11-0 indicate the length of the frame’s data payload in bytes (excluding the SOF and EOF delimiters and CRC word). In stripped mode, maximum length is 2112 bytes. In non-stripped mode, bits 11-0 indicate the length of the entire Fibre Channel frame in bytes. The frame length must be divisible by 4.

11.2.18.2 Fibre Channel Data Packets, Format 1 (FC-FS Layer)

Data from a Fibre Channel port can be placed into a Fibre Channel Data Packet Format 1. In this format, the Fibre Channel frames placed in the packet include only the frame header and data field. The Start-of-Frame delimiter, End-of-Frame delimiter, and CRC word of the frame are excluded. Fibre Channel Data Packet Format 1 is shown in [Table 11-57](#).

<b>Table 11-57. Fibre Channel Data Packet, Format 1</b>	
msb 15	lsb 0
<b>PACKET HEADER</b>	
CHANNEL-SPECIFIC DATA (BITS 15-0)	
CHANNEL-SPECIFIC DATA (BITS 31-16)	
INTRA-PACKET HEADER FOR FIBRE CHANNEL FRAME 1 (BITS 15-0)	
INTRA-PACKET HEADER FOR FIBRE CHANNEL FRAME 1 (BITS 31-16)	
INTRA-PACKET HEADER FOR FIBRE CHANNEL FRAME 1 (BITS 47-32)	
INTRA-PACKET HEADER FOR FIBRE CHANNEL FRAME 1 (BITS 63-48)	
INTRA-PACKET HEADER FOR FIBRE CHANNEL FRAME 1 (BITS 79-64)	
INTRA-PACKET HEADER FOR FIBRE CHANNEL FRAME 1 (BITS 95-80)	
FRAME BYTE 2	FRAME BYTE 1
:	:
FRAME BYTE n	FRAME BYTE n-1
:	
INTRA-PACKET HEADER FOR FIBRE CHANNEL FRAME n (BITS 15-0)	
INTRA-PACKET HEADER FOR FIBRE CHANNEL FRAME n (BITS 31-16)	
INTRA-PACKET HEADER FOR FIBRE CHANNEL FRAME n (BITS 47-32)	
INTRA-PACKET HEADER FOR FIBRE CHANNEL FRAME n (BITS 63-48)	
INTRA-PACKET HEADER FOR FIBRE CHANNEL FRAME n (BITS 79-64)	
INTRA-PACKET HEADER FOR FIBRE CHANNEL FRAME n (BITS 95-80)	
FRAME BYTE 2	FRAME BYTE 1
:	:
FRAME BYTE n	FRAME BYTE n-1
<b>PACKET TRAILER</b>	

- a. Fibre Channel Data Packet Channel-Specific Data Word. The packet body portion of each Fibre Channel Data Packet begins with a CSDW. It indicates how many Fibre

Channel frames are placed in the packet body. The CSDW is formatted for the complete type of packet body as shown in [Figure 11-101](#).

msb		lsb
31	16 15	0
RESERVED		NUMBER OF FRAMES

Figure 11-101. Fibre Channel Data Packet Channel-Specific Data Word Format

- Reserved. Bits 31-16 are reserved.
  - Number of Frames. Bits 15-0 contain a binary value that represents the number of Fibre Channel frames included in the packet.
- b. Fibre Channel Data Packet Format 1 Intra-Packet Header. After the channel-specific data, Fibre Channel frames are inserted into the packet. Each Fibre Channel frame is preceded by an IPH that has both an IPTS and an IPDH containing a frame status word. The length of the IPH is fixed at 12 bytes (96 bits) positioned contiguously, in the following sequence as shown in [Figure 11-102](#).

msb	lsb
31	0
TIME (LSLW)	
TIME (MSLW)	
FRAME STATUS WORD	

Figure 11-102. Fibre Channel Data Format 1 Intra-Packet Header

- Intra-Packet Time Stamp. These 8 bytes indicate the time tag of the Fibre Channel frame. The timestamp is sampled and latched at the end of the last bit of the Start-of-Frame delimiter. First long word bits 31-0 and second long word bits 31-0 indicate the following values:
  - The 48-bit RTC that corresponds to the first bit after the CSDW of the Fibre Channel frame with bits 31 to 16 in the second long word zero filled; or
  - The absolute time, if enabled by bit 6 in the packet flags (Subsection [11.2.1.1](#) item [g](#)). Time format is indicated by bits 2 and 3 in the packet flags (Subsection [11.2.1.1](#) item [g](#)).
- Frame Status Word. The frame status word precedes the Fibre Channel frame and is inserted into the packet with the format shown in [Figure 11-103](#).

msb												lsb
31	30	29	28	19	18	16	15	12	11	0		
FE	CE	OE	RESERVED	EOF	SOF	FRAME LENGTH						

Figure 11-103. Fibre Channel Data Format 1, (FC-FS Layer) Intra-Packet Frame Status Word

- Framing Error (FE). Bit 31 is used to indicate a framing error, such as EOF missing.

- 0 = No framing error.
- 1 = Framing error detected in Fibre Channel frame.
- CRC Error (CE). Bit 30 indicates a CRC error was detected.
  - 0 = No CRC error.
  - 1 = CRC error detected in Fibre Channel frame.
- Overrun Error (OE). Bit 29 is used to indicate a buffer overrun error.
  - 0 = No overrun error.
  - 1 = Overrun error detected prior to this Fibre Channel frame.
- Reserved. Bits 28-19 are reserved.
- End of Frame (EOF). Bits 18-16 indicate a binary value for the End-Of-Frame delimiter that terminated the Fibre Channel frame. Values are as follows:
  - 000 – (0): EOF normal (EOFn)
  - 001 – (1): EOF terminate (EOFt)
  - 010 – (2): EOF disconnect terminate (EOFdt)
  - 011 – (3): EOF abort (EOFa)
  - 100 – (4): EOF normal invalid (EOFni)
  - 101 – (5): EOF disconnect terminate invalid (EOFdti)
  - 110 – (6): EOF remove terminate (EOFrt)
  - 111 – (7): EOF remove terminate invalid (EOFrti)
- Start of Frame (SOF). Bits 15-12 indicate a binary value for the Start-Of-Frame delimiter that began the Fibre Channel frame. Values are as follows:
  - 0000 – (0): SOF connect class-1 (SOFc1)
  - 0001 – (1): SOF initiate class-1 (SOFi1)
  - 0010 – (2): SOF normal class-1 (SOFn1)
  - 0011 – (3): SOF initiate class-2 (SOFi2)
  - 0100 – (4): SOF normal class-2 (SOFn2)
  - 0101 – (5): SOF initiate class-3 (SOFi3)
  - 0110 – (6): SOF normal class-3 (SOFn3)
  - 0111 – (7): SOF activate class-4 (SOFc4)
  - 1000 – (8): SOF initiate class-4 (SOFi4)
  - 1001 – (9): SOF normal class-4 (SOFn4)
  - 1010 – (A): SOF fabric (SOFF)
  - 1011 – 1111(B-F): Reserved
- Frame Length. Bits 11-0 indicate the combined length of the Fibre Channel frame header and data fields (excludes the SOF, EOF delimiters, and CRC word of the frame) in bytes. This field must be evenly divisible by 4.

## APPENDIX 11-A

### Definitions

The following are definitions that are used in this standard and are provided as a means of removing ambiguities within the standard.

**Absolute Time:** A hypothetical time that either runs at the same rate for all the observers in the universe or the rate of time each observer can be scaled to by multiplying the observer's rate by a constant.

**Byte:** A contiguous set of 8 bits that are acted on as a unit.

**Channel-Specific Data Word:** A required word for each data type channel that has data-specific information.

**Data Streaming:** Streaming of current value data whether it is being recorded or not, and playback streaming of recorded data from a file. Data streaming sends the data to one or more destinations simultaneously (e.g., recording media, recorder data interfaces).

**Extended Relative Time Counter:** A 1-GHz extension to the existing 10-MHz RTC.

**Long Word:** A contiguous set of 32 bits that are acted on as a unit.

**Mandatory:** Defines a mandatory requirement of this standard for full compliancy. Mandatory requirements as defined in this standard are based on the use of "shall".

**Multiplexer:** The entity that includes all the inputs, control interfaces, and functionality required to properly record data.

**Packet:** Encapsulates a block of observational and ancillary application data to be recorded.

**Packet Generation:** The placing of observational and ancillary data into a packet.

**Recorder:** Is used where a function or requirement shall apply to both an on-board recorder and a ground-based recorder.

**Recording:** Is defined as the time interval from first packet generated to the last packet committed to the recorder media. Packet generation time and stream commit time, as defined within the standard, apply.

**Session:** Period of time during which data is acquired, processed and/or stored. Typically corresponds to a recording (q.v.)

**Setup Record:** TMATS IAW [Chapter 9](#) annotated in the Computer-Generated Data, Format 0 packet.

**Stream:** All packets from all enabled channels (including computer-generated data) that are generated.

**Stream Commit Time:** The time span in which all generated packets must be committed to a stream.

**Word:** A contiguous set of 16 bits acted on as a unit.

This page intentionally left blank.

## APPENDIX 11-B

### Citations

- Automated Imaging Association. *GiGE Vision*. Version 1.2. n.d. Retrieved 17 May 2021. Available for download with registration at <https://www.automate.org/a3-content/vision-standards-all-standards-forms>.
- Department of Defense. "Aircraft Internal Time Division Command/Response Multiplex Data Bus." MIL-STD-1553B. 21 September 1978. Superseded by update 28 February 2018. Retrieved 17 May 2021. Available at [https://quicksearch.dla.mil/qsDocDetails.aspx?ident\\_number=36973](https://quicksearch.dla.mil/qsDocDetails.aspx?ident_number=36973).
- . "National Imagery Transmission Format Version 2.1." MIL-STD-2500C w/Change 2. 2 January 2019. May be superseded by update. Retrieved 17 May 2021. Available at [https://quicksearch.dla.mil/qsDocDetails.aspx?ident\\_number=112606](https://quicksearch.dla.mil/qsDocDetails.aspx?ident_number=112606).
- European Air Group. "European Air Group Interface Control Document for Post Mission Interoperability." DF29125 Draft A Issue 01. July 2004. Retrieved 17 May 2021. Available to RCC members with Private Portal access at <https://www.trmc.osd.mil/wiki/x/vwTYBg>.
- European Machine Vision Association. *GenICam Standard Features Naming Convention*. Version 1.5. November 2011. Retrieved 17 May 2021. Available at [http://www.emva.org/wp-content/uploads/GenICam\\_SFNC\\_1\\_5.pdf](http://www.emva.org/wp-content/uploads/GenICam_SFNC_1_5.pdf).
- Institute of Electrical and Electronics Engineers. *IEEE Standard for a Precision Clock Synchronization Protocol for Networked Measurement and Control Systems*. IEEE 1588-2008. Geneva: International Electrotechnical Commission, 2008.
- . *IEEE Standard for a High-Performance Serial Bus*. IEEE 1394-2008. New York: Institute of Electrical and Electronics Engineers, 2008.
- . *IEEE Standard for a High Performance Serial Bus: Amendment 2*. IEEE 1394b-2002. New York: Institute of Electrical and Electronics Engineers, 2002.
- . *IEEE Standard for a High Performance Serial Bus*. IEEE 1394-1995. New York: Institute of Electrical and Electronics Engineers, 1995.
- . *IEEE Standard for Ethernet*. IEEE 802.3-2012. New York: Institute of Electrical and Electronics Engineers.
- . *Information technology – Generic coding of moving pictures and associated audio information: Part 1: Systems – Technical Corrigendum 1*. ISO/IEC 13818-1:2019/COR 1:2020. October 2020. May be superseded by update. Retrieved 10 May 2021. Available for purchase at <https://www.iso.org/standard/75928.html>.

- . *Information Technology -- JPEG 2000 Image Coding System: Core Coding System*. ISO/IEC 15444-1:2016. October 2016. Revised by ISO/IEC 15444:1-2019. Retrieved 17 May 2021. Revised version available for purchase at <https://www.iso.org/standard/78321.html>.
- . *Information technology: JPEG 2000 image coding system: motion JPEG 2000*. ISO/IEC 15444-3:2007. Geneva: International Organization for Standardization, 2007.
- International Telecommunications Union Telecommunication Standardization Sector. *Information technology: Generic coding of moving pictures and associated audio information: Systems*. ITU-T REC.H.222.0. 29 August 2018. May be superseded by update. Retrieved 10 May 2021. Available for purchase from <https://www.itu.int/rec/T-REC-H.222.0-201808-I>.
- Internet Engineering Task Force. “Network Time Protocol (Version 3) Specification, Implementation and Analysis.” RFC 1305. March 1992. Obsoleted by RFC 5905. Retrieved 17 May 2021. Available at <https://datatracker.ietf.org/doc/rfc1305/>.
- Lockheed Martin Corporation. “Advanced Weapons Multiplex Data Bus.” 8 June 2010. May be superseded by update. Retrieved 17 May 2021. Available to RCC members with Private Portal access at <https://www.trmc.osd.mil/wiki/x/xwTYBg>.
- Motion Imagery Standards Board. *Audio Encoding*. ST 1001.1. 27 February 2014. May be superseded by update. Retrieved 10 May 2021. Available at <https://www.gwg.nga.mil/misb/docs/standards/ST1001.1.pdf>.
- . *Motion Imagery Standards Profile*. MISP-2020.1. October 2019. May be superseded by update. Retrieved 13 July 2021. Available at <https://gwg.nga.mil/misb/docs/misp/MISP-2020.1.pdf>.
- . *MPEG-2 Transport of Compressed Motion Imagery and Metadata*. ST 1402.2. 27 February 2014. May be superseded by update. Retrieved 10 May 2021. Available at <https://gwg.nga.mil/misb/docs/standards/ST1402.pdf>.
- Range Commanders Council. *IRIG Serial Time Code Formats*. RCC 200-16. August 2016. May be superseded by update. Retrieved 17 May 2021. Available at <https://www.trmc.osd.mil/wiki/x/wou8Bg>.
- Range Instrumentation System Program Office, Air Armament Center. “Interface Specification for the USAF Air Combat Test and Training System (ACTTS) Air-to-Ground, Air-to-Air, Ground-to-Air Data Links, and AIS Recording Formats.” WMSP 98-01, Rev A, Chg 1. 19 May 2003. Retrieved 17 May 2021. Available to RCC members with Private Portal access at <https://www.trmc.osd.mil/wiki/x/ygTYBg>.

\*\*\*\* END OF CHAPTER 11 \*\*\*\*



## CHAPTER 21

### Telemetry Network Standard Introduction

<b>Acronyms</b> .....	<b>21-iii</b>
<b>Chapter 21. Telemetry Network Standard Introduction</b> .....	<b>21-1</b>
<b>21.1 Introduction</b> .....	<b>21-1</b>
<b>21.2 Telemetry Network Standard Overview</b> .....	<b>21-2</b>
21.2.1 TmNS System Concepts .....	21-3
21.2.2 TmNS Core Technologies.....	21-5
21.2.3 TmNS Definitions.....	21-9
<b>21.3 Relationship Between Standards and Specifications</b> .....	<b>21-15</b>
<b>Appendix 21-A. Clarifications and Conventions</b> .....	<b>A-1</b>
<b>A.1. Standards Key Words</b> .....	<b>A-1</b>
<b>A.2. Document Conventions</b> .....	<b>A-1</b>
A.2.a. Usage of Defined Terms .....	A-1
A.2.b. Usage of Message Fields .....	A-1
A.2.c. Scope of References.....	A-2
A.2.d. Usage of Note Boxes .....	A-2
<b>A.3. SNMP Conventions</b> .....	<b>A-2</b>
<b>A.4. XML Concepts and Style Guide</b> .....	<b>A-3</b>
A.4.a. Standards Language .....	A-3
A.4.b. General MDL Requirements.....	A-3
A.4.c. XML Schema Concepts .....	A-4
A.4.d. Syntax Conventions of MDL Element Descriptions .....	A-5
A.4.e. Conditional Element in the MDL Schema Definition File .....	A-5
A.4.f. Naming Conventions in the MDL Schema Definition File .....	A-5
A.4.g. Indexing Policies.....	A-5
A.4.h. Use of Supplemental XML-Based Standards .....	A-5
A.4.i. Uniqueness of ID Attributes .....	A-6
A.4.j. Description of ReadOnly Element .....	A-6
A.4.k. Description of Owner Element .....	A-6
<b>Appendix 21-B. Bit Numbering and Byte Ordering</b> .....	<b>B-1</b>
<b>B.1. Bit Field Syntax</b> .....	<b>B-1</b>
<b>B.2. Bit Numbering Convention</b> .....	<b>B-1</b>
<b>B.3. Octet (Byte) Ordering</b> .....	<b>B-2</b>
<b>Appendix 21-C. Citations</b> .....	<b>C-1</b>

## List of Figures

Figure 21-1.	Generalized TmNS System Diagram Showing Different Control Planes .....	21-4
Figure 21-2.	IETF Hourglass .....	21-5
Figure 21-3.	TmNS-Specific IETF Hourglass.....	21-5
Figure 21-4.	System Management Technologies .....	21-6
Figure 21-5.	Core TmNS Technologies and TmNS-Specific Protocols in the TCP/IP Model Context .....	21-9

## Acronyms

DAU	data acquisition unit
FTP	File Transfer Protocol
HTTP	Hypertext Transfer Protocol
IETF	Internet Engineering Task Force
iNET	integrated Network Enhanced Telemetry
IP	Internet Protocol
lsb	least significant bit
LTC	Latency/Throughput Critical
MDL	Metadata Description Language
MIB	management information base
msb	most significant bit
OSI	Open Systems Interconnection
PCM	pulse code modulation
QoS	Quality of Service
RC	Reliability Critical
RF	radio frequency
RFC	Request for Comment
SNMP	Simple Network Management Protocol
TA	test article
TCP	Transmission Control Protocol
TmNS	Telemetry Network Standard
UDP	User Datagram Protocol
XML	eXtensible Markup Language

This page intentionally left blank.

## CHAPTER 21

### Telemetry Network Standard Introduction

#### 21.1 Introduction

The Telemetry Network Standard (TmNS) crosses IRIG 106, chapters 21 through 28. This chapter introduces fundamental concepts and terminology used in the subsequent chapters. Additionally, this chapter provides guidance as to which of the remaining chapters might be of most interest for a particular reader. In order to guide the reader toward the chapters of further interest, the applicable chapters are referenced throughout this chapter as it introduces concepts and terminology. A quick synopsis of chapters 22 through 28 is provided below.

- IRIG 106 [Chapter 22](#): Network-Based Protocol Suite  
The TmNS approach leverages existing standardized Internet protocols to serve as the core set of communication protocols. The TmNS's network-based protocol suite and a large portion of the Transmission Control Protocol (TCP)/Internet Protocol (IP) Protocol Suite (also known as the Internet Protocol Suite) along with other supporting technologies (e.g., underlying data link and physical layer technologies) are described in this chapter.
- IRIG 106 [Chapter 23](#): Metadata Configuration  
This chapter describes system configuration data for TmNS-based systems. It allows them to be described in a common fashion, and it provides the means for describing the configuration of the components in a telemetry system, as well as their logical and physical interrelationships. This chapter defines a language, the Metadata Description Language (MDL), which has a syntax that defines vocabulary and sentence structure, while the MDL semantics provide meaning. The MDL provides a common exchange language that facilitates the interchange of configuration information between telemetry system components.
- IRIG 106 [Chapter 24](#): Message Formats  
The TmNS has defined several message structures unique for its use. This chapter describes the message formats of TmNS-specific messages.
- IRIG 106 [Chapter 25](#): Management Resources  
The TmNS defines Management Resources as resources that contain application-specific data accessible via an application layer protocol. Each TmNS application defines a set of common resources and a set of application-specific resources. This chapter provides details concerning the standardized application resources.
- IRIG 106 [Chapter 26](#): TmNSDataMessage Transfer Protocol  
The TmNS has defined several data transfer protocols unique for its use. This chapter defines how TmNS-specific messages (TmNSDataMessages) are transferred between TmNSApps.
- IRIG 106 [Chapter 27](#): Radio Frequency (RF) Network Access Layer  
This chapter defines the standard for managing the physical layer of RF links with the RF network. The network implements an Open Systems Interconnection (OSI) model approach to data transmission, where data moves through the OSI stack from the

application layer to the physical layer, from physical layer to physical layer through some transmission medium, then back up the stack to another application on the receiving side.

- IRIG 106 [Chapter 28](#): RF Network Management  
This chapter defines the mechanisms and processes for managing RF links within the RF network.

## 21.2 Telemetry Network Standard Overview

At its core the TmNS describes networks and interfaces for components on the networks. All TmNS-based networks strive to be similar to existing Internet-based networks. Additionally, the TmNS provides mechanisms for melding with pre-existing devices, approaches, and technologies.

A fundamental principle of the TmNS approach is to enhance, rather than replace, today's telemetry systems by providing significant improvements in spectrum efficiency in order to revolutionize how flight tests are executed. This enhancement principle in turn drives the need for the new TmNS-based capabilities to be melded with pre-existing devices, approaches, and technologies. As such, the existing pulse code modulation (PCM) telemetry systems are augmented with TmNS features provided through TmNS components.

The IP network foundation of the TmNS brings with it features including routing, Quality of Service (QoS), and congestion control. The following list highlights some of the capabilities that IP networking brings to telemetry.

- Addition of Bidirectional Communications to Telemetry: bidirectional communications is one of the most fundamental enhancements provided by the TmNS. It enables the following capabilities.
  - Real-Time Access to Test Article (TA) Measurements: Provides a mechanism for real-time access to current and past measurements on the TA both directly from the sensors and from the recorder(s).
  - PCM Backfill: Provides the ability to retrieve measurements from the TAs in near real time that were dropped in the Serial Streaming Telemetry feed (PCM dropouts).
  - Real-Time Command and Control of TA Equipment: Provides the ability to status, configure, and control TA equipment from the ground station.
- Dynamic Spectrum Sharing: Provides the ability to share spectrum resources among many concurrent test activities based on instantaneous demand for telemetry resources.
- Quality of Service: Provides the ability to dynamically share spectrum resources based on priorities of certain activities over others and also to prioritize the delivery of certain measurements over others (e.g., voice).
- Fully Interconnected System: Provides the ability to seamlessly transition transmission and receipt of data from TAs from one antenna to another, including antennas in different networks (frequencies) and in other ranges. The TmNS uses the term "handoff" to describe this type of transition.

- **Over-the-Horizon Telemetry:** Provides the ability to perform TA-to-TA telemetry (relay) communications to support tests involving large numbers of TAs and long distances.

### 21.2.1 TmNS System Concepts

The TmNS defines interfaces, data delivery protocols, configuration files, and command and control concepts. These are standardized so as to support interoperability across components (and vendors) within a particular TmNS-defined network.

#### 21.2.1.1 TmNS Interfaces

The TmNS is composed of sets of components that are modeled after network appliances typically found on the Internet. In fact, some TmNS system components (e.g., routers and switches) are almost exact functional matches to network appliances that are used on the Internet. Each TmNS-compliant component implements certain TmNS interfaces (as applicable), thus providing multi-vendor interoperability. These TmNS interfaces are as follows.

- **Management Interface:** Used for configuring, obtaining status, controlling, and reporting. The MDL is the main interface used for configuring TmNS-compliant devices. Further details concerning this topic are found in [Chapter 23](#) and [Chapter 25](#).
- **Time Interface:** Used for distribution and acquisition of time through the network. Further details concerning this topic are found in [Chapter 22](#).
- **Data (Measurements) Delivery Interface:** Used to move acquired test data from TAs to ground processing based on different delivery requirements. Further details concerning this topic are found in [Chapter 23](#), [Chapter 24](#), and [Chapter 26](#).
- **RF Network Interface:** Defines mechanisms for low-level control and status of the two-way telemetry communications and overall spectrum sharing. Further details concerning this topic are found in [Chapter 27](#) and [Chapter 28](#).

<p><b>NOTE</b></p> 	<p>Not all components are required to support all interfaces. For example, a data acquisition unit (DAU) would typically implement the management, time, and data interfaces listed above. This architecture choice was made to minimize the complexity of any one item and to aid the possibility of creating a broad array of configurations.</p>
--	---

#### 21.2.1.2 Data Delivery

The TmNS defines two data delivery mechanisms.

- **Latency/Throughput Critical Delivery Protocol:** used to deliver test data when latency or throughput constraints are more important than reliability constraints (real-time). The underlying technologies supporting this delivery protocol are User Datagram Protocol, Internet Group Management Protocol, and IP multicasting.
- **Reliability Critical Delivery Protocol:** used to deliver test data when reliability constraints are more important than latency or throughput constraints (reliable). The underlying technologies supporting this delivery protocol are TCP and Real Time Streaming Protocol. Further details concerning this topic are found in [Chapter 26](#).

**NOTE**  Data delivery concepts support variations for latency, throughput, and reliability. For instance, during one phase of a particular test, the test operators may need samples of a particular set of measurements with as little latency as possible due to safety of flight issues, even if it means losing some samples during telemetry dropouts. In another phase of the same test, the test operators may need a reliable transport of these same measurements for analysis even if it raises latency due to resending data lost during telemetry dropouts.

### 21.2.1.3 Command and Control Planes

The TmNS defines two primary command and control planes.

- **Test/Mission Command and Control Plane (Red Network):** This plane is focused on command and control associated with a particular test. It is concerned with measurements, telemetry processing, message/data formats, data recording, and TA component configuration and status. This plane resides in the red-side (plain-text) portions of a TmNS system, which are mainly comprised of the red network components on the TA(s) and Mission Control Room, as shown in [Figure 21-1](#). Red Network components are behind a Type-1 inline network encryptor.

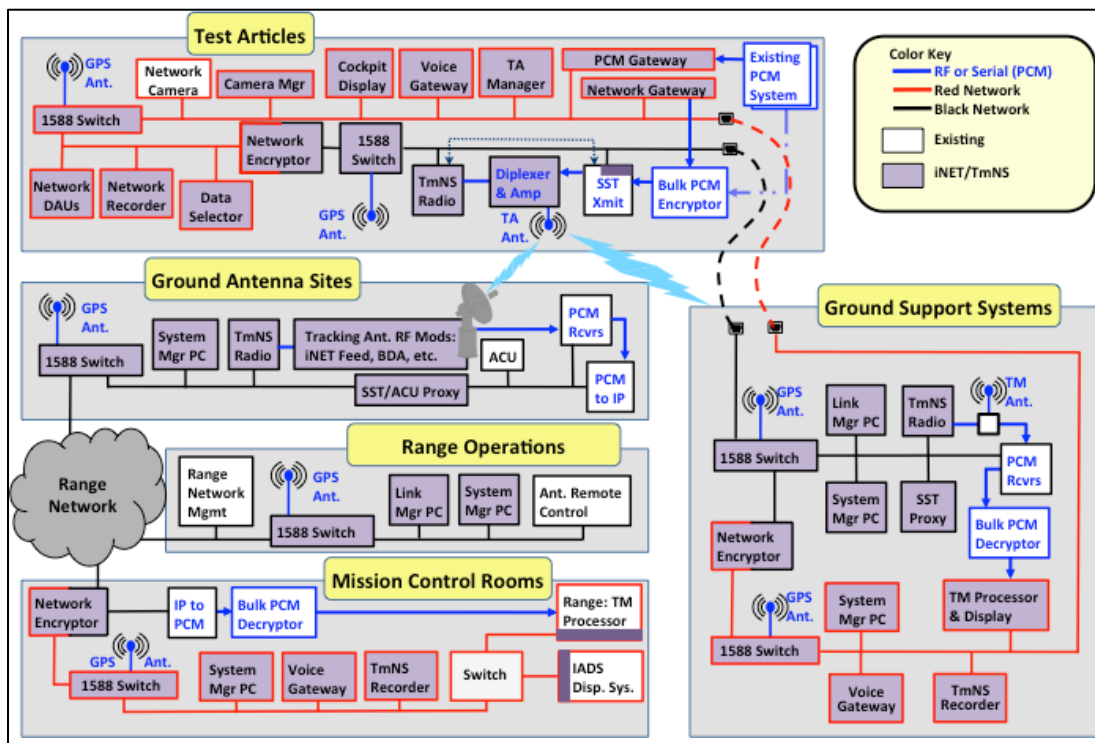



Figure 21-1. Generalized TmNS System Diagram Showing Different Control Planes

- **Range Infrastructure Command and Control Plane (Black Network):** This plane is focused on command and control associated with the provisioning of resources needed for a given test or set of tests within a range or across multiple ranges. It is concerned with spectrum sharing, QoS, establishment and management of two-way



telemetry communications, and the transitioning of communications from TAs from a given ground antenna site to another (antenna-to-antenna handoff). This plane resides in the black-side (cypher-text) portions of a TmNS system, which are mainly comprised of the ground antenna sites, range operations center, and black network components on the TA(s), as shown in [Figure 21-1](#). Further details concerning this topic are found in [Chapter 25](#) and [Chapter 28](#).

 <p><b>NOTE</b></p>	<p>By separating the control into two planes, areas of concern may be separate across range personnel.</p>
--	--

### 21.2.2 TmNS Core Technologies

The TmNS utilizes an IP network that is based on the success and description of the Internet Engineering Task Force (IETF) hourglass approach, as shown in [Figure 21-2](#). The IP layer is the basic interoperability between networked components. [Figure 21-3](#) shows a TmNS specialization of the classic IETF IP hourglass figure.

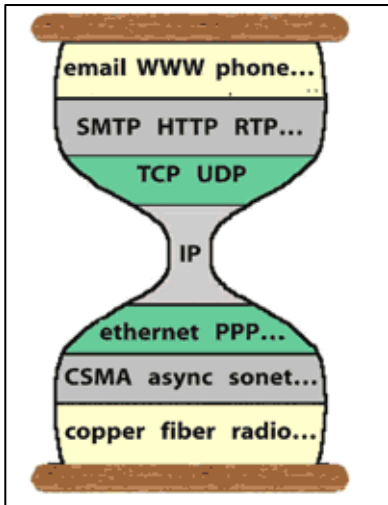

Figure 21-2. IETF Hourglass

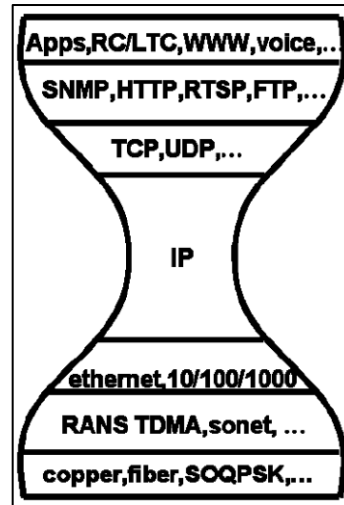

Figure 21-3. TmNS-Specific IETF Hourglass

Further details concerning this topic are found in [Chapter 22](#).

#### 21.2.2.1 Network-Based Data Messages

Test data is delivered in TmNSDataMessages, which contain a header and a payload. Actual measurements are contained in the packages within a TmNSDataMessage, and the mapping of measurements in a TmNSDataMessage is defined in a system configuration file, which is an MDL file that describes the configuration for a particular device that is transmitting or consuming a given TmNSDataMessage. Further details concerning this topic are found in [Chapter 23](#) and [Chapter 24](#).

### 21.2.2.2 System Configuration and Management

System management within the TmNS is based upon the International Organization for Standardization Telecommunications Management Network model FCAPS, which stands for fault, configuration, accounting, performance, and security.

System management is used across a TmNS system to manage TmNS-compliant components, providing a view of fault, configuration, accounting, performance, and security configuration information on the network. Essentially, a TmNS system is composed of two types of components when it comes to management and configuration:

1. Managed devices: Any TmNS-compliant component that provides a management interface as defined by [Chapter 25](#);
2. TmNS Managers: An entity that manages TmNS-compliant components. Managers implement the interfaces necessary to manage TmNS-compliant components in accordance with [Chapter 25](#). Further details concerning this topic are found in [Chapter 25](#).

[Figure 21-4](#) shows the building blocks of system management as specified by the TmNS. The core technologies used are Simple Network Management Protocol (SNMP) to pass management information through the system. The SNMP management information bases (MIBs) provide dictionaries for management information. Managed devices execute applications called agents that use the TmNS-defined MIB to provide their internal status and to accept controls and configuration. File Transfer Protocol (FTP), Hypertext Transfer Protocol (HTTP), and Internet Control Message Protocol (ping) play supporting roles related to file transfer, discovery, and configuration.

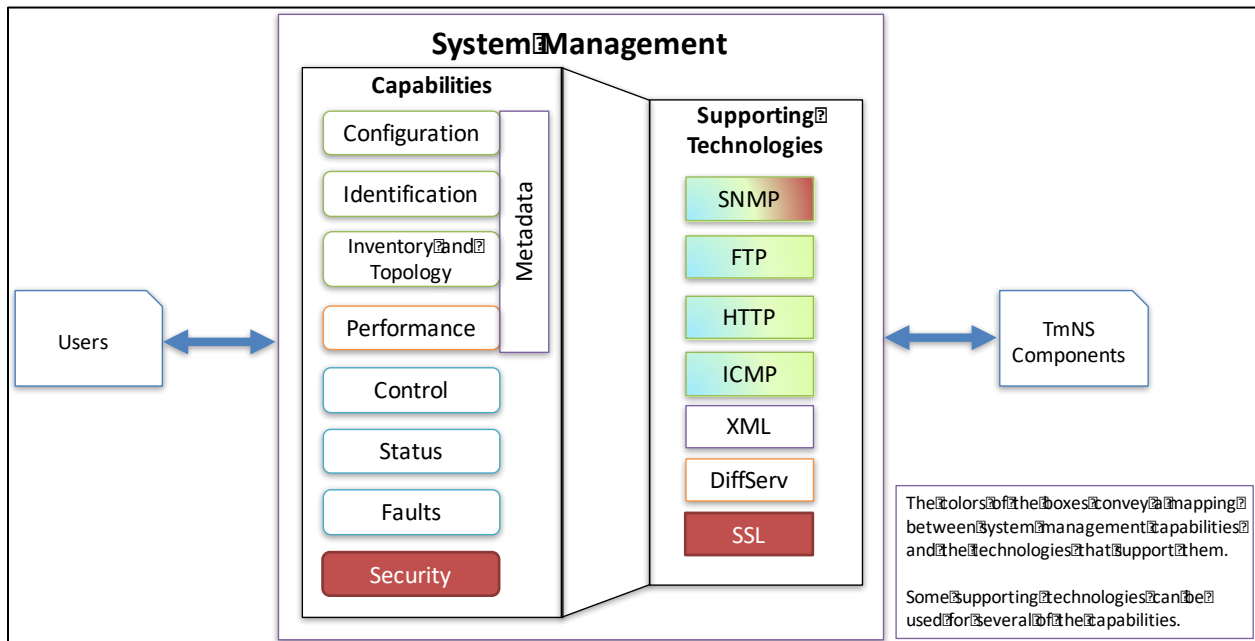

Figure 21-4. System Management Technologies

Further details concerning this topic are found in [Chapter 22](#).

The MDL is used for describing system configuration (Metadata) in a common fashion. The eXtensible Markup Language (XML) schema defined by the TmNS provides the means for describing the configuration of the components in a TmNS system as well as their logical and physical interrelationships. The MDL is expressive enough to describe a wide variety of systems: large and small, simple and complex, from the low-level transducer-to-measurement association for an acquisition card on a DAU up to network topology of multiple test mission networks.

A table containing a mapping of MDL elements to relevant paragraphs of the TmNS (IRIG 106 Chapters 21-28) is contained in [Chapter 23](#) Appendix 23-B. This table can be used by a reader of the standard to identify the MDL elements that correspond to particular paragraphs or to identify the paragraphs that correspond to particular MDL elements.

Further details concerning this topic are found in [Chapter 23](#).

By using the system management capabilities, TmNS-compliant components can be configured, reconfigured, controlled, and stasured in an interoperable way.

<p><b>NOTE</b></p> 	<p>A typical way to utilize the system management capabilities is to provide a system manager. This kind of user application provides monitoring, controlling, configuring, coordinating, and visualizing the operations of a system built based on the TmNS. System manager users are typically able to obtain system and device-level status, including status of TA instrumentation and information about local and system-wide network performance (expected versus actual). Additionally, the display of a system manager typically provides an indication of system health and details of any fault conditions detected within the TmNS system.</p>
--	---

### 21.2.2.3 Time

Time within an entire TmNS-based system is distributed using IEEE 1588-2008<sup>1</sup>, also known as Precision Time Protocol Version 2. Time within a TmNS system is delivered without the addition of any wires.

Further details concerning this topic are found in [Chapter 22](#).

<p><b>NOTE</b></p> 	<p>All TmNS-compliant network switches can be synchronized to an external time source (e.g., Global Positioning System) and act as 1588 master clocks for a local network within the TmNS network (e.g., red TA network, black TA network, etc.).</p> <p>Components requiring sub-microsecond precision, such as DAUs for time stamping measurements, are able to do so using a hardware implementation of 1588.</p>
--	--

<sup>1</sup> Institute of Electrical and Electronics Engineers. *IEEE Standard for a Precision Clock Synchronization Protocol for Networked Measurement and Control Systems*. IEEE 1588-2008. Geneva: International Electrotechnical Commission, 2008.

#### 21.2.2.4 Quality of Service

The TmNS annotates a typical Differentiated Services architecture, which is a standard IP QoS mechanism for coordination of the delivery of competing data and command and control network traffic.

Further details concerning this topic are found in [Chapter 22](#) and [Chapter 23](#).

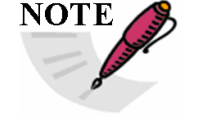
 <p><b>NOTE</b></p>	<p>The QoS mechanism can be used to for certain sets of data within a particular test (or across multiple tests) that might have stringent delivery requirements due to performance reasons (e.g., voice data), safety of flight concerns, etc.</p>
--	---

#### 21.2.2.5 Routing

Routing is the process of selecting best paths in a network. The TmNS annotates IETF standards concerning a typical routed IP network. Using the classic routed IP architecture enables a variety of advanced capabilities, including relay, and other capabilities that have not yet been explored.

Further details concerning this topic are found in [Chapter 22](#) and [Chapter 23](#).

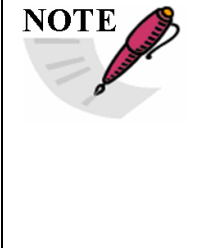
 <p><b>NOTE</b></p>	<p>Just as in large-scale networks (e.g., the Internet) the components within a TmNS-based network are not aware about the network path that is used to deliver data from one node to another. All a given component needs to know is its next hop. This means that components that transport data within the TmNS system need to support these classic routing concepts, including TmNS-compliant radios, which are network routers themselves. As such, radios in general can route data to any other radio within reach at any time.</p>
---	---

#### 21.2.2.6 Source Selection

When RF propagation from one TmNS-compliant transmitting radio source arrives at two or more TmNS-compliant receiving radios, it is possible using routing and source selection to choose any one of the network packets. This support is provided through TmNS interfaces, data message formats, and management concepts. Collectively, these concepts are called TmNS Source Selector.

Further details concerning this topic are found in [Chapter 28](#).

#### 21.2.2.7 Security

The TmNS is architected with a variety of security mechanisms in order to meet a particular program's needs. The TmNS security mechanisms are segmented into mechanisms that secure the data transfer from the TAs to the ground (i.e., from one secure enclave to another), as well as for securing other types of communications where the information is not classified, but can be sensitive from an operational perspective.

Communications between secure enclaves (e.g., TAs and mission control) are protected via National Security Agency-approved type-1 security mechanisms that mitigate the anticipated threats. The RF communications are protected via FIPS-140-2 mechanisms.

Additional security mechanisms used to protect data within a TmNS system include:

- Secure Sockets Layer (SSL): used as a security mechanism for transferring data over HTTP and FTP.
- SNMP v3: needed for secure SNMP communications within a TmNS system. It supports both authentication and privacy.

Further details concerning this topic are found in [Chapter 22](#).

### 21.2.2.8 Layered Architecture and Summary of Core Technologies

The TmNS architecture is, by design, a communications and data delivery system that is partitioned into abstraction layers. As in the OSI model, a layer serves the layer above it and is served by the layer below it. The layers are in general independent, so that a layer can be changed with little to no impact to the other layers. This layered architecture in turn allows different technologies to be used in each layer.

[Figure 21-2](#) and [Figure 21-3](#) show the IETF hourglass approach and the corresponding specialization of that hourglass. [Figure 21-5](#) depicts the technologies discussed in this section and how they relate to each other and work cohesively across the different TCP/IP model layers. Further details concerning this topic are found in [Chapter 22](#).

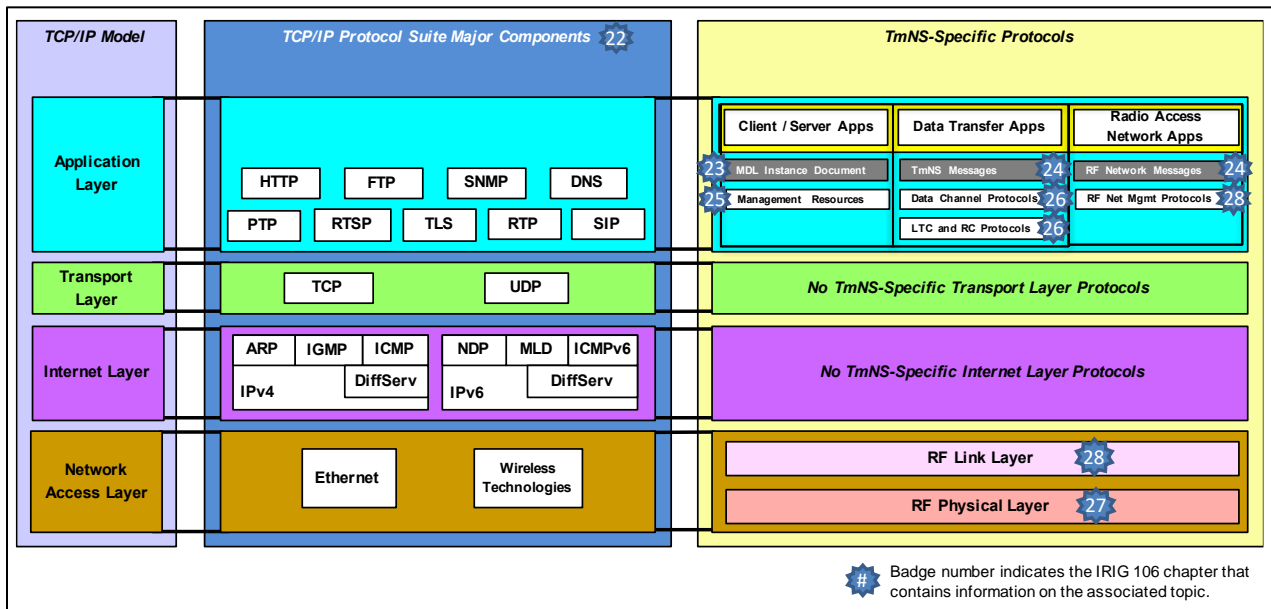

Figure 21-5. Core TmNS Technologies and TmNS-Specific Protocols in the TCP/IP Model Context

### 21.2.3 TmNS Definitions

The TmNS utilizes a collection of terms that have specific meanings when used in a TmNS context. They are typically highlighted in *italics*. A list of the overarching definitions appears in this section.

**AES Cryptographic Algorithm:** This Advanced Encryption Standard (AES) block cipher encryption algorithm, described in detail in FIPS PUB 197<sup>2</sup>, is recommended by the National Security Agency in order to provide an adequate protection mechanism for the communication link.

**Agent:** A Simple Network Management Protocol (SNMP) process that provides SNMP-based *ManagementResources* on a *NetworkNode* or *NetworkDevice*.

**Attached Synchronization Marker (ASM):** A specific bit pattern preceding each low-density parity-check *codeblock* group to aid *codeblock frame* synchronization.

**Bit Error Rate:** The ratio of the number of bits incorrectly received to the total number of bits sent during a specific time interval.

**Black (or Blackside):** A portion of a network that is not physically protected (not secure) with respect to another portion of the network. Sensitive data that traverses this network must be protected by encryption.

**Burst:** The time interval of RF emission, from start to end in a time-division multiplex media access scheme.

**Burst Preamble:** A specific bit pattern transmitted at the beginning of a *burst* to facilitate carrier frequency symbol timing acquisition.

**Burst Sequence:** The *burst* information field structure.

**Burst Synchronization:** Involves the acquisition and tracking of the signal carrier(s), the symbols/bits, the frames, or *codeblocks* from a recovered clock at the receiver.

**Carrier Frequency Error:** Uplink and downlink frequency error bounds established for single-carrier *SOQPSK-TG waveform*.

**Codeblock:** The minimum quanta of a fixed LDPC codeword block that consists of 4,096 information bits or 6144 coded bits with 2/3 LDPC code rate.

**Codeblock Frame:** A variable PHY frame unit that consists of a minimum of one LDPC *codeblock* and up to maximum of eight LDPC *codeblocks*. It is preceded by an *attached synchronization marker* (ASM).

**DataDeliveryControlChannel:** The common elements of the communication mechanisms for the setup, tear-down, and operation of the *RC* and *LTC Delivery Protocols*. See [Chapter 26](#).

**DataChannel:** Identifies a network connection used to transport *TmNSDataMessages* between a *DataSource* and a *DataSink*.

**DataSink:** A *TmNSApp* that consumes *TmNSDataMessages* that contain *MeasurementData*. Identified as the data-consuming portion of a *ResourceClient* or *ResourceServer*.

**DataSource:** A *TmNSApp* that produces *TmNSDataMessages* that contain *MeasurementData*. Identified as the data-producing portion of a *ResourceClient* or *ResourceServer*.

---

<sup>2</sup> National Institute of Standards and Technology. "Specification for the Advanced Encryption Standard (AES)." FIPS PUB 197. 26 November 2001. May be superseded by update. Retrieved 17 May 2021. Available at <http://nvlpubs.nist.gov/nistpubs/FIPS/NIST.FIPS.197.pdf>.

**DiffServ (Differentiated Services):** A computer networking architecture that specifies a simple, scalable and coarse-grained mechanism for classifying, managing, and providing *Quality of Service* (QoS) guarantees on IP network traffic.

**Downlink Transmission:** Communication originating at a *Test Article* and terminating at the *Ground*. With reference to a *Relay*, communication originating at a *Test Article* and terminating at the *Relay*.

**Dynamic Allocation:** A method of scheduling TDMA time slots for transmissions by radios based on a set of criteria, such as bandwidth needs and mission priorities.

**Enclave:** A distinct portion of a network, system, or facility that is isolated, usually for security-related purposes, from the rest of the network, system, or facility.

**Encryption & Decryption:** NIST FIPS 140-2 certified bulk cryptographic module along with *AES cryptographic algorithm* is recommended by the National Security Agency for communication link security at link layer.

**Epoch:** A TDMA frame unit that allocates *transmission opportunity* (TxOp) resources for uplink and downlink. Epoch is equivalent to a *TDMA frame*.

**Forward Error Correction:** A system of error control for data transmission, whereby sender adds redundant data to its messages, which is known as error correction code. This allows receiver to detect and correct errors (within some bound) without the need to ask the sender for additional data.

**Ground Network:** One or more *TmNS Networks* that interconnect *Ground-based NetworkNodes*.

**Ground Station (GS):** A ground infrastructure that, at a minimum, consists of primary and remote antenna sites, serial streaming telemetry (SST) and *ground network* infrastructures. Nominally *Ground Radios* are located in a *Ground Station*.

**Ground Station Network:** A *TmNS Network* that interconnects connected *NetworkNodes* physically residing in a *Ground Station*.

**Handoff:** The process of transferring communications from one source radio to another source radio for the same destination RF MAC Address. The original source radio may be referred to as the “Leave Radio” while the new source radio may be referred to as the “Join Radio”.

**HDLF Frame:** A protocol based on ISO-13239 Standard that was modified to support frame boundary delineations, to carry link layer control messages and user datagrams.

**Information Data:** The channel information data, prior to channel coding, that includes user data and channel overhead affiliated with OSI layer-1 and layer-2. Overhead affiliated with OSI layer-3 through layer-7 is included as user data.

**Integrated Services (IntServ):** A computer network architecture that specifies fine-grained, reservation-based mechanisms for providing *Quality of Service* (QoS) guarantees for individual IP network traffic flows.

**Latency/Throughput Critical (LTC) Delivery Protocol:** The *TmNS*-specific application-level method of delivering *TmNSDataMessages* via User Datagram Protocol (UDP).

**Link Agent:** Executes link control operations in a *Radio*.

**Link Manager (LM):** A *TmNSApp* responsible for optimized control and coordination of *Radio* operations across multiple *Radios* in the RF Network. The primary role of RF Link Management is implementation of the TDMA controller that allocates transmission opportunities for its managed *Radio* components.

**Low-Density Parity-Check (LDPC) Code** – A variant of *Forward Error Correction* codes that uses block codes for error correction. Code is specified by parity check matrix *H* and utilizes generator matrix *G* to perform encoding.

**LTCControlChannel:** The communication mechanism for the setup, tear-down, and operation of the *LTC Delivery Protocol*. See [Chapter 26](#).

**LTCDataChannel:** The communication mechanism for delivery of *TmNSDataMessages* using the *LTC Delivery Protocol*. See [Chapter 26](#).

**LTCDataSink:** A *DataSink* that utilizes the *LTC Delivery Protocol*.

**LTCDataSource:** A *DataSource* that utilizes the *LTC Delivery Protocol*.

**Management Information Base (MIB):** A “Structure of Management Information” (SMI) formatted text file used by the SNMP *Agents* and *Managers* to define a common communication language for exchanging management information.

**ManagementResource:** An application-accessible entity that is used for command, control, and health and status monitoring. *ManagementResources* may be generic to the host platform or may be specific to the TmNS-based environment.

**ManagementURI:** The Uniform Resource Identifier (URI) that describes a particular *ManagementResource*.

**Manager:** A Simple Network Management Protocol (SNMP) process that accesses SNMP-based *ManagementResources* on a *NetworkNode*.

**MeasurementData:** A digital representation of a measurement.

**MeasurementID (MeasID):** A numerical identifier that refers to a specific *MeasurementData* described in an MDL instance document.

**MessageDefinitionID (MDID):** A numerical identifier that refers to a specific *Message* Definition described in an MDL instance document.

**Metadata:** Information that describes a system and data interrelationships; defined in the Telemetry Network Standard.

**Metadata Description Language (MDL) Instance Document:** A document that complies with the language defined in [Chapter 23](#).

**NetworkDevice:** A *NetworkNode* that provides network and/or data link layer service and interconnectivity, without modifying data above the network layer. See Open Systems Interconnection (OSI) model.

**NetworkInterface:** A module that implements an interface, both logical and physical, between a *NetworkNode* and a *TmNS Network*.



**NetworkNode:** Any device that contains a *NetworkInterface* that is connected to a *TmNS Network*. Nominally runs one or more *TmNSApps*.

**Notification:** An asynchronous SNMP message generated by a *TMA*.

**Occupied Bandwidth (OBW):** The bandwidth containing 99% of the total integrated power of the transmitted spectrum, centered on the assigned channel frequency. The width of a frequency band such that, below the lower and above the upper frequency limits, the mean powers emitted are each equal to a specified percentage B/2 of the total mean power of a given emission. In this standard, B/2 is taken as 0.5%.

**Octet:** A sequence of eight bits.

**Package:** A data container composed of *MeasurementData*.

**PackageDefinitionID (PDID):** A numerical identifier that refers to a specific *Package Definition* described in an MDL instance document.

**Physical Layer (PHY):** The first and lowest layer in the seven-layer OSI model. This layer defines the means of transmitting raw bits rather than logical data packets over a physical link connecting Radio and network nodes. This layer translates logical communications requests from the data link layer into hardware-specific operations to effect transmission or reception of electronic signals.

**Quality of Service:** An umbrella term describing the delivery and performance requirements of a data transfer and/or the network mechanisms used to meet those requirements.

**Queue Management:** An RF Network-defined common, standardized interface to the *Traffic Engineering Queues*, which may be implemented with non-standard, vendor-specific mechanisms.

**Radio:** Consists of a *Link Agent*, RF transceiver, and Ethernet transceiver.

**Radio Air Channel Data Rate:** Raw channel data rate that includes user data, aggregated overheads (physical and layer-2), and coding overhead.

**Radio Air Data Rate:** Data rate from the output of the radio modulator. Specified as:

- Radio air user data rate, prior to aggregated overheads (physical and layer-2) and coding.
- Radio air information data rate that includes aggregated overheads but prior to coding.
- Radio air channel data rate that includes aggregated overheads and coding

**Radio Bearer:** The service provided by the RF Network to transfer data between the test article network and ground station network. Service is the collection of all means and facilities provided by the network to allow a certain type of communication over the network.

**RCControlChannel:** The communication mechanism for the setup, tear-down, and operation of the *RC Delivery Protocol*. See [Chapter 26](#).

**RCDataChannel:** The communication mechanism for delivery of *TmNSDataMessages* using the *RC Delivery Protocol*. See [Chapter 26](#).

**RCDataSink:** A *DataSink* that utilizes the *RC Delivery Protocol*.

**RCDataSource:** A *DataSource* that utilizes the *RC Delivery Protocol*.

**Red (or Redside):** A portion of a network that is physically protected (secure) with respect to another portion of the network. Sensitive data may be communicated within this protected enclave without need for encryption.

**Relay:** Hierarchical TDMA node structure that allows *Test Article* to act as a relay node to extend communication link ranges by facilitating nearby *Test Articles* to join the network and by linking communications between *TDMA controllers*.

**Reliability Critical (RC) Delivery Protocol:** The TmNS-specific application-level method of delivering *TmNSDataMessages* via Transmission Control Protocol (TCP).

**ResourceChannel:** Identifies a network connection used to transport *ResourceRequests* and *ResourceResponses* between a *ResourceClient* and a *ResourceServer*.

**ResourceClient:** A *TmNSApp* that generates *ResourceRequests* and may incorporate the *DataSource* and/or *DataSink* functionality.

**ResourceInterface:** A software interface used by *TMA*s to access *ManagementResources*. The standard currently supports an SNMP-based interface and an HTTP-based interface for accessing different *ManagementResources*.

**ResourceRequest:** Request to access a specific *ManagementResource* and is generated by a *ResourceClient*.

**ResourceResponse:** Returns information in response to a *ResourceRequest* regarding a specific *ManagementResource* and is generated by a *ResourceServer*.

**ResourceServer:** A *TMA* that receives and processes *ResourceRequests*, generates *ResourceResponses*, and may incorporate the *DataSource* and/or *DataSink* functionality.

**RF Network:** The segment of a *TmNS Network* that provides network connectivity over RF interfaces between *Test Article Networks* and *Ground Station Networks*.

**RF Network Message (RFNM):** A network-independent structure that contains control or status information regarding RF Network conditions.

**RoleID:** A string that refers to the role of a *TMA*.

**SOQPSK-TG Waveform:** An RCC-TG-defined variant of MIL-STD-188/181A ternary continuous phase modulated single-carrier waveform established to achieve spectrum efficiency and robustness.

**Spectral Mask:** Requirement for RF emission spectrum containment for single-carrier *SOQPSK-TG waveform*.

**Telemetry Network Standard (TmNS):** Another name for IRIG 106 Chapters 21-28.

**Test Article:** A vehicle infrastructure that, at a minimum, consists of on-board antenna, Serial Streaming Telemetry (SST), and test article network infrastructures.

**Test Article Network:** A *TmNS Network* that interconnects connected *NetworkNodes* physically residing on a test article.

**Time Division Multiple Access (TDMA):** A Time-Division Duplex scheme (TDD) to separate uplink and downlink transmission signals. TDMA emulates full-duplex communication over a half-duplex link.

**TmNSApplication (TmNSApp):** an application running on a *NetworkNode* that provides or utilizes one or more TmNS interfaces.

**TmNSManageableApplication (TMA):** A TmNSApp that provides other applications with access to a set of *ManagementResources* via one or more *ResourceInterfaces*.

**TmNSAppManager:** An application that monitors the status or controls one or more *TMA*s.

**TmNSDataMessage:** An MDID-based *TmNSMessage* that contains a *TmNSDataMessageHeader* and a *TmNSDataMessagePayload*; described in [Chapter 24](#).

**TmNSDataMessageHeader:** Fields in a *TmNSDataMessage* that precede a *TmNSDataMessagePayload*.

**TmNSDataMessagePayload:** Composed of zero or more *Packages*.

**TmNSMessage:** A network-independent structure composed of a *TmNSMessageHeader* and a *TmNSMessagePayload*; described in [Chapter 24](#).

**TmNStimestamp:** A TmNS-specific time format for encoding timestamps in a human-readable textual representation (yyymmddThhmmss.ssssssss).

**TmNS Network:** A network that conforms to the IRIG 106 Chapter 21-28 Telemetry Network Standard.

**TmNS Source Selector (TSS):** Tunnel management functionality

**TmNS\_Request\_Defined\_URI:** The uniform resource identifier (URI) that describes the request specification as defined by the *LTC* and *RC Delivery Protocols*.

**Traffic Engineering Queues (TE Queues):** A set of functionality provided by the RF Network that collectively includes the implementation and control of queue structures and associated mechanisms used to provide optimized *Quality of Service* performance.

**Transmission Opportunity (TxOp):** Transmission time slots assigned by a *TDMA controller* to each *Test Article Radio* for downlink transmission of data and control information and to the *Ground Station Radio* for uplink transmission of data and control information.

**TSS Client:** An application that implements one or more TSS Interfaces and issues tunnel connection commands to a TSS Server.

**TSS Server:** An application that implements a TSS Interface and listens for incoming tunnel connection commands from TSS Clients.

**Type Length Value (TLV):** A flexible format for defining or specifying data fields in a message, especially when the fields may be of variable length and multiple fields are encapsulated into the message. Used as the data structure that forms RFNMs.

**Uplink Transmission:** Communication originating at the *Ground* and terminating at a *Test Article*. With reference to a *Relay*, communication originating at the *Relay* and terminating at a *Test Article*.

**User Data:** Referred to as test data, mission data, or data plane data.

### 21.3 Relationship Between Standards and Specifications

As part of the integrated Network Enhanced Telemetry (iNET) program, the TmNS and specifications were developed to guide the development of the system and the interoperability between the components. The goal of the TmNS is to promote an open system architecture and interoperability across component vendors by defining functional system interfaces. The intent of the specifications is to define the system, hardware, software, testing, and performance requirements associated with the TmNS Demonstration System and each of the components within the TmNS Demonstration System. As such, the requirements contained in each component specification largely reference back to the TmNS. It is important to note that the specifications were developed in preparation for the TmNS Demonstration System and, while they are suited for other systems implementing the TmNS, a range may decide to tailor these specifications to meet their specific needs.

## APPENDIX 21-A

### Clarifications and Conventions

#### A.1. Standards Key Words

In many sections of Chapters 21-28, key words are used to signify the requirements in the standard. This section defines these words (derived from Request for Comment [RFC] 2119<sup>3</sup>) as they should be interpreted in iNET standards. Note that the force of these words is modified by the requirement level of the standard in which they are used.

- **SHALL**: This word means that the definition is an absolute requirement of the standard.
- **SHALL NOT**: This phrase means that the definition is an absolute prohibition of the standard.
- **SHOULD**: This word means that there may exist valid reasons in particular circumstances to ignore a particular item, but the full implications must be understood and carefully weighed before choosing a different course.
- **SHOULD NOT**: This phrase means that there may exist valid reasons in particular circumstances when the particular behavior is acceptable or even useful, but the full implications should be understood and the case carefully weighed before implementing any behavior described with this label.
- **MAY**: This word means that an item is truly optional. One implementation may choose to include the item because a particular marketplace requires it or because the implementation enhances the product while another implementation may omit the same item. An implementation that does not include a particular option **SHALL** be prepared to interoperate with another implementation that does include the option, though perhaps with reduced functionality. In the same vein, an implementation that does include a particular option **SHALL** be prepared to interoperate with another implementation that does not include the option (except, of course, for the feature the option provides).

#### A.2. Document Conventions

##### A.2.a. Usage of Defined Terms

The words defined in Subsection [21.2.3](#) are reserved for specific use and will be italicized when they appear throughout the TmNS chapters. The use of italics is reserved exclusively for words that appear in Subsection [21.2.3](#).

##### A.2.b. Usage of Message Fields

Names of specific fields within the *TmNSDataMessage* structure are indicated by an Arial font. Some field names are the same as terms defined in Subsection [21.2.3](#). When a statement refers to a field, the field name will adhere to this convention. It will not be italicized.

---

<sup>3</sup> Internet Engineering Task Force. "Key Words for Use in RFCs to Indicate Requirement Level." RFC 2119. March 1997. Updated by RFC 8174. Retrieved 17 May 2021. Available at <https://datatracker.ietf.org/doc/rfc2119/>.

### A.2.c. Scope of References

A reference to a section number from any of the TmNS chapters includes only that specific section and not its subsections. A reference to a section number followed by an asterisk indicates that the section referenced and all of its subsections are included in the context of the reference.

### A.2.d. Usage of Note Boxes

Throughout the TmNS chapters, note boxes such as the one below will appear with information relevant to the material being presented in the surrounding text. These note boxes will act as a supplement to guide the reader with rationale and advisories where they are deemed useful; however, the content of the note boxes is purely informational. Either by their presence and/or removal, the note boxes shall not augment the rules and specifications presented in the TmNS in any way.

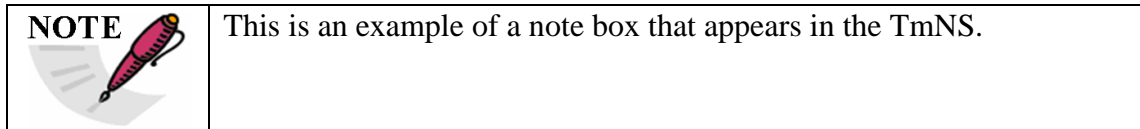

## A.3. **SNMP Conventions**

This document uses a set of conventions when defining SNMP variables.

- For each variable, a “Type” and a “Read-Write” value is indicated. These values are defined by the SNMP RFCs and are only restated here for clarity.
  - Type (of SNMP variables) – NOTIFICATION-TYPE, IPAddress, Counter64, Counter32, Integer32, Unsigned32, and TimeTicks are defined by SNMPv2-SMI (RFC 2578<sup>4</sup>). TestAndIncr, TruthValue, and DisplayString are defined by SNMPv2-TC (RFC 2579<sup>5</sup>). INTEGER is an enumerated form of Integer32.
  - Read-Write (of SNMP variable) – read-only, read-write, read-create, not-accessible, and accessible-for-notify are SNMP variable access levels (RFC 2578). The first two types are self-explanatory. The term “read-create” indicates a table entry may be read, created, or modified. The term “not-accessible” means the variable is used internally by the SNMP *Agent* (such as a table index), but is not retrievable through SNMP network commands. The term “accessible-for-notify” means the variable is used as part of an SNMP notification and is not retrievable through SNMP network commands.
- To define the structure of the SNMP *MIB* tree, the following convention is used:
  - [Bracketed Description] – Description entries in variable tables surrounded with square brackets indicate the variable’s placement in the *TmNS MIB*. For example: [tmnsTmaCommonIdentification 2] indicates that the variable is the second variable on the tmnsTmaCommonIdentification branch.
- Conventions used in place of table values include:

<sup>4</sup> Internet Engineering Task Force. “Structure of Management Information Version 2 (SMIV2).” April 1999. May be superseded or amended by update. Retrieved 17 May 2021. Available at <https://datatracker.ietf.org/doc/rfc2578/>.

<sup>5</sup> Internet Engineering Task Force. “Textual Conventions for SMIV2.” RFC 2579. April 1999. May be superseded or amended by update. Retrieved 17 May 2021. Available at <https://datatracker.ietf.org/doc/rfc2579/>.

- Blank String (“”) – A blank or empty string is indicated as double-quotes with no characters. This is commonly used to initialize a string before a value is assigned.
- N/A – Not Applicable. For example, this value is given for the default state of tables indicating that the table has no rows, and so has no default values. N/A is also given for read-only variables that are expected to hold constant properties of the device (such as the *TmNSManageableApplication* type).

## A.4. XML Concepts and Style Guide

### A.4.a. Standards Language

The Metadata Standard defines a language. When compared to the other standards, the *Metadata* concept is closest to the MIB in the System Management standard. Both define a standard vocabulary for exchanging information. The MIB variables are somewhat like individual attributes and elements in a schema. A full language differs from a vocabulary in that in addition to identifying words and meanings, it also defines how the words can be composed together to form more-complex sentences. These concepts together are syntax, which identifies the words and valid sentence structures for a language. The semantics of a language are not merely related to the structure of the sentences, but also construct the meanings of the sentences in the context of the way the language will be used.

The Metadata Standard defines a language; the syntax identifies vocabulary and sentence structure, and the semantics provide meaning. The constraints in the Metadata Standard are distributed between statements that are syntax-related (encoded and enforced by the schema) and statements that are semantic-related (additional rules that are levied and provide meaning). The syntax of the language will be enforced using XML Schema constraints. When possible, XML mechanisms are used to enforce semantic constraints. In cases not supported cleanly by XML, text has been added directly to this standard. In such cases, the text will typically include the keyword “shall”. The phrase “the value of the `Name` element of the `Measurement` element shall be unique” is one such example.

*Metadata* instances (i.e., sentences) in general describe a telemetry system. The descriptions may be used in various ways: to configure *NetworkNodes*; to predict the performance of the network; or to capture requirements for the telemetry system.

### A.4.b. General MDL Requirements

The MDL is an XML-based language for describing network-based telemetry systems. It can be used to capture requirements, design decisions, and configuration information. The MDL can also facilitate the interchange of information between tools.

This section provides context for how to interpret the language described herein, and suggests how it can be used. This includes:

- The drivers of the MDL design;
- The standards upon which it is built;
- How to extend and constrain the language.

#### A.4.c. XML Schema Concepts

The MDL defines a syntax, which includes a vocabulary, a set of types, and the rules for how an MDL instance document shall be structured. The syntax definition is realized using the XML Schema standard, which is maintained by the World Wide Web Consortium. This section explains the basic concepts of XML Schema that are utilized by the MDL. A more-detailed explanation of the fundamentals of the XML Schema standard is outside the scope of this document, but an explanation can be found in Section 2.2.2<sup>6</sup> of the W3C reference.

An XML Schema defines the rules of an XML-based language with six main constructs: elements, attributes, complex types, simple types, a root element, and constraints.

The XML Schema elements, of type `xsd:element`, represent information containers in an XML instance document. An element defines an XML tag that appears as “<xsd:element>” in an instance document. This specification defines where an element of the indicated type can be created in the instance document.

The XML Schema attributes, of type `xsd:attribute`, represent information that describe the element to which they are attached. The MDL has very few attributes defined because they are reserved for XML-specific uses. For example, they are used when the XML instance document needs to have information about the ordering of an element.

The XML Schema complex types, of type `xsd:complexType`, define structures that specify what an element can contain. Complex types are analogous to classes in an object-oriented language. An element defined as a complex type can contain other elements as well as attributes. They can define the combinations and ordering of the contained elements.

The XML Schema simple types, of type `xsd:simpleType`, define restrictions or specializations of basic types used within the schema definition. For instance, a simple type could be defined to restrict the value of an integer, of type `xsd:integer`, to an inclusive range of integer values from 0 to 255. These constructs are used mainly for validation and type restriction.

An XML Schema requires an instance document to have a top-level element called a root element. The root element contains all other elements and attributes in an instance document.

The XML Schema constraint mechanism defines a syntax (or grammar) of an XML language. Constraints enforce language rules against an XML instance document. For example, constraints can verify that referential integrity is maintained.

The XML Schema constraints can also be used to enforce semantic constraints in a very limited way. For example, constraints can be used to require an element to appear only if another element is defined; however, the XML Schema language does not have the ability to fully define the semantic context that is necessary to understand the full meaning of a language. An efficient and accepted approach for describing the semantics or meanings of a language has yet to be developed.

---

<sup>6</sup> World Wide Web Consortium. “Declaration Components” in *XML Schema Part 1: Structures Second Edition*. 28 October 2004. May be superseded by update. Retrieved 17 May 2021. Available at [http://www.w3.org/TR/xmlschema-1/#Declarations\\_Summary](http://www.w3.org/TR/xmlschema-1/#Declarations_Summary).



#### A.4.d. Syntax Conventions of MDL Element Descriptions

Non-literal symbols (the ones that are not in “”) represent MDL elements or attributes. Each of these is linked to a section in this document.

By convention, this standard includes the built-in XML Schema types, which are identified with the namespace prefix “xsd”. For example, the Name element in the example above is of the type `xsd:string`. The supported simple types in the MDL are those defined in the XML Schema standard. Simple data types (i.e., `xsd:simpleType(s)`) defined by the MDL generally appear with the namespace prefix “mdl”.

#### A.4.e. Conditional Element in the MDL Schema Definition File

The MDL schema is a system-level description. Not all components require every element to properly configure. In such cases, these elements are conditional. The documentation specifies when the conditional elements shall be present and processed. Components not specifically called out in documentation of conditional elements shall not fail to configure if the particular conditional element is not present.

#### A.4.f. Naming Conventions in the MDL Schema Definition File

The Metadata Standard details the elements and attributes that form the MDL schema. In the MDL schema definition file, these MDL elements and attributes appear as instances of defined `xsd:complexType` and `xsd:simpleType` elements. Each declaration of these MDL-specific elements will specify a `name` attribute that is assigned a string that contains the name of the MDL element being described followed by a string suffix of “Type” or “Enum”. For example, the top-level element of the MDL schema is the `MDLRoot` element. In the MDL schema definition file, this element appears as an instance of an `xsd:complexType` element with a `name` attribute of “MDLRootType”. These `name` attribute strings that correspond to the defined MDL elements do not appear in this document; they only appear in the MDL schema definition file.

#### A.4.g. Indexing Policies

Numerical indices present in an MDL instance document are recommended to count starting at 1 and to increment by one (i.e., 1, 2, 3, 4,...).

#### A.4.h. Use of Supplemental XML-Based Standards

The use of other XML-based standards (i.e., other schemas) in conjunction with the MDL schema is permitted. Potentially, the use of these external standards through their accompanying schemas leverages existing knowledge to describe concepts and domains beyond those in the MDL. The MDL does not explicitly constrain the available mechanisms to use external standards; however, the linking of external schemas to the MDL schema shall not result in the modification of the MDL schema.

Refer to [Chapter 23](#) Appendix 23-A for example approaches and mechanisms for linking other XML-based schemas to the MDL schema.

A.4.i. Uniqueness of ID Attributes

Values of ID attributes of any element in an MDL instance document shall be unique. The ID attributes are used to implement references.

A.4.j. Description of ReadOnly Element

All elements of type `xsd:complexType` in the MDL schema contain an optional `ReadOnly` element, which, of type `xsd:boolean`, indicates whether or not its containing element and all its subelements can be modified. A value of “true” indicates that these elements cannot be modified. Conversely, a value of “false” indicates that these elements can be modified. The default value of the `ReadOnly` element is “false”.

A.4.k. Description of Owner Element

All elements of type `xsd:complexType` in the MDL schema contain an optional `Owner` element, which can occur, at most, once in its containing element. The `Owner` element, of type `xsd:string`, is an identifier for the owner or administrator of the containing element in an MDL instance document. The rights and access controls associated with the identified owner will determine the ability of MDL instance document editors to modify the containing element and all its subelements.

 <p><b>NOTE</b></p>	<p>It is expected that a standardized set of values for the <code>Owner</code> element will be established. Until these values are determined, the Metadata Standard does not constrain the value of the <code>Owner</code> element.</p>
---	--

## APPENDIX 21-B

### Bit Numbering and Byte Ordering

#### B.1. Bit Field Syntax

Numeric values specified in bit fields shall be represented using the following syntax:

```
size ' radix value
```

where

size	The number of binary bits that comprise the number.
'	A single quote separator.
radix	Radix of the number. Valid radix are: b = binary h = hexadecimal d = decimal
value	Bit field value represented as a numeric string.

Examples:

```
3'b101
32'h12345678
20'h1C      (20'h0001C)
11'd123     (11'b00001111011)
```

 <b>NOTE</b>	This bit field syntax is a subset of the Verilog Hardware Description Language syntax for representing numbers.
---	---

#### B.2. Bit Numbering Convention

Whenever an octet field represents a numeric quantity, the left-most bit in the field is the most significant bit (msb) and the right-most bit in the field is the least significant bit (lsb). Whenever a multi-octet field represents a numeric quantity, the left-most bit of the entire field is the msb.

When specific bits of fields are numbered, the msb is assigned the highest number, unless otherwise noted. For example, a 32-bit field is numbered from bit 31 down to bit 0, where bit 31 is the msb.

This bit numbering convention differs from the conventions defined in [Chapter 4](#) and the IP specification. [Table B-1](#) shows the differences between these different bit-numbering conventions.

Table B-1. Bit Numbering Conventions									
Standard	Bit Numbering Convention	Single Octet Bit Numbering							
		msb						lsb	
IRIG Chapter 21-28	lsb 0	7	6	5	4	3	2	1	0

IRIG <a href="#">Chapter 4</a>	msb 1	1	2	3	4	5	6	7	8
IP Specification	msb 0	0	1	2	3	4	5	6	7
Example Octet Data (0xAB)		1	0	1	0	1	0	1	1

### B.3. Octet (Byte) Ordering

Octet ordering is important for correct interpretation of multi-octet fields in all TmNS-specific message structures. Unless otherwise noted, these chapters specify the big-endian convention for octet ordering, which states that whenever a multi-octet field represents a numeric quantity, the most significant octet is transmitted first and stored in the memory location with the lowest address.

 <b>NOTE</b>	The following table illustrates both big-endian and little-endian octet ordering for a 32-bit field with a value of 0x9A8B7C6D.				
	<i>Big-endian Transmission Order/ Byte Address</i>	0	1	2	3
	<i>32-bit field (4 bytes)</i>	0x9A	0x8B	0x7C	0x6D
	<i>Little-endian Transmission Order/ Byte Address</i>	3	2	1	0

## APPENDIX 21-C

### Citations

- Institute of Electrical and Electronics Engineers. *IEEE Standard for a Precision Clock Synchronization Protocol for Networked Measurement and Control Systems*. IEEE 1588-2008. Geneva: International Electrotechnical Commission, 2008.
- Internet Engineering Task Force. “Key Words for Use in RFCs to Indicate Requirement Level.” RFC 2119. March 1997. Updated by RFC 8174. Retrieved 17 May 2021. Available at <https://datatracker.ietf.org/doc/rfc2119/>.
- . “Structure of Management Information Version 2 (SMIPv2).” RFC 2578. April 1999. May be superseded or amended by update. Retrieved 17 May 2021. Available at <https://datatracker.ietf.org/doc/rfc2578/>.
- . “Textual Conventions for SMIPv2.” RFC 2579. April 1999. May be superseded or amended by update. Retrieved 17 May 2021. Available at <https://datatracker.ietf.org/doc/rfc2579/>.
- National Institute of Standards and Technology. “Specification for the Advanced Encryption Standard (AES).” FIPS PUB 197. 26 November 2001. May be superseded by update. Retrieved 17 May 2021. Available at <http://nvlpubs.nist.gov/nistpubs/FIPS/NIST.FIPS.197.pdf>.
- World Wide Web Consortium. “Declaration Components” in *XML Schema Part 1: Structures* Second Edition. 28 October 2004. May be superseded by update. Retrieved 17 May 2021. Available at [http://www.w3.org/TR/xmlschema-1/#Declarations\\_Summary](http://www.w3.org/TR/xmlschema-1/#Declarations_Summary).

**\*\*\*\* END OF CHAPTER 21 \*\*\*\***

## CHAPTER 22

### Network-Based Protocol Suite

<b>Acronyms</b> .....	<b>22-iii</b>
<b>Chapter 22. Network-Based Protocol Suite</b> .....	<b>22-1</b>
<b>22.1 General</b> .....	<b>22-1</b>
22.1.1 General <i>NetworkNode</i> Requirements.....	22-2
22.1.2 General <i>NetworkDevice</i> Requirements.....	22-2
<b>22.2 Network Access Layer</b> .....	<b>22-2</b>
22.2.1 Physical Layer.....	22-2
22.2.2 Data Link Layer Protocols.....	22-4
<b>22.3 Internet Layer Protocols</b> .....	<b>22-5</b>
22.3.1 Internet Protocol version 4.....	22-5
22.3.2 Internet Protocol version 6 (IPv6).....	22-6
22.3.3 IP Datagram Transmission.....	22-7
22.3.4 Protocol Independent Multicast.....	22-7
22.3.5 Network Routing.....	22-7
<b>22.4 Transport Layer Protocols</b> .....	<b>22-8</b>
22.4.1 Transmission Control Protocol.....	22-8
22.4.2 User Datagram Protocol (UDP).....	22-8
22.4.3 Transport Layer Security (TLS) and Secure Sockets Layer (SSL).....	22-8
<b>22.5 Application Layer Protocols</b> .....	<b>22-9</b>
22.5.1 Core <i>NetworkNode</i> Protocols.....	22-9
22.5.2 Core <i>TmNSApp</i> Protocols.....	22-11
22.5.3 Quality of Service.....	22-16
<b>Appendix 22-A. Default DSCP Traffic Classification for TmNS-based Systems</b> .....	<b>A-1</b>
<b>Appendix 22-B. Citations</b> .....	<b>B-1</b>

#### List of Figures

Figure 22-1. OSI and TCP/IP Model with TCP/IP Protocol Suite.....	22-1
---	------

#### List of Tables

Table 22-1. Restricted DSCP Assignments.....	22-17
--	-------

This page intentionally left blank.



## Acronyms

**NOTE**  Acronyms in the following list that are marked with an asterisk appear in this document only in titles of referenced materials. Some of the marked acronyms appear only once in the document.

*ADPCM	Adaptive Differential Pulse Code Modulation
AES	Advanced Encryption Standard
*CIDR	Classless Inter-Domain Router
*CRL	Certificate Revocation List
*DHCP	Dynamic Host Configuration Protocol
*DiffServ	Differentiated Services
DSCP	Differentiated Services Code Point
FTP	File Transfer Protocol
GPS	Global Positioning System
*HAIBE	High Assurance Internet Protocol Encryptor
HTTP	Hypertext Transfer Protocol
ICMP	Internet Control Message Protocol
IGMP	Internet Group Management Protocol
IP	Internet Protocol
IPv4	Internet Protocol version 4
ITU	International Telecommunication Union
LLC	logical link control
MAC	media access control
MLD	Multicast Listener Discovery
OSI	Open Systems Interconnection
*PCM	Pulse Code Modulation
*PIM-SM	Protocol-Independent Multicast-Sparse Mode
PPS	pulse per second
PTP	Precision Time Protocol
RCC	Range Commanders Council
RF	radio frequency
RFC	Request for Comment
RTSP	Real-Time Streaming Protocol
SNMP	Simple Network Management Protocol
SOQPSK	shaped offset quadrature phase shift keying
SSL	Secure Sockets Layer
TCP	Transmission Control Protocol
TLS	Transport Layer Security
TMA	TmNS manageable application
TmNS	Telemetry Network Standard
UDP	User Datagram Protocol
URI	Uniform Resource Identifier
URN	Uniform Resource Name
*USM	User-based Security Model

\*VACM                      View-based Access Control Model

## CHAPTER 22

### Network-Based Protocol Suite

#### 22.1 General

The Telemetry Network Standard (TmNS) leverages existing standardized Internet protocols to serve as the core set of communication protocols used by *NetworkNodes* within a *TmNS Network*. The TmNS’s network-based protocol suite incorporates a large portion of the Transmission Control Protocol (TCP)/Internet Protocol (IP) Protocol Suite (also known as the Internet Protocol Suite) along with other supporting technologies (e.g., underlying data link and physical layer technologies). [Figure 22-1](#) illustrates the Open Systems Interconnection (OSI) Model, the corresponding TCP/IP Model, and the major components of the TCP/IP Protocol Suite.

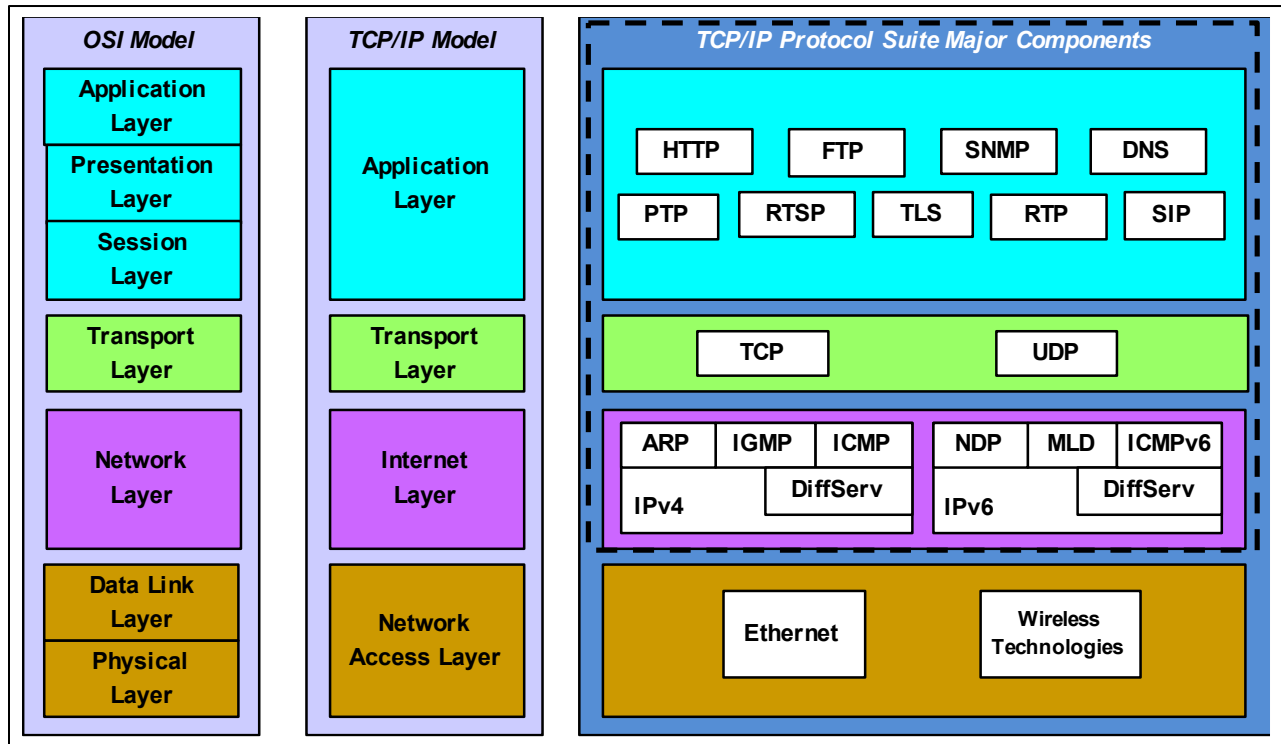

Figure 22-1. OSI and TCP/IP Model with TCP/IP Protocol Suite

This document follows the TCP/IP Model layering convention and consists of the following major sections.

- **Network Access Layer:** Consists of the Physical and Data Link layers that define the underlying hardware networking technology. The networking scope of this layer is limited to the local network connection.
- **Internet Layer Protocols:** Responsible for sending datagrams across potentially multiple networks. Internetworking (i.e., routing) requires sending data from the source network to the destination network.

- **Transport Layer Protocols:** Establishes a basic data channel that an application uses to exchange data.
- **Application Layer Protocols:** Includes protocols used by applications for exchanging application data over the network connections established by the lower-level protocol. Basic network support services are also included (e.g., routing and host configuration protocols).

The bit numbering, bit ordering, and byte ordering conventions used in this chapter are described in [Chapter 21](#) Appendix 21-B.

#### 22.1.1 General *NetworkNode* Requirements

*NetworkNodes* with host functionality shall conform to the following standards that specify host functionality requirements.

- Request for Comment (RFC) 1122: Requirements for Internet Hosts – Communication Layers<sup>1</sup>
- RFC 1123: Requirements for Internet Hosts – Application and Support<sup>2</sup>

#### 22.1.2 General *NetworkDevice* Requirements

*NetworkDevices* that support IP version 4 (IPv4) routing shall conform to RFC 1812: Requirements for IP Version 4 Routers<sup>3</sup>, which specifies routing functionality requirements.

### 22.2 Network Access Layer

#### 22.2.1 Physical Layer

Connectors and cable media should meet the electrical or optical properties required by the applicable standards referenced herein; however, applicability to the selected operational environment will place additional constraints on the selection of the connectors and cable media.

##### 22.2.1.1 Wired Ethernet

*NetworkNodes* shall support one or more of the bit rate and physical protocol standards specified below.

---

<sup>1</sup> Internet Engineering Task Force. “Requirements for Internet Hosts – Communication Layers.” RFC 1122. October 1989. Updated by RFC 8029, RFC 6864, RFC 6093, RFC 5884, RFC 1349, RFC 6298, RFC 6633, and RFC 4379. Retrieved 17 May 2021. Available at <https://datatracker.ietf.org/doc/rfc1122/>.

<sup>2</sup> Internet Engineering Task Force. “Requirements for Internet Hosts – Application and Support.” RFC 1123. October 1989. Updated by RFC 5966, RFC 2181, RFC 5321, RFC 7766, and RFC 1349. Retrieved 17 May 2021. Available at <https://datatracker.ietf.org/doc/rfc1123/>.

<sup>3</sup> Internet Engineering Task Force. “Requirements for IP Version 4 Routers.” RFC 1812. June 1995. Updated by RFC 2644 and RFC 6633. Retrieved 17 May 2021. Available at <https://datatracker.ietf.org/doc/rfc1812/>.

#### 22.2.1.1.1 100 megabits per second Ethernet

##### 22.2.1.1.1.1 100BASE-TX

Copper media connections using 100BASE-TX Ethernet shall comply with IEEE 802.3-2012<sup>4</sup>, Section 2, Clause 25.

##### 22.2.1.1.1.2 100BASE-FX

Multi-mode fiber media connections using 100BASE-FX Ethernet shall comply with IEEE 802.3-2012, Section 2, Clause 26.

#### 22.2.1.1.2 Gigabit Ethernet

##### 22.2.1.1.2.1 1000BASE-T

Copper media connections using 1000BASE-T Ethernet shall comply with IEEE 802.3-2012, Section 3, Clause 40.

##### 22.2.1.1.2.2 1000BASE-SX

Multi-mode fiber media connections using 1000BASE-SX Ethernet shall comply with IEEE 802.3-2012, Section 3, Clause 38.

##### 22.2.1.1.2.3 1000BASE-LX

Multi-mode or single-mode fiber media connections using 1000BASE-LX Ethernet shall comply with IEEE 802.3-2012, Section 3, Clause 38.

#### 22.2.1.1.3 10 Gigabit Ethernet

##### 22.2.1.1.3.1 10GBASE-T

Copper media connections using 10 Gigabit Ethernet shall comply with IEEE 802.3-2012, Section 5, Clause 55.

##### 22.2.1.1.3.2 10GBASE-SR, 10GBASE-LR, 10GBASE-ER

Fiber media connections using 10 Gigabit Ethernet shall comply with IEEE 802.3-2012, Section 5, Clause 52.

#### 22.2.1.1.4 Auto-Negotiation

##### 22.2.1.1.4.1 Copper Auto-Negotiation

Copper media connections, as described in the preceding sections, shall support auto-negotiation of speed, duplex, and flow control in the manner specified in IEEE 802.3-2012, Section 2, Clause 28.

##### 22.2.1.1.4.2 Fiber Auto-Negotiation

Gigabit and 10 Gigabit fiber media connections, as described in the preceding sections, should support auto-negotiation of speed, duplex, and flow control in the manner specified in IEEE 802.3-2012, Section 3, Clause 37.

---

<sup>4</sup> Institute of Electrical and Electronics Engineers. *IEEE standard for ethernet*. IEEE Std 802.3-2012. New York: Institute of Electrical and Electronics Engineers, 2012.

### 22.2.1.2 Wireless Technologies

The radio frequency waveform of the Radio Access Network radios shall comply with the Range Commanders Council (RCC)-Telemetry Group variant of the shaped offset quadrature phase shift keying (SOQPSK-TG) ternary constant phase modulation as defined in [Chapter 2](#) Subsection 2.4.3.2.

[Chapter 27](#) provides more details regarding the characteristics of the SOQPSK-TG single-carrier waveform.

 <p><b>NOTE</b></p>	<p>Future revisions of this standard may include 802.11 technologies (wireless Ethernet).</p>
--	---

### 22.2.2 Data Link Layer Protocols

*NetworkNodes* shall support the Ethernet data link protocols as specified in IEEE 802.3-2012.

#### 22.2.2.1 Frame Structure

*NetworkNodes* shall support the frame structure, field definitions, and media access control (MAC) conventions specified in IEEE 802.3-2012, Section 1, Clauses 2, 3, and 4.

Data link frames shall support 48-bit locally and universally administered addresses in a manner consistent with IEEE 802.3-2012, Section 1, Clause 3, Paragraph 3.2.3, and Clause 4, Paragraph 4.2.

Data link frame structures shall support type-encapsulated and length-encapsulated frames as specified in IEEE 802.3-2012, Section 1, Clause 3, Paragraph 3.2.6.

#### 22.2.2.2 Media Access Control

*NetworkNodes* shall support the MAC protocols specified in IEEE 802.3-2012, Section 1, Clauses 2, 3, and 4.

The MAC protocols shall convey type and length-encapsulated frames to support IP network layer protocols.

#### 22.2.2.3 Logical Link Control (LLC)

*NetworkNodes* shall support the LLC protocols as specified in IEEE 802.2-1998<sup>5</sup> to the extent necessary to support IP network layer protocols.

---

<sup>5</sup> Institute of Electrical and Electronics Engineers. *Information technology – telecommunications and information exchange between systems – local and metropolitan area networks – specific requirements – part 2: logical link control*. IEEE 802.2-1998. New York: Institute of Electrical and Electronics Engineers, 1998.

#### 22.2.2.4 Link Layer Switching

*NetworkDevices* that perform link layer switching shall conform to the requirements set forth in IEEE 802.1D-2004<sup>6</sup> for Rapid Spanning Tree Protocol functionality.

#### 22.2.2.5 Link Layer Bridging

*NetworkDevices* that perform link layer bridging shall conform to the requirements set forth in IEEE 802.1D-2004 for transparent bridging.

#### 22.2.2.6 Link Layer Flow Control

*NetworkNodes* that support full-duplex Ethernet shall support flow control “PAUSE” frames as specified in IEEE 802.3-2012, Section 3, Clause 31.

#### 22.2.2.7 Address Resolution

##### 22.2.2.7.1 Address Resolution Protocol for IPv4

*NetworkNodes* that support IPv4 shall conform to RFC 826: Ethernet Address Resolution Protocol.<sup>7</sup>

##### 22.2.2.7.2 Neighbor Discovery Protocol for IPv6

*NetworkNodes* that support IPv6 shall conform to the following core link-layer address resolution standards.

- RFC 4861: Neighbor Discovery for IP version 6 (IPv6)<sup>8</sup>
- RFC 4862: IPv6 Stateless Address Autoconfiguration<sup>9</sup>

### 22.3 Internet Layer Protocols

#### 22.3.1 Internet Protocol version 4

*NetworkNodes* shall conform to the following IPv4 core standards.

- RFC 791: Internet Protocol<sup>10</sup>
- RFC 919: Broadcasting Internet Datagrams<sup>11</sup>

---

<sup>6</sup> Institute of Electrical and Electronics Engineers. *IEEE standard for local and metropolitan area networks: media access control (MAC) bridges*. IEEE 802.1-D-2004. New York: Institute of Electrical and Electronics Engineers, 2004.

<sup>7</sup> Internet Engineering Task Force. “An Ethernet Address Resolution Protocol.” RFC 826. November 1982. Updated by RFC 5227 and RFC 5494. Retrieved 17 May 2021. Available at <https://datatracker.ietf.org/doc/rfc826/>.

<sup>8</sup> Internet Engineering Task Force. “Neighbor Discovery for IP version 6 (IPv6).” RFC 4861. Updated by RFC 7559, RFC 5942, RFC 6980, RFC 8028, RFC 7527, RFC 8425, RFC 8319, and RFC 7048. September 2007. Retrieved 17 May 2021. Available at <https://datatracker.ietf.org/doc/rfc4861/>.

<sup>9</sup> Internet Engineering Task Force. “IPv6 Stateless Address Autoconfiguration.” RFC 4862. Updated by RFC 7527. September 2007. Retrieved 17 May 2021. Available at <https://datatracker.ietf.org/doc/rfc4862/>.

<sup>10</sup> Internet Engineering Task Force. “Internet Protocol.” RFC 791. Updated by RFC 2474, RFC 6864, and RFC 1349. September 1981. Retrieved 17 May 2021. Available at <https://datatracker.ietf.org/doc/rfc791/>.

<sup>11</sup> Internet Engineering Task Force. “Broadcasting Internet Datagrams.” RFC 919. May be superseded or amended by update. October 1984. Retrieved 17 May 2021. Available at <https://datatracker.ietf.org/doc/rfc919/>.

- RFC 922: Broadcasting Internet Datagrams in the Presence of Subnets<sup>12</sup>

#### 22.3.1.1 Internet Control Message Protocol (ICMP)

*NetworkNodes* shall conform to RFC 792: Internet Control Message Protocol<sup>13</sup> and shall include support for ICMP broadcast pings.

#### 22.3.1.2 Internet Group Management Protocol (IGMP)

*NetworkNodes* that consume or forward dynamically configured IPv4 multicast datagrams shall conform to RFC 3376, Internet Group Management Protocol, Version 3.<sup>14</sup>

Switching *NetworkDevices* should use IGMP snooping as presented in RFC 4541: Considerations for Internet Group Management Protocol (IGMP) and Multicast Listener Discovery (MLD) Snooping Switches.<sup>15</sup> Such switching *NetworkDevices* shall use at least one of the methods B or C in Subsection 2.1.1.1 of RFC 4541.

 <b>NOTE</b>	IGMP Snooping is recommended for performance considerations in a dynamically configured IPv4 multicast environment.
---	---

#### 22.3.2 Internet Protocol version 6 (IPv6)

*NetworkNodes* that support IPv6 shall conform to RFC 2460: Internet Protocol, Version 6 (IPv6) Specification.<sup>16</sup>

##### 22.3.2.1 Internet Control Message Protocol Version 6 (ICMPv6)

*NetworkNodes* that support IPv6 shall conform to RFC 4443: Internet Control Message Protocol (ICMPv6) for the Internet Protocol Version 6 (IPv6) Specification.<sup>17</sup>

##### 22.3.2.2 Multicast Listener Discovery for IPv6

*NetworkDevices* that support IPv6 should conform to the following MLD standards.

---

<sup>12</sup> Internet Engineering Task Force. “Broadcasting Internet Datagrams in the Presence of Subnets.” RFC 922. May be superseded or amended by update. October 1984. Retrieved 17 May 2021. Available at <https://datatracker.ietf.org/doc/rfc922/>.

<sup>13</sup> Internet Engineering Task Force. “Internet Control Message Protocol.” RFC 792. Updated by RFC 950, RFC 4884, RFC 6633, and RFC 6918. September 1981. Retrieved 17 May 2021. Available at <https://datatracker.ietf.org/doc/rfc792/>.

<sup>14</sup> Internet Engineering Task Force. “Internet Group Management Protocol, Version 3.” RFC 3376. Updated by RFC 4604. October 2002. Retrieved 17 May 2021. Available at <https://datatracker.ietf.org/doc/rfc3376/>.

<sup>15</sup> Internet Engineering Task Force. “Considerations for Internet Group Management Protocol (IGMP) and Multicast Listener Discovery (MLD) Snooping Switches.” RFC 4541. May be superseded or amended by update. Retrieved 17 May 2021. Available at <https://datatracker.ietf.org/doc/rfc4541/>.

<sup>16</sup> Internet Engineering Task Force. “Internet Protocol, Version 6 (IPv6) Specification.” RFC 2460. Obsolete by RFC 8200. December 1998. Retrieved 17 May 2021. Available at <https://datatracker.ietf.org/doc/rfc2460/>.

<sup>17</sup> Internet Engineering Task Force. “Internet Control Message Protocol (ICMPv6) for the Internet Protocol Version 6 (IPv6) Specification.” Updated by RFC 4884. March 2006. Retrieved 17 May 2021. Available at <https://datatracker.ietf.org/doc/rfc4443/>.



- RFC 3810: Multicast Listener Discovery Version 2 (MLDv2) for IPv6<sup>18</sup>
- RFC 4604: Using Internet Group Management Protocol Version 3 (IGMPv3) and Multicast Listener Discovery Protocol Version 2 (MLDv2) for Source-Specific Multicast<sup>19</sup>

### 22.3.3 IP Datagram Transmission

*NetworkNodes* shall conform to the following core standards for the transmission of IP datagrams.

- RFC 894: A Standard for the Transmission of IP Datagrams over Ethernet Networks<sup>20</sup>
- RFC 1042: A Standard for the Transmission of IP Datagrams over IEEE 802 Networks<sup>21</sup>

### 22.3.4 Protocol Independent Multicast

*NetworkDevices* that perform routing functions shall conform to RFC 4601: Protocol Independent Multicast – Sparse Mode (PIM-SM) Protocol Specification (Revised).<sup>22</sup>

### 22.3.5 Network Routing

*NetworkNodes* (which includes *NetworkDevices*) shall be capable of being configured to use static routes as defined in Section 7.4 of RFC 1812.

 <b>NOTE</b>	It is expected that this capability is a default capability provided by the host operating system (e.g. the linux <i>route</i> command).
---	--

*NetworkDevices* that provide network-layer services shall be capable of being configured to use static routes for unicast and multicast traffic.

*NetworkDevices* that provide IPv4 routing functionality should be capable of running the interior routing protocol found in RFC 2328: OSPF Version 2.<sup>23</sup>

---

<sup>18</sup> Internet Engineering Task Force. “Multicast Listener Discover Version 2 (MLDv2) for IPv6.” RFC 3810.

Updated by RFC 4604. June 2004. Retrieved 17 May 2021. Available at <https://datatracker.ietf.org/doc/rfc3810/>.

<sup>19</sup> Internet Engineering Task Force. “Using Internet Group Management Protocol Version 3 (IGMPv3) and Multicast Listener Discovery Protocol Version 2 (MLDv2) for Source-Specific Multicast.” RFC 4604. May be superseded or amended by update. Retrieved 17 May 2021. Available at <https://datatracker.ietf.org/doc/rfc4604/>.

<sup>20</sup> Internet Engineering Task Force. “A Standard for the Transmission of IP Datagrams over Ethernet Networks.” RFC 894. May be superseded or amended by update. Retrieved 17 May 2021. Available at <https://datatracker.ietf.org/doc/rfc894/>.

<sup>21</sup> Internet Engineering Task Force. “A Standard for the Transmission of IP Datagrams over IEEE 802 Networks.” RFC 1042. February 1988. May be superseded or amended by update. Retrieved 17 May 2021. Available at <https://datatracker.ietf.org/doc/rfc1042/>.

<sup>22</sup> Internet Engineering Task Force. “Protocol Independent Multicast – Sparse Mode (PIM-SM) Protocol Specification.” RFC 4601. Obsoleted by RFC 7761. August 2006. Retrieved 17 May 2021. Available at <https://datatracker.ietf.org/doc/rfc4601/>.

<sup>23</sup> Internet Engineering Task Force. “OSPF Version 2.” RFC 2328. Updated by RFC 6845, RFC 5709, RFC 8042, RFC 7474, RFC 6549, and RFC 6860. April 1998. Retrieved 17 May 2021. Available at <https://datatracker.ietf.org/doc/rfc2328/>.

*NetworkDevices* that provide IPv6 routing functionality should be capable of running the following interior routing protocol: RFC 5340: OSPF for IPv6.<sup>24</sup>

## 22.4 Transport Layer Protocols

### 22.4.1 Transmission Control Protocol

*NetworkNodes* that implement TCP shall conform to RFC 793: Transmission Control Protocol.<sup>25</sup>

*NetworkNodes* using TCP shall conform to RFC 5681: TCP Congestion Control.<sup>26</sup>

### 22.4.2 User Datagram Protocol (UDP)

*NetworkNodes* that implement UDP shall conform to RFC 768: User Datagram Protocol.<sup>27</sup>

### 22.4.3 Transport Layer Security (TLS) and Secure Sockets Layer (SSL)

*NetworkNodes* that implement TLS and/or SSL shall conform to the following standards for cryptographic protocols.

- RFC 6101: The Secure Sockets Layer (SSL) Protocol Version 3.0<sup>28</sup>
- RFC 5246: The Transport Layer Security (TLS) Protocol Version 1.2<sup>29</sup>

 <b>NOTE</b>	It is anticipated that the TmNS will update and follow the latest government guidance for selection of the exact SSL and TLS versions to use.
--	---

Certificate generation and exchanges shall be in accordance with the profile identified in RFC 5280: Internet X.509 Public Key Infrastructure Certificate and Certificate Revocation List (CRL) Profile.<sup>30</sup>

---

<sup>24</sup> Internet Engineering Task Force. “OSPF for IPv6.” RFC 5340. Updated by RFC 7503, RFC 6845, RFC 8362, and RFC 6860. July 2008. Retrieved 17 May 2021. Available at <https://datatracker.ietf.org/doc/rfc5340/>.

<sup>25</sup> Internet Engineering Task Force. “Transmission Control Protocol.” RFC 793. Updated by RFC 6093, RFC 3168, RFC 1122, and RFC 6528. September 1981. Retrieved 17 May 2021. Available at <https://datatracker.ietf.org/doc/rfc793/>.

<sup>26</sup> Internet Engineering Task Force. “TCP Congestion Control.” RFC 5681. September 2009. May be superseded or amended by update. Retrieved 17 May 2021. Available at <https://datatracker.ietf.org/doc/rfc5681/>.

<sup>27</sup> Internet Engineering Task Force. “User Datagram Protocol.” RFC 768. 28 August 1980. May be superseded or amended by update. Retrieved 17 May 2021. Available at <https://datatracker.ietf.org/doc/rfc768/>.

<sup>28</sup> Internet Engineering Task Force. “The Secure Sockets Layer (SSL) Protocol Version 3.0.” RFC 6101. August 2011. May be superseded or amended by update. Retrieved 17 May 2021. Available at <https://datatracker.ietf.org/doc/rfc6101/>.

<sup>29</sup> Internet Engineering Task Force. “The Transport Layer Security (TLS) Protocol Version 1.2.” RFC 5246. Obsolete by RFC 8446. August 2008. Retrieved 17 May 2021. Available at <https://datatracker.ietf.org/doc/rfc5246/>.

<sup>30</sup> Internet Engineering Task Force. “Internet X.509 Public Key Infrastructure Certificate and Certificate Revocation List (CRL) Profile.” RFC 5280. Updated by RFC 6818, RFC 8398, and RFC 8399. May 2008. Retrieved 17 May 2021. Available at <https://datatracker.ietf.org/doc/rfc5280/>.

## 22.5 Application Layer Protocols

### 22.5.1 *Core NetworkNode* Protocols

#### 22.5.1.1 Host/Address Configuration

*NetworkNodes* requiring IPv4 addressing should conform to RFC 4632: Classless Inter-Domain Routing (CIDR): The Internet Address Assignment and Aggregation Plan.<sup>31</sup>

*NetworkNodes* requiring IPv6 addressing should conform to RFC 4291: IP Version 6 Addressing Architecture.<sup>32</sup>

##### 22.5.1.1.1 *Static Configuration*

*NetworkNodes* requiring IPv4 address configuration shall support static IP address assignment, conforming to RFC 950: Internet Standard Subnetting Procedure.<sup>33</sup>

*NetworkNodes* requiring IPv6 address configuration shall support static IP address assignment.

##### 22.5.1.1.2 *Dynamic Configuration*

A *TmNS Network* incorporating IPv4 shall support dynamic IP address assignment, conforming to RFC 2131: Dynamic Host Configuration Protocol.<sup>34</sup>

A *TmNS Network* incorporating IPv6 shall support IPv6 Stateless Address Autoconfiguration as specified in Subsection [22.2.2.7.2](#).

A *TmNS Network* incorporating IPv6 that requires dynamic IP address assignment shall conform to RFC 3315: Dynamic Host Configuration Protocol for IPv6 (DHCPv6).<sup>35</sup>

#### 22.5.1.2 Domain Name Services

*NetworkNodes* that use domain name labels shall conform to the following core name service standards.

- RFC 1034: Domain names – concepts and facilities<sup>36</sup>

---

<sup>31</sup> Internet Engineering Task Force. “Classless Inter-domain Routing (CIDR): The Internet Address Assignment and Aggregation Plan.” RFC 4632. August 2006. May be superseded or amended by update. Retrieved 17 May 2021. Available at <https://datatracker.ietf.org/doc/rfc4632/>.

<sup>32</sup> Internet Engineering Task Force. “IP Version 6 Addressing Architecture.” RFC 4291. Updated by RFC 7371, RFC 7136, RFC 5952, RFC 8064, RFC 7346, and RFC 6052. February 2006. Retrieved 17 May 2021. Available at <https://datatracker.ietf.org/doc/rfc4291/>.

<sup>33</sup> Internet Engineering Task Force. “Internet Standard Subnetting Procedure.” RFC 950. Updated by RFC 6918. August 1985. Retrieved 17 May 2021. Available at <https://datatracker.ietf.org/doc/rfc950/>.

<sup>34</sup> Internet Engineering Task Force. “Dynamic Host Configuration Protocol.” RFC 2131. Updated by RFC 6842, RFC 4361, RFC 5494, and RFC 3396. March 1997. Retrieved 17 May 2021. Available at <https://datatracker.ietf.org/doc/rfc2131/>.

<sup>35</sup> Internet Engineering Task Force. “Dynamic Host Configuration Protocol for IPv6 (DHCPv6).” RFC 3315. Obsolete by RFC 8415. July 2003. Retrieved 17 May 2021. Available at <https://datatracker.ietf.org/doc/rfc3315/>.

<sup>36</sup> Internet Engineering Task Force. “Domain Names – Concepts and Facilities.” RFC 1034. Updated by many. November 1987. Retrieved 17 May 2021. Available at <https://datatracker.ietf.org/doc/rfc1034/>.

- RFC 1035: Domain names – implementation and specification<sup>37</sup>

### 22.5.1.3 Time Synchronization

*NetworkNodes* requiring network time synchronization shall support network time synchronization as specified in IEEE 1588-2008: Precision Time Protocol (PTP) Version 2.<sup>38</sup>

#### 22.5.1.3.1 IEEE 1588 Master Clock

*NetworkNodes* performing as IEEE 1588 masters shall support the master clock interface as specified in IEEE 1588-2008.

Master clocks compliant with IEEE 1588-2008:

- shall be able to synchronize with an external source;
- should synchronize with the Global Positioning System (GPS) external time reference (see Subsection [22.5.1.3.5](#));
- shall use the PTP epoch when performing as the IEEE 1588 grandmaster clock;
- shall use an internal reference clock that tracks a best estimate of GPS time in the absence of an external time synchronization reference.

#### 22.5.1.3.2 IEEE 1588 Slave Clock

*NetworkNodes* requiring time synchronization to an IEEE 1588-2008 master clock shall support the slave clock interface as specified in IEEE 1588-2008.

Slave clocks shall continue to run freely using the last known time in the absence of a grandmaster clock on the network.

#### 22.5.1.3.3 IEEE 1588 Boundary Clock

*NetworkDevices* that transport time synchronization data to devices requiring a high degree of synchronization shall support boundary clock techniques or approaches that are interoperable with boundary clocks (e.g., transparent clock implementations) as specified in IEEE 1588-2008.

#### 22.5.1.3.4 One Pulse-Per-Second (1 PPS) Outputs on IEEE 1588 Devices

*NetworkNodes* with IEEE 1588-2008 master or slave clocks should support external 1 PPS outputs to allow verification of time signal lock between distributed clocks within one microsecond.

- 1 PPS outputs should be compatible with standard 0-to-5-volts direct current transistor-transistor logic levels.
- The rising edge of the pulse shall define the beginning of a second.
- The duty cycle of the 1 PPS signal shall be between 5% and 95%.

---

<sup>37</sup> Internet Engineering Task Force. “Domain Names – Implementation and Specification.” RFC 1035. Updated by many. November 1987. Retrieved 17 May 2021. Available at <https://datatracker.ietf.org/doc/rfc1035/>.

<sup>38</sup> Institute of Electrical and Electronics Engineers. *IEEE Standard for a Precision Clock Synchronization Protocol for Networked Measurement and Control Systems*. IEEE 1588-2008. Geneva: International Electrotechnical Commission, 2008.

- The pulse rise time between the 10% and 90% amplitude points shall be less than or equal to one microsecond.

#### 22.5.1.3.5 *Global Positioning System*

The GPS external time reference interface shall implement the GPS Space Segment RF waveform interface and the GPS Navigation User Segment interface as specified in IS-GPS-200J, NAVSTAR Global Positioning System (GPS) Interface Specification.<sup>39</sup>

#### 22.5.1.3.6 *TmNS Time Format*

The TmNS-specific time format describes a time format for encoding timestamps in a textual representation.

```
TmNStimestamp = TmNSdate "T" TmNStime
TmNSdate      = 8DIGIT ; < YYYYMMDD >
TmNStime      = 6DIGIT [ "." 1*9DIGIT ] ; < hhmmss.fraction >
```

where:

YYYY is the four-digit year

MM is month (01-12)

DD is day of the month (01-31)

hh is hours on a 24-hour clock (00-23)

mm is minutes (00-59)

ss is seconds (00-59)

fraction is the fractional portion of the seconds

#### 22.5.1.4 Information Assurance and Encryption

##### 22.5.1.4.1 *High Assurance Internet Protocol Encryptor*

*NetworkNodes* that provide Information Assurance services shall comply with High Assurance Internet Protocol Encryptor (HAIPE) Interoperability Specification (IS).

##### 22.5.1.4.2 *Advanced Encryption Standard (AES)*

*NetworkNodes* that support AES data encryption shall comply with NIST FIPS PUB 197: Advanced Encryption Standard (AES).<sup>40</sup>

#### 22.5.2 Core TmNSApp Protocols

##### 22.5.2.1 Simple Network Management Protocol (SNMP)

All *TmNS manageable applications (TMAs)* shall conform to the following management protocol standards.

---

<sup>39</sup> Global Positioning Systems Directorate. "Navstar GPS Space Segment/Navigation User Interfaces." IS-GPS-200J. 25 April 2018. Superseded by IS-GPS-200L. Retrieved 17 May 2021. Available at <https://www.gps.gov/technical/icwg/>.

<sup>40</sup> National Institute of Standards and Technology. "Specification for the Advanced Encryption Standard (AES)." FIPS PUB 197. 26 November 2001. May be superseded by update. Retrieved 17 May 2021. Available at <http://nvlpubs.nist.gov/nistpubs/FIPS/NIST.FIPS.197.pdf>.

- RFC 3411: An Architecture for Describing Simple Network Management Protocol (SNMP) Management Frameworks<sup>41</sup>
- RFC 3413: Simple Network Management Protocol (SNMP) Applications<sup>42</sup>
- RFC 2579: Textual Conventions for SMIV2<sup>43</sup>

[Chapter 25](#) defines the specific SNMP-based resources.

Error handling is detailed by the SNMP RFCs referenced in this document. Some key SNMP protocol error cases are emphasized here for clarity:

- The SNMP exception value of noSuchObject(0) shall be returned for each variable not implemented, as stated in RFC 3416<sup>44</sup>;
- Unsupported enumerations or value ranges shall return an SNMP error-status of inconsistentValue(12), as stated in RFC 3416.

#### 22.5.2.1.1 *SNMP Version 3*

The *TMA*s that implement SNMPv3 shall support the following RFCs.

- RFC 3410: Introduction and Applicability Statements for Internet Standard Management Framework<sup>45</sup>
- RFC 3412: Message Processing and Dispatching for the Simple Network Management Protocol (SNMP)<sup>46</sup>
- RFC 3414: User-based Security Model (USM) for version 3 of the Simple Network Management Protocol (SNMP)<sup>47</sup>
- RFC 3415: View-based Access Control Model (VACM) for the Simple Network Management Protocol (SNMP)<sup>48</sup>

---

<sup>41</sup> Internet Engineering Task Force. “An Architecture for Describing Simple Network Management Protocol (SNMP) Management Frameworks.” RFC 3411. Updated by RFC 5343 and RFC 5590. December 2002. Retrieved 17 May 2021. Available at <https://datatracker.ietf.org/doc/rfc3411/>.

<sup>42</sup> Internet Engineering Task force. “Simple Network Management Protocol (SNMP) Applications.” RFC 3413. May be superseded or amended by update. Retrieved 17 May 2021. Available at <https://datatracker.ietf.org/doc/rfc3413/>.

<sup>43</sup> Internet Engineering Task Force. “Textual Conventions for SMIV2.” RFC 2579. April 1999. May be superseded or amended by update. Retrieved 17 May 2021. Available at <https://datatracker.ietf.org/doc/rfc2579/>.

<sup>44</sup> Internet Engineering Task Force. “Version 2 of the Protocol Operations for the Simple Network Management Protocol (SNMP).” RFC 3416. December 2002. May be superseded or amended by update. Retrieved 17 May 2021. Available at <https://datatracker.ietf.org/doc/rfc3416/>.

<sup>45</sup> Internet Engineering Task Force. “Introduction and Applicability Statements for Internet Standard Management Framework.” RFC 3410. December 2002. May be superseded or amended by update. Retrieved 17 May 2021. Available at <https://datatracker.ietf.org/doc/rfc3410/>.

<sup>46</sup> Internet Engineering Task Force. “Message Processing and Dispatching for the Simple Network Management Protocol (SNMP).” RFC 3412. Updated by RFC 5590. December 2002. 17 May 2021. Available at <https://datatracker.ietf.org/doc/rfc3412/>.

<sup>47</sup> Internet Engineering Task Force. “User-based Security Model (USM) for version 3 of the Simple Network Management Protocol (SNMPv3).” RFC 3414. Updated by RFC 5590. December 2002. Retrieved 17 May 2021. Available at <https://datatracker.ietf.org/doc/rfc3414/>.

<sup>48</sup> Internet Engineering Task Force. “View-based Access Control Model (VACM) for the Simple Network Management Protocol (SNMP).” RFC 3415. December 2002. May be superseded or amended by update. Retrieved 17 May 2021. Available at <https://datatracker.ietf.org/doc/rfc3415/>.

- RFC 3417: Transport Mappings for the Simple Network Management Protocol (SNMP)<sup>49</sup>
- RFC 3826: The Advanced Encryption Standard (AES) Cipher Algorithm in the SNMP User-based Security Model<sup>50</sup>

#### 22.5.2.1.2 *SNMP Version 2c*

The *TMA*s that implement SNMPv2c shall support the following RFCs.

- RFC 1901: Introduction to Community-based SNMPv2<sup>51</sup>
- RFC 2578: Structure of Management Information Version 2 (SMIv2)<sup>52</sup>
- RFC 3416

#### 22.5.2.2 Hypertext Transfer Protocol (HTTP)

The *TmNSApps* that support HTTP shall conform to the following protocol standards.

- RFC 7230: Hypertext Transfer Protocol (HTTP/1.1): Message Syntax and Routing<sup>53</sup>
- RFC 7231: Hypertext Transfer Protocol (HTTP/1.1): Semantics and Content<sup>54</sup>
- RFC 7232: Hypertext Transfer Protocol (HTTP/1.1): Conditional Requests<sup>55</sup>
- RFC 7233: Hypertext Transfer Protocol (HTTP/1.1): Range Requests<sup>56</sup>
- RFC 7234: Hypertext Transfer Protocol (HTTP/1.1): Caching<sup>57</sup>
- RFC 7235: Hypertext Transfer Protocol (HTTP/1.1): Authentication<sup>58</sup>

---

<sup>49</sup> Internet Engineering Task Force. “Transport Mappings for the Simple Network Management Protocol (SNMP).” RFC 3417. Updated by RFC 4789 and R FC 5590. December 2002. Retrieved 17 May 2021. Available at <https://datatracker.ietf.org/doc/rfc3417/>.

<sup>50</sup> Internet Engineering Task Force. “Advanced Encryption Standard (AES) Cipher Algorithm in the SNMP User-based Security Model.” RFC 3826. June 2004. May be superseded or amended by update. Retrieved 17 May 2021. Available at <https://datatracker.ietf.org/doc/rfc3826/>.

<sup>51</sup> Internet Engineering Task Force. “Introduction to Community-based SNMPv2.” RFC 1901. January 1996. May be superseded or amended by update. Retrieved 17 May 2021. Available at <https://datatracker.ietf.org/doc/rfc1901/>.

<sup>52</sup> Internet Engineering Task Force. “Structure of Management Information Version 2 (SMIv2).” RFC 2578. April 1999. May be superseded or amended by update. Retrieved 17 May 2021. Available at <https://datatracker.ietf.org/doc/rfc2578/>.

<sup>53</sup> Internet Engineering Task Force. “Hypertext Transfer Protocol (HTTP/1.1): Message Syntax and Routing.” RFC 7230. June 2014. Updated by RFC 8213. Retrieved 17 May 2021. Available at <https://datatracker.ietf.org/doc/rfc7230/>.

<sup>54</sup> Internet Engineering Task Force. “Hypertext Transfer Protocol (HTTP/1.1): Semantics and Content.” RFC 7231. June 2014. May be superseded or amended by update. Retrieved 17 May 2021. Available at <https://datatracker.ietf.org/doc/rfc7231/>.

<sup>55</sup> Internet Engineering Task Force. “Hypertext Transfer Protocol (HTTP/1.1): Conditional Requests.” RFC 7232. June 2014. May be superseded or amended by update. Retrieved 17 May 2021. Available at <https://datatracker.ietf.org/doc/rfc7232/>.

<sup>56</sup> Internet Engineering Task Force. “Hypertext Transfer Protocol (HTTP/1.1): Range Requests.” RFC 7233. June 2014. May be superseded or amended by update. Retrieved 17 May 2021. Available at <https://datatracker.ietf.org/doc/rfc7233/>.

<sup>57</sup> Internet Engineering Task Force. “Hypertext Transfer Protocol (HTTP/1.1): Caching.” RFC 7234. June 2014. May be superseded or amended by update. Retrieved 17 May 2021. Available at <https://datatracker.ietf.org/doc/rfc7234/>.

<sup>58</sup> Internet Engineering Task Force. “Hypertext Transfer Protocol (HTTP/1.1): Authentication.” RFC 7235. June 2014. May be superseded or amended by update. Retrieved 17 May 2021. Available at <https://datatracker.ietf.org/doc/rfc7235/>.

### 22.5.2.3 Real Time Streaming Protocol (RTSP)

The *TmNSApps* that support TmNS Data Delivery using a *DataDeliveryControlChannel* shall exchange control commands and parameters using RTSP, as specified in RFC 2326: Real Time Streaming Protocol (RTSP).<sup>59</sup>

[Chapter 26](#) defines the *DataDeliveryControlChannel*, which is an augmentation of the RTSP specification.

### 22.5.2.4 File Transfer

The *TmNSApps* that support file transfer services shall support RFC 959: File Transfer Protocol (FTP).<sup>60</sup>

### 22.5.2.5 Voice Over IP

The *TmNSApps* that provide voice services shall comply with one or more of the following Voice over IP standards.

- International Telecommunication Union (ITU) H.323 Packet Based Multimedia Communication<sup>61</sup>
- RFC 3261: SIP: Session Initiation Protocol<sup>62</sup>
- RFC 3550: RTP: A Transport Protocol for Real-Time Applications<sup>63</sup>

The *TmNSApps* that provide voice services shall comply with one or more of the following coder-decoder standards.

- ITU-T G.711 – Pulse Code Modulation (PCM)<sup>64</sup>
- ITU-T G.726 – Adaptive Differential Pulse Code Modulation (ADPCM)<sup>65</sup>

---

<sup>59</sup> Internet Engineering Task Force. “Real Time Streaming Protocol (RTSP).” RFC 2326. Obsolete by RFC 7826. April 1998. Retrieved 17 May 2021. Available at <https://datatracker.ietf.org/doc/rfc2326/>.

<sup>60</sup> Internet Engineering Task Force. “File Transfer Protocol (FTP).” RFC 959. Updated by RFC 3659, RFC 7151, RFC 2640, RFC 2773, RFC 2228, and RFC 5797. October 1985. Retrieved 17 May 2021. Available at <https://datatracker.ietf.org/doc/rfc959/>.

<sup>61</sup> International Telecommunication Union. “Packet-based multimedia communications systems.” ITU-T H.323. December 2009. May be superseded by update. Retrieved 17 May 2021. Available at <https://www.itu.int/rec/T-REC-H.323/en>.

<sup>62</sup> Internet Engineering Task Force. “SIP: Session Initiation Protocol.” RFC 3261. Updated by many. June 2002. Retrieved 17 May 2021. Available at <https://datatracker.ietf.org/doc/rfc3261/>.

<sup>63</sup> Internet Engineering Task Force. “RTP: A Transport Protocol for Real-Time Applications.” RFC 3550. Updated by RFC 7022, RFC 5761, RFC 8108, RFC 8083, RFC 6222, RFC 6051, RFC 5506, RFC 7160, and RFC 7164. July 2003. Retrieved 17 May 2021. Available at <https://datatracker.ietf.org/doc/rfc3550/>.

<sup>64</sup> International Telecommunication Union. “Pulse Code Modulation (PCM) of Voice Frequencies.” ITU-T G.711. 25 November 1988. May be superseded by update. Retrieved 17 May 2021. Available at <https://www.itu.int/rec/T-REC-G.711/en>.

<sup>65</sup> International Telecommunication Union. “40, 32, 24, 16 kbit/s Adaptive Differential Pulse Code Modulation (ADPCM).” ITU-T G.726. 14 December 1990. May be superseded by update. Retrieved 17 May 2021. Available at <https://www.itu.int/rec/T-REC-G.726/en>.



### 22.5.2.6 Secure Communications

The *TmNSApps* requiring secure, reliable network communication over connection-oriented transports shall conform to RFC 5246.

The *TmNSApps* requiring secure network communication over SNMP shall conform to RFC 5953: Transport Layer Security (TLS) Transport Model for the Simple Network Management Protocol (SNMP).<sup>66</sup>

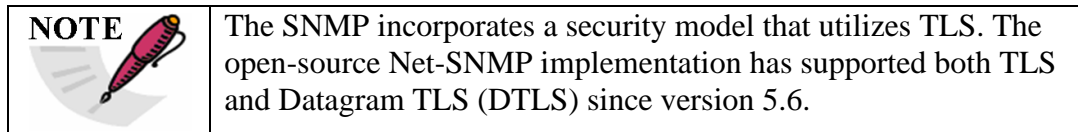
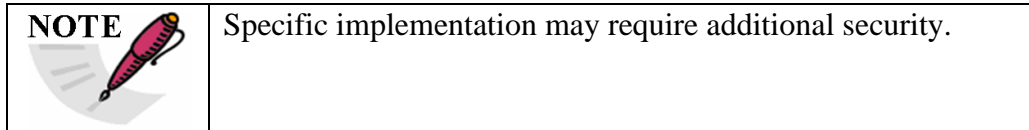

#### 22.5.2.6.1 Secure FTP

The *TmNSApps* that support secure file transfer services shall support the following protocols.

- RFC 2228: FTP Security Extensions<sup>67</sup>
- RFC 4217: Securing FTP with TLS<sup>68</sup>

#### 22.5.2.6.2 Secure HTTP

The *TmNSApps* that support secure HTTP services should follow the recommendations in RFC 2818: HTTP Over TLS.<sup>69</sup>

#### 22.5.2.7 Uniform Resource Identifier (URI)/Uniform Resource Name (URN)

*TmNSApps* shall conform to the following standards governing URI/URN syntax.

- RFC 3986: Uniform Resource Identifier (URI): Generic Syntax<sup>70</sup>

---

<sup>66</sup> Internet Engineering Task Force. “Transport Layer Security (TLS) Transport Model for the Simple Network Management Protocol (SNMP).” RFC 5953. Obsolete by RFC 6353. August 2010. Retrieved 17 May 2021. Available at <https://datatracker.ietf.org/doc/rfc5953/>.

<sup>67</sup> Internet Engineering Task Force. “FTP Security Extensions.” RFC 2228. October 1997. May be superseded or amended by update. Retrieved 17 May 2021. Available at <https://datatracker.ietf.org/doc/rfc2228/>.

<sup>68</sup> Internet Engineering Task Force. “Securing FTP with TLS.” RFC 4217. October 2005. May be superseded or amended by update. Retrieved 17 May 2021. Available at <https://datatracker.ietf.org/doc/rfc4217/>.

<sup>69</sup> Internet Engineering Task Force. “HTTP Over TLS.” RFC 2818. Updated by RFC 5785 and RFC 7230. May 2000. Retrieved 17 May 2021. Available at <https://datatracker.ietf.org/doc/rfc2818/>.

<sup>70</sup> Internet Engineering Task Force. “Uniform Resource Identifier (URI): Generic Syntax.” RFC 3986. Updated by RFC 8820, RFC 7320, and RFC 6874. January 2005. Retrieved 17 May 2021. Available at <https://datatracker.ietf.org/doc/rfc3986/>.

- RFC 3406: Uniform Resource Names (URN) Namespace Definition Mechanisms<sup>71</sup>

<p><b>NOTE</b></p> 	<p>The TmNS-specific URN is not registered. It is anticipated that the RCC may register it in the future.</p>
--	---

### 22.5.3 Quality of Service

#### 22.5.3.1 Differentiated Services (DiffServ)

*NetworkNodes* shall support the DiffServ standards as specified in:

- RFC 2474: Definition of the Differentiated Services Field (DS Field) in the IPv4 and IPv6 Headers<sup>72</sup>;
- RFC 2475: An Architecture for Differentiated Services<sup>73</sup>;
- RFC 2597: Assured Forwarding PHB Group<sup>74</sup>;
- RFC 3140: Per Hop Behavior Identification Codes;<sup>75</sup>
- RFC 3246: An Expedited Forwarding PHB (Per-Hop Behavior);<sup>76</sup>
- RFC 4594: Configuration Guidelines for DiffServ Service Classes.<sup>77</sup>

#### 22.5.3.2 DiffServ Code Point (DSCP) Assignments

*NetworkNodes* shall mark IP packets with DSCP markings as specified through configuration via an MDL file.

The DSCP assignments identified in [Table 22-1](#) have restricted usage and shall only be assigned to network traffic that is directly related to network and internetwork control, such as RF network messages that are exchanged between RF link management and radios.

*NetworkNodes* shall not mark traffic with the restricted DSCP assignments if the traffic is not directly related to network and internetwork control.

<sup>71</sup> Internet Engineering Task Force. “Uniform Resource Names (URN) Namespace Definition Mechanisms.” RFC 3406. October 2002. Obsolete by RFC 8141. Retrieved 17 May 2021. Available at <https://datatracker.ietf.org/doc/rfc3406/>.

<sup>72</sup> Internet Engineering Task Force. “Definition of the Differentiated Services Field (DS Field) in the IPv4 and IPv6 Headers.” RFC 2474. Updated by RFC 3260, RFC 3168, and RFC 8436. December 1998. Retrieved 17 May 2021. Available at <https://datatracker.ietf.org/doc/rfc2474/>.

<sup>73</sup> Internet Engineering Task Force. “An Architecture for Differentiated Services.” RFC 2475. Updated by RFC 3260. December 1998. Retrieved 17 May 2021. Available at <https://datatracker.ietf.org/doc/rfc2475/>.

<sup>74</sup> Internet Engineering Task Force. “Assured Forwarding PHB Group.” RFC 2597. Updated by RFC 3260. June 1999. Retrieved 17 May 2021. Available at <https://datatracker.ietf.org/doc/rfc2597/>.

<sup>75</sup> Internet Engineering Task Force. “Per Hop Behavior Identification Codes.” RFC 3140. June 2001. May be superseded or amended by update. Retrieved 17 May 2021. Available at <https://datatracker.ietf.org/doc/rfc3140/>.

<sup>76</sup> Internet Engineering Task Force. “An Expedited Forwarding PHB (Per Hop Behavior).” RFC 3246. March 2002. May be superseded or amended by update. Retrieved 17 May 2021. Available at <https://datatracker.ietf.org/doc/rfc3246/>.

<sup>77</sup> Internet Engineering Task Force. “Configuration Guidelines for DiffServ Service Classes.” RFC 4594. Updated by RFC 5865 and RFC 8622. August 2006. Retrieved 17 May 2021. Available at <https://datatracker.ietf.org/doc/rfc4594/>.

<b>Table 22-1. Restricted DSCP Assignments</b>			
DSCP Class	IP Precedence	DSCP Range	Comment
6	Internetwork Control	6'b110000 (6'd48) – 6'b110111 (6'd55)	Used for IP routing protocols
7	Network Control	6'b111000 (6'd56) – 6'b111111 (6'd63)	Link layer and routing protocol keep alive

*NetworkDevices* forwarding IP packets with unrecognized DSCP values shall forward the packets with the DSCP value unchanged but queue the packets using the PHB of 6'b000000.

This page intentionally left blank.

**APPENDIX 22-A****Default DSCP Traffic Classification for TmNS-based Systems**

The DSCP markings to be assigned to network traffic in a TmNS-based system are described in the MDL configuration file for the test. The default DSCP markings to be associated with different types of traffic in a TmNS-based system are described in [Table A-1](#).

<b>Table A-1. DSCP Traffic Classifications for TmNS-based Systems</b>		
<b>IEEE 802.1Q PCP – IEEE P802.1p</b>	<b>DSCP Category Description</b>	<b>Expected Use Within TmNS-based System</b>
<b>0 – Best Effort</b>	Best Effort	DSCP 0: General Network Traffic (e.g. FTP)
<b>1 – Background</b>	Class 1	DSCP 8: RC Delivery at Normal Priority & System Management Status
<b>2 – Excellent Effort</b>	Class 2	DSCP 16: LTC Delivery
<b>3 – Critical Applications</b>	Class 3	DSCP 24: RC Delivery at High Priority
<b>4 – “Video,” &lt; 100 ms latency &amp; jitter</b>	Class 4	DSCP 32: System Management Control & Video
<b>5 – “Voice,” &lt; 10 ms latency and jitter</b>	Expedited Forwarding (EF)	DSCP 40: Voice
<b>6 – Internetwork Control</b>	Control (used for IP routing protocols)	DSCP 48: RF Network Messages
<b>7 – Network Control</b>	Control (link layer and routing protocol keep alive)	DSCP 56: RF Network Messages

This page intentionally left blank.

## APPENDIX 22-B

### Citations

- Global Positioning Systems Directorate. “Navstar GPS Space Segment/Navigation User Interfaces.” IS-GPS-200J. 25 April 2018. Superseded by IS-GPS-200L. Retrieved 17 May 2021. Available at <https://www.gps.gov/technical/icwg/>.
- Institute of Electrical and Electronics Engineers. *IEEE standard for Ethernet*. IEEE Std 802.3-2012. New York: Institute of Electrical and Electronics Engineers, 2012.
- . *IEEE standard for local and metropolitan area networks: media access control (MAC) bridges*. IEEE 802.1-D-2004. New York: Institute of Electrical and Electronics Engineers, 2004.
- . *IEEE Standard for a Precision Clock Synchronization Protocol for Networked Measurement and Control Systems*. IEEE 1588-2008. Geneva: International Electrotechnical Commission, 2008.
- . *Information technology – telecommunications and information exchange between systems – local and metropolitan area networks – specific requirements – part 2: logical link control*. IEEE 802.2-1998. New York: Institute of Electrical and Electronics Engineers, 1998.
- International Telecommunications Union. “40, 32, 24, 16 kbit/s Adaptive Differential Pulse Code Modulation (ADPCM).” ITU-T G.726. 14 December 1990. May be superseded by update. Retrieved 17 May 2021. Available at <https://www.itu.int/rec/T-REC-G.726/en>.
- . “Packet-based multimedia communications systems.” ITU-T H.323. December 2009. May be superseded by update. Retrieved 17 May 2021. Available at <https://www.itu.int/rec/T-REC-H.323/en>.
- . “Pulse Code Modulation (PCM) of Voice Frequencies.” ITU-T G.711. 25 November 1988. May be superseded by update. Retrieved 17 May 2021. Available at <https://www.itu.int/rec/T-REC-G.711/en>.
- Internet Engineering Task Force. “A Standard for the Transmission of IP Datagrams over Ethernet Networks.” RFC 894. May be superseded or amended by update. Retrieved 17 May 2021. Available at <https://datatracker.ietf.org/doc/rfc894/>.
- . “A Standard for the Transmission of IP Datagrams over IEEE 802 Networks.” RFC 1042. February 1988. May be superseded or amended by update. Retrieved 17 May 2021. Available at <https://datatracker.ietf.org/doc/rfc1042/>.
- . “Advanced Encryption Standard (AES) Cipher Algorithm in the SNMP User-based Security Model.” RFC 3826. June 2004. May be superseded or amended by update. Retrieved 17 May 2021. Available at <https://datatracker.ietf.org/doc/rfc3826/>.

- . “An Architecture for Describing Simple Network Management Protocol (SNMP) Management Frameworks.” RFC 3411. Updated by RFC 5343 and RFC 5590. December 2002. Retrieved 17 May 2021. Available at <https://datatracker.ietf.org/doc/rfc3411/>.
- . “An Architecture for Differentiated Services.” RFC 2475. Updated by RFC 3260. December 1998. Retrieved 17 May 2021. Available at <https://datatracker.ietf.org/doc/rfc2475/>.
- . “An Ethernet Address Resolution Protocol.” RFC 826. November 1982. Updated by RFC 5227 and RFC 5494. Retrieved 17 May 2021. Available at <https://datatracker.ietf.org/doc/rfc826/>.
- . “An Expedited Forwarding PHB (Per Hop Behavior).” RFC 3246. March 2002. May be superseded or amended by update. Retrieved 17 May 2021. Available at <https://datatracker.ietf.org/doc/rfc3246/>.
- . “Assured Forwarding PHB Group.” RFC 2597. Updated by RFC 3260. June 1999. Retrieved 17 May 2021. Available at <https://datatracker.ietf.org/doc/rfc2597/>.
- . “Broadcasting Internet Datagrams.” RFC 919. May be superseded or amended by update. October 1984. Retrieved 17 May 2021. Available at <https://datatracker.ietf.org/doc/rfc919/>.
- . “Broadcasting Internet Datagrams in the Presence of Subnets.” RFC 922. May be superseded or amended by update. October 1984. Retrieved 17 May 2021. Available at <https://datatracker.ietf.org/doc/rfc922/>.
- . “Classless Inter-domain Routing (CIDR): The Internet Address Assignment and Aggregation Plan.” RFC 4632. August 2006. May be superseded or amended by update. Retrieved 17 May 2021. Available at <https://datatracker.ietf.org/doc/rfc4632/>.
- . “Configuration Guidelines for DiffServ Service Classes.” RFC 4594. Updated by RFC 5865 and RFC 8622. August 2006. Retrieved 17 May 2021. Available at <https://datatracker.ietf.org/doc/rfc4594/>.
- . “Considerations for Internet Group Management Protocol (IGMP) and Multicast Listener Discovery (MLD) Snooping Switches.” RFC 4541. May be superseded or amended by update. Retrieved 17 May 2021. Available at <https://datatracker.ietf.org/doc/rfc4541/>.
- . “Definition of the Differentiated Services Field (DS Field) in the IPv4 and IPv6 Headers.” RFC 2474. Updated by RFC 3260, RFC 3168, and RFC 8436. December 1998. Retrieved 17 May 2021. Available at <https://datatracker.ietf.org/doc/rfc2474/>.
- . “Domain Names – Concepts and Facilities.” RFC 1034. Updated by many. November 1987. Retrieved 17 May 2021. Available at <https://datatracker.ietf.org/doc/rfc1034/>.



- . “Domain Names – Implementation and Specification.” RFC 1035. Updated by many. November 1987. Retrieved 17 May 2021. Available at <https://datatracker.ietf.org/doc/rfc1035/>.
- . “Dynamic Host Configuration Protocol.” RFC 2131. Updated by RFC 6842, RFC 4361, RFC 5494, and RFC 3396. March 1997. Retrieved 17 May 2021. Available at <https://datatracker.ietf.org/doc/rfc2131/>.
- . “Dynamic Host Configuration Protocol for IPv6 (DHCPv6).” RFC 3315. Obsoleted by RFC 8415. July 2003. Retrieved 17 May 2021. Available at <https://datatracker.ietf.org/doc/rfc3315/>.
- . “File Transfer Protocol (FTP).” RFC 959. Updated by RFC 3659, RFC 7151, RFC 2640, RFC 2773, RFC 2228, and RFC 5797. October 1985. Retrieved 17 May 2021. Available at <https://datatracker.ietf.org/doc/rfc959/>.
- . “FTP Security Extensions.” RFC 2228. October 1997. May be superseded or amended by update. Retrieved 17 May 2021. Available at <https://datatracker.ietf.org/doc/rfc2228/>.
- . “HTTP Over TLS.” RFC 2818. Updated by RFC 5785 and RFC 7230. May 2000. Retrieved 17 May 2021. Available at <https://datatracker.ietf.org/doc/rfc2818/>.
- . “Hypertext Transfer Protocol (HTTP/1.1): Authentication.” RFC 7235. June 2014. May be superseded or amended by update. Retrieved 17 May 2021. Available at <https://datatracker.ietf.org/doc/rfc7235/>.
- . “Hypertext Transfer Protocol (HTTP/1.1): Caching.” RFC 7234. June 2014. May be superseded or amended by update. Retrieved 17 May 2021. Available at <https://datatracker.ietf.org/doc/rfc7234/>.
- . “Hypertext Transfer Protocol (HTTP/1.1): Conditional Requests.” RFC 7232. June 2014. May be superseded or amended by update. Retrieved 17 May 2021. Available at <https://datatracker.ietf.org/doc/rfc7232/>.
- . “Hypertext Transfer Protocol (HTTP/1.1): Message Syntax and Routing.” RFC 7230. June 2014. Updated by RFC 8213. Retrieved 17 May 2021. Available at <https://datatracker.ietf.org/doc/rfc7230/>.
- . “Hypertext Transfer Protocol (HTTP/1.1): Range Requests.” RFC 7233. June 2014. May be superseded or amended by update. Retrieved 17 May 2021. Available at <https://datatracker.ietf.org/doc/rfc7233/>.
- . “Hypertext Transfer Protocol (HTTP/1.1): Semantics and Content.” RFC 7231. June 2014. May be superseded or amended by update. Retrieved 17 May 2021. Available at <https://datatracker.ietf.org/doc/rfc7231/>.

- . “Internet Control Message Protocol.” RFC 792. Updated by RFC 950, RFC 4884, RFC 6633, and RFC 6918. September 1981. Retrieved 17 May 2021. Available at <https://datatracker.ietf.org/doc/rfc792/>.
- . “Internet Control Message Protocol (ICMPv6) for the Internet Protocol Version 6 (IPv6) Specification.” RFC 4443. Updated by RFC 4884. March 2006. Retrieved 17 May 2021. Available at <https://datatracker.ietf.org/doc/rfc4443/>.
- . “Internet Group Management Protocol, Version 3.” RFC 3376. Updated by RFC 4604. October 2002. Retrieved 17 May 2021. Available at <https://datatracker.ietf.org/doc/rfc3376/>.
- . “Internet Protocol.” RFC 791. Updated by RFC 2474, RFC 6864, and RFC 1349. September 1981. Retrieved 17 May 2021. Available at <https://datatracker.ietf.org/doc/rfc791/>.
- . “Internet Protocol, Version 6 (IPv6) Specification.” RFC 2460. Obsoleted by RFC 8200. December 1998. Retrieved 17 May 2021. Available at <https://datatracker.ietf.org/doc/rfc2460/>.
- . “Internet Standard Subnetting Procedure.” RFC 950. Updated by RFC 6918. August 1985. Retrieved 17 May 2021. Available at <https://datatracker.ietf.org/doc/rfc950/>.
- . “Internet X.509 Public Key Infrastructure Certificate and Certificate Revocation List (CRL) Profile.” RFC 5280. Updated by RFC 6818, RFC 8398, and RFC 8399. May 2008. Retrieved 17 May 2021. Available at <https://datatracker.ietf.org/doc/rfc5280/>.
- . “Introduction and Applicability Statements for Internet Standard Management Framework.” RFC 3410. December 2002. May be superseded or amended by update. Retrieved 17 May 2021. Available at <https://datatracker.ietf.org/doc/rfc3410/>.
- . “Introduction to Community-based SNMPv2.” RFC 1901. January 1996. May be superseded or amended by update. Retrieved 17 May 2021. Available at <https://datatracker.ietf.org/doc/rfc1901/>.
- . “IP Version 6 Addressing Architecture.” RFC 4291. Updated by RFC 7371, RFC 7136, RFC 5952, RFC 8064, RFC 7346, and RFC 6052. February 2006. Retrieved 17 May 2021. Available at <https://datatracker.ietf.org/doc/rfc4291/>.
- . “IPv6 Stateless Address Autoconfiguration.” RFC 4862. Updated by RFC 7527. September 2007. Retrieved 17 May 2021. Available at <https://datatracker.ietf.org/doc/rfc4862/>.
- . “Message Processing and Dispatching for the Simple Network Management Protocol (SNMP).” RFC 3412. Updated by RFC 5590. December 2002. Retrieved 17 May 2021. Available at <https://datatracker.ietf.org/doc/rfc3412/>.

- . “Multicast Listener Discover Version 2 (MLDv2) for IPv6.” RFC 3810. Updated by RFC 4604. June 2004. Retrieved 17 May 2021. Available at <https://datatracker.ietf.org/doc/rfc3810/>.
- . “Neighbor Discovery for IP version 6 (IPv6).” RFC 4861. Updated by RFC 7559, RFC 5942, RFC 6980, RFC 8028, RFC 7527, RFC 8425, RFC 8319, and RFC 7048. September 2007. Retrieved 17 May 2021. Available at <https://datatracker.ietf.org/doc/rfc4861/>.
- . “OSPF for IPv6.” RFC 5340. Updated by RFC 7503, RFC 6845, RFC 8362, and RFC 6860. July 2008. Retrieved 17 May 2021. Available at <https://datatracker.ietf.org/doc/rfc5340/>.
- . “OSPF Version 2.” RFC 2328. Updated by RFC 6845, RFC 5709, RFC 8042, RFC 7474, RFC 6549, and RFC 6860. April 1998. Retrieved 17 May 2021. Available at <https://datatracker.ietf.org/doc/rfc2328/>.
- . “Per Hop Behavior Identification Codes.” RFC 3140. June 2001. May be superseded or amended by update. Retrieved 17 May 2021. Available at <https://datatracker.ietf.org/doc/rfc3140/>.
- . “Protocol Independent Multicast – Sparse Mode (PIM-SM) Protocol Specification.” RFC 4601. Updated by RFC 5796, RFC 6226, and RFC 5059. August 2006. Retrieved 17 May 2021. Available at <https://datatracker.ietf.org/doc/rfc4601/>.
- . “Real Time Streaming Protocol (RTSP).” RFC 2326. Obsoleted by RFC 7826. April 1998. Retrieved 17 May 2021. Available at <https://datatracker.ietf.org/doc/rfc2326/>.
- . “Requirements for Internet Hosts – Application and Support.” RFC 1123. October 1989. Updated by RFC 5966, RFC 2181, RFC 5321, RFC 7766, and RFC 1349. Retrieved 17 May 2021. Available at <https://datatracker.ietf.org/doc/rfc1123/>.
- . “Requirements for Internet Hosts – Communication Layers.” RFC 1122. October 1989. Updated by RFC 8029, RFC 6864, RFC 6093, RFC 5884, RFC 1349, RFC 6298, RFC 6633, and RFC 4379. Retrieved 17 May 2021. Available at <https://datatracker.ietf.org/doc/rfc1122/>.
- . “Requirements for IP Version 4 Routers.” RFC 1812. June 1995. Updated by RFC 2644 and RFC 6633. Retrieved 17 May 2021. Available at <https://datatracker.ietf.org/doc/rfc1812/>.
- . “RTP: A Transport Protocol for Real-Time Applications.” RFC 3550. Updated by RFC 7022, RFC 5761, RFC 8108, RFC 8083, RFC 6222, RFC 6051, RFC 5506, RFC 7160, and RFC 7164. July 2003. Retrieved 17 May 2021. Available at <https://datatracker.ietf.org/doc/rfc3550/>.
- . “Securing FTP with TLS.” RFC 4217. October 2005. May be superseded or amended by update. Retrieved 17 May 2021. Available at <https://datatracker.ietf.org/doc/rfc4217/>.

- . “Simple Network Management Protocol (SNMP) Applications.” RFC 3413. May be superseded or amended by update. Retrieved 17 May 2021. Available at <https://datatracker.ietf.org/doc/rfc3413/>.
- . “SIP: Session Initiation Protocol.” RFC 3261. Updated by many. June 2002. Retrieved 17 May 2021. Available at <https://datatracker.ietf.org/doc/rfc3261/>.
- . “Structure of Management Information Version 2 (SMIv2).” RFC 2578. April 1999. May be superseded or amended by update. Retrieved 17 May 2021. Available at <https://datatracker.ietf.org/doc/rfc2578/>.
- . “The Secure Sockets Layer (SSL) Protocol Version 3.0.” RFC 6101. August 2011. May be superseded or amended by update. Retrieved 17 May 2021. Available at <https://datatracker.ietf.org/doc/rfc6101/>.
- . “TCP Congestion Control.” RFC 5681. September 2009. May be superseded or amended by update. Retrieved 17 May 2021. Available at <https://datatracker.ietf.org/doc/rfc5681/>.
- . “Textual Conventions for SMIv2.” RFC 2579. April 1999. May be superseded or amended by update. Retrieved 17 May 2021. Available at <https://datatracker.ietf.org/doc/rfc2579/>.
- . “Transmission Control Protocol.” RFC 793. Updated by RFC 6093, RFC 3168, RFC 1122, and RFC 6528. September 1981. Retrieved 17 May 2021. Available at <https://datatracker.ietf.org/doc/rfc793/>.
- . “The Transport Layer Security (TLS) Protocol Version 1.2.” RFC 5246. Obsolete by RFC 8446. August 2008. Retrieved 17 May 2021. Available at <https://datatracker.ietf.org/doc/rfc5246/>.
- . “Transport Layer Security (TLS) Transport Model for the Simple Network Management Protocol (SNMP).” RFC 5953. Obsolete by RFC 6353. August 2010. Retrieved 17 May 2021. Available at <https://datatracker.ietf.org/doc/rfc5953/>.
- . “Transport Mappings for the Simple Network Management Protocol (SNMP).” RFC 3417. Updated by RFC 4789 and RFC 5590. December 2002. Retrieved 17 May 2021. Available at <https://datatracker.ietf.org/doc/rfc3417/>.
- . “Uniform Resource Identifier (URI): Generic Syntax.” RFC 3986. Updated by RFC 8820, RFC 7320, and RFC 6874. January 2005. Retrieved 17 May 2021. Available at <https://datatracker.ietf.org/doc/rfc3986/>.
- . “Uniform Resource Names (URN) Namespace Definition Mechanisms.” RFC 3406. October 2002. Obsolete by RFC 8141. Retrieved 17 May 2021. Available at <https://datatracker.ietf.org/doc/rfc3406/>.

- . “User-based Security Model (USM) for version 3 of the Simple Network Management Protocol (SNMPv3).” RFC 3414. Updated by RFC 5590. December 2002. Retrieved 17 May 2021. Available at <https://datatracker.ietf.org/doc/rfc3414/>.
  - . “User Datagram Protocol.” RFC 768. 28 August 1980. May be superseded or amended by update. Retrieved 17 May 2021. Available at <https://datatracker.ietf.org/doc/rfc768/>.
  - . “Using Internet Group Management Protocol Version 3 (IGMPv3) and Multicast Listener Discovery Protocol Version 2 (MLDv2) for Source-Specific Multicast.” RFC 4604. May be superseded or amended by update. Retrieved 17 May 2021. Available at <https://datatracker.ietf.org/doc/rfc4604/>.
  - . “Version 2 of the Protocol Operations for the Simple Network Management Protocol (SNMP).” RFC 3416. December 2002. May be superseded or amended by update. Retrieved 17 May 2021. Available at <https://datatracker.ietf.org/doc/rfc3416/>.
  - . “View-based Access Control Model (VACM) for the Simple Network Management Protocol (SNMP).” RFC 3415. December 2002. May be superseded or amended by update. Retrieved 17 May 2021. Available at <https://datatracker.ietf.org/doc/rfc3415/>.
- National Institute of Standards and Technology. “Specification for the Advanced Encryption Standard (AES).” FIPS PUB 197. 26 November, 2001. May be superseded by update. Retrieved 17 May 2021. Available at <http://nvlpubs.nist.gov/nistpubs/FIPS/NIST.FIPS.197.pdf>.

**\*\*\*\* END OF CHAPTER 22 \*\*\*\***

## **CHAPTER 23**

### **Metadata Configuration**

<b>Acronyms</b> .....	<b>23-iii</b>
<b>Chapter 23. Metadata Configuration</b> .....	<b>23-1</b>
<b>23.1 Introduction</b> .....	<b>23-1</b>
<b>23.2 Metadata Description Language</b> .....	<b>23-1</b>
23.2.1 MDL Schema Concepts .....	23-1
23.2.2 MDL Global Element Glossary .....	23-3
<b>Appendix 23-A. MDL Examples</b> .....	<b>A-1</b>
<b>Appendix 23-B. MDL Relationships to Chapters</b> .....	<b>B-1</b>
<b>Appendix 23-C. MDL Recommended Best Practices</b> .....	<b>C-1</b>

### **List of Tables**

Table B-1. MDL Mapping to RCC 106 Chapters .....	B-1
Table C-1. MDL Recommended Best Practices .....	C-1

This page intentionally left blank.



## Acronyms

HTML	Hypertext Markup Language
MDL	Metadata Description Language
PCM	pulse code modulation
TMATS	Telemetry Attributes Transfer Standard
W3C	World Wide Web Consortium
XML	eXtensible Markup Language
XSD	XML schema document

This page intentionally left blank.

## CHAPTER 23

### Metadata Configuration

#### 23.1 Introduction

This chapter describes system configuration data for network-based telemetry systems in a common fashion, and provides a language for describing the configuration of all of the components in a telemetry system, as well as their logical and physical interrelationships. The language is intended to be expressive enough to describe a wide variety of systems: large and small, simple and complex, from the low-level transducer-to-measurement association for an acquisition card on a data acquisition unit up to network topology of multiple test mission networks.

This chapter defines the Metadata Description Language (MDL), which has a syntax that defines vocabulary and sentence structure, while the MDL semantics provide meaning. Using the MDL syntax and semantics, MDL instance documents can be created to describe telemetry systems. The descriptions may be used in various ways: to configure components, to predict the performance of the network, or to capture requirements for the telemetry system. Additionally, the MDL provides a common exchange language that facilitates the interchange of configuration information between telemetry system components.

#### 23.2 Metadata Description Language

The MDL is described only as an eXtensible Markup Language (XML) schema. The MDL XML language schema consists of an XML schema document (XSD) file that defines the structure of valid MDL instance documents. Additionally, an automatic transformation process is applied to the schema in order to create a graphical depiction of the schema in Hyper Text Markup Language (HTML) format. The schema and HTML depiction are available [here](#).

**NOTE**

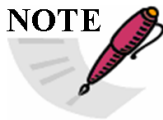

The MDL XML-based schema is not intended to be read in a plain text fashion. The HTML graphical depiction is provided as an aid for those desiring to read the schema.

##### 23.2.1 MDL Schema Concepts

The MDL schema defines a syntax, which includes a vocabulary, a set of types, and the rules for how an MDL instance document shall be structured. The syntax definition is realized using the XML Schema standard, which is maintained by the World Wide Web Consortium (W3C -- [www.w3.org](http://www.w3.org)).

**NOTE**



The MDL builds upon the existing schema standard of the W3C. Readers unfamiliar with W3C schemas as a whole are encouraged to study basic concepts from the W3C prior to attempting to understand the MDL.

Constraints as defined by the W3C are a part of the MDL schema. In the MDL schema implementation, these constraints are distributed between statements that are syntax-related (encoded and enforced by the schema) and statements that are semantic-related (additional rules that are levied and provide meaning). The syntax of the language is enforced using W3C XML Schema constraints.

When possible, XML mechanisms are used to enforce semantic constraints. In cases not supported cleanly by XML, text has been added directly to the MDL schema documentation. In such cases, the text will typically include the keyword “shall”. The phrase “the value of the **Name** element of the **Measurement** element shall be unique” is one such example.

 <p><b>NOTE</b></p>	<p>Not all constraints that must be met in order for an MDL file to be valid for configuration can be expressed by W3C constraints. Plain text is used in the schema to describe such cases. Additionally, applications consuming or generating MDL instance documents are expected to assure that the files are valid.</p>
--	---

### 23.2.1.1 Conditional elements in the MDL Schema Definition File

The MDL schema is a system-level description. Not all components require every element to properly configure. In such cases, these elements are conditional. The documentation specifies when the conditional elements shall be present and processed. Components not specifically called out in documentation of conditional elements shall not fail to configure if the particular conditional element is not present.

 <p><b>NOTE</b></p>	<p>Use of “conditional” over “optional” is an intentional style chosen for the MDL grammar. Conditional is preferred in order to remove ambiguity concerning grammar elements that must be considered by devices exchanging MDL files that are to be used for configuration.</p>
--	--

### 23.2.1.2 Naming conventions in the MDL Schema Definition File

In the MDL schema definition file, MDL elements and attributes appear as instances of defined **xsd:complexType** and **xsd:simpleType** elements. Each declaration of these MDL-specific elements will specify a **name** attribute that is assigned a string that contains the name of the MDL element being described followed by a string suffix of “Type” or “Enum”. For example, the top-level element of the MDL schema is the **MDLRoot** element. In the MDL schema definition file, this element appears as an instance of an **xsd:complexType** element with a **name** attribute of “MDLRootType”. These **name** attribute strings that correspond to the defined MDL elements only appear in the MDL schema definition file.

### 23.2.1.3 Indexing policies

Numerical indices present in an MDL instance document are recommended to count starting at 1 and to increment by one (i.e., 1, 2, 3, 4,...).

### 23.2.1.4 Uniqueness of ID attributes

Values of **ID** attributes of any element within an MDL instance document shall be unique. The **ID** attributes are used to implement references.

### 23.2.1.5 Extending MDL with supplementary XML-based standards

The use of other XML-based standards (i.e., other schemas) in conjunction with the MDL schema is permitted. Potentially, the use of these external standards through their accompanying schemas leverages existing knowledge to describe concepts and domains beyond those in the MDL. The MDL does not explicitly constrain the available mechanisms to use external

standards; however, the linking of external schemas to the MDL schema shall not result in the modification of the MDL schema.

#### 23.2.1.6 Usage of Telemetry Attributes Transfer Standard in MDL

The MDL schema requires the **tmatsP:PCMFormatAttributesType** to describe pulse code modulation (PCM) measurements, and it is imported directly from the Telemetry Attributes Transfer Standard (TMATS) schema. The TMATS schema files are included with the MDL schema for convenience, and are also available in [Chapter 9](#).

#### 23.2.1.7 Usage of GenericParameter Element

The **GenericParameter** element allows the description of additional information outside the scope of the MDL, and may also be used to document decisions made to arrive at a vendor-specific configuration. **GenericParameter** shall be used to extend the MDL grammar when it cannot support those required concepts natively, or as a key so that vendor tools can arrive at the same configuration as in a previous run.

#### 23.2.1.8 Recommended Best Practices

[Appendix 23-C](#) contains a table of recommended best practices to further enhance interoperability.

#### 23.2.2 MDL Global Element Glossary

The MDL schema contains a large number of **xsd:documentation** elements that describe the intent, purpose, or usage of the elements in MDL. These embedded annotations collectively form the global element glossary for the MDL schema. The glossary can be viewed [here](#) (the MDL Schema Documentation.html file located in the compressed folder this link opens). It is automatically produced from the schema file by way of an eXtensible Stylesheet Language stylesheet, which renders the documentation as HTML.

This page intentionally left blank.

## **APPENDIX 23-A**

### **MDL Examples**

Example MDL files (XML instance documents) and associated documentation are [here](#). As with most grammars, it is expected that the examples will be very useful in clarifying the expected use of MDL; however, the documentation of the schema takes precedence over concepts or details that may be inferred through the examples.

This page intentionally left blank.



## APPENDIX 23-B

### MDL Relationships to Chapters

The MDL is used to describe system configuration data for network-based telemetry systems; therefore, it includes elements to describe the concepts presented across Chapters 22 through 28. [Table B-1](#) provides a mapping of the relevant top-level MDL elements and their relationships to these chapters.

<b>Table B-1. MDL Mapping to RCC 106 Chapters</b>		
<b>MDLRoot Element</b>	<b>Relationship</b>	<b>RCC 106 Chapter</b>
TestMissions	Data Protocol	22: Network-Based Protocol Suite
	Management	26: TmNSDataMessage Transfer Protocol
MeasurementDomains	Message Internals	24: Message Formats
NetworkDomains	Network Shape	22: Network-Based Protocol Suite
	Network Use	25: Management Resources
	Network Management	26: TmNSDataMessage Transfer Protocol
RANConfigs	Radio Links	27: RF Network Access Layer
	Radio Management	28: RF Network Management
DSCPTable	Quality of Service	22: Network-Based Protocol Suite

Additionally, the spreadsheet inside the compressed folder linked [here](#) provides a detailed mapping of all MDL elements to Chapter 22 through 28.

This page intentionally left blank.

## APPENDIX 23-C

### MDL Recommended Best Practices

[Table C-1](#) provides recommended best practices for creating MDL instance documents that will enhance interoperability.

<b>Table C-1. MDL Recommended Best Practices</b>		
Scenario	MDL Syntax/Semantics	Related Scenarios
1. Measurement Name Scoping for External Usage	<p>Any of the following can be used to identify a measurement. External tool representation examples:</p> <ul style="list-style-type: none"> <li>• Multiple Test Article (TA), Multiple Transport Case                             <ul style="list-style-type: none"> <li>○ TA/TRANSPORT/MEASUREMENT (e.g., Weapon1/PCM1/Airspeed)</li> </ul> </li> <li>• Single TA, Multiple Transport Case                             <ul style="list-style-type: none"> <li>○ */TRANSPORT/MEASUREMENT (e.g., */PCM1/Airspeed)</li> </ul> </li> <li>• Multiple TA, Single Transport Case                             <ul style="list-style-type: none"> <li>○ TA/*/MEASUREMENT (e.g., Weapon1/*/Airspeed)</li> </ul> </li> <li>• Single TA, Single Transport Case                             <ul style="list-style-type: none"> <li>○ */*/MEASUREMENT (e.g., */*/Airspeed)</li> </ul> </li> </ul> <p>The recommended delimiter is the forward slash (/) character. When fields are not required to uniquely identify a measurement, the recommended wildcard is the asterisk (*) character. Measurement names should avoid embedded blanks or special characters other than <code>_</code> and <code>-</code>.</p>	None
2. Choosing the Correct DataProcessing Function Type	<p>If a <b>DataProcessing Function</b> can be represented by a <b>LookupTable</b> element or a <b>Polynomial</b> element then these <b>Function</b> types should be used instead of the generic <b>Algorithm</b> element.</p> <p>Polynomial example:</p> <pre> &lt;Function&gt;   &lt;Name&gt;Polynomial Example&lt;/Name&gt;   &lt;Description&gt;(5x**2 + 6x + 7) / (2.5x**3 + 3x*1.64)&lt;/Description&gt;   &lt;InputCount&gt;1&lt;/InputCount&gt;   &lt;UpdateFrequency&gt;IfAny&lt;/UpdateFrequency&gt;   &lt;Polynomial&gt;     &lt;Numerator&gt;       &lt;Term&gt;         &lt;Coefficient&gt;5&lt;/Coefficient&gt;         &lt;Exponent&gt;2&lt;/Exponent&gt;       &lt;/Term&gt;       &lt;Term&gt;         &lt;Coefficient&gt;6&lt;/Coefficient&gt; </pre>	3. Specifying Points in a LookupTable

**Table C-1. MDL Recommended Best Practices**

Scenario	MDL Syntax/Semantics	Related Scenarios
	<pre>                 &lt;Exponent&gt;1&lt;/Exponent&gt;             &lt;/Term&gt;         &lt;/Term&gt;         &lt;Term&gt;             &lt;Coefficient&gt;7&lt;/Coefficient&gt;             &lt;Exponent&gt;0&lt;/Exponent&gt;         &lt;/Term&gt;     &lt;/Numerator&gt;     &lt;Denominator&gt;         &lt;Term&gt;             &lt;Coefficient&gt;2.5&lt;/Coefficient&gt;             &lt;Exponent&gt;3&lt;/Exponent&gt;         &lt;/Term&gt;         &lt;Term&gt;             &lt;Coefficient&gt;3&lt;/Coefficient&gt;             &lt;Exponent&gt;1.64&lt;/Exponent&gt;         &lt;/Term&gt;     &lt;/Denominator&gt; &lt;/Polynomial&gt; &lt;/Function&gt;                     </pre>	
<p>3. Specifying Points in a LookupTable</p>	<p>When defining a <b>LookupTable</b> in a <b>DataProcessing Function</b> the complete set of points should be provided, including +/-Inf. If all points are not provided, then the <b>LookupTable</b> output is undefined for those input points.</p> <p><b>LookupTable</b> example:</p> <pre> &lt;Function&gt;     &lt;Name&gt;LookupTable Example&lt;/Name&gt;     &lt;Description&gt;Example showing a lookup table&lt;/Description&gt;     &lt;InputCount&gt;1&lt;/InputCount&gt;     &lt;UpdateFrequency&gt;IfAny&lt;/UpdateFrequency&gt;     &lt;LookupTable&gt;         &lt;LookupTableEntry&gt;  &lt;InputValue&gt;NegativeInfinity&lt;/InputValue&gt;         &lt;OutputValue&gt;0.0&lt;/OutputValue&gt;     &lt;/LookupTableEntry&gt;     &lt;LookupTableEntry&gt;         &lt;InputValue&gt;0&lt;/InputValue&gt;         &lt;OutputValue&gt;0.0&lt;/OutputValue&gt;     &lt;/LookupTableEntry&gt;     &lt;LookupTableEntry&gt;         &lt;InputValue&gt;1&lt;/InputValue&gt;         &lt;OutputValue&gt;1.0&lt;/OutputValue&gt;     &lt;/LookupTableEntry&gt;     &lt;LookupTableEntry&gt;         &lt;InputValue&gt;2&lt;/InputValue&gt;                     </pre>	<p>None</p>

**Table C-1. MDL Recommended Best Practices**

Scenario	MDL Syntax/Semantics	Related Scenarios
	<pre>                 &lt;OutputValue&gt;5.0&lt;/OutputValue&gt;             &lt;/LookupTableEntry&gt;         &lt;/LookupTableEntry&gt;          &lt;InputValue&gt;PositiveInfinity&lt;/InputValue&gt;         &lt;OutputValue&gt;6.0&lt;/OutputValue&gt;         &lt;/LookupTableEntry&gt;     &lt;/LookupTable&gt; &lt;/Function&gt;                     </pre>	
<p>4. Using MeasurementTimeRefs in Packages</p>	<p>Packages should only contain one instance of time (a single <b>MeasurementTimeRef</b>) per set of measurements taken at that time.</p> <p><b>MeasurementTimeRef</b> example:</p> <pre> &lt;DataMaps&gt;   &lt;DataWordToFieldMap&gt;     &lt;DataWord&gt;       &lt;Name&gt;Measurement 1&lt;/Name&gt;       &lt;Description&gt;Simultaneously sampled measurement&lt;/Description&gt;       &lt;DataWordWidth&gt;         &lt;Value&gt;16&lt;/Value&gt;         &lt;BaseUnit&gt;Bit&lt;/BaseUnit&gt;       &lt;/DataWordWidth&gt;       &lt;MeasurementRef IDREF="Meas1"/&gt;       &lt;Syllables&gt;         &lt;Syllable&gt;           &lt;Name&gt;Measurement 1 Syllable&lt;/Name&gt;           &lt;/Syllable&gt;         &lt;/Syllables&gt;       &lt;/DataWord&gt;       &lt;DataStructureFieldRef IDREF="Package1_Field1"/&gt;     &lt;/DataWordToFieldMap&gt;     &lt;DataWordToFieldMap&gt;       &lt;DataWord&gt;         &lt;Name&gt;Measurement 2&lt;/Name&gt;         &lt;Description&gt;Simultaneously sampled measurement&lt;/Description&gt;         &lt;DataWordWidth&gt;           &lt;Value&gt;16&lt;/Value&gt;           &lt;BaseUnit&gt;Bit&lt;/BaseUnit&gt;         &lt;/DataWordWidth&gt;         &lt;MeasurementRef IDREF="Meas2"/&gt;                     </pre>	<p>None</p>

**Table C-1. MDL Recommended Best Practices**

Scenario	MDL Syntax/Semantics	Related Scenarios
	<pre>                 &lt;Syllables&gt;                     &lt;Syllable&gt;                         &lt;Name&gt;Measurement 2 Syllable&lt;/Name&gt;                     &lt;/Syllable&gt;                 &lt;/Syllables&gt;             &lt;/DataWord&gt;             &lt;DataStructureFieldRef IDREF="Package1_Field2"/&gt;  &lt;TimeOrder&gt;IncreasingTemporal&lt;/TimeOrder&gt; &lt;/DataWordToFieldMap&gt; &lt;DataWordToFieldMap&gt;     &lt;DataWord&gt;         &lt;Name&gt;Time Measurement&lt;/Name&gt;         &lt;Description&gt;Time that the simultaneously sampled measurements were taken&lt;/Description&gt;         &lt;DataWordWidth&gt;             &lt;Value&gt;16&lt;/Value&gt;             &lt;BaseUnit&gt;Bit&lt;/BaseUnit&gt;         &lt;/DataWordWidth&gt;         &lt;MeasurementRef IDREF="Time"/&gt;         &lt;Syllables&gt;             &lt;Syllable&gt;                 &lt;Name&gt;Time Measurement Syllable&lt;/Name&gt;             &lt;/Syllable&gt;         &lt;/Syllables&gt;     &lt;/DataWord&gt;     &lt;DataStructureFieldRef IDREF="Package1_Field3"/&gt;  &lt;TimeOrder&gt;IncreasingTemporal&lt;/TimeOrder&gt; &lt;/DataWordToFieldMap&gt; &lt;/DataMaps&gt; </pre> <p>Note: If repeating fields are required, then packages without headers can be used to create the same resulting output as one defined by repeating fields. To accomplish this, the first package would use standard package headers and contain a measurement value and <b>MeasurementTimeRef</b>. Subsequent repeating packages would not use a header and contain the repeated measurement values each with its own <b>MeasurementTimeRef</b>.</p>	

\*\*\*\* END OF CHAPTER 23 \*\*\*\*

## CHAPTER 24

### Message Formats

<b>Acronyms</b> .....	<b>24-iii</b>
<b>Chapter 24. Message Formats</b> .....	<b>24-1</b>
<b>24.1 Type-Length Value Structure</b> .....	<b>24-1</b>
<b>24.2 TmNSMessage</b> .....	<b>24-1</b>
24.2.1 TmNSMessageHeader Structure.....	24-2
24.2.2 TmNSMessagePayload Structure.....	24-7
<b>24.3 Radio Frequency (RF) Network Message</b> .....	<b>24-10</b>
24.3.1 RF Network Message Header Structure.....	24-10
24.3.2 RF Network Message Payload Structure.....	24-11
<b>24.4 TSS Messages</b> .....	<b>24-17</b>
24.4.1 TSS Initialization Message Structure.....	24-17
24.4.2 TSS Data Message Structure.....	24-18

### List of Figures

Figure 24-1. Type-Length-Value Structure.....	24-1
Figure 24-2. Multi-Value TLF Structure.....	24-1
Figure 24-3. TmNSMessage Structure.....	24-2
Figure 24-4. TmNSMessageHeader Structure.....	24-3
Figure 24-5. Option-Kind Message Structure.....	24-5
Figure 24-6. TmNSDataMessagePayload Structure.....	24-7
Figure 24-7. Package Structure Containing PackageHeader and PackagePayload.....	24-8
Figure 24-8. Standard PackageHeader Field Structure.....	24-9
Figure 24-9. RF Network Message Structure.....	24-10
Figure 24-10. RF Network Message Header Structure.....	24-11
Figure 24-11. TSS Initialization Message Structure.....	24-18
Figure 24-12. TSS Data Message Structure.....	24-19
Figure 24-13. Algorithm For CRC Calculation (ANSI C Grammar).....	24-20

### List of Tables

Table 24-1. ApplicationDefinedFields “option-kind” List.....	24-6
Table 24-2. RF Network Message TLVs.....	24-11
Table 24-3. TxOp Assignment TLV.....	24-12
Table 24-4. TxOp ID Acknowledgement Report TLV.....	24-13
Table 24-5. MAC Queue Status Report TLV.....	24-13
Table 24-6. Heartbeat TLV.....	24-14
Table 24-7. Link Metric TLV.....	24-14

Table 24-8.	TE Queue Status Report TLV.....	24-15
Table 24-9.	Link Transmit Statistics Report TLV .....	24-17
Table 24-10.	TSS Initialization Message Codes .....	24-18



## Acronyms

CINR	Carrier to Interference + Noise Ratio
CRC	cyclic redundancy check
DSCP	Diffserv Code Point
GHz	gigahertz
IOCTL	input/output control
IP	Internet Protocol
kHz	kilohertz
MAC	media access control
MDL	Metadata Description Language
RF	radio frequency
RFNM	radio frequency network message
RSSI	received signal strength indicator
TCP	Transmission Control Protocol
TE	Traffic Engineering
TAI	International Atomic Time
TLV	Type-Length-Value
TmNS	Telemetry Network Standard
TxOp	transmission opportunity

This page intentionally left blank.

## CHAPTER 24

### Message Formats

Application messages are message structures used to pass information between applications using an application layer protocol. The bit numbering, bit ordering, and byte ordering conventions used in this chapter are described in [Chapter 21](#) Appendix 21-B.

#### 24.1 Type-Length Value Structure

The Type-Length-Value (TLV) message structure is depicted in [Figure 24-1](#).

TYPE	LENGTH	VALUE
------	--------	-------

Figure 24-1. Type-Length-Value Structure

The TLV field descriptions are provided below.

<u>Field Name</u>	<u>Field Length</u>	<u>Field Description</u>
<b>Type</b>	Fixed	Type of the TLV message, encoded as a binary value
<b>Length</b>	Fixed	Length, typically in bytes, of the entire TLV message (including Type and Length fields)
<b>Value</b>	Length = Length field value – (the length of the Type field + length of the Length field)	Data portion of the TLV message

For each defined TLV sequence, the Type and Length field sizes are fixed, a specific set of Types are defined, and each Value field may encode one or more pieces of information, as depicted in [Figure 24-2](#).

TYPE	LENGTH	VALUE
Type	Length	Value1   Value2   ...   ValueN

Figure 24-2. Multi-Value TLF Structure

 <b>NOTE</b>	The following figure represents an ASCII message “ABCD” (0x41, 0x42, 0x43, 0x44) with a Type of 0xA97. The Type field is two bytes long and the Length field is one byte long.							
		Type		Length	Value			
	Byte Number	1	2	3	4	5	6	7
Data	0x0A	0x97	0x07	0x41	0x42	0x43	0x44	

#### 24.2 TmNSMessage

A *TmNSMessage* shall contain a *TmNSMessageHeader* and may contain a *TmNSMessagePayload* as shown in [Figure 24-3](#).

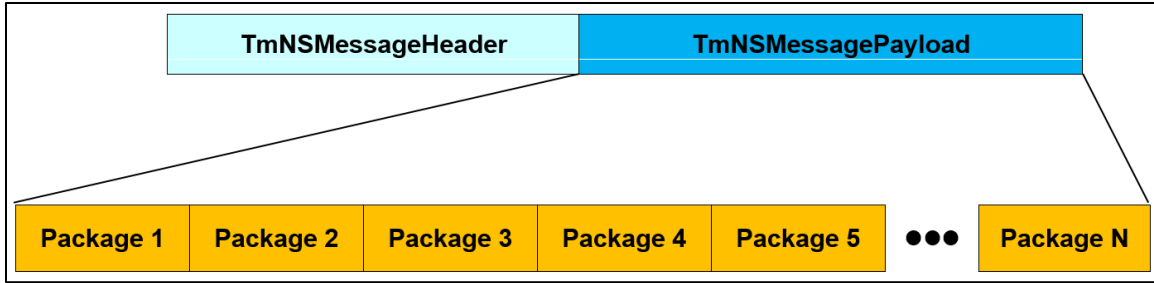



Figure 24-3. TmNSMessage Structure

All *TmNSMessageHeader* and *PackageHeader* fields in the *TmNSMessagePayload* shall use big-endian ordering as specified in [Chapter 21](#) Section B.3 and the bit numbering specified in [Chapter 21](#) Section B.2. *TmNSMessagePayload* fields (e.g., *PackagePayloads* fields described in MDL instance documents) are often based on acquisition data from non-Internet Protocol (IP)-network systems and, therefore, are not required to comply with the big-endian convention.

 <p><b>NOTE</b></p>	<p>The IP specification defines standard network byte order as big-endian for all numeric values in the IP packet headers. This standard maintains consistency with the IP specification by defining all numeric values in <i>TmNSMessageHeader</i> and <i>PackageHeader</i> fields of the <i>TmNSMessage</i> as following network byte order (i.e., big-endian).</p>
--	---

#### 24.2.1 TmNSMessageHeader Structure

The *TmNSMessageHeader* shall contain the following fields and associated bit-widths as outlined in [Figure 24-4](#).

- MessageVersion – 4 bits
- OptionWordCount – 4 bits
- Reserved – 4 bits
- MessageType – 4 bits
- MessageFlags – 16 bits
- MessageDefinitionID – 32 bits
- MessageDefinitionSequenceNumber – 32 bits
- MessageLength – 32 bits
- MessageTimestamp – 64 bits
- ApplicationDefinedFields – variable (OptionWordCount \* 32 bits)

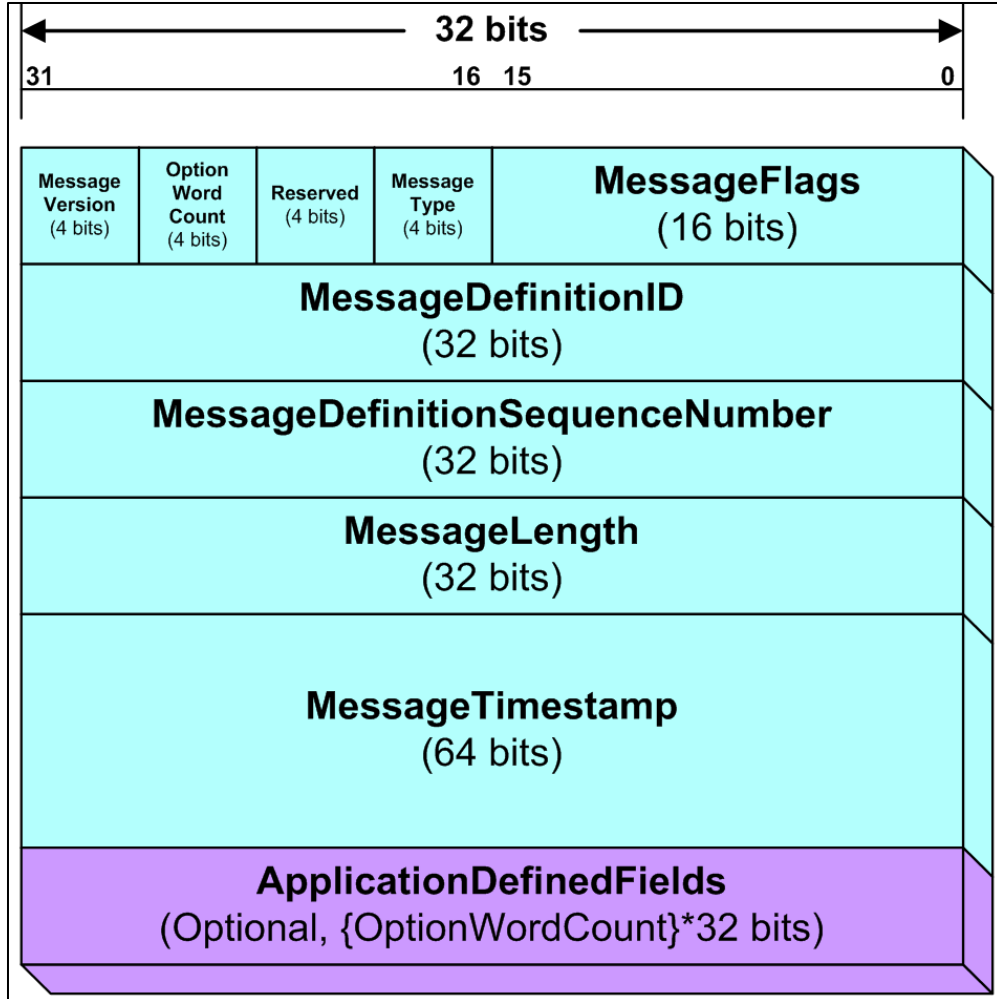

Figure 24-4. TmNSMessageHeader Structure

24.2.1.1 MessageVersion Field

The **MessageVersion** field specifies the version of the *TmNSMessage* protocol. This document defines Message Version 1 (i.e., 4'b0001)

24.2.1.2 OptionWordCount Field

The **OptionWordCount** field shall specify the number of 32-bit words in the **ApplicationDefinedFields**.

24.2.1.3 Reserved Field

This field is reserved for future use. All bits shall be set to zero (4'b0000) on transmission; ignored on reception.

24.2.1.4 MessageType Field

The **MessageType** field specifies the type of the *TmNSMessage*. This document defines the following message types:

- 4'b0000 – TmNSDataMessage

#### 24.2.1.5 MessageFlags Field

The **MessageFlags** field shall provide indicators of *TmNSMessage* options and/or conditions. Using the bit-numbering convention specified in [Chapter 21](#) Appendix 21-B, the bits are defined as follows.

- **Reserved for Future Use** bits (bits 15-8). All bits shall be set to zero (8'h00) on transmission; ignored on reception.
- StandardPackageHeaderFlag bit (bit 7):
  - 1'b0 – At least one *Package* uses a *PackageHeader* completely described in an MDL instance document or at least one *Package* does not contain a *PackageHeader*
  - 1'b1 – All *Packages* use the Standard *PackageHeaders* (see Subsection [24.2.2.1.1](#))

For *TmNSMessages* that do not contain *Packages*, this bit shall be set to 1'b0.

- PlaybackDataFlag bit (bit 6):
  - 1'b0 – Live data (from source)
  - 1'b1 – Playback data
- MessageFragmentationFlags bits (bits 5-4):
  - 2'b00 – Complete *TmNSMessage*
  - 2'b01 – *TmNSMessage* with the first fragment
  - 2'b10 – *TmNSMessage* with a middle fragment
  - 2'b11 – *TmNSMessage* with the last fragment
 See [Chapter 26](#) Subsection 26.5.3 for more details.
- DataSourceAcquiredDataFlag bit (bit 3):
  - 1'b0 – Acquired data in this *TmNSMessage*
  - 1'b1 – Simulated data in this *TmNSMessage*
- DataSourceTimeLockFlag bit (bit 2):
  - 1'b0 – *DataSource* time locked to IEEE 1588 master clock
  - 1'b1 – *DataSource* time NOT locked to IEEE 1588 master clock
- DataSourceHealthFlag bit (bit 1):
  - 1'b0 – No error in the portion of the *DataSource* generating this *TmNSMessage*
  - 1'b1 – Error in the portion of the *DataSource* generating this *TmNSMessage*
- EndOfDataFlag bit (bit 0)
  - 1'b0 – Normal *TmNSMessage*
  - 1'b1 – End-of-data *TmNSMessage*
 See [Chapter 26](#) Subsection 26.4.2.2 for usage details of this bit.

See [Chapter 26](#) Subsection 26.5.4 for rules governing the merging of the **MessageFlags** field from multiple *TmNSDataMessages*.

#### 24.2.1.6 MessageDefinitionID Field

The *MessageDefinitionID* field shall contain the *MessageDefinitionID* of the *TmNSMessage*.

24.2.1.7 MessageDefinitionSequenceNumber Field

The **MessageDefinitionSequenceNumber** field shall provide a non-negative integer that increments by one for each *TmNSMessage* instance in a sequence of *TmNSMessages*.

See [Chapter 26](#) Subsection 26.5.1 for additional **MessageDefinitionSequenceNumber** rules.

24.2.1.8 MessageLength Field

The **MessageLength** field shall provide the length (in bytes) of the *TmNSMessage* (or fragment), including the *TmNSMessageHeader* and *TmNSMessagePayload* (including padding).

Padding shall be used if a *TmNSMessage* does not fall on a 32-bit boundary.

24.2.1.9 MessageTimestamp Field (64 bits)

The **MessageTimestamp** field shall provide the message base time (in seconds and nanoseconds). The field shall use the lower 64 bits of the IEEE 1588-2008 specified time structure.

See [Chapter 26](#) Subsection 26.5.2 for additional **MessageTimestamp** rules.

24.2.1.10 ApplicationDefinedFields Field (OptionWordCount\*32 bits)

**ApplicationDefinedFields** provide for optional header fields identified by the **option-kind** field (similar to Transmission Control Protocol [TCP] Options). [Figure 24-5](#) shows **ApplicationDefinedFields**.

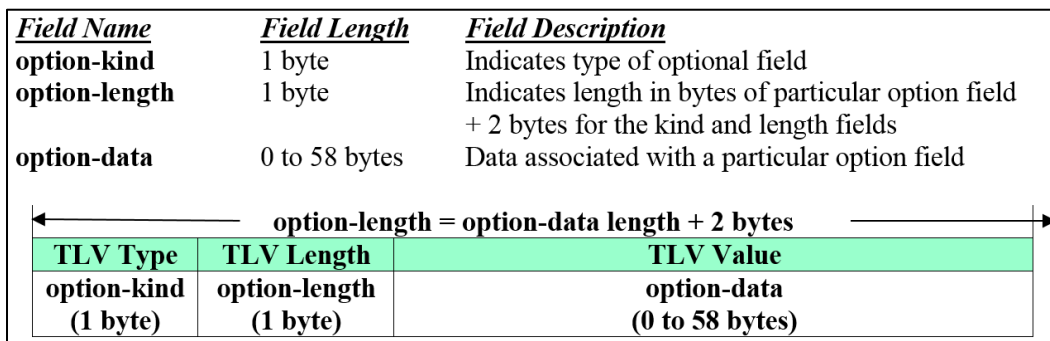

Figure 24-5. Option-Kind Message Structure

Multiple **option-kind** fields may be included in the **ApplicationDefinedFields** as long as the total **ApplicationDefinedFields** size does not exceed 60 bytes. The **ApplicationDefinedFields** shall fall on a 32-bit boundary (i.e., length shall be an integer number of 32-bit words). For **option-kind** values between 8'h00 – 8'h7F inclusive, neither the **option-length** nor **option-data** fields are included resulting in a length of one byte. For **option-kind** values between 8'h80 – 8'hFF inclusive, both the **option-length** and **option-data** fields are included, resulting in an **option-data** length of **option-length – 2 bytes**. [Table 24-1](#) defines each supported **option-kind** value along with their corresponding **option-length** and **option-data** values.

<b>Table 24-1. ApplicationDefinedFields “option-kind” List</b>				
<b>option-kind</b>	<b>Type</b>	<b>option-length</b>	<b>option-data</b>	<b>Comment</b>
8’h00	End of Options	N/A	N/A	Also used for padding to 32-bit boundary
8’h01	No Operation (NOP)	N/A	N/A	Allows individual options to be 32-bit aligned if needed (not required)
8’h02 – 8’h3F		N/A	N/A	Reserved for future allocation
8’h40 – 8’h7F		N/A	N/A	Reserved for implementation-specific or experimental use
8’h80				Reserved for future allocation
8’h81				Reserved for future allocation
8’h82	<i>DataSource Configuration</i>	3-32	An implementation-specific structure of configuration for the <i>DataSource</i> generating this <i>TmNSDataMessage</i>	
8’h83	<i>DataSource Error</i>	3-32	An implementation-specific structure of an error condition for the <i>DataSource</i> generating this <i>TmNSDataMessage</i>	
8’h84				Reserved for future allocation
8’h85	Destination Address	6 18	IPv4 address (unicast, multicast, broadcast) IPv6 address (unicast, multicast, broadcast)	
8’h86	Fragment Byte Offset	6	Byte offset of current fragment (32-bit length)	
8’h87	Package Count	6	Count of number of <i>Packages</i> in this message	
8’h88	Ingress Timestamp	8	Timestamp of when a message was most recently received. Timestamp format is 32-bit International Atomic Time (TAI) seconds field followed by 32-bit nanoseconds field.	This is the system time when the receiving entity received this message.
8’h89	Egress Timestamp	8	Timestamp of when a message was most recently transmitted. Timestamp	This is the system time when the transmitting entity sent the message



Table 24-1. ApplicationDefinedFields “option-kind” List				
option-kind	Type	option-length	option-data	Comment
			format is 32-bit TAI seconds field followed by 32-bit nanoseconds field.	(e.g., local system time of recorder when it sends a message it received previously).
8’h8A –8’hBF				Reserved for future allocation
8’hC0 – 8’hFF				Reserved for implementation-specific or experimental use

**NOTE**  The use of **ApplicationDefinedFields’ option-kind** value in the “implementation-specific or experimental use” range is permitted but does not ensure interoperability.

24.2.2 TmNSMessagePayload Structure

The *TmNSMessagePayload* is optional. If present, the *TmNSMessagePayload* shall include one or more *Packages* as illustrated in [Figure 24-6](#).

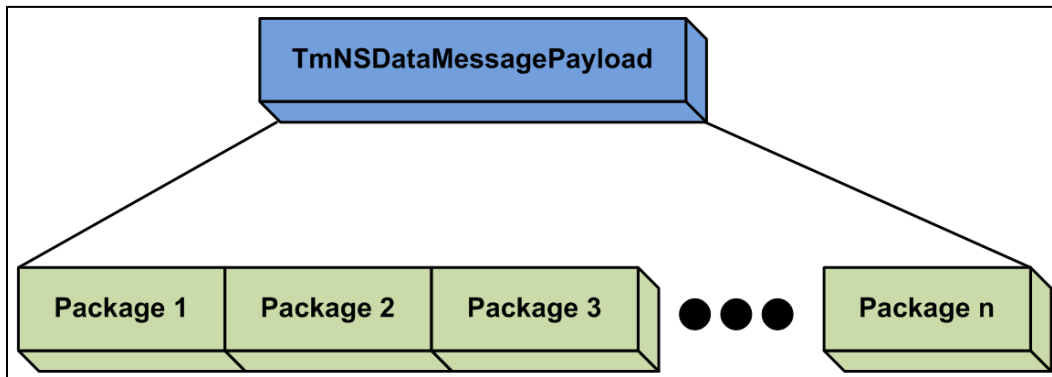



Figure 24-6. TmNSDataMessagePayload Structure

**NOTE**  The *MessageDefinitionID* specified in the *TmNSDataMessage* header serves as a reference to the structure, content, and ordering of *Package(s)* in the *TmNSDataMessage* payload. For details on how this information is described within an MDL instance document, refer to [Chapter 23](#).

Each *Package* shall include either a *PackageHeader*, a *PackagePayload*, or both. The case where both a *PackageHeader* and *PackagePayload* are present is illustrated in [Figure 24-7](#).

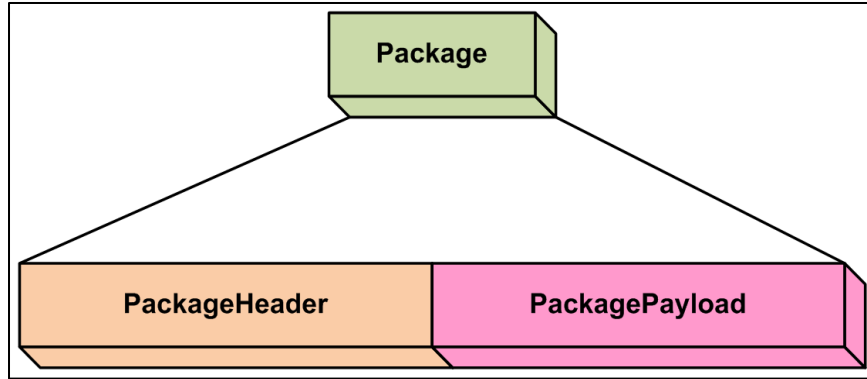

Figure 24-7. Package Structure Containing PackageHeader and PackagePayload

#### 24.2.2.1 Package Header

The *PackageHeader* contains fields that describe the *PackagePayload*. When using a *PackageHeader*, *TmNSDataMessages* shall use either the standard *PackageHeader* or a *PackageHeader* completely described in an MDL instance document.

##### 24.2.2.1.1 Standard PackageHeader

The standard *PackageHeader* shall contain the following fields.

- PackageDefinitionID – 32 bits
- PackageLength – 16 bits
- Reserved – 8 bits
- PackageStatusFlags – 8 bits
- PackageTimeDelta – 32 bits

[Figure 24-8](#) illustrates the standard *PackageHeader*. When using standard *PackageHeaders*, the *Package* shall start and end on 32-bit boundaries.

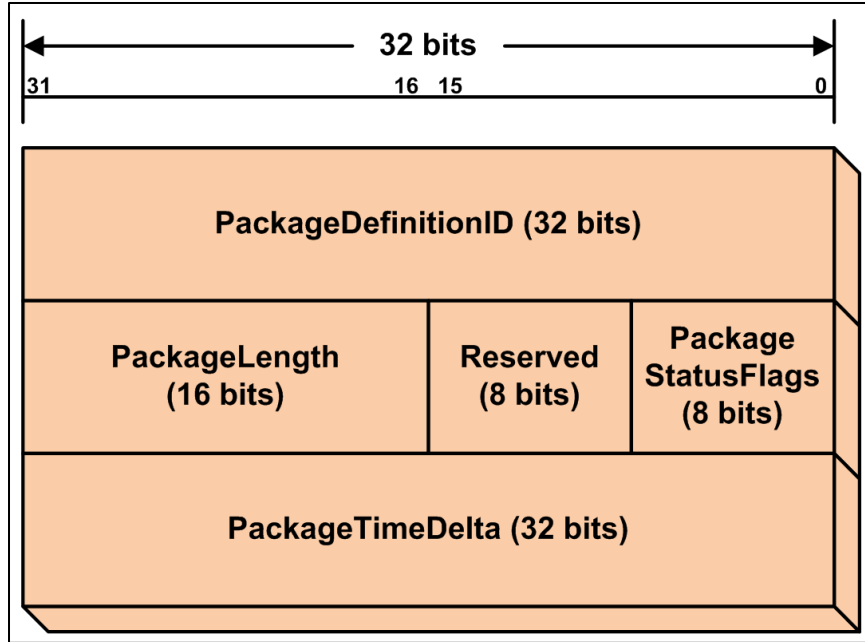

Figure 24-8. Standard PackageHeader Field Structure

#### 24.2.2.1.1.1 *PackageDefinitionID Field*

The **PackageDefinitionID** field shall contain the *PackageDefinitionID* of the *Package*.

#### 24.2.2.1.1.2 *PackageLength Field*

The **PackageLength** field shall specify the length, in bytes, of the entire *Package* (including *PackageHeader* and *PackagePayload*, but not including padding) to identify the end of bytes containing *MeasurementData* in the *Package*.

Padding shall be used to ensure a *Package* with a standard *PackageHeader* starts and ends on a 32-bit boundary.

#### 24.2.2.1.1.3 *Reserved*

All bits shall be set to zero (8'h00) on transmission; ignored on reception.

#### 24.2.2.1.1.4 *PackageStatusFlags Field*

The **PackageStatusFlags** field may provide indications on specific *MeasurementData* in a *Package* and/or error indications (e.g., parity, out of range, wrong frame size, etc.) of the *DataSource* producing the *MeasurementData*. These flags can be described by an MDL instance document. Each **PackageStatusFlags**' 1'b0 value shall be interpreted as a "no error" condition for that particular condition. Each **PackageStatusFlags** bit not described in an MDL instance document shall be set to 1'b0.

#### 24.2.2.1.1.5 *PackageTimeDelta Field*

The **PackageTimeDelta** field shall provide the *Package* base time relative to the **MessageTimestamp** field in the *TmNSDataMessageHeader*. The value in the field shall be a non-negative integer that represents nanosecond resolution in the range of 0 to  $2^{32} - 1$ .

#### 24.2.2.1.2 MDL-Described PackageHeader

A custom *PackageHeader* shall be used if the standard *PackageHeader* is not used for the *Package*. Custom *PackageHeaders* shall be completely described within the MDL instance document that contains the *Package* description.

#### 24.2.2.2 Package Time Measurement Scoping Rules

The Telemetry Network Standard (TmNS) schema in [Chapter 23](#) defines the *MeasurementTimeRef* element, which is a measurement that is associated with another measurement. There shall be no *MeasurementTimeRef* elements that reference outside a single package instance within a single message instance.

### 24.3 Radio Frequency (RF) Network Message

There is one general structure for all RF network messages. The structure consists of a common RF network message header followed by the RF network message payload. The payload consists of one or more TLVs.

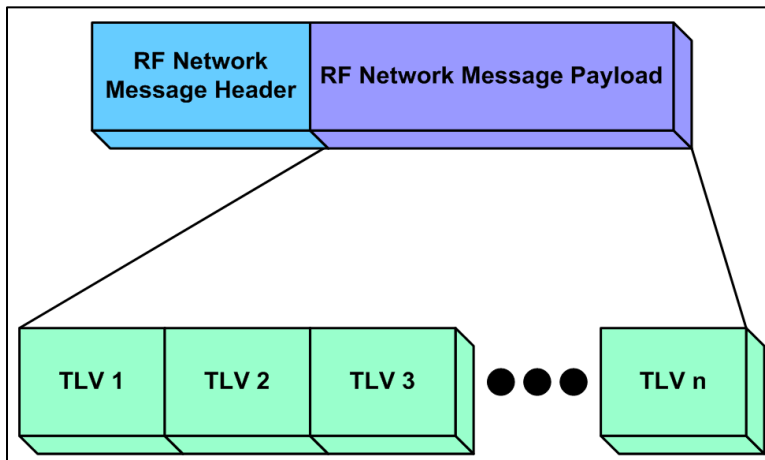

Figure 24-9. RF Network Message Structure

All fields in an RF network message shall use big-endian ordering as specified in [Chapter 21](#) Appendix 21-B.

#### 24.3.1 RF Network Message Header Structure

An RF network message header shall contain the following fields shown in [Figure 24-10](#):

- Message Length – 16 bits
- Destination RF Media Access Control (MAC) address – 16 bits
- Source RF MAC Address - 16 bits
- Message Sequence Number – 32 bits

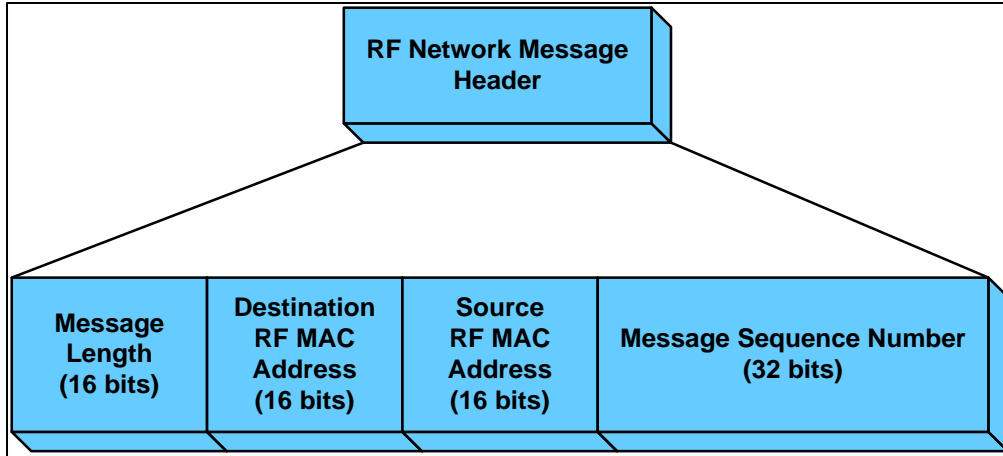

Figure 24-10. RF Network Message Header Structure

24.3.1.1 Message Length

This field indicates the remaining length in bytes of the RF network message. The size of the RF network message is the size of the Message Length field plus the value contained therein.

24.3.1.2 Destination RF MAC Address

This field contains the destination RF MAC address. The combination of the destination RF MAC address and the source RF MAC address identify a particular link for which the RF network message is associated

24.3.1.3 Source RF MAC Address

This field contains the source RF MAC address.

24.3.1.4 Message Sequence Number

The Message Sequence Number serves as an identifier of a particular RF network message. The sequence number shall be associated with the destination RF MAC address and source RF MAC address pair contained in the RF network message header. Entities that send RF network messages shall increment the sequence number associated with a particular destination RF MAC address and source RF MAC address pair after each RF network message is generated.

This value shall be initialized with 32'd0. The first RF network messages produced for a particular destination RF MAC address and source RF MAC address pair shall be 32'd0.

24.3.2 RF Network Message Payload Structure

The RF network message (RFNM) payload consists of one or more TLV structures. The defined TLVs are contained in [Table 24-2](#).

Table 24-2. RF Network Message TLVs		
TLV	Type	Descriptions
Transmission Opportunity (TxOp) Assignment	1	This TLV is used by the time-division multiple access scheduler to allocate a transmission opportunity on a radio link.

<b>TLV</b>	<b>Type</b>	<b>Descriptions</b>
TxOp ID Acknowledgement Report	2	This TLV is used by a radio to report the acknowledgement of specific TxOps that have been received and processed and applied to the active schedule.
MAC Queue Status Report	3	This TLV is used by a radio to report MAC layer queue level.
Heartbeat	5	This TLV is used to establish a timeout value used by the radio to classify TxOps received from RF link management as stale.
Link Metric	6	This TLV contains an absolute time (converted to an internal representation) and link metric measurements pertaining to a specific radio link.
TE Queue Status Report	10	This TLV is used by a radio to report Traffic Engineering (TE) queue levels for each of the 8 TE queues associated with a particular link on the reporting radio.
Link Transmit Statistics Report	11	This TLV contains the count of IP packets transmitted over the specified RF link.

#### 24.3.2.1 TxOp Assignment TLV

The TxOp Assignment TLV shall be used to allocate transmission opportunities on a radio for the link comprised of the destination RF MAC address and source RF MAC address in the RF network message header. The TxOp Assignment TLV is described in [Table 24-3](#).

<b>Field</b>	<b>Width (bits)</b>	<b>Descriptions</b>	<b>Value/Range</b>
Type	8	Type: Transmission Opportunity Assignment	1
Length	8	Length in bytes	13
Center Frequency	16	Carrier or operating frequency given in units of 250 kilohertz (kHz) (up to 16 gigahertz [GHz])	[0, 2 <sup>16</sup> -1]
Reserved	8	This field is reserved for future use. The value shall be set to 8'h80.	8'h80
TxOp ID	16	An identifier for the TxOp. If the value of this field is set to zero (16'h0000), no acknowledgement for the TxOp will be provided through the TxOp ID Ack Report TLV.	[0, 2 <sup>16</sup> -1]
TxOp Timeout	8	The value specifying the number of consecutive epochs for which this transmission opportunity is valid. Additionally, the value of 8'h0 is reserved to indicate that any existing TxOp with a non-zero remaining timeout value whose interval is wholly contained by Start and Stop Subseconds field of this message is deleted from all future epochs. The value of 8'hFF is reserved to indicate that this TxOp	[0, 255]

<b>Table 24-3. TxOp Assignment TLV</b>			
<b>Field</b>	<b>Width (bits)</b>	<b>Descriptions</b>	<b>Value/Range</b>
		has an infinite lifetime and will remain in effect until explicitly deleted or until the transmission heartbeat times out.	
TxOp Start Subseconds	20	The value specifying the fractional subseconds portion of a TxOp start time, measured in microseconds relative to the start of the epoch.	[0, 999,999]
TxOp Stop Subseconds	20	The value specifying the fractional subseconds portion of a TxOp stop time, measured in microseconds relative to the start of the epoch.	[0, 1,000,000]

#### 24.3.2.2 TxOp ID Acknowledgement Report TLV

The TxOp ID Acknowledgement Report TLV shall be used to deliver one or more ID values of TxOps that have been applied to the transmission schedule of the transceiver. This TLV is not directly accountable to the link identified in the RFNM header of the message containing this TLV, thus a single RFNM may contain ID values from TxOps that were supplied to different links on the transceiver. Any TxOps whose ID value is set to zero (16'h0000) shall not be acknowledged. The TxOp ID Acknowledgement Report TLV is described in [Table 24-4](#).

<b>Table 24-4. TxOp ID Acknowledgement Report TLV</b>			
<b>Field</b>	<b>Width (bits)</b>	<b>Descriptions</b>	<b>Value/Range</b>
Type	8	Type: TxOp ID Ack Report	2
Length	8	Length in bytes	2+2N, where 'N' is the number of TxOpIds being acknowledged in this TLV
TxOp ID 1	16	The TxOp ID of the first TxOp being acknowledged in this TLV. Required.	[1, 2 <sup>16</sup> -1]
...	...	... Optional.	...
TxOp ID N	16	The TxOp ID of the Nth TxOp being acknowledged in this TLV. Optional.	[1, 2 <sup>16</sup> -1]

#### 24.3.2.3 MAC Queue Status Report TLV

The MAC Queue Status Report TLV shall be used to report the MAC layer queue level of the radio for the link comprised of the destination RF MAC address and source RF MAC address in the RF network message header. The MAC Queue Status Report TLV is described in [Table 24-5](#).

<b>Table 24-5. MAC Queue Status Report TLV</b>			
<b>Field</b>	<b>Width (bits)</b>	<b>Descriptions</b>	<b>Value/Range</b>
Type	8	Type: MAC Queue Status Report	3
Length	8	Length in bytes	8
Reserved	2	Reserved	2'b00

Field	Width (bits)	Descriptions	Value/Range
Timestamp Seconds	6	The value specifying the seconds portion of a timestamp of when the MAC Queue Status was sampled, measured in seconds and corresponding to the least significant 6 bits of the seconds portion of TAI time.	[0, 63]
Reserved	4	Reserved	4'b0000
Timestamp Subseconds	20	The value specifying the fractional sub-seconds portion of when the MAC Queue Status was sampled, measured in microseconds relative to the timestamp Seconds field.	[0, 999,999]
MAC Queue Level	16	Amount of data (reported in units of 64 bytes, rounded up) buffered in transceiver, pending transmission	[0, 2 <sup>16</sup> -1]

#### 24.3.2.4 Heartbeat TLV

The Heartbeat TLV shall be used to deliver an updated transmission heartbeat to a radio. The Heartbeat TLV is described in [Table 24-6](#).

Field	Width (bits)	Descriptions	Value/Range
Type	8	Type: Heartbeat	5
Length	8	Length in bytes	4
Timeout	16	Number of future epochs that this radio is authorized to execute TxOps. The value of 65,535 (16'hFFFF) is reserved to indicate a heartbeat that has an infinite lifetime and will remain in effect until explicitly changed.	[0, 2 <sup>16</sup> -1]

#### 24.3.2.5 Link Metric TLV

The Link Metric TLV shall be used to deliver receiver statistics for the link comprised of the destination RF MAC address and source RF MAC address in the RF network message header. The Link Metric TLV is described in [Table 24-7](#).

Field	Width (bits)	Descriptions	Value/Range
Type	8	Type	6
Length	8	Length in bytes	15
Timestamp	32	The time that this snapshot of Link Metric information was taken. This timestamp format consists of the following three subfields: Bits 31-26 - Reserved Bits 25-20 - seconds	6'b000000 [0-63]



<b>Table 24-7. Link Metric TLV</b>			
<b>Field</b>	<b>Width (bits)</b>	<b>Descriptions</b>	<b>Value/Range</b>
		Time, in seconds, when snapshot was taken, corresponding to the least-significant 6 bits of the seconds portion of TAI time Bits 19-0 - microseconds The fractional sub-second portion of the timestamp, measured in microseconds.	[0-999,999]
Center frequency	16	Indicates the center frequency where measurements are made. The center frequency is given in units of 250 kHz (up to 16 GHz)	$[0, 2^{16}-1]$
RSSI	8	Received signal strength indicator. This is a 2's compliment signed integer indicating the RSSI in 1-dBm step with a maximum range of -127 dBm to 127 dBm. The field is assigned -128 (hex 0x80) when RSSI measurement is not available.	[-128, 127]
CINR	8	Carrier to Interference + Noise Ratio. This is a 2's compliment signed integer indicating the CINR in 1-dB step with a maximum range of -127 dB to 127 dB. The field is assigned -128 (hex 0x80) when CINR measurement is not available.	[-128, 127]
Average channel bit error rate	8	This is an unsigned integer indicating the channel error rate in units of $1/2^8$ with a range of $1/2^8$ to $1-1/2^8$ . The field is assigned 0 when channel bit error rate measurement is not available.	$[0, 2^8-1]$
Received IP Packet Count	32	The number of IP packets that have been received over the RF link identified by the RFNM header.	$[0, 2^{32}-1]$

#### 24.3.2.6 Traffic Engineering Queue Status Report TLV

The TE Queue Status Report TLV shall be used to report the queue levels of the eight different TE queues of the radio for the link comprised of the destination RF MAC address and source RF MAC address in the RF network message header. The TE Queue Status Report TLV is described in [Table 24-8](#).

<b>Table 24-8. TE Queue Status Report TLV</b>			
<b>Field</b>	<b>Width (bits)</b>	<b>Descriptions</b>	<b>Value/Range</b>
Type	8	Type: TE Queue Status Report	10
Length	8	Length in bytes	27
Reserved	2	Reserved	2'b00
Timestamp Seconds	6	The value specifying the seconds portion of a timestamp of when the TE Queue Status was sampled, measured in seconds and	[0, 63]

<b>Table 24-8. TE Queue Status Report TLV</b>			
<b>Field</b>	<b>Width (bits)</b>	<b>Descriptions</b>	<b>Value/Range</b>
		corresponding to the least significant 6 bits of the seconds portion of TAI time.	
Reserved	4	Reserved	4'b0000
Timestamp Subseconds	20	The value specifying the fractional subseconds portion of when the TE Queue Status was sampled, measured in microseconds relative to the timestamp Seconds field.	[0, 999,999]
QoS Policy ID	32	Identifier for the QoS policy associated with this radio link	[0, 2 <sup>32</sup> -1] Default: 0
Version	8	Unique identifier for this specific queue status report: TE Queue depth	0
DSCP Class 0 Queue Level	16	Amount of data (reported in units of 64 bytes, rounded up) in the queue(s) for Diffserv Code Point (DSCP) Class 0 (DSCP values 0 to 7)	[0, 2 <sup>16</sup> -1]
DSCP Class 1 Queue Level	16	Amount of data (reported in units of 64 bytes, rounded up) in the queue(s) for DSCP Class 1 (DSCP values 8 to 15)	[0, 2 <sup>16</sup> -1]
DSCP Class 2 Queue Level	16	Amount of data (reported in units of 64 bytes, rounded up) in the queue(s) for DSCP Class 2 (DSCP values 16 to 23)	[0, 2 <sup>16</sup> -1]
DSCP Class 3 Queue Level	16	Amount of data (reported in units of 64 bytes, rounded up) in the queue(s) for DSCP Class 3 (DSCP values 24 to 31)	[0, 2 <sup>16</sup> -1]
DSCP Class 4 Queue Level	16	Amount of data (reported in units of 64 bytes, rounded up) in the queue(s) for DSCP Class 4 (DSCP values 32 to 39)	[0, 2 <sup>16</sup> -1]
DSCP Class 5 Queue Level	16	Amount of data (reported in units of 64 bytes, rounded up) in the queue(s) for DSCP Class 5 (DSCP values 40 to 47)	[0, 2 <sup>16</sup> -1]
DSCP Class 6 Queue Level	16	Amount of data (reported in units of 64 bytes, rounded up) in the queue(s) for DSCP Class 6 (DSCP values 48 to 55)	[0, 2 <sup>16</sup> -1]
DSCP Class 7 Queue Level	16	Amount of data (reported in units of 64 bytes, rounded up) in the queue(s) for DSCP Class 7 (DSCP values 56 to 63)	[0, 2 <sup>16</sup> -1]

#### 24.3.2.7 Link Transmit Statistics Report TLV

The Link Transmit Statistics Report TLV shall be used to report the number of IP packets transmitted by the transmitter over the link comprised of the destination and source RF MAC address in the RF network message header. [Table 24-9](#) describes the specifics of the link transmit statistics.

<b>Table 24-9. Link Transmit Statistics Report TLV</b>			
<b>Field</b>	<b>Width (bits)</b>	<b>Description</b>	<b>Value/Range</b>
Type	8	Type	11
Length	8	Length in bytes	10
Timestamp	32	The time that this snapshot of link transmission statistics was taken. This timestamp format consists of the following three subfields.	
		Bits 31-26 – reserved	6'b000000
		Bits 25-20 – seconds Time, in seconds, when snapshot was taken, corresponding to the least-significant 6 bits of the seconds portion of TAI time.	[0-63]
		Bits 19-0 – microseconds The fractional sub-second portion of the timestamp, measured in microseconds	[0-999,999]
Transmitted IP Packet Count	32	The number of IP packets that have been transmitted over the RF link identified by the RFNM header.	$[0, 2^{32}-1]$

#### 24.4 TSS Messages

TmNS Source Selector (TSS) functionality is described in [Chapter 28](#), but the TSS messages are defined in this section. The TSS messages shall be exchanged between TSS interfaces. There are two types of TSS messages defined:

- TSS Initialization Message
- TSS Data Message

##### 24.4.1 TSS Initialization Message Structure

After initial TCP socket connection is established, the TSS server (e.g., typically a radio) shall send 6 TSS initialization messages. The TSS initialization message structure shall contain the following fields as shown in [Figure 24-11](#).

- Interface Parameter Identifier – 4 bytes
- Interface Parameter – 32 bytes

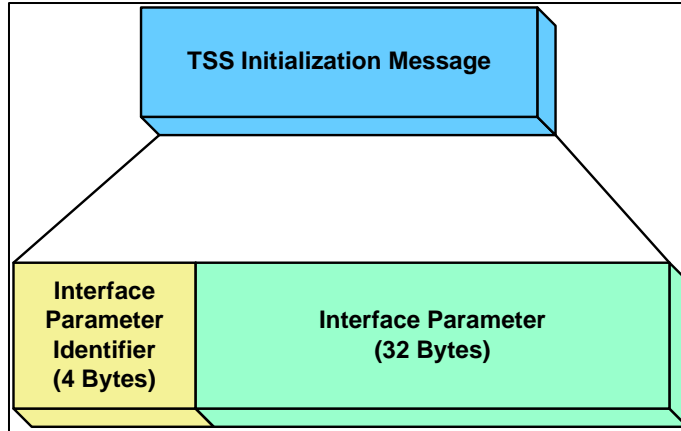

Figure 24-11. TSS Initialization Message Structure

#### 24.4.1.1 Interface Parameter Identifier

The Interface Parameter Identifier field shall contain one of the six values shown in [Table 24-10](#). These values have been chosen to match Linux input/output control (IOCTL) names that are shown so as to ease Linux implementations. The six TSS initialization messages shall be sent in the order shown in [Table 24-10](#).

<b>IOCTL Name</b>	<b>Description</b>	<b>Value</b>
SIOCSIFHWADDR	MAC address of the interface	32'h00008924
SIOCSIFMTU	Maximum transfer unit of the interface	32'h00008922
SIOCSIFADDR	Interface IP address of the interface	32'h00008916
SIOCSIFDSTADDR	Destination IP address of the interface when point to point	32'h00008918
SIOCSIFBRDADDR	Broadcast IP address for the interface	32'h0000891a
SIOCSIFNETMASK	Network mask for the interface	32'h0000891c

#### 24.4.1.2 Interface Parameter

The Interface Parameter field shall contain the value associated with the parameter.

#### 24.4.2 TSS Data Message Structure

A TSS data message is a wrapper used to aid specialized routing of network traffic between TmNS networks over other networks. The structure of a TSS data message is shown shall contain the following fields as shown in [Figure 24-12](#).

- Message Length – 16 bits
- Cyclic Redundancy Check (CRC) – 32 bits
- Encapsulated Ethernet Frame – variable length

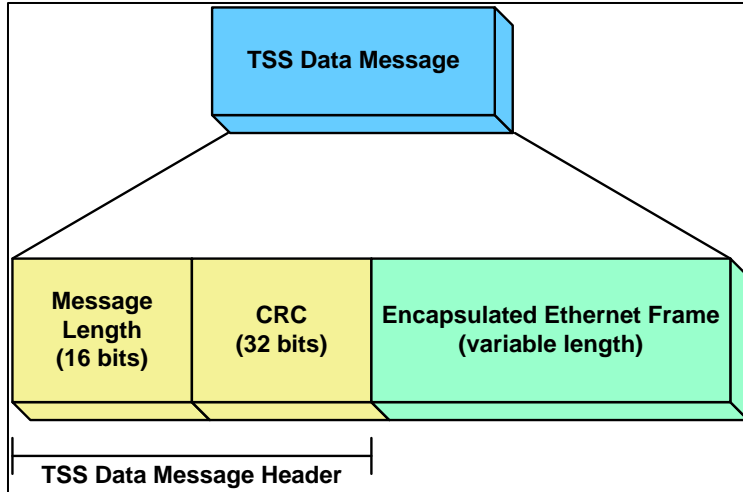

Figure 24-12. TSS Data Message Structure

#### 24.4.2.1 Message Length

This field indicates the remaining length in bytes of the TSS data message. The size of the TSS data message is the size of the Message Length field plus the value contained therein.

#### 24.4.2.2 Cyclic Redundancy Check (CRC)

The CRC field of the TSS data message serves as a message identifier for the TSS data message. The CRC calculation is performed on the entire Encapsulated Ethernet Frame of the message excluding the Ethernet header (e.g., offset by 14 bytes [6 dst + 6 src + 2 type]), with the result being stored in this field.

The polynomial to be used for CRC calculation shall be 32'h82608edb.

The algorithm for the CRC calculation shall be equivalent to that shown in [Figure 24-13](#). The constant POLY is defined as the polynomial listed above.

```

/*-----*/
/*-- get_crcByte - perform byte calculations for CRC process --*/
/*-----*/
static inline uint32_t get_crcByte(int input)
{
    uint32_t val = input;
    int i;

    for (i=0; i<8; i++)
    {
        if (val & 1)
            val = (val >> 1) ^ POLY;
        else val >>= 1;
    }

    return val;
}

/*-----*/
/*-- get_crc32 - calculate the 32-bit CRC of the provided buffer --*/
/*-----*/
static inline uint32_t get_crc32(unsigned char *data, int sz)
{
    uint32_t remainder, t1, t2;
    int bytes;

    remainder = 0;

    for (bytes = 0; bytes < sz; bytes++)
    {
        t1 = (remainder >> 8) & 0x0FFFFFFL;
        t2 = get_crcByte(((int)remainder^(*(data+bytes)))&0xFF);
        remainder = t1*t2;
    }

    for (bytes = 0; bytes < sizeof(remainder); bytes++)
    {
        t1 = (remainder >> 8) & 0x0FFFFFFL;
        t2 = get_crcByte(((int)remainder)&0xFF);
        remainder = t1*t2;
    }

    return remainder;
}

```

Figure 24-13. Algorithm For CRC Calculation (ANSI C Grammar)

**NOTE**

A reference implementation of TSS interfaces and functionality is available [here](#).

## 24.4.2.3 Encapsulated Ethernet Frame (Variable Length)

The Encapsulated Ethernet Frame field encapsulates an entire Ethernet frame so that it can be reproduced after transport.

**\*\*\*\* END OF CHAPTER 24 \*\*\*\***

## CHAPTER 25

### Management Resources

<b>Acronyms</b> .....	<b>25-iii</b>
<b>Chapter 25. Management Resources</b> .....	<b>25-1</b>
<b>25.1 General</b> .....	<b>25-1</b>
<b>25.2 Structure of Management Resources</b> .....	<b>25-1</b>
25.2.1 Public RFC-Based Management Resources .....	25-1
25.2.2 TmNS-Specific Management Resources .....	25-3
<b>25.3 Management Resource Matrix</b> .....	<b>25-5</b>
25.3.1 Hierarchy Element Class.....	25-6
25.3.2 Resource Name .....	25-6
25.3.3 Parent Resource Name .....	25-7
25.3.4 Resource Position.....	25-7
25.3.5 Resource URN .....	25-7
25.3.6 MIB Object Identifier (OID).....	25-7
25.3.7 Resource Syntax.....	25-7
25.3.8 Access Level .....	25-7
25.3.9 Default Value .....	25-8
25.3.10 Table Index # .....	25-8
25.3.11 Date Introduced.....	25-8
25.3.12 Persistent .....	25-8
25.3.13 Idempotency.....	25-8
25.3.14 Description .....	25-8
25.3.15 Comment.....	25-9
<b>25.4 Management Protocols</b> .....	<b>25-9</b>
25.4.1 SNMP-based ManagementResources .....	25-9
25.4.2 HTTP-based ManagementResources .....	25-9
25.4.3 TmNS Resource Management Protocols .....	25-11
<b>25.5 Uniform Resource Name</b> .....	<b>25-20</b>
<b>Appendix 25-A. Validation Examples</b> .....	<b>A-1</b>
<b>Appendix 25-B. Citations</b> .....	<b>B-1</b>

### List of Figures

Figure 25-1. TmNS-Specific Management Resources Hierarchy .....	25-3
Figure 25-2. SNMP-Based Management Resources Terminology Overview.....	25-9
Figure 25-3. HTTP-Based Management Resources Channel Overview .....	25-10
Figure 25-4. TmNS Configuration Negotiation Protocol Diagram .....	25-17

## List of Tables

Table 25-1.	RowStatus Values Overview .....	25-3
Table 25-2.	Hierarchy Element Classes .....	25-6
Table 25-3.	Management Resource Access Levels.....	25-7
Table 25-4.	Required and Optional Media Types .....	25-10



## Acronyms

DSCP	Differentiated Services Code Point
FTP	File Transfer Protocol
HTML	Hypertext Markup Language
HTTP	Hypertext Transfer Protocol
IANA	Internet Assigned Numbers Authority
IP	Internet Protocol
MDL	Metadata Description Language
MIB	management information base
NSS	namespace-specific string
OID	object identifier
RFC	Request for Comment
SNMP	Simple Network Management Protocol
TCP	Transmission Control Protocol
TMA	TmNS manageable application
TmNS	Telemetry Network Standard
UDP	User Datagram Protocol
URI	uniform resource identifier
URN	uniform resource name

This page intentionally left blank.

## CHAPTER 25

### Management Resources

#### 25.1 General

Each *Telemetry Network Standard (TmNS) manageable application (TMA)* defines a set of management resources, each of which defines application-specific data accessible via an application layer protocol. The term “management resources” is used throughout this document to describe resources that can be managed by managers. All TmNS-specific management resources reside within the *TmNS* management resources hierarchy, which is defined [here](#). Additionally, TmNS components may be required to provide host management resources. In all cases, management resources are used to provide a uniform and interoperable method for managing components and aspects of the TmNS system. There are two primary protocols for accessing the management resources: Simple Network Management Protocol (SNMP) and Hypertext Transfer Protocol (HTTP), which uses a RESTful architecture.

The TmNS-specific management resources are maintained in [this](#) spreadsheet. The spreadsheet provides a simple interface for maintaining each of the individual management resources. Each row in the spreadsheet describes a different management resource. The spreadsheet can be used to generate an ASN.1-formatted text file that serves as the TmNS management information base (MIB) (TMNS-MIB) for SNMP application. The spreadsheet contains additional mapping information, such as uniform resource names (URNs), for support of other management protocols.

#### 25.2 Structure of Management Resources

The structure of management resources is hierarchical. The TmNS-specific management resources are defined in detail in this standard. Additional management resources are defined through references to pre-existing Requests for Comment (RFCs). As a matter of interoperability, the hierarchy of pre-existing RFCs is used in an unmodified fashion.

##### 25.2.1 Public RFC-Based Management Resources

###### 25.2.1.1 Public RFC Management Information Base Support

Several management resources at the host level are defined in public RFC MIBs. The *TMA*s that implement *NetworkNode* management capabilities shall provide the following host-level management resources:

- SNMPv2-MIB (RFC 3418, Management Information Base [MIB] for the Simple Network Management Protocol [SNMP]<sup>1</sup>) snmpBasicComplianceRev2
- IF-MIB (RFC 2863, The Interfaces Group MIB <sup>2</sup>) ifCompliance3

---

<sup>1</sup> Internet Engineering Task Force. “Management Information Base (MIB) for the Simple Network Management Protocol (SNMP).” RFC 3418. December 2002. May be superseded or amended by update. Retrieved 17 May 2021. Available at <https://datatracker.ietf.org/doc/rfc3418/>.

<sup>2</sup> Internet Engineering Task Force. “The Interface Group MIB.” RFC 2863. June 2000. May be superseded or amended by update. Retrieved 17 May 2021. Available at <https://datatracker.ietf.org/doc/rfc2863/>.

- IP-MIB (RFC 4293, Management Information Base for the Internet Protocol [IP]<sup>3</sup>) ipMIBCompliance2
- TCP-MIB (RFC 4022, Management Information Base for the Transmission Control Protocol [TCP]<sup>4</sup>) tcpMIBCompliance2
- UDP-MIB (RFC 4113, Management Information Base for the User Datagram Protocol [UDP]<sup>5</sup>) udpMIBCompliance2

#### 25.2.1.2 Public RFC Management Information Base Support for Network Fabric Devices

Network fabric devices shall implement the *dot1dTpFdbTable* defined in RFC 4188<sup>6</sup> in order to provide layer-2 topology information.

Network fabric devices with static multicast routing capabilities shall implement the *dot1dStaticGroup* defined in RFC 4188 to provide configuration for the assignment of ports to multicast addresses:

#### 25.2.1.3 Notifications Support

All *TMA*s shall be capable of generating SNMP notifications. All *TMA*s shall implement the following MIB groups:

- SNMP-TARGET-MIB::snmpTargetBasicGroup
- SNMP-TARGET-MIB::snmpTargetResponseGroup
- SNMP-TARGET-MIB::snmpTargetCommandResponderGroup
- SNMP-NOTIFICATION-MIB::snmpNotifyGroup
- SNMP-NOTIFICATION-MIB::snmpNotifyFilterGroup

Related RFCs: RFC 3413: Simple Network Management Protocol (SNMP) Applications<sup>7</sup>

#### 25.2.1.4 Table Management using the RowStatus Column

All *TMA*s that include tables with a RowStatus column shall implement the RowStatus column operation in accordance with RFC 2579.<sup>8</sup>

---

<sup>3</sup> Internet Engineering Task Force. "Management Information Base for the Internet Protocol (IP)." RFC 4293. April 2006. May be superseded or amended by update. Retrieved 17 May 2021. Available at <https://datatracker.ietf.org/doc/rfc4293/>.

<sup>4</sup> Internet Engineering Task Force. "Management Information Base for the Transmission Control Protocol (TCP)." RFC 4022. March 2005. May be superseded or amended by update. Retrieved 17 May 2021. Available at <https://datatracker.ietf.org/doc/rfc4022/>.

<sup>5</sup> Internet Engineering Task Force. "Management Information Database for the User Datagram Protocol (UDP)." RFC 4113. June 2005. May be superseded or amended by update. Retrieved 17 May 2021. Available at <https://datatracker.ietf.org/doc/rfc4113/>.

<sup>6</sup> Internet Engineering Task Force. "Definitions of Managed Objects for Bridges." RFC 4188. September 2005. May be superseded or amended by update. Retrieved 7 July 2020. Available at <https://datatracker.ietf.org/doc/rfc4188/>.

<sup>7</sup> Internet Engineering Task Force. "Simple Network Management Protocol (SNMP) Applications." RFC 3413. December 2002. May be superseded or amended by update. Retrieved 17 May 2021. Available at <https://datatracker.ietf.org/doc/rfc3413/>.

<sup>8</sup> Internet Engineering Task Force. "Textual Conventions for SMIv2." RFC 2579. April 1999. May be superseded or amended by update. Retrieved 17 May 2021. Available at <https://datatracker.ietf.org/doc/rfc2579/>.



The RowStatus column is used to manage the creation and deletion of table rows as well as provide status. [Table 25-1](#) provides an overview of the RowStatus values for quick reference. Refer to RFC 2579 for additional information.

<b>Table 25-1. RowStatus Values Overview</b>			
<i>Value</i>	<i>Description</i>	<i>Command</i>	<i>Status</i>
active	Row is accessible	✓	✓
notInService	Row exists but is not currently accessible	✓	✓
notReady	Row exists but is missing information	✗	✓
createAndGo	Create a new row and have the row's status set to 'active'	✓	✗
createAndWait	Create a new row and have the row's status set to 'notReady'	✓	✗
destroy	Delete a row	✓	✗

### 25.2.2 TmNS-Specific Management Resources

All management resources that are TmNS-specific fall under the top-level hierarchy element “tmns”. These resources are categorized into the four sub-categories presented in [Figure 25-1](#).

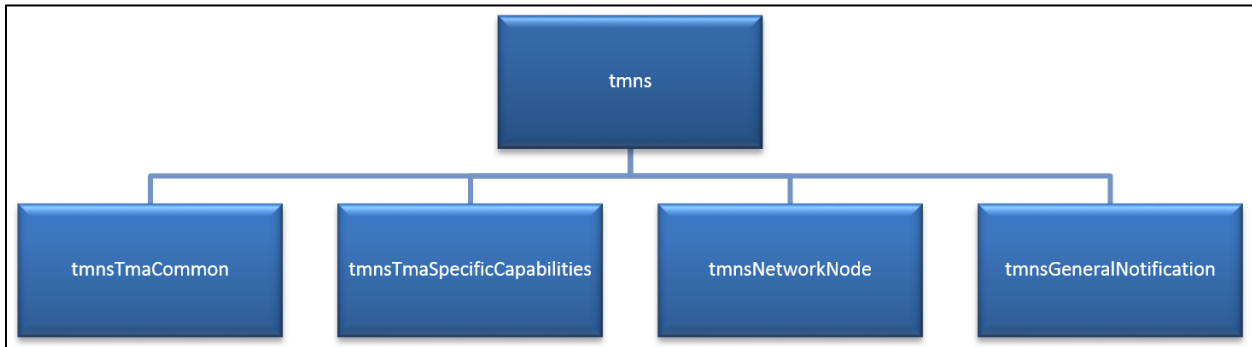

Figure 25-1. TmNS-Specific Management Resources Hierarchy



Only the first level sub-containers of management resources are mentioned in the sections below. As a matter of consolidating documentation, considerably more detail is provided in the management resource matrix.

#### 25.2.2.1 tmnsTmaCommon

The tmnsTmaCommon resource is a container of management resources that shall be available on all *TMA*s unless otherwise noted. It contains the following six resource containers:

- tmnsTmaCommonIdentification
- tmnsTmaCommonFault
- tmnsTmaCommonConfiguration
- tmnsTmaCommonControl
- tmnsTmaCommonStatus

- tmnsTmaCommonSecurity

All TmNS-specific management resources contained within this resource container are found in the [management resource matrix](#).

#### 25.2.2.2 tmnsTmaSpecificCapabilities

The tmnsTmaSpecificCapabilities resource is a container of management resources for application-specific capabilities. Resource containers that reside under the tmnsTmaSpecificCapabilities resource group management resources by capabilities. These resource containers are:

- tmnsNetworkFabricDevice
- tmnsACU
- tmnsDAU
- tmnsRecorder
- tmnsMasterClock
- tmnsSSTTx
- tmnsSSTRx
- tmnsAdapter
- tmnsRCDataSource
- tmnsLTCDDataSource
- tmnsLTCDDataSink
- tmnsConsolidatedManager
- tmnsRadio
- tmnsLinkManager
- tmnsRCDataSink
- tmnsVoiceGateway
- tmnsTPA
- tmnsPCMGateway
- tmnsNetworkGateway
- tmnsRAN
- tmnsTmnsSourceSelector

A *TMA* that supports a resource container shall support all management resources within that resource container unless otherwise noted.

All TmNS-specific management resources contained within this resource container are found in the [management resource matrix](#).

### 25.2.2.3 tmnsNetworkNode

The tmnsNetworkNode resource is a container of management resources that provide status and control capabilities that are specific to the host machine. For *NetworkNodes* that only run a single *TMA*, the *TMA* shall implement all management resources contained within the tmnsNetworkNode resource container. If more than one *TMA* are executed concurrently on a single *NetworkNode*, only one *TMA* is required to implement the management resources contained within the tmnsNetworkNode resource container. The *TMA*s that implement the tmnsNetworkNode resource container shall support all management resources within the tmnsNetworkNode resource container unless otherwise noted. The four resource containers contained within tmnsNetworkNode are the following:

- tmnsNetworkNodeIdentification
- tmnsNetworkNodeConfiguration
- tmnsNetworkNodeControl
- tmnsNetworkNodeStatus

All TmNS-specific management resources contained within this resource container are found in the [management resource matrix](#).

### 25.2.2.4 tmnsGeneralNotification

All *TMA*s shall be capable of generating event-based notifications. Management resources regarding general notifications are contained within the tmnsGeneralNotifications container resource. This container resource contains the following nine resource containers:

- configurationCompleteNotificationBranch
- timeLockLostNotificationBranch
- ieee1588MaxOffsetFromMasterNotificationBranch
- ieee1588MaxJitterNotificationBranch
- tempOutOfRangeNotificationBranch
- accessAnomalyDetectionNotificationBranch
- powerFaultNotificationBranch
- invalidInputNotificationBranch
- configurationChangeNotificationBranch

All TmNS-specific management resources contained within this resource container are found in the [management resource matrix](#).

## 25.3 Management Resource Matrix

The management resource matrix is the table that defines all TmNS-specific management resources. Each row in the matrix represents a management resource. Each column describes the resource. The matrix can be used to auto-generate files for various management protocols. A software tool has been provided that will convert the management resource matrix into an

ASN.1-formatted TMNS-MIB file that shall be used by applications that use the SNMP protocol. Another software tool provided converts the management resource matrix into a \*.json file that can be used by other available tools to auto-generate Hypertext Markup Language (HTML) documentation of the management resources as well as a basic HTTP clients and servers for a more RESTful approach to system management. Both tools are available from the zip file located [here](#). The TMNS-MIB.mib file and the TMNS-REST-API.json file have been generated from the tools and are available [here](#).

The columns of the matrix are described in more detail in the subsections that follow.

### 25.3.1 Hierarchy Element Class

This field indicates the class of the management resource with respect to its structure in the management resource hierarchy. The possible values are provided in [Table 25-2](#).

<b>Table 25-2. Hierarchy Element Classes</b>		
<b>Value</b>	<b>Name</b>	<b>Description</b>
B	Branch	A branch in the management resource hierarchy that may contain child entries.
I	Identity	An element that serves as the management resource module identifier for the TmNS.
S	Scalar	A leaf node in the management resource hierarchy.
N	Notification	A management resource that is used for asynchronous reporting of management resources based on some triggering condition.
T	Table	A hierarchical structure of management resources that may be duplicated across several instances. Management resources that comprise a table are the table sub-elements, each of which comprise a column of the table. Rows of a table correspond to each distinct instance of the collection of table sub-element management resources. Rows are unique based on a unique combination of the table's defined index values. A table may contain more than one index value in order to guarantee row uniqueness.
ts	Table Sub-element	An element of scalar type that comprises a column of the parent table.
TC	Textual Convention	A syntax definition that associates specific constraints with its type. Often these constraints resolve to an integer enumeration. The textual convention may be used as a valid resource syntax for other management resources.

### 25.3.2 Resource Name

This field contains the name of the management resource, which shall be unique across all TmNS-specific management resources.

The resource name shall map to the name of the MIB variable within the TMNS-MIB. Similarly, management resource names of the public RFC MIBs are already known.

The HTTP-based names beginning with “tmns” shall be considered as a short-cut to the longer equivalent name enforced by the TMNS-MIB. That is, iso:org:dod:internet:private:enterprises:tmns.

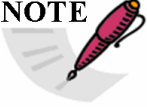

 <p><b>NOTE</b></p>	<p>Resource names in the management resource matrix have been chosen such that they are compatible with both known targets: SNMP and HTTP. The SNMP MIBs require uniqueness for all names within a MIB. The intention is for the management resource names to match that of the MIB variable names.</p>
--	---

25.3.3 Parent Resource Name

This field shall contain the name of its parent resource within the management resource hierarchy.

25.3.4 Resource Position

This field represents the resource’s child position with respect to its parent resource. The value of this field shall be an integer greater than zero and is not required to be sequential. The resource position shall be unique amongst all resources that share a common parent resource.

25.3.5 Resource URN

This field contains the URN associated with the resource. The syntax for TmNS-specific management resources is defined in Section [25.5](#).

25.3.6 MIB Object Identifier (OID)

This field represents the numerical hierarchy associated with the resource, beginning with the numerical value associated with the root of the TmNS-specific management resource tree, “tmns”, which has a value of 31409. For the complete MIB OID, see Subsection [25.4.1](#).

25.3.7 Resource Syntax

This field represents the syntax associated with the resource. Resources may utilize a syntax with constraints as well as syntax types that are defined by textual conventions within a supported public RFC or within the TmNS. Examples of syntax constraints may be in size limitation, range of acceptable values, and enumerations.

Resources that are textual conventions defined by the TmNS are not accessible resources for reading or writing. As such, these resources do not exist in the hierarchy of managed resources, e.g., they have neither a parent resource association nor a resource position.

 <p><b>NOTE</b></p>	<p>Resource syntax in the management resource matrix has been chosen such that they reflect the syntax type constraints associated with the MIB definition of the resources.</p>
--	--

25.3.8 Access Level

This field contains the type of access associated with the resource. The possible access levels and their descriptions are provided in [Table 25-3](#).

<b>Table 25-3. Management Resource Access Levels</b>	
<b>Value</b>	<b>Description</b>
read-only	The resource only supports reading and cannot be written.
read-write	The resource supports both reading and writing.
read-create	The resource supports both reading and writing and resides within a table that allows the creation of new rows (instances) through management via application layer protocols.

not-accessible	The resource does not support reading or writing. These resources are typically associated with tables and do have an associated syntax for the purpose of hierarchy structure.
<blank>	Resources that define textual conventions or only provide structure, such as parent resources, shall be left blank.

### 25.3.9 Default Value

Default values are given for all readable resources unless otherwise indicated. For instance, the default value for a table is an “empty” state because it has no rows.

In the case of read-only resources that report status, the defaults shall be applied during *TMA* initialization; the actual status value shall replace the default value once the *TMA* is able to acquire that status.

In the case of configuration and readable control resources, the default values listed shall be applied to the *TMA* when a *TMA* “Reset to Default” is executed.

### 25.3.10 Table Index #

This field shall be used by any table sub-element that serves as an index into the table. The value shall be an integer that indicates its index position in relation to any other indexes associated with the table.

For any resource that does not serve as an index into a table, this value shall be left blank.

### 25.3.11 Date Introduced

This field identifies the version of the standard in which the particular management resource was introduced into the standard. This is intended to aid in interoperability as the standard is updated and new resources are added or existing resources are updated.

### 25.3.12 Persistent

If the *Persistent* property is true, the resource’s value shall be retained across resets (including host loss of power) except when a *TMA* “Reset to Default” is executed. The *TmNS* management resources shall not be persistent except where specifically designated. Resources designated as persistent shall have their value stored in non-volatile memory whenever the resource is written. Persistent resources shall not retain their value when a *TMA* “Reset to Default” is executed.

### 25.3.13 Idempotency

A resource with the *Idempotency* property set to “true” indicates that a readable resource can be read multiple times without affecting the resource’s value and that a writeable resource can be written multiple times without adverse consequences. The *Idempotency* property shall apply to all *TmNS*-specific management resources except where specifically noted.

### 25.3.14 Description

This field describes the management resource. For some resources, specific behaviors and/or relationships to other management resources are defined. This field shall be used for documentation of the management resource. A description shall be provided for each management resource.

25.3.15 Comment

This field provides additional comments that may accompany a management resource or group of resources. Comments shall not include information that is needed for understanding how to use a particular resource or set of resources.

**25.4 Management Protocols**

Two application layer protocols provide access to the *ManagementResources*: SNMP and HTTP.

25.4.1 SNMP-based ManagementResources

All *TMA*s that provide or access SNMP-based management resources shall comply with the SNMP requirements specified in [Chapter 22](#). The TMNS-MIB contains all TmNS-specific management resources. At the top of the TmNS-specific management resource hierarchy is the resource “tmns”.

The TMNS-MIB has the following OID registered with the Internet Assigned Numbers Authority (IANA):

*Telemetry Network Standard (tmns)*: iso.org.dod.internet.private.enterprise.31409 (1.3.6.1.4.1.31409)

Documentation for the TMNS-MIB is part of the [management resource matrix](#). An ASN.1 formatted file can be generated from the management resource matrix and shall contain the available documentation for each resource identified by the TMNS-MIB. [Figure 25-2](#) depicts the network connection used to transport *SNMP requests* and *SNMP responses* between a manager and an agent.

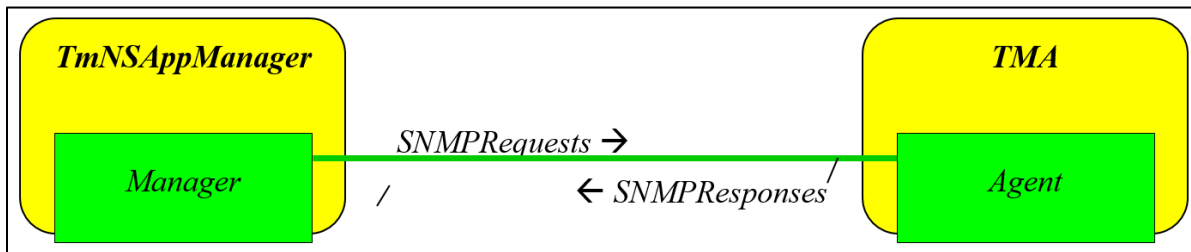

Figure 25-2. SNMP-Based Management Resources Terminology Overview

25.4.2 HTTP-based ManagementResources

All *TMA*s that provide or access HTTP-based resources shall comply with the HTTP requirements specified in [Chapter 22](#).

As depicted in [Figure 25-3](#), *ResourceChannel* identifies a network connection used to transport *ResourceRequests* and *ResourceResponses* between a *ResourceClient* and a *ResourceServer*. *ResourceClients* and *ResourceServers* using the *ResourceChannel* shall exchange *ResourceRequests* and *ResourceResponses* using the HTTP, as specified in [Chapter 22](#).



Figure 25-3. HTTP-Based Management Resources Channel Overview

The *ResourceClient* shall act as the HTTP client and the *ResourceServer* shall act as the HTTP server. Each *TMA* shall include a *ResourceServer*.

*ResourceClients* and *ResourceServers* shall transport *ResourceRequests* and *ResourceResponses* in the *ResourceChannel* using TCP.

The *ResourceChannel* shall use the same Differentiated Service Code Points (DSCPs) in both directions based on the DSCP selected by the *ResourceClient*.

The *ResourceChannel* shall support the following HTTP methods: GET, PUT, POST, and DELETE. Support for other HTTP methods is not required. The HTTP methods used in the *ResourceRequest* shall use the *TmNS\_Request\_Defined\_URI* to access *ResourceServer* resources.

Key *ResourceRequest* HTTP Request Headers:

Request Header	Value	Comments
Host	Domain name and TCP port of <i>ResourceServer</i> .	Required for all HTTP/1.1 requests
Accept	Media Type(s) (i.e., Content-Types) acceptable in the <i>ResourceResponse</i> .	See Media Type discussion in <a href="#">Table 25-4</a> .

Table 25-4. Required and Optional Media Types		
Required Media Types		
Media Type	Comments	Common Abbr
application/vnd.tmns.mdl+xml	IANA-registered Media Type for <i>TmNS Metadata Language</i>	MDL
application/vnd.tmns.arl+xml	IANA-registered Media Type for <i>TmNS Management Resources Language</i>	
Optional Media Types		
Media Type	Comments	
application/vnd.tmns.ihal+xml	IANA-registered Media Type for <i>TmNS Instrumentation Hardware Abstraction Language</i>	IHAL
application/xml	Generic XML document exchange	
text/html	Serve HTML pages to a web browser	
text/plain	Web browser support via Javascript or similar protocol	

others	Other Media Types may be implemented at the vendor’s discretion (although other representations are outside the scope of these standards).	
--------	--	--

If a *ResourceRequest* or *ResourceResponse* includes an Entity Body, the following HTTP headers shall be in the *ResourceRequest* or *ResourceResponse* respectively:

Response Header	Value	Comments
Content-Type	The Media Type of the <i>ResourceResponse</i> body.	See Media Type discussion in <a href="#">Table 25-4</a> .
Content-Length	Length of <i>ResourceResponse</i> body in bytes.	
Location	Used in redirection	Primarily used for resource creation and asynchronous operations

	<b>NOTE</b> Supporting multiple Accept header values provides a <i>ResourceServer</i> the capability to support multiple interfaces for the same resource. For example: the GET {rootPath}/dataChannel method could return a media type of “text/html” and thereby provide the Data Channel List as an HTML page (i.e., web page) rather than as an XML document.
---	---

If a *ResourceServer* receives a *ResourceRequest* for an unrecognized or unsupported *Resource*, the *ResourceServer* shall return a status code of 404, Not Found.

If a *ResourceServer* receives a *ResourceRequest* with an unrecognized uniform resource identifier (URI) parameter (*TmNSparam*), the *ResourceServer* shall return an error response with all pertinent information included in the error message and a status code of 400, Bad Request.

If a *ResourceServer* receives a *ResourceRequest* and is unable to process the request due to an internal *ResourceServer* problem, the *ResourceServer* shall return an error response with all pertinent information included in the error message and a status code of 500, Internal Server Error.

### 25.4.3 TmNS Resource Management Protocols

#### 25.4.3.1 Device Configuration Protocol

All *TMA*s shall support the transfer of configuration files (e.g., Metadata Description Language [MDL] instance documents) using the File Transfer Protocol (FTP) as specified in [Chapter 22](#).

All *TMA*s should support the transfer of configuration files using the HTTP as specified in [Chapter 22](#).

##### 25.4.3.1.1 Configuration Protocol for *TMA*s

The *TMA* Configuration Protocol is a sequence of steps executed between a *TmNSApp* manager and a target *TMA* to configure the target *TMA* using an MDL instance document.

The *TMA* Configuration Protocol is comprised of the following steps.

1. The *TmNSApp* manager sets the **tmnsTmaCommon:tmnsTmaCommonConfiguration:configurationURI** resource on the target *TMA* to the location of the configuration file.
2. The *TmNSApp* manager sets the **tmnsTmaCommon:tmnsTmaCommonConfiguration:configure** resource on the target *TMA* to “true”. Once a *TmNSApp* manager has set the **tmnsTmaCommon:tmnsTmaCommonConfiguration:configure** resource to “true”, any attempt by the *TmNSApp* manager to change the resource’s value shall be ignored until the target *TMA* has set the resource’s value to “false”.

 <p><b>NOTE</b></p>	<p>To cancel the configuration process, a <i>TmNSApp</i> manager may execute either a <i>TMA</i> reset or a <i>TmNSHost</i> reset.</p>
--	--

3. Upon receipt of the **tmnsTmaCommon:tmnsTmaCommonConfiguration:configure** resource being set to true, the *TMA* shall retrieve the configuration file indicated by the **tmnsTmaCommon:tmnsTmaCommonConfiguration:configurationURI** resource. If a retrieval error occurs, the *TMA* shall follow the steps outlined in Subsection [25.4.3.1.2](#).
4. Upon successful retrieval of the configuration file, the *TMA* parses and checks the retrieved configuration file. The *TMA* is not required to perform an XML validation of the configuration file (the *TMA* may assume the configuration is valid with respect to its schema). If an anomaly is detected, the *TMA* shall follow the steps outlined in Subsection [25.4.3.1.2](#).
5. The *TMA* applies the changes found in the configuration file. If an error is detected, the *TMA* shall follow the steps outlined in Subsection [25.4.3.1.2](#).
6. When all changes have been successfully applied to the *TMA* (i.e., configuration is complete), the *TMA* shall:
  - a. Update the *TMA*’s **tmnsTmaCommon:tmnsTmaCommonConfiguration:configurationVersion** resource according to the format specified in the description of this resource in the management resource matrix.
  - b. Set the *TMA*’s **tmnsTmaCommon:tmnsTmaCommonStatus:tmaStateNumber** resource to “2” and **tmnsTmaCommon:tmnsTmaCommonStatus:tmaStateString** resource to “Configured”.
  - c. Set the *TMA*’s **tmnsTmaCommon:tmnsTmaCommonConfiguration:configChangeCounter** resource to “0”.
  - d. Set the *TMA*’s **tmnsTmaCommon:tmnsTmaCommonConfiguration:configure** resource to “false”.
  - e. Send a configurationCompleteNotification via the **tmnsGeneralNotification:configurationCompleteNotificationBranch:configurationCompleteNotifications:configurationCompleteNotification** resource. The notification shall indicate a successful configuration attempt.

- f. Set the internal state of the configuration “dirty bit” value of the *TMA* to “false”.

The intent of the configuration “dirty bit” state is to indicate when the configuration of a *TMA* has changed through a manner other than through the configuration protocol outlined above. The value of the <DirtyBit> element within the MDL instance document that a *TMA* is configured with is ignored by the *TMA* during configuration. If no changes are made to the configuration of a *TMA* between a successful configuration attempt and an export configuration (Subsection [25.4.3.2.1](#)), the <DirtyBit> element of the exported MDL instance document produced by the *TMA* shall be “false”.

A resource that is not set during the configuration process shall retain its previous value unless its behavior during configuration is explicitly stated to do otherwise. In the case where configuration creates rows in a table, default values shall be used for the new rows if not explicitly set during the configuration process.

If a configuration error occurs, the *TMA* shall follow the steps outlined in Subsection [25.4.3.1.2](#).

	<p><b>NOTE</b> A <i>TMA</i> is only required to store configuration information applicable to itself (i.e., storing configuration information of other <i>TMA</i>s is not required).</p>
---	--

#### 25.4.3.1.2 Configuration Error Handling

If the *TMA* detects an error during the configuration process, the *TMA* shall adhere to the following steps.

1. The *TMA* shall follow one of the two following approaches in this step:
  - a. The *TMA* shall attempt to restore the previous configuration prior to the initiating of the configure attempt. If the *TMA* is able to restore the previous configuration, the *TMA* shall set its **tmnsTmaCommon:tmnsTmaCommonConfiguration:configurationVersion**, **tmnsTmaCommon:tmnsTmaCommonStatus:tmaStateNumber**, and **tmnsTmaCommon:tmnsTmaCommonStatus:tmaStateString** resources to their previous values prior to the initiation of the configuration process. If the *TMA* was actively publishing or subscribing to *TmNSDataMessages* prior to the initiating of the configuration attempt, it shall not return to that mode of operation. Rather, a *TMA* that recovers from a failed configuration attempt shall not begin publishing or subscribing to *TmNSDataMessages* until further commanded to do so by a *TmNSApp* manager. The value of the *TMA*’s internal configuration “dirty bit” state shall remain the same as it was prior to the failed configuration attempt. If the *TMA* is unable to restore the previous configuration as described, the *TMA* shall utilize the other error handling approach described below in 1b.
  - b. The *TMA* shall set its **tmnsTmaCommon:tmnsTmaCommonConfiguration:configurationVersion** resource to an empty string in accordance with the description of the resource in the management resource matrix. The *TMA* shall set its **tmnsTmaCommon:tmnsTmaCommonStatus:tmaStateNumber** resource to

“1” and its **tmnsTmaCommon:tmnsTmaCommonStatus:tmaStateString** resource “Unconfigured”. The *TMA* shall not publish or subscribe to any *TmNSDataMessages* until after a successful configuration attempt. The value of the *TMA*’s internal configuration “dirty bit” state shall be set to “true”.

<p><b>NOTE</b></p> 	<p>A <i>TMA</i> is not required to restore any previous state after a configuration failure. Approach 1a is expected to be used by <i>TMA</i>s that are capable of restoring the previous configuration state.</p>
--	--

2. The *TMA* shall set the **tmnsTmaCommon:tmnsTmaCommonFault:activeFaultsTable:faultNumber** and **tmnsTmaCommon:tmnsTmaCommonFault:activeFaultsTable:faultString** resources to the appropriate value into a row in the **tmnsTmaCommon:tmnsTmaCommonFault:activeFaultsTable**.
3. The *TMA* shall set its **tmnsTmaCommon:tmnsTmaCommonConfiguration:configure** resource to “false”.
4. The *TMA* shall send a *configurationCompleteNotification* via the **tmnsGeneralNotification:configurationCompleteNotificationBranch:configurationCompleteNotifications:configurationCompleteNotification** resource. The notification shall indicate a failed configuration attempt.

<p><b>NOTE</b></p> 	<p>The following are examples of possible configuration errors.</p> <ol style="list-style-type: none"> <li>a. The transfer of the configuration file fails.</li> <li>b. An incomplete or invalid configuration file is received.</li> <li>c. A value specified in the configuration file conflicts with a <i>TMA</i> constant or allowable value range.</li> </ol>
---	--

#### 25.4.3.2 File Export Protocols

All *TMA*s shall support the exporting of files via the processes defined in the following subsection.

##### 25.4.3.2.1 Export Configuration File Protocol for *TMA*s

The Export Configuration File Protocol for *TMA*s is a sequence of steps executed between a *TmNSApp* manager and a target *TMA* to retrieve the target *TMA*’s current configuration state via an MDL instance document.

The Export Configuration File Protocol is comprised of the following steps.

1. The *TmNSApp* manager sets the **tmnsTmaCommon:tmnsTmaCommonConfiguration:configurationExportURI** resource on the target *TMA* to a destination location for the configuration file.
2. The *TmNSApp* manager sets the **tmnsTmaCommon:tmnsTmaCommonConfiguration:exportConfiguration** resource on the target *TMA* to “true”. Once a *TmNSApp* manager has set the **tmnsTmaCommon:tmnsTmaCommonConfiguration:exportConfiguration** resource to “true”, any attempt by the *TMA* manager to change the resource’s value shall be ignored until the target *TMA* has set the resource’s value to “false”.



 <p><b>NOTE</b></p>	<p>To cancel the export configuration file process, a <i>TmNSApp</i> manager may execute either a <i>TMA</i> reset or a <i>TmNSHost</i> reset.</p>
--	--

3. Upon receipt of the **tmnsTmaCommon:tmnsTmaCommonConfiguration:exportConfiguration** resource being set to “true”, the *TMA* shall send an MDL file that contains the description of the *TMA*’s current configuration to the destination location indicated by the **tmnsTmaCommon:tmnsTmaCommonConfiguration:configurationExportURI** resource. The <DirtyBit> element in the exported MDL file shall contain the *TMA*’s current state of its configuration “dirty bit”. The “dirty bit” state is only set to “false” after a successful configuration attempt, and it shall be set to “true” when the configuration state is changed in a manner other than through the configuration protocol (Subsection [25.4.3.1.1](#)).

 <p><b>NOTE</b></p>	<p>Once the configuration “dirty bit” is set to “true” on the <i>TMA</i>, it should remain “true” until a successful reconfiguration attempt is accomplished according to Subsection <a href="#">25.4.3.1.1</a>.</p>
--	--

4. Upon completion of the file transfer process (successful or failed), the *TMA* shall set the *TMA* **tmnsTmaCommon:tmnsTmaCommonConfiguration:exportConfiguration** resource to “false”.
5. If an error occurs, the *TMA* shall set the **tmnsTmaCommon:tmnsTmaCommonFault:activeFaultsTable:faultNumber** and **tmnsTmaCommon:tmnsTmaCommonFault:activeFaultsTable:faultString** resources to the appropriate value into a row in the **tmnsTmaCommon:tmnsTmaCommonFault:activeFaultsTable**.

 <p><b>NOTE</b></p>	<p>The full state of the <i>TMA</i> is represented by its stored configuration information (i.e., information transportable via an MDL instance document) and the state of the <i>TMA</i>’s resources. The exported MDL file should contain all updates of management resources that are described in the MDL schema; however, some resources are not represented in the MDL schema, such as the recording state of a recorder, and are only available through other management resource access methods. Thus, it may be necessary for a <i>TmNSApp</i> manager to retrieve the current values of a <i>TMA</i>’s resources in conjunction with retrieving an MDL file with its current configuration state via the export process.</p>
--	--

A successfully exported MDL instance document from a *TMA* shall be capable of reconfiguring the original *TMA* into the configuration state at the time of the export process. In other words, reconfiguring a *TMA* with its exported MDL configuration file immediately after a successful export configuration process completes shall result in a successful configuration of the *TMA*.

### 25.4.3.2.2 Export Log File Protocol for TMAs

The Export Log File Protocol for *TMAs* is a sequence of steps executed between a *TmNSApp* manager and a target *TMA* to retrieve the target *TMA*'s log file.

The Export Log File Protocol is comprised of the following steps.

1. The *TmNSApp* manager sets the **tmnsTmaCommon:tmnsTmaCommonControl:logFileExportURI** resource on the target *TMA* to a destination location for the log file.
2. The *TmNSApp* manager sets the **tmnsTmaCommon:tmnsTmaCommonControl:exportLogFile** resource on the target *TMA* to "true". Once a *TmNSApp* manager has set the **tmnsTmaCommon:tmnsTmaCommonControl:exportLogFile** resource to "true", any attempt by the *TmNSApp* manager to change the resource's value shall be ignored until the target *TMA* has set the resource's value to "false".



3. Upon receipt of the **tmnsTmaCommon:tmnsTmaCommonControl:exportLogFile** resource being set to "true", the *TMA* shall send its log file to the destination location indicated by the **tmnsTmaCommon:tmnsTmaCommonControl:logFileExportURI** resource.
4. Upon completion of the file transfer process (successful or failed), the *TMA* shall set the *TMA* **tmnsTmaCommon:tmnsTmaCommonControl:exportLogFile** resource to "false".
5. If an error occurs, the *TMA* shall set the **tmnsTmaCommon:tmnsTmaCommonFault:activeFaultsTable:faultNumber** and **tmnsTmaCommon:tmnsTmaCommonFault:activeFaultsTable:faultString** resources to the appropriate value into a row in the **tmnsTmaCommon:tmnsTmaCommonFault:activeFaultsTable**.

### 25.4.3.3 TmNS Configuration Negotiation Protocol

*NetworkNodes* that sample and package data and *TmNSAppManagers* that construct MDL files shall implement the TmNS Configuration Negotiation Protocol. The protocol consists of a dialog between the *TmNSAppManager* and the data acquisition *NetworkNode*. The protocol is used to communicate the desired set of measurements to be produced and the capability of the acquisition device to provide the data at the requested rates.

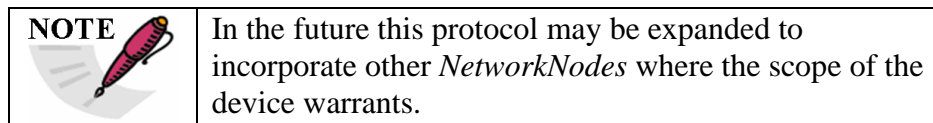

The communication between the negotiating entities utilizes HTTP ([Chapter 22 Subsection 22.5.2.2](#)), SNMP ([Chapter 22 Subsection 22.5.2.1](#), this chapter), and FTP ([Chapter 22 Subsection 22.5.2.4](#)). The communication workflow is depicted in [Figure 25-4](#).

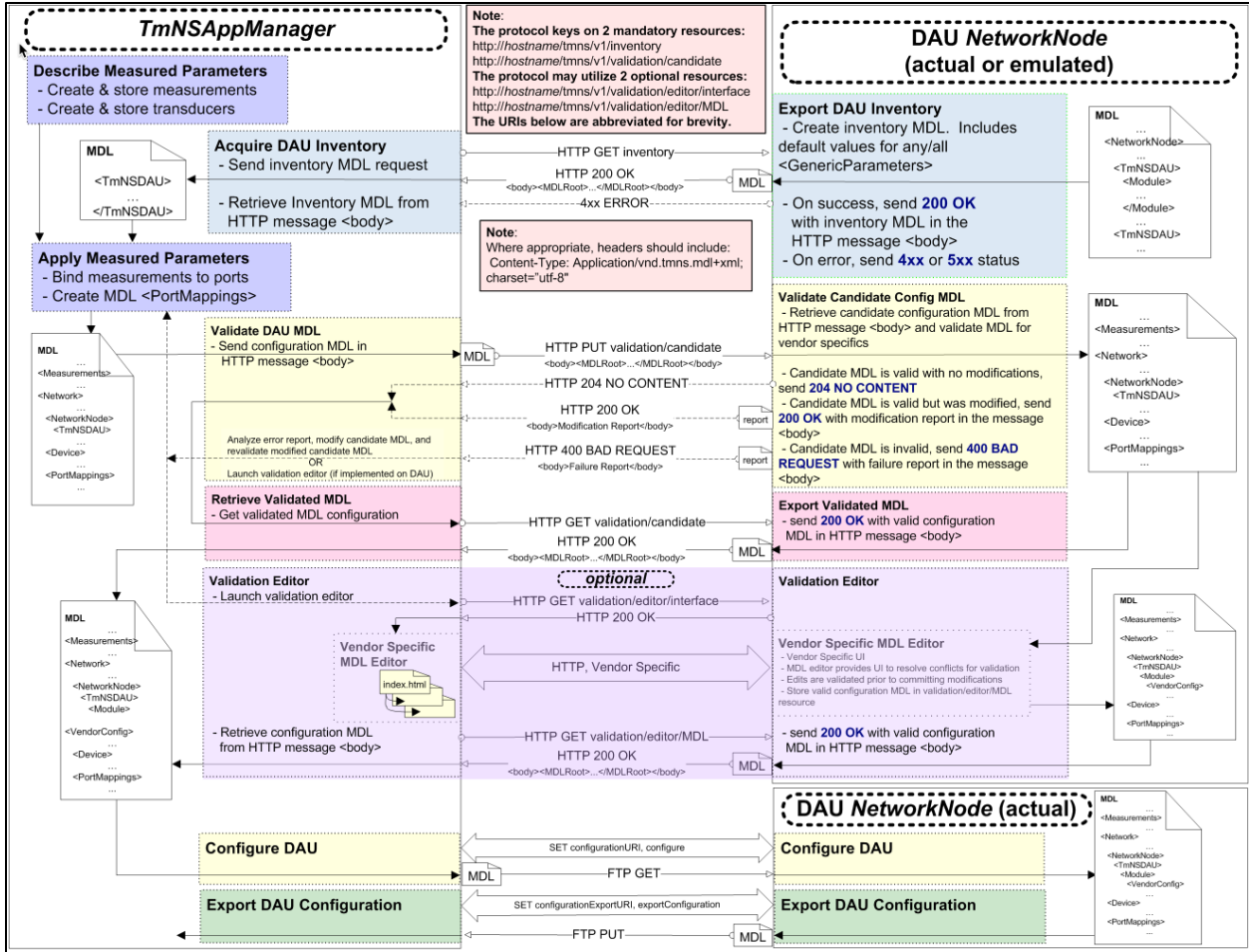

Figure 25-4. TmNS Configuration Negotiation Protocol Diagram

[Figure 25-4](#) identifies two reports, the modification report and the failure report. [Appendix 25-A](#) contains examples of these reports to provide a basic common framework for reporting.

The *TmNS* Configuration Negotiation Protocol is a sequence of steps executed between a *TmNSAppManager* and a data acquisition *NetworkNode* to build a valid MDL instance document containing the data acquisition *NetworkNode* configuration.

The *TmNS* Configuration Negotiation Protocol is comprised of the following steps.

1. The *TmNSAppManager* retrieves inventory from the data acquisition *NetworkNode* by accessing the Inventory Resource on data acquisition *NetworkNode*.
2. The *TmNSAppManager* binds measurement information to the data acquisition *NetworkNode* inventory, creating a candidate for the data acquisition *NetworkNode* configuration.
3. The *TmNSAppManager* sends the candidate MDL instance document to the Validation Candidate Resource on the data acquisition *NetworkNode*. This initiates the validation process on the *NetworkNode*, but it does not actually configure the data acquisition *NetworkNode*. The standard HTTP response provides the result of the validation operation.

- a. If data acquisition *NetworkNode* considers the candidate MDL instance valid, the *NetworkNode* will update the Validation Candidate Resource with the candidate MDL instance document. The response will indicate success to the *TmNSAppManager*.
  - b. If the data acquisition *NetworkNode* considers the candidate MDL instance document valid only after the *NetworkNode* modified the content of the candidate MDL instance document during the validation process, the *NetworkNode* will update the Validation Candidate Resource with the candidate MDL instance document and all associated annotations provided by the *NetworkNode* during the validation process. The response will indicate success to the *TmNSAppManager* and shall contain a modification report of the modifications. The content of the modification report is outside the scope of this standard.
  - c. If the data acquisition *NetworkNode* does not consider the candidate MDL instance document valid, the *NetworkNode* shall return an error with a detailed failure report in the response. The *NetworkNode* shall still update the Validation Candidate Resource even though it is deemed an invalid configuration for the device. The content of the failure report is outside the scope of this standard. From this point, a user may repeat Step 3 by sending a new candidate MDL instance document to the *NetworkNode*, or access the optional Validation Editor Interface Resource if one is available on the *NetworkNode*.
  - d. If the candidate MDL instance document is not MDL-schema valid, the *NetworkNode* shall return an unsupported media type error.
4. Once the data acquisition *NetworkNode* validates the candidate MDL instance document, the *TmNSAppManager* retrieves the valid configuration from the Validation Candidate Resource (or the Validation Editor MDL Resource, if applicable) on the data acquisition *NetworkNode*.
  5. The *TmNSAppManager* may configure the data acquisition *NetworkNode* with the valid configuration via the TMA Configuration Protocol (see Subsection [25.4.3.1.1](#)).

#### 25.4.3.3.1 *TmNS Inventory Resource*

Data acquisition *NetworkNodes* shall document their inventory in an MDL instance document by implementing the Inventory Resource at the URI, */tmns/v1/inventory*. The inventory of the *NetworkNode* shall consist of the hardware modules that comprise the *NetworkNode* and may also contain the capabilities of the associated hardware modules. The Inventory Resource shall support the HTTP GET method. The Inventory Resource shall indicate success by returning a *200 OK* response containing the inventory MDL instance document in the body. The MDL instance document shall include default values for any and all GenericParameters required by the device. The data acquisition *NetworkNode* may indicate errors by returning an appropriate *4xx* or *5xx* status code response.

#### 25.4.3.3.2 *TmNS Validation Candidate Resource*

Data acquisition *NetworkNodes* shall augment the *TmNS* Configuration Protocol (see Subsection [25.4.3.1.1](#)) by implementing the Validation Candidate Resource at the URI */tmns/v1/validation/candidate*. The Validation Candidate Resource shall support the HTTP PUT and GET methods.

This resource shall validate the candidate MDL instance document when accessed by a PUT method. The body of the PUT request shall contain the candidate MDL instance document

to be validated by the *NetworkNode*. The PUT request for the Validation Candidate Resource shall return one of the following response codes.

- *204 NO CONTENT*: This response shall be used to indicate that the candidate MDL instance document represented a valid configuration without any modification. The body of the response shall be empty. Validation is successful, and the Validation Candidate Resource shall be updated to contain the candidate MDL instance document.
- *200 OK*: This response shall be used to indicate that the candidate MDL instance document was modified in order to represent a valid configuration. The body of the response shall contain a modification report. Validation is successful, and the Validation Candidate Resource shall be updated to contain the modified representation of the candidate MDL instance document.
- *400 BAD REQUEST*: The Validation Candidate Resource represents a validation failure, and the body of the response shall contain a detailed failure report of the reason(s) for the failure. The Validation Candidate Resource shall be updated, but the value represents an invalid configuration for the *NetworkNode*.
- *415 UNSUPPORTED MEDIA TYPE*: This response shall be used to indicate that the candidate MDL instance document sent in the PUT request does not comply with the MDL schema defined in [Chapter 23](#).

A GET request for the Validation Candidate Resource shall return one of the following response codes.

- *200 OK*: The Validation Candidate Resource represents a valid configuration for the *NetworkNode*, and the body of the response message contains the valid MDL instance document.
- *400 BAD REQUEST*: The Validation Candidate Resource represents a validation failure, and the body of the response contains the invalid MDL instance document.
- *428 PRECONDITION REQUIRED*: The Validation Candidate Resource is not available, and the body of the response is empty.

#### 25.4.3.3.3 *TmNS Validation Editor Interface Resource*

The Validation Editor Interface Resource is an optional resource that may be implemented by a data acquisition *NetworkNode*. If implemented, the Validation Editor Interface Resource shall support the HTTP GET method. If not implemented, the GET request shall return a *404 NOT FOUND* response.

A GET request for the Validation Editor Interface Resource shall launch an editor that allows the user to modify MDL content and manipulate vendor-specific settings. When the editor is launched, a *200 OK* response message is returned. The editor opens the Validation Candidate Resource, whether valid or not, but it does not update that resource. The user interacts with the data acquisition *NetworkNode* through the editor interface. Upon saving any choices made by a user within the editor, the editor shall validate the resulting MDL instance document. If the

resulting MDL instance document is valid for the *NetworkNode*, the MDL instance document shall be saved to the Validation Editor MDL Resource.

#### 25.4.3.3.4 *TmNS Validation Editor MDL Resource*

The Validation Editor MDL Resource shall be implemented by a data acquisition *NetworkNode* if the Validation Editor Interface Resource is implemented. The Validation Editor MDL Resource shall support the HTTP GET method.

A GET request for the Validation Editor MDL Resource shall return one of the following response codes.

- **200 OK:** The Validation Editor MDL Resource represents a valid MDL instance document for the *NetworkNode*, and it is sent in the body of the response message. The valid MDL instance document is a result of invoking the TmNS Validation Editor Interface Resource and resolving all conflicts within the editor.
- **428 PRECONDITION REQUIRED:** The Validation Editor MDL Resource is blank, and the body of the response is empty. This results from a user not saving off a valid MDL instance document through the editor provided through the Validation Editor Interface Resource.
- **404 NOT FOUND:** The Validation Editor MDL Resource is not implemented.

## 25.5 Uniform Resource Name

The *TmNS* management resources hierarchy uses the URN defined in RFC 2141.<sup>9</sup> The general syntax is specified below:

URN = "urn:" Namespace ID ":" Namespace Specific String (NSS)

For TmNS-specific management resources, the *TmNSURN*, "tmns" is assigned as the Namespace ID resulting in:

*TmNSURN* = "urn:tmns:" Namespace Specific String (NSS)

The Namespace Specific String (NSS) identifies a specific resource or set of resources under the *TmNS* Namespace. Examples:

- **urn:tmns:tmnsTmaCommon:tmnsTmaCommonIdentification** identifies all of the resources under the tmnsTmaCommonIdentification resource.
- **urn:tmns:tmnsTmaCommon:tmnsTmaCommonIdentification:tmaProductName** specifically identifies the tmaProductName resource.

To reduce documentation clutter, the "urn:tmns" is typically left off a resource's name. For example: the tmaProductName resource would be identified as the **tmnsTmaCommon:tmnsTmaCommonIdentification:tmaProductName** resource.

---

<sup>9</sup> Internet Engineering Task Force. "URN Syntax." RFC 2141. Obsoleted by RFC 8141. May 1997. Retrieved 17 May 2021. Available at <https://datatracker.ietf.org/doc/rfc2141/>.

## APPENDIX 25-A

### Validation Examples

This appendix contains examples for the MDL validation reporting as discussed in this chapter.

#### A.1. Example MDL Validation Report

```
<?xml version="1.0" encoding="UTF-8"?>
<?xml-stylesheet type="text/xsl" href="mdl-validation-report-20150326.xsl"?>
<VRLRoot>
  <Timestamp>2015-03-17T10:45:23</Timestamp>
  <MdlInstanceDocument>
    <Name>PackagingMeasurements.xml</Name>
    <RoleId>DAU1App</RoleId>
    <NetworkName>Example Network</NetworkName>
    <ConfigurationVersion>0.0.1</ConfigurationVersion>
    <DatabaseId>development</DatabaseId>
  </MdlInstanceDocument>
  <ValidationEnvironment>
    <AppVersion>0.1.2</AppVersion>
    <AppConfiguration>optimization level: 2; constraints setting:
      default</AppConfiguration>
  </ValidationEnvironment>
  <Message>
    <Level>WARNING</Level>
    <Description>Invalid upper input range value: 1.17</Description>
    <HelperUri>https://www.tena-sda.org/display/INET/home</HelperUri>
    <Context>
      <MdlId>GearVibMeas</MdlId>
      <Comment>Measurement GEARVIB anomaly</Comment>
    </Context>
  </Message>
  <Message>
    <Level>ERROR</Level>
    <Description lang="fr">Invalide MAC Adresse:
      00:00:00:00:00:00</Description>
    <Context>
      <MdlId>Dau1IFace</MdlId>
      <Comment>DAU1 network anomaly</Comment>
    </Context>
  </Message>
  <Message>
    <Level>ERROR</Level>
    <Description>Invalid Configuration Version</Description>
    <HelperUri>https://www.tena-sda.org/display/INET/home</HelperUri>
    <Context>
      <MdlId>none</MdlId>
      <Comment>Configuration Version requires embedded timestamp</Comment>
    </Context>
  </Message>
</VRLRoot>
```

## A.2. Stylesheet for the Example MDL Validation Report

```

<?xml version="1.0" encoding="UTF-8"?>
<xsl:stylesheet xmlns:xsl="http://www.w3.org/1999/XSL/Transform"
version="1.0">
  <xsl:output method="html"/>
  <xsl:template match="/VRLRoot">
    <html>
      <head>
        <title>MDL Validation Report</title>
        <style type="text/css">
          body
          {
            margin:10px;
            background-color:#ffff00;
            font-family:verdana,helvetica,sans-serif;
          }
          .sourceText
          {
            display:block;
            color:#636363;
            font-style:italic;
          }
          .table, th, td
          {
            border: 1px solid black;
            border-collapse: collapse;
          }
          th,td
          {
            padding: 10px;
          }
        </style>
      </head>
      <body>
        <h2>MDL Validation Report</h2>
        <p>Timestamp: <xsl:value-of select="Timestamp" /></p>
        <p>MDL Instance Document:<br></p>
          Name: <xsl:value-of select="MdlInstanceDocument/Name" /><br></br>
          Role ID: <xsl:value-of select="MdlInstanceDocument/RoleId"
/><br></br>
          Network Name: <xsl:value-of
select="MdlInstanceDocument/NetworkName" /><br></br>
          Configuration Version: <xsl:value-of
select="MdlInstanceDocument/ConfigurationVersion" /><br></br>
          Database ID: <xsl:value-of select="MdlInstanceDocument/DatabaseId"
/>
        </p>
        <p>Validation Environment:<br></br>
          Application Version: <xsl:value-of
select="ValidationEnvironment/AppVersion" /><br></br>
          Application Configuration: <xsl:value-of
select="ValidationEnvironment/AppConfiguration" />
        </p>

        <table class="table" width="100%">

```



```

<tr>
  <th>Number</th>
  <th>Level</th>
  <th>Description</th>
  <th>Context</th>
</tr>
<xsl:for-each select="Message">
  <xsl:variable name="index" select="position()" />
  <xsl:variable name="helperUri" select="helperUri" />
  <tr>
    <td><xsl:value-of select="$index"/></td>
    <td><b><xsl:value-of select="Level"/></b></td>
    <xsl:choose>
      <xsl:when test="$helperUri != ''">
        <td><a href="{ $helperUri }"><xsl:value-of
select="Description"/></a></td>
      </xsl:when>
      <xsl:otherwise>
        <td><xsl:value-of select="Description"/></td>
      </xsl:otherwise>
    </xsl:choose>
    <td>
      <table width="100%">
        <tr>
          <th>MDL ID</th>
          <th>Comment</th>
        </tr>
        <xsl:for-each select="Context">
          <tr>
            <td><xsl:value-of select="MdlId"/></td>
            <td><xsl:value-of select="Comment"/></td>
          </tr>
        </xsl:for-each>
      </table>
    </td>
  </tr>
</xsl:for-each>
</table>
</body>
</html>
</xsl:template>
</xsl:stylesheet>

```

### A.3. Example Schema for the MDL Validation Report

```

<?xml version="1.0" encoding="UTF-8"?>
<!--
  Example MDL Validation Report Schema 20150326
-->
<xsd:schema xmlns:xsd="http://www.w3.org/2001/XMLSchema"
xmlns="http://inetprogram.org/projects/VRL"
targetNamespace="http://inetprogram.org/projects/VRL"
elementFormDefault="qualified" attributeFormDefault="unqualified">
  <xsd:element name="VRLRoot" type="VRLRootType">
    </xsd:element>
    <xsd:complexType name="VRLRootType">
      <xsd:annotation>
        <xsd:documentation xml:lang="en">
          The Timestamp element, of type xsd:dateTime, describes the time the
          Validation Report was generated.
        </xsd:documentation><xsd:documentation xml:lang="en">
          The MdlInstanceDocument element, of type MdlInstanceDocumentType,
          describes the MDL Instance Document
          used to generate the Validation Report.
        </xsd:documentation><xsd:documentation xml:lang="en">
          The ValidationEnvironment element, of type ValidationEnvironmentType,
          describes the processing validation
          environment used when validating the MDL Instance Document.
        </xsd:documentation><xsd:documentation xml:lang="en">
          The Message element, of type MessageType, describes an individual
          message relating to the validation
          of the MDL Instance Document.
        </xsd:documentation>
      </xsd:annotation>
      <xsd:sequence>
        <xsd:element name="Timestamp" type="xsd:dateTime"/>
        <xsd:element name="MdlInstanceDocument"
type="MdlInstanceDocumentType"/>
        <xsd:element name="ValidationEnvironment"
type="ValidationEnvironmentType"/>
        <xsd:element name="Message" type="MessageType" minOccurs="0"
maxOccurs="unbounded"/>
      </xsd:sequence>
    </xsd:complexType>

    <xsd:complexType name="MdlInstanceDocumentType">
      <xsd:annotation>
        <xsd:documentation xml:lang="en">
          The MdlInstanceDocumentType is a container for describing an MDL
          Instance Document.
        </xsd:documentation><xsd:documentation xml:lang="en">
          The Name element, of type xsd:string, describes the name of the MDL
          Instance Document,
          typically associated with a file name.
        </xsd:documentation><xsd:documentation xml:lang="en">
          The RoleId element, of type xsd:token, along with the NetworkName
          element uniquely
          identifies the TMA in the MDL Instance Document.
        </xsd:documentation><xsd:documentation xml:lang="en">

```

The NetworkName element, of type xsd:token, along with the RoleId element uniquely identifies the TMA in the MDL Instance Document.

```
</xsd:documentation><xsd:documentation xml:lang="en">
```

The ConfigurationVersion element, of type xsd:string, describes the MDL Instance Document's version number. The value was extracted from the MDL Instance Document.

```
</xsd:documentation><xsd:documentation xml:lang="en">
```

The DatabaseId element, of type xsd:string, describes the database used to generate the MDL Instance Document. The value was extracted from the MDL Instance Document.

```
</xsd:documentation>
</xsd:annotation>
<xsd:sequence>
  <xsd:element name="Name" type="xsd:string"/>
  <xsd:element name="RoleId" type="xsd:token"/>
  <xsd:element name="NetworkName" type="xsd:token"/>
  <xsd:element name="ConfigurationVersion" type="xsd:string"/>
  <xsd:element name="DatabaseId" type="xsd:string"/>
</xsd:sequence>
</xsd:complexType>
```

```
<xsd:complexType name="ValidationEnvironmentType">
  <xsd:annotation>
    <xsd:documentation xml:lang="en">
      The ValidationEnvironmentType is a container for describing the
      processing validation environment used when validating the MDL Instance Document.
    </xsd:documentation><xsd:documentation xml:lang="en">
      The AppVersion element, of type xsd:string, describes the validation
      application's version.
    </xsd:documentation><xsd:documentation xml:lang="en">
      The AppConfig element, of type xsd:string, describes the
      configuration of the validation application.
    </xsd:documentation>
  </xsd:annotation>
  <xsd:sequence>
    <xsd:element name="AppVersion" type="xsd:string"/>
    <xsd:element name="AppConfiguration" type="xsd:string"/>
  </xsd:sequence>
</xsd:complexType>
```

```
<xsd:complexType name="MessageType">
  <xsd:annotation>
    <xsd:documentation xml:lang="en">
      The MessageType is a container for describing a single validation
      message.
    </xsd:documentation><xsd:documentation xml:lang="en">
      The Level element, of type LevelEnumType, describes the type of
      validation message.
    </xsd:documentation><xsd:documentation xml:lang="en">
      The Description element, of type DescriptionType, contains the
      message's description.
    </xsd:documentation><xsd:documentation xml:lang="en">
```

The HelperUri element, of type xsd:anyURI, describes a link to more information

that might assist with understanding or resolving the issue identified in the message.

```
</xsd:documentation><xsd:documentation xml:lang="en">
```

The Context element, of type ConDescriptionType, describes the context of message.

```
</xsd:documentation>
```

```
</xsd:annotation>
```

```
<xsd:sequence>
```

```
<xsd:element name="Level" type="LevelEnumType"/>
```

```
<xsd:element name="Description" type="DescriptionType"/>
```

```
<xsd:element name="HelperUri" type="xsd:anyURI" minOccurs="0"/>
```

```
<xsd:element name="Context" type="ConDescriptionType"
maxOccurs="unbounded"/>
```

```
</xsd:sequence>
```

```
</xsd:complexType>
```

```
<xsd:complexType name="ConDescriptionType">
```

```
<xsd:annotation>
```

```
<xsd:documentation xml:lang="en">
```

The ConDescriptionType is a container for describing the context of a validation message.

```
</xsd:documentation><xsd:documentation xml:lang="en">
```

The MdlId element, of type xsd:ID, describes the MDL Instance Document's ID referenced by

this validation message. Note: if there is no applicable ID reference, this value is set

```
to 'none'.
```

```
</xsd:documentation><xsd:documentation xml:lang="en">
```

The Comment element, of type DescriptionType, describes the location of the validation message

```
(human readable description).
```

```
</xsd:documentation>
```

```
</xsd:annotation>
```

```
<xsd:sequence>
```

```
<xsd:element name="MdlId" type="xsd:ID"/>
```

```
<xsd:element name="Comment" type="DescriptionType" minOccurs="0"/>
```

```
</xsd:sequence>
```

```
</xsd:complexType>
```

```
<xsd:simpleType name="LevelEnumType">
```

```
<xsd:annotation>
```

The LevelEnumType contains a list of message levels:

```
</xsd:documentation><xsd:documentation>
```

```
Info: General information that has no bearing on the validity of the MDL Instance Document.
```

```
</xsd:documentation><xsd:documentation>
```

Warning: Potential issue with specified element(s). A warning will not invalidate

an MDL Instance Document but the validated document may not achieve the desired

```
configuration.
```

```
</xsd:documentation><xsd:documentation>
```

Error: Invalid or incorrectly specified element(s). An error indicates the

```
    MDL Instance Document is invalid.
  </xsd:documentation>
</xsd:annotation>
<xsd:restriction base="xsd:string">
  <xsd:enumeration value="INFO"/>
  <xsd:enumeration value="WARNING"/>
  <xsd:enumeration value="ERROR"/>
</xsd:restriction>
</xsd:simpleType>

<xsd:complexType name="DescriptionType">
  <xsd:annotation>
    <xsd:documentation>The DescriptionType describes a language-based
string container.</xsd:documentation>
  </xsd:annotation>
  <xsd:simpleContent>
    <xsd:extension base="xsd:string">
      <xsd:attribute name="lang" type="xsd:language" default="en"/>
    </xsd:extension>
  </xsd:simpleContent>
</xsd:complexType>

</xsd:schema>
```

This page intentionally left blank.

## APPENDIX 25-B

### Citations

- Internet Engineering Task Force. “Definitions of Managed Objects for Bridges.” RFC 4188. September 2005. May be superseded or amended by update. Retrieved 17 May 2021. Available at <https://datatracker.ietf.org/doc/rfc4188/>.
- . “The Interface Group MIB.” RFC 2863. June 2000. May be superseded or amended by update. Retrieved 17 May 2021. Available at <https://datatracker.ietf.org/doc/rfc2863/>.
- . “Management Information Base for the Internet Protocol (IP).” RFC 4293. April 2006. May be superseded or amended by update. Retrieved 17 May 2021. Available at <https://datatracker.ietf.org/doc/rfc4293/>.
- . “Management Information Base (MIB) for the Simple Network Management Protocol (SNMP).” RFC 3418. December 2002. May be superseded or amended by update. Retrieved 17 May 2021. Available at <https://datatracker.ietf.org/doc/rfc3418/>.
- . “Management Information Base for the Transmission Control Protocol (TCP).” RFC 4022. March 2005. May be superseded or amended by update. Retrieved 17 May 2021. Available at <https://datatracker.ietf.org/doc/rfc4022/>.
- . “Management Information Database for the User Datagram Protocol (UDP).” RFC 4113. June 2005. May be superseded or amended by update. Retrieved 17 May 2021. Available at <https://datatracker.ietf.org/doc/rfc4113/>.
- . “Simple Network Management Protocol (SNMP) Applications.” RFC 3413. December 2002. May be superseded or amended by update. Retrieved 17 May 2021. Available at <https://datatracker.ietf.org/doc/rfc3413/>.
- . “Textual Conventions for SMIV2.” RFC 2579. April 1999. May be superseded or amended by update. Retrieved 17 May 2021. Available at <https://datatracker.ietf.org/doc/rfc2579/>.
- . “URN Syntax.” RFC 2141. Obsoleted by RFC 8141. May 1997. Retrieved 17 May 2021. Available at <https://datatracker.ietf.org/doc/rfc2141/>.

**\*\*\*\* END OF CHAPTER 25 \*\*\*\***



## CHAPTER 26

### TmNSDataMessage Transfer Protocol

Acronyms .....	26-iii
<b>Chapter 26. TmNSDataMessage Transfer Protocol .....</b>	<b>26-1</b>
<b>26.1 General.....</b>	<b>26-1</b>
<b>26.2 Data Channel Characteristics .....</b>	<b>26-2</b>
26.2.1 Network Transport Characteristics .....	26-2
26.2.2 Message List .....	26-3
26.2.3 Time Range.....	26-3
<b>26.3 Metadata-Defined Application Data Transfer .....</b>	<b>26-3</b>
26.3.1 Latency/Throughput Critical (LTC) Delivery Protocol.....	26-3
26.3.2 LTC Delivery Protocol Data Channel (LTCDataChannel) .....	26-3
<b>26.4 Request-Defined Application Data Transfer .....</b>	<b>26-4</b>
26.4.1 Real Time Streaming Protocol (RTSP)-based Control Channel ( <i>RTSPControlChannel</i> ).....	26-4
26.4.2 RTSP-Based Data Channel ( <i>RTSPDataChannel</i> ).....	26-13
26.4.3 Reliability Critical (RC) Delivery Protocol .....	26-14
26.4.4 Request-Defined Data Channel.....	26-14
<b>26.5 TmNSDataMessage Transfer Rules .....</b>	<b>26-14</b>
26.5.1 Sequence Numbering Convention .....	26-15
26.5.2 Timestamp Convention.....	26-15
26.5.3 TmNSDataMessage Fragmentation .....	26-15
26.5.4 Generating <i>TmNSDataMessages</i> from Other <i>TmNSDataMessages</i> Convention.....	26-16
<b>Appendix 26-A. Citations .....</b>	<b>A-1</b>

### List of Figures

Figure 26-1. Unicast DataChannel .....	26-1
Figure 26-2. Multicast or Broadcast DataChannel .....	26-1
Figure 26-3. Request-Defined Data Channel.....	26-2

### List of Tables

Table 26-1. Required RTSP Header.....	26-4
---------------------------------------	------

This page intentionally left blank.

## Acronyms

DSCP	Differentiated Services Code Point
IP	Internet Protocol
LTC	Latency/Throughput Critical
MDL	Metadata Description Language
PTP	Precision Time Protocol
RFC	Request for Comment
RTSP	Real Time Streaming Protocol
SMPTE	Society of Motion Picture and Television Engineers
TCP	Transmission Control Protocol
TmNS	Telemetry Network Standard
UDP	User Datagram Protocol
URI	uniform resource indicator

This page intentionally left blank.

## CHAPTER 26

### TmNSDataMessage Transfer Protocol

#### 26.1 General

This chapter defines how Telemetry Network Standard (TmNS)-specific data (*TmNSDataMessages*) are transferred between applications. A *DataSource* shall transmit *TmNSDataMessages* and a *DataSink* shall receive *TmNSDataMessages*. A *DataChannel* identifies a logical network connection used to transfer *TmNSDataMessages* between a *DataSource* and *DataSink*.

A unicast *DataChannel* is a logical network connection between a single *DataSource* and a single *DataSink*, as shown in [Figure 26-1](#).

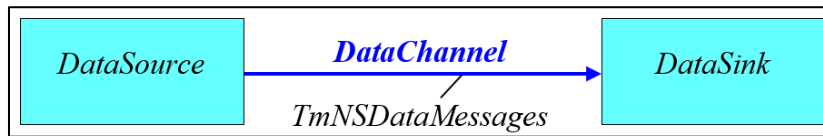

Figure 26-1. Unicast DataChannel

A multicast or broadcast *DataChannel* is a logical network connection between a single *DataSource* and one or more *DataSinks*, as shown in [Figure 26-2](#).

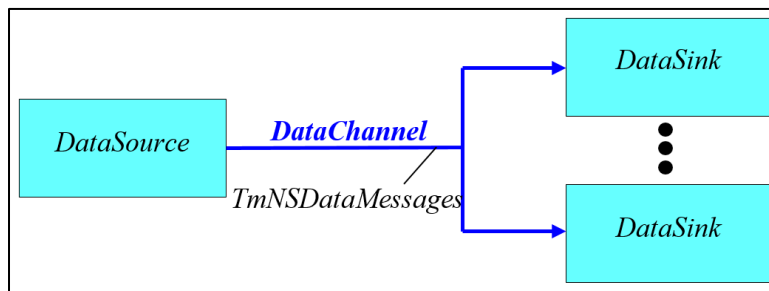

Figure 26-2. Multicast or Broadcast DataChannel

This document describes how *DataChannels* are allocated and managed via application data transfer resources. [Chapter 25](#) defines the associated management resources. [Chapter 21](#) Appendix 21-B describes the bit numbering, bit ordering, and byte ordering conventions used in this chapter.

A *DataChannel* may be established by submitting a *ResourceRequest* to specific application data transfer resources or via metadata (i.e., described in a Metadata Description Language [MDL] instance document). This is shown in [Figure 26-3](#).

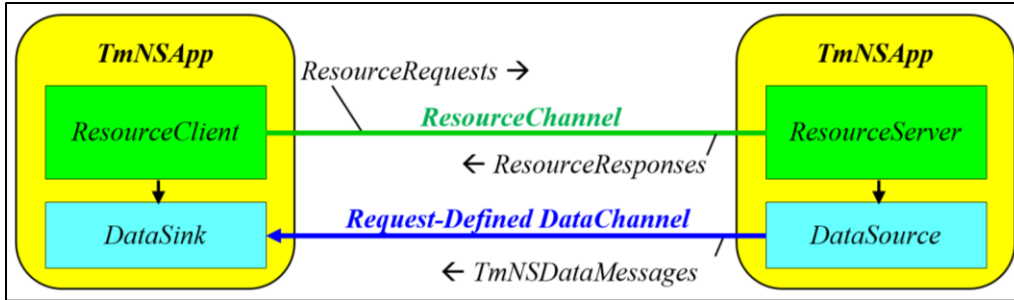

Figure 26-3. Request-Defined Data Channel

## 26.2 Data Channel Characteristics

The following information describes a *DataChannel*:

- Network Transport Characteristics
- Message List
- Time Range

### 26.2.1 Network Transport Characteristics

*TmNSDataMessages* shall be transported using either the User Data Protocol (UDP) or the Transmission Control Protocol (TCP). A *DataChannel* shall support a single Differentiated Services Code Point (DSCP) assignment as specified in the Quality of Service section of [Chapter 22](#).

For a metadata-defined *DataChannel*, the network transport characteristics are specified in an MDL instance document. See Section [26.3](#) for more information.

For a request-defined *DataChannel*, the network transport characteristics are included in the *ResourceRequest*. See Section [26.4](#) for more information.

#### 26.2.1.1 UDP DataChannel

All UDP-capable *DataSources*:

- shall support sending *TmNSDataMessages* via UDP/Internet Protocol (IP) multicast, as specified in [Chapter 22](#);
- should support sending *TmNSDataMessages* via UDP/IP unicast or broadcast, as specified in [Chapter 22](#);
- shall send one complete *TmNSDataMessage* or *TmNSDataMessage* fragment per UDP datagram.

 <p><b>NOTE</b></p>	<p>It is anticipated that a future version of this chapter may allow for multiple <i>TmNSDataMessages</i> to be delivered in a single UDP datagram.</p>
--	---

All UDP-capable *DataSinks*:

- shall support receiving *TmNSDataMessages* via UDP/IP multicast, as specified in [Chapter 22](#);

- should support receiving *TmNSDataMessages* via UDP/IP unicast or broadcast, as specified in [Chapter 22](#).

#### 26.2.1.2 TCP DataChannel

All TCP-capable *DataSources* shall support sending *TmNSDataMessages* via TCP/IP, as specified in [Chapter 22](#).

All TCP-capable *DataSinks* shall support receiving *TmNSDataMessages* via TCP/IP, as specified in [Chapter 22](#).

#### 26.2.2 Message List

A *TmNSDataMessage* List nominally contains a list of *MessageDefinitionIDs* and identifies which *TmNSDataMessages* shall be transported across the *DataChannel*.

For a request-defined *DataChannel*, the *TmNSDataMessage* list is included in the *ResourceRequest*.

For a metadata-defined *DataChannel*, the *TmNSDataMessage* list is defined in an MDL instance document. See Section [26.3](#) for more information.

#### 26.2.3 Time Range

A time range is comprised of a start time and end time where each time specifies one of the following:

- Past time: associated with retrieving data with timestamps before the current time;
- Present time: associated with current acquisition (e.g., live) data;
- Future time: associated with future acquisition data.

For a request-defined *DataChannel*, the time range shall be included in the *ResourceRequest*. Time ranges with various combinations of past, present, and future time are supported provided the end time is greater than the start time.

### 26.3 Metadata-Defined Application Data Transfer

Metadata-defined Application Data Transfer refers to the *TmNS*-specific application-level method of delivering *TmNSDataMessages* using an MDL instance document to specify *DataChannel* characteristics.

Metadata-defined *DataChannels* are opened at *TmNSApp* startup/reconfiguration and remain open indefinitely.

#### 26.3.1 Latency/Throughput Critical (LTC) Delivery Protocol

The LTC Delivery Protocol is the *TmNS*-specific application-level method of delivering *TmNSDataMessages* via UDP.

#### 26.3.2 LTC Delivery Protocol Data Channel (LTCDataChannel)

*LTCDataSources* and *LTCDataSinks* shall support UDP Data Channels as defined in Subsection [26.2.1.1](#)

*LTCDataSources* shall transport *TmNSDataMessages* using the UDP destination address and port determined by the following descending order of precedence.

1. The address and port associated with the *MDID* of the delivered *TmNSDataMessage* in the MDL instance document. If only the address is available, the default port is port 55555.
2. The broadcast IP address and port 55555.

*LTCDataSources* and *LTCDataSinks* shall comply with the standard *TmNSDataMessage* structure and mechanisms as specified in [Chapter 24](#).

## 26.4 Request-Defined Application Data Transfer

Request-defined Application Data Transfer refers to the *TmNS*-specific application-level method of delivering *TmNSDataMessages* via a *ResourceClient*'s data request (*DataRequest*).

### 26.4.1 Real Time Streaming Protocol (RTSP)-based Control Channel (*RTSPControlChannel*)

*DataSources* and *DataSinks* (referred to as *RTSPDataSources* and *RTSPDataSinks* respectively) using the *RTSPControlChannel* shall exchange control commands and parameters using RTSP, as specified in Request for Comment (RFC) 2326.<sup>1</sup>

*RTSPDataSources* and *RTSPDataSinks* shall transport RTSP commands in the *RTSPControlChannel* using TCP.

The *RTSPDataSink* shall act as the RTSP client and the *RTSPDataSource* shall act as the RTSP server.

The RTSP server shall listen for a TCP connection on the TCP port specified in the **ListeningPort** element under the **TmNSRCDDataSource** element in the MDL instance document. If no port is specified, then port 55554 shall be used.

The RTSP client shall establish an *RTSPControlChannel* using the TCP port specified in the **ListeningPort** element under the selected **TmNSRCDDataSource** element in the MDL instance document. If no port is specified, then port 55554 shall be used.

The *RTSPControlChannel* shall use the same DSCP in both directions based on the DSCP selected at origination of the *RTSPControlChannel* by the *RTSPDataSink*.

When an *RTSPDataSource* cannot perform in the manner specified in this standard, the *RTSPDataSource* shall issue the appropriate error Status-Code specified in RFC 2326.

An *RTSPDataSource* shall return all *TmNSDataMessages* that match a particular *TmNS\_Request\_Defined\_URI* request and shall include an End of Data Indication (see Subsection [26.4.2.2](#)).

The *RTSPControlChannel* shall support the following RTSP commands: “OPTIONS” “SETUP,” “TEARDOWN,” “PLAY,” and “PAUSE” methods. [Table 26-1](#) identifies the required RTSP headers for the mandatory RTSP methods.

Table 26-1. Required RTSP Header			
Header	Type	Methods	Comment
Bandwidth	Request	PLAY	See Subsection <a href="#">26.4.1.3</a> for details.

<sup>1</sup> Internet Engineering Task Force. “Real Time Streaming Protocol (RTSP).” RFC 2326. Obsoleted by RFC 7826. April 1998. Retrieved 17 May 2021. Available at <https://datatracker.ietf.org/doc/rfc2326/>.



Connection	Request Response	ALL	Only applicable connection token is “close”.
CSeq	Request Response	ALL	
Public	Response	OPTIONS	Only used in response to an OPTION request.
Range	Request Response	PLAY	See Subsection <a href="#">26.4.1.2</a> for details.
Session	Request Response	PLAY, PAUSE, TEARDOWN	
Speed	Request	PLAY	See Subsection <a href="#">26.4.1.3</a> for details.
Transport	Request Response	SETUP	See Subsection <a href="#">26.4.1.1</a> for details.

All RTSP clients and servers may support additional RTSP commands and associated header fields as specified in Request for Comment (RFC) 2326.

#### 26.4.1.1 Transport Header

The RTSP transport header shall be supported by *RTSPDataSources* and *RTSPDataSinks* using the *RTSPControlChannel*. The transport header indicates which transport protocol is to be used and configures its parameters, such as destination address, multicast time-to-live, and destination port. A transport request header field may contain a list of transport options acceptable to the client. Transport options are comma-separated, listed in order of preference. Parameters may be added to each transport option, separated by a semicolon. All *RTSPDataSources* and *RTSPDataSinks* shall support the following transport header parameters.

```

Transport          = "Transport" ":"
                   1\#transport-spec
transport-spec     = transport-protocol/profile[/lower-transport]
                   *parameter
transport-protocol = "TMNS"
profile            = "TMNSP"
lower-transport    = "TCP" | "UDP"
parameter          = ( "unicast" | "multicast" )
                   | ";" "destination" [ "=" address ]
                   | ";" "ttl" "=" ttl
                   | ";" "client_port" "=" port [ "-" port ]
ttl                = 1*3 (DIGIT)
port               = 1*5 (DIGIT)
address            = host

```



This standard deviates from RFC 2326 (which states that a lower-transport protocol of “TCP” results in interleaving user-request data onto the *RTSPControlChannel*) by interpreting the lower-transport protocol of “TCP” as requiring a separate TCP data channel (not an interleaved control+data channel). See Subsection [26.4.2](#).

### 26.4.1.2 Range Header

The following Precision Time Protocol (PTP) Time Range format shall be supported in the Range Header by *RTSPDataSources* and *RTSPDataSinks* using the *RTSPControlChannel*.

```
ptp-range      = "ptp-clock" "=" ptp-startTime "-" [ ptp-endTime ]
ptp-startTime = "start" | "now" | TmNSTimestamp*
ptp-endTime   = "end"   | "now" | TmNSTimestamp*
```

\*TmNSTimestamp format is defined in [Chapter 22](#) Subsection 22.5.1.3.6.

The following rules shall be supported for the PTP time range.

- If a ptp-endTime is specified, then the ptp-endTime shall be greater than the ptp-startTime.
- A “start” constant shall be interpreted as the earliest **MessageTimestamp** of all available *TmNSDataMessages*.  
A “now” or “end” constant shall be interpreted as inclusive of the latest **MessageTimestamp** of all available *TmNSDataMessages* at the receipt of the request.
- Not specifying a ptp-endTime or specifying a ptp-endTime that exceeds the latest **MessageTimestamp** of all available *TmNSDataMessages* results in the *RTSPDataSource* transmitting data from the ptp-startTime to the last available requested *TmNSDataMessage* and then continually transmitting received requested *TmNSDataMessages* until one of the following conditions occurs:
  - The ptp-endTime is specified and the **MessageTimestamp** of a received requested *TmNSDataMessage* is equal to or exceeds the specified ptp-endTime;
  - A TEARDOWN is executed;
  - The TCP-based *RCDDataChannel* is closed;
 For all of the above conditions except the *RCDDataChannel* closure, the *RTSPDataSource* shall transmit an End of Data Indication (see Subsection [26.4.2.2](#)) prior to closing the *RCDDataChannel*.
- Requests with no ptp-endTime shall remain active until a TEARDOWN is executed.
- If no *TmNSDataMessages* are available, the *DataSource* shall return a status code of 412 (“Precondition Failed”) except in the case where the ptp-startTime is set to “start” or “end” and the ptp-endTime is not set.
- If a time range specification does not satisfy the aforementioned rules, the *RTSPDataSource* shall return a status code of 457 (“Invalid Range”).

To support *TmNSDataMessage*’s native Message Timestamp format, *RTSPDataSources* and *RTSPDataSinks* implementing the *RTSPControlChannel* shall support the following modifications to RFC 2326, Section 12.29 (“Range”):

1. The PTP Time Range format shall be supported;

2. The Network Time Protocol and Universal Coordinated Time time range formats may be supported;
3. The “time=” option may be supported with the addition of the PTP time range format.

```

Range                = "Range" ":" 1\#ranges-specifier
                    [ ";" "time" "=" utc-time | TmNSTimestamp1 ]
ranges-specifier    = npt-range | utc-range | smpte-range | ptp-range1
    
```

<sup>1</sup> Bold items are new; the remaining items are defined in RFC 2326.

If the RTSP Range header is not specified, then data shall be supplied as though a “start” constant was given for the `ptp-startTime`, an “end” constant was given for the `ptp-endTime`, and no value for the “time” option was given.

The RTSP Range header represents only a request for a time range, and standard errors should be returned when requests cannot be serviced or in-progress connections fail.

 <p><b>NOTE</b></p>	<p>Use of Society of Motion Picture and Television Engineers (SMPTE) relative timestamps in the RTSP Range header is not recommended. The SMPTE timestamps are intended for video clips and the format (“hours:minutes:seconds:frames.subframes”) does not clearly map to time range selection based on <i>TmNSDataMessage</i> <b>MessageTimestamp</b> values.</p>
--	--

 <p><b>NOTE</b></p>	<p>The inclusiveness and exclusiveness of range intervals is specified in Section 12.29 of RFC 2326.</p>
--	--

*RTSPDataSources* and *RTSPDataSinks* shall interpret `ptp-startTime` and `ptp-endTime` values as measurement time, not as message time.

 <p><b>NOTE</b></p>	<p>The start and end time values must be interpreted as measurement time and not message time in order to ensure all requested data is returned. A message may contain data for a time range, not just a single time as specified by the message’s <b>MessageTimestamp</b>.</p>
--	---

The first *TmNSDataMessage* returned for a specified `ptp-startTime` shall be the requested *TmNSDataMessage* with the latest **MessageTimestamp** that is less than or equal to the `ptp-startTime`.

If the `ptp-startTime` precedes the earliest available requested *TmNSDataMessage*’s **MessageTimestamp**, the earliest requested *TmNSDataMessage* shall be the first *TmNSDataMessage* returned.

### 26.4.1.3 Bandwidth and Speed Headers

The RTSP Speed header shall be supported by *RTSPDataSources* using the *RTSPControlChannel*.

The RTSP Speed header should be supported by *RTSPDataSinks* using the *RTSPControlChannel*.

For the RTSP Speed header, normal speed (1.0) shall be defined as the rate at which *TmNSDataMessage* MessageTimestamp values progress.

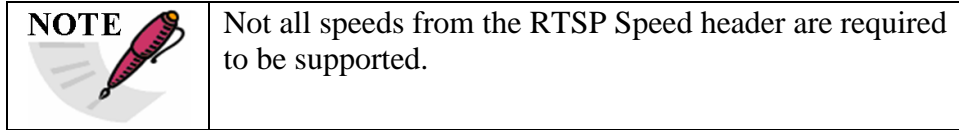

The RTSP Bandwidth header shall be supported by *RTSPDataSources* using the *RTSPControlChannel*.

The RTSP Bandwidth header should be supported by *RTSPDataSinks* using the *RTSPControlChannel*.

If the RTSP Speed and Bandwidth headers are not specified, then data shall be supplied as fast as possible, as regulated by the resources between the *RTSPDataSource* and the *RTSPDataSink*.

*RTSPDataSinks* shall not specify both the RTSP Speed and Bandwidth headers in the same request.

#### 26.4.1.4 Request-Defined Uniform Resource Indicator (URI) Syntax

The RTSP methods used in the *RTSPControlChannel* shall use the *TmNS\_Request\_Defined\_URI* to request specific data from an *RTSPDataSource*. The *TmNS\_Request\_Defined\_URI* shall use the generic syntax for URIs as specified in [Chapter 22](#) as specialized below.

**TmNS\_Request\_Defined\_URI =**

```
"rtsp://" TmNShost [ ":" TmNShostport ] "/" "TmNS" "/" TmNSversion "/"
[ TmNSlist "/" ] [ TmNSdestIP [ ":" TmNSdestport ] "/" ]
[ "-" TmNSplaybackopt "/" ] [ "-" TmNStimeopt "/" ]
[ "/" TmNSdeliveryDSCP ]
```

```
TmNShost           = TmNShostname | TmNSIPv4address
TmNShostname       = *( TmNSdomainlabel "." ) TmNSstoplabel [ "." ]
TmNSdomainlabel    = TmNSalphanum | TmNSalphanum *( TmNSalphanum | "-" ) TmNSalphanum
TmNSstoplabel      = ALPHA | ALPHA *( TmNSalphanum | "-" ) TmNSalphanum
TmNSIPv4address    = 1*DIGIT "." 1*DIGIT "." 1*DIGIT "." 1*DIGIT
TmNShostport       = 1*DIGIT
TmNSdeliveryDSCP   = 1*DIGIT
```

```
TmNSversion        = "1.0"
```

```
TmNSlist           = (1*TmNSmididlist) | (1*(TmNSpdidlist ">" TmNSdeliverymidid) |
(1*(TmNSmeasidlist ">" TmNSdeliverymidid "<" TmNSdeliverypidid ))
```

```

TmNSmdidlist      = 1*( "&" TmNSmdid [ "-" TmNSmdid ] )
TmNSmdid          = 1*DIGIT

TmNSpdidlist     = 1*( TmNSmdidlist 1*( "@" TmNSpdid [ "-" TmNSpdid ] ) )
TmNSpdid         = 1*DIGIT

TmNSmeasidlist   = 1*( TmNSpdidlist 1*( "#" TmNSmeasid [ "-" TmNSmeasid ] ) )
TmNSmeasid       = 1*DIGIT

TmNSdestIP       = 1*DIGIT "." 1*DIGIT "." 1*DIGIT "." 1*DIGIT
TmNSdestport     = 1*DIGIT
TmNSdeliverymdid = 1*DIGIT
TmNSdeliverypdid = 1*DIGIT

TmNSplaybackopt  = "l" | "p" ; "l" = marked as live data in MessageFlags
                  ; "p" = marked as playback data in MessageFlags
                  ; default is "p" if not provided

TmNStimeopt      = "o" | "c" ; "o" = original timestamps
                  ; "c" = timestamps based on RTSPDataSource current time
                  ; default is "o" if not provided

TmNSalphanum     = ALPHA | DIGIT

```

All numeric fields of the *TmNS\_Request\_Defined\_URI* shall be interpreted as decimal.

The **TmNShost** and optional **TmNShostport** values shall indicate the IPv4 address and port of the *RTSPDataSource*.

The optional **TmNSdeliveryDSCP** specifies the DSCP marking to which requested *TmNSDataMessages* shall be sent. If the **TmNSdeliveryDSCP** is not specified, the *RTSPDataSource* shall mark all delivered IP packages with the “Best Effort” marking.

A **TmNSlist** that contains a **TmNSmdidlist** shall indicate a *MessageDefinitionID* request type according to Subsection [26.4.1.5.1](#). A request that does not include the **TmNSlist** shall indicate a *MessageDefinitionID* request for all *MessageDefinitionIDs*.

A **TmNSlist** that contains a **TmNSpdidlist** shall indicate a *PackageDefinitionID* request type according to Subsection [26.4.1.5.2](#).

A **TmNSlist** that contains a **TmNSmeasidlist** shall indicate a *MeasurementID* request type according to Subsection [26.4.1.5.3](#).

**TmNSmdid** values separated by a “-” shall indicate a request for an inclusive range of *MDIDs* between the first and last **TmNSmdid** values specified.

**TmNSpdid** values separated by a “-” shall indicate a request for an inclusive range of *PDIDs* between the first and last **TmNSpdid** values specified.

**TmNSmeasid** values separated by a “-” shall indicate a request for an inclusive range of *MeasurementIDs* between the first and last **TmNSmeasid** values specified.

For all request types:

- If present, the `TmNSdestIP ":" TmNSdestport` value shall indicate the IPv4 address and port to which requested *TmNSDataMessages* shall be sent.
- If present, the **TmNSplaybackopt** value indicates:
  - The *PlaybackDataFlag* shall be set to 1'b0 when the value is “l”;
  - The *PlaybackDataFlag* shall be set to 1'b1 when the value is “p”;

If the `TmNSplaybackopt` is not present, the *PlaybackDataFlag* shall be set to 1'b0.

- If present, the **TmNStimeopt** value indicates:
  - The *TmNSDataMessage* Message Timestamps shall be the original timestamp when the value is “o”
  - The *TmNSDataMessage* Message Timestamps shall be based on the *RTSPDataSource*'s current time when the value is “c”
  - If the **TmNStimeopt** is not present, the *TmNSDataMessage* Message Timestamps shall be the original timestamp.
- When requesting *Packages* without standard *PackageHeaders* to be delivered using *Packages* with standard *PackageHeaders*, the time expressed using the delivery **MessageTimestamp** and delivery *PackageTimeDelta* shall be equivalent to the time expressed by the requested **MessageTimestamp**.

 <p><b>NOTE</b></p>	<p>As noted in RFC 2068<sup>2</sup>, “servers should be cautious about depending on URI lengths above 255 bytes because some older client or proxy implementations may not properly support these lengths.” The appropriate error status code specified in RFC 2326 for “Request-URI Too Large” is “414”.</p>
--	---

#### 26.4.1.5 Request Types

*RTSPDataSources* shall return valid *TmNSDataMessages* based on the particular request type as described in the following sections.

If none of the requested *MessageDefinitionIDs* are defined in an *RCDDataSource*'s *RCDDataSource* list, the *RCDDataSource* shall return a status code of 412 (“Precondition Failed”).

If no *TmNSDataMessages* are available on the *RTSPDataSource* for all requested *MessageDefinitionIDs*, the *RTSPDataSource* shall transmit an End of Data Indication (see Subsection [26.4.2.2](#)) prior to closing the *RCDChannel*.

 <p><b>NOTE</b></p>	<p>Since the <i>RTSPDataSource</i> returns ALL data that match its request criteria, it is possible that the combination of a particular request and data present at an <i>RTSPDataSource</i> will result in duplicate data being returned. The</p>
--	---

<sup>2</sup> Internet Engineering Task Force. “Hypertext Transfer Protocol – HTTP/1.1.” RFC 2068. Obsoleted by RFC 2616. January 1997. Retrieved 17 May 2021. Available at <https://datatracker.ietf.org/doc/rfc2068/>.

	possibility of this data duplication can be reduced or eliminated by generating a more specific request.
--	--

#### 26.4.1.5.1 *MessageDefinitionID Request (TmNSmdid)*

*RTSPDataSources* processing a *MessageDefinitionID* request shall adhere to the following requirements.

- All *TmNSDataMessages* matching the requested *MessageDefinitionID(s)* within the timeframe specified shall be delivered.
- Delivered *TmNSDataMessages* shall be labeled with the original *MessageDefinitionID(s)*.
- The delivered *TmNSDataMessages* Message Timestamp value is governed by the presence or absence of the **TmNStimeopt** value in the *TmNS\_Request\_Defined\_URI*.
- Delivered *TmNSDataMessages* shall retain the **ApplicationDefinedFields**, **MessageFlags**, and **StatusFlags** fields from the original *TmNSDataMessages*.

#### 26.4.1.5.2 *PackageDefinitionID Request (TmNSpdid)*

*RTSPDataSources* processing a *PackageDefinitionID* request shall adhere to the following requirements.

- Valid *TmNSDataMessages* shall be delivered containing the original *Packages* matching the requested *PackageDefinitionID(s)*. Instances of the *Packages* to be delivered may be refined through the specification of *MessageDefinitionIDs*; otherwise, ALL instances of the *Packages* within the timeframe specified shall be delivered.
- Delivered *TmNSDataMessages* shall be labeled with the *MessageDefinitionID* set to the value specified in **TmNSdeliverymdid**.
- Delivered *TmNSDataMessages* shall follow the requirements in Subsection [26.5.4](#) for handling *MessageFlags* fields.
- Any *ApplicationDefinedFields* in the delivered *TmNSDataMessages* shall indicate conditions on the *RTSPDataSource* delivering the *TmNSDataMessages*, not the original *RTSPDataSource*.

##### 26.4.1.5.2.1 *PackageDefinitionID Request Standard PackageHeader Handling*

*RTSPDataSources* processing a *PackageDefinitionID* request shall deliver all requested *Packages* from original *Packages* that use the standard *PackageHeader*.

##### 26.4.1.5.2.2 *PackageDefinitionID Request Non-Standard PackageHeader Handling*

*RTSPDataSources* processing a *PackageDefinitionID* request and that support extraction from *Packages* that do not use the standard *PackageHeader* shall deliver all requested *Packages* from original *Packages* that do not use the standard *PackageHeader*.

#### 26.4.1.5.3 *MeasurementID Request (TmNSmeasid)*

*RTSPDataSources* processing a *MeasurementID* request shall adhere to the following requirements.

- Valid *TmNSDataMessages* shall be delivered containing *Packages* with the *MeasurementData* matching the requested *MeasurementID(s)*. Instances of the

*MeasurementData* to be delivered may be refined through the specification of *MessageDefinitionIDs* and/or *PackageDefinitionIDs*; otherwise, ALL instances of *MeasurementData* within the timeframe specified shall be delivered.

- Delivered *TmNSDataMessages* shall be labeled with the *MessageDefinitionID* field in the *TmNSDataMessageHeader* set to the value specified in **TmNSdeliverypdid**.
- Delivered *TmNSDataMessages* shall contain *Packages* according to the *PackageDefinition* corresponding to the **TmNSdeliverypdid**.
- Delivered *TmNSDataMessages* shall follow the requirements in Subsection [26.5.4](#) for handling **MessageFlags** fields.
- Any **ApplicationDefinedFields** in the delivered *TmNSDataMessages* shall indicate conditions on the *RTSPDataSource* delivering the *TmNSDataMessages*, not the original *RTSPDataSource*.
- A requested *Package* containing the requested *MeasurementData* shall have one and only one corresponding delivery *Package*.

#### 26.4.1.5.3.1 MeasurementID Request Standard PackageHeader Handling

*RTSPDataSources* processing a *MeasurementID* request shall adhere to the following requirements.

- The *RTSPDataSource* shall deliver all requested *MeasurementData* from original *Packages* that use the standard *PackageHeader*.
- For each original *Package* that uses the standard *PackageHeader*, the corresponding *Package* in the delivered *TmNSDataMessage* shall have a *Package Time* equal to the *Package Time* of the original *Package* according to the *PackageDefinition* corresponding to the **TmNSdeliverypdid**.

#### 26.4.1.5.3.2 MeasurementID Request Non-Standard PackageHeader Handling

*RTSPDataSources* processing a *MeasurementID* request and that support extraction from *Packages* that do not use the standard *PackageHeader* shall adhere to the following requirements.

- The *RTSPDataSource* may deliver some or all requested *MeasurementData* from original *Packages* that do not use the standard *PackageHeader*.
- For each original *Package* that does not use the standard *PackageHeader*, the corresponding *Package* in the delivered *TmNSDataMessage* shall have a *Package Time* equal to the *Message Time* of the original *Package* according to the *PackageDefinition* corresponding to the **TmNSdeliverypdid**.

**NOTE**



A more accurate timestamp can be used through a custom *PackageHeader* if one is available; however, interoperability should still be maintained without the use of a custom *PackageHeader* timestamp.



### 26.4.2 RTSP-Based Data Channel (*RTSPDataChannel*)

The operation of the *RTSPDataChannel* shall be controlled by the *RTSPControlChannel* as specified in Subsection [26.4.1](#). The *RTSPDataChannel* transport protocol (TCP or UDP) is specified in the transport header of the *DataRequest*.

*RTSPDataChannel* messages shall use the standard *TmNSDataMessage* structure and mechanisms as specified in [Chapter 24](#).

Upon receipt of a valid SETUP request, an *RTSPDataSource* shall open the *RTSPDataChannel* socket.

Upon receipt of a valid PLAY request, an *RTSPDataSource* shall attempt to transmit requested data to the *RTSPDataChannel* socket.

Upon receipt of a TEARDOWN request, an *RTSPDataSource* shall close the *RTSPDataChannel* socket.

After receiving the TEARDOWN response, an *RTSPDataSink* shall close the *RTSPDataChannel* socket.

 <p><b>NOTE</b></p>	<p>Handling data loss on a <i>DataChannel</i> is not addressed by this standard.</p>
--	--

#### 26.4.2.1 TCP-Based *RTSPDataChannel*

Prior to issuing a SETUP request, an *RTSPDataSink* shall open the *RTSPDataChannel* socket. The *RTSPDataSink* shall execute a listen on the socket and optionally obtain an ephemeral TCP port number (which would be included in the transport header).

Upon receipt of a SETUP request, an *RTSPDataSource* shall execute a connect on the socket (the SETUP request's transport header contains the transport protocol information).

#### 26.4.2.2 End of Data Indication

When the *RTSPDataSource* is ready to close the *RTSPDataChannel*, it shall deliver an End of Data Indicator to the *RTSPDataSink*.

The *RTSPDataSource* may set the **EndOfDataFlag** in the *TmNSDataMessageHeader* of the last *TmNSDataMessage* prior to sending the last *TmNSDataMessage* to the *RTSPDataSink*. Alternatively, or if no *TmNSDataMessages* have been sent, the *RTSPDataSource* shall deliver a *TmNSDataMessage* with no *TmNSDataMessagePayload* and the following values in the *TmNSDataMessageHeader*:

- Set MessageFlags to 16'h0001, which sets only the EndOfDataFlag
- Set MessageDefinitionID to 32'd0.
- Set MessageDefinitionSequenceNumber to 32'd0.
- Set MessageLength to 32'd24.
- Set MessageTimestamp to 64'd0.

### 26.4.3 Reliability Critical (RC) Delivery Protocol

The RC Delivery Protocol is the *TmNS*-specific application-level method of delivering *TmNSDataMessages* via TCP.

 <p><b>NOTE</b></p>	<p>The RC Delivery Protocol section and all related subsections specify how to deliver <i>TmNSDataMessages</i> when reliability of data delivery is more important than low latency or high throughput.</p>
--	---

#### 26.4.3.1 RC Delivery Protocol Data Channel (RCDataChannel)

*RCDataSources* and *RCDataSinks* shall support the *RTSPDataChannel* as defined in Subsection [26.4.2](#).

*RCDataSources* shall transport *TmNSDataMessages* to the *RCDataSink*'s IP address and the destination port specified in the transport header.

#### 26.4.3.2 RC Delivery Protocol Control Channel (RCControlChannel)

*RCDataSources* and *RCDataSinks* shall exchange control commands and parameters using the *RTSPControlChannel*, as defined in Subsection [26.4.1](#). This section specifies additional constraints on using the *RTSPControlChannel* as the *RCControlChannel*.

The RTSP transport header shall specify TCP, which shall be used for the transport of *TmNSDataMessages* on the *RCDataChannel*.

A *DataRequest* from an *RCDataSink* shall use at least one of the following three request types as specified in Subsection [26.4.1.5](#):

- MessageDefinitionID request;
- PackageDefinitionID request;
- MeasurementID request.

#### 26.4.4 Request-Defined Data Channel

This section is a placeholder for future growth.

### 26.5 *TmNSDataMessage* Transfer Rules

*DataSources* and *DataSinks* shall comply with the standard *TmNSDataMessage* structure and mechanisms, as specified in [Chapter 24](#). *DataSources* shall adhere to the following *TmNSDataMessage* transfer rules.

1. Multiple sequences of *TmNSDataMessages* that contain different *MessageDefinitionIDs* may be sent to the same multicast or unicast destination address.
2. Multiple *DataSources* shall not send *TmNSDataMessages* with the same *MessageDefinitionID* to the same destination address unless the multiple *DataSources* synchronize the incrementing of the **MessageSequenceNumber** field in accordance with the sequence number convention specified in Subsection [26.5.1](#).
3. Replicated *TmNSDataMessages* may be sent to multiple destination addresses provided rule 2 above is not violated.

 <p><b>NOTE</b></p>	<p>When adding <i>Packages</i> to the acquisition <i>TmNSDataMessage</i> payload, a <i>DataSource</i> should use a mechanism taking the minimum of “maximum message size” and “maximum elapsed time” variables to determine when to send a complete <i>TmNSDataMessage</i> of sampled data.</p>
--	---

### 26.5.1 Sequence Numbering Convention

Each *TmNSDataMessageHeader* contains a **MessageSequenceNumber** field whose value increments by one for each *TmNSDataMessage* instance in a sequence of *TmNSDataMessages*. The **MessageSequenceNumber** value shall wrap to zero after  $2^{32} - 1$ . The wrapping of the **MessageSequenceNumber** value to zero shall not indicate a loss.

For *DataSources* generating *TmNSDataMessages*, **MessageSequenceNumber** values are assigned on a per-*MessageDefinitionID* basis.

The **MessageSequenceNumber** value shall not repeat consecutively or be generated out of order for a particular sequence of *TmNSDataMessages*, including when two or more *DataSources* generate *TmNSDataMessages* with the same *MessageDefinitionID*.

The **MessageSequenceNumber** field for a *TmNSDataMessage* sequence shall be set to zero upon one of the following:

- The power-up or reset of the *NetworkNode* generating the corresponding *TmNSDataMessage* sequence;
- The configuration, reconfiguration, or reset of the *TmNSApp* generating the corresponding *TmNSDataMessage* sequence;
- The instantiation of a Request-Defined *DataChannel* generating the corresponding *TmNSDataMessage* sequence.

### 26.5.2 Timestamp Convention

The **MessageTimestamp** value of a given *TmNSDataMessage* shall be no earlier than all of the acquisition times of *MeasurementData* samples in the previous *TmNSDataMessage* instance in the sequence of *TmNSDataMessages*. See Subsection [26.5.1](#) for the description of a sequence of *TmNSDataMessages*.

### 26.5.3 TmNSDataMessage Fragmentation

*TmNSDataMessages* support being broken up into multiple fragments. The **MessageFragmentationFlags** of the *TmNSDataMessageHeader* identify how to reconstruct a full *TmNSDataMessage*. All fragments of a *TmNSDataMessage* shall include the same value for the **MessageTimestamp** and **MessageFlags** fields in their *TmNSDataMessageHeader* with the following exception for the **MessageFragmentationFlags** bits:

- The first fragment shall set the **MessageFragmentationFlags** bits to “2’b01” (*TmNSDataMessage* with the first fragment);
- Each middle fragment shall set the **MessageFragmentationFlags** bits to “2’b10” (*TmNSDataMessage* with a middle fragment);
- The last fragment shall set the **MessageFragmentationFlags** bits to “2’b11” (*TmNSDataMessage* with the last fragment).

Each fragment’s **MessageSequenceNumber** field value shall follow the sequence numbering convention as described in Subsection [26.5.1](#).

26.5.4 Generating *TmNSDataMessages* from Other *TmNSDataMessages* Convention  
*DataSources* that combine data from multiple *TmNSDataMessages* into a new *TmNSDataMessage* shall bitwise-OR the following *DataSource*-specific **MessageFlags** from the original *TmNSDataMessages* to form the resultant *DataSource*-specific **MessageFlags**:

**DataSourceHealthFlag**

**DataSourceTimeLockFlag**

**DataSourceAcquiredDataFlag**

Any **ApplicationDefinedFields** in the transferred *TmNSDataMessages* shall indicate conditions on the *DataSource* delivering the *TmNSDataMessages*, not the original *DataSource* (the **ApplicationDefinedFields** from the original *TmNSDataMessages* are discarded).

## APPENDIX 26-A

### Citations

- Internet Engineering Task Force. “Hypertext Transfer Protocol – HTTP/1.1.” RFC 2068. Obsoleted by RFC 2616. January 1997. Retrieved 17 May 2021. Available at <https://datatracker.ietf.org/doc/rfc2068/>.
- . “Real Time Streaming Protocol (RTSP).” RFC 2326. Obsoleted by RFC 7826. April 1998. Retrieved 17 May 2021. Available at <https://datatracker.ietf.org/doc/rfc2326/>.

**\*\*\*\* END OF CHAPTER 26 \*\*\*\***

## CHAPTER 27

### RF Network Access Layer

<b>Acronyms</b> .....	<b>27-iii</b>
<b>Chapter 27. RF Network Access Layer</b> .....	<b>27-1</b>
<b>27.1 Introduction</b> .....	<b>27-1</b>
<b>27.2 Radio Access Network Concepts and Definitions</b> .....	<b>27-1</b>
27.2.1 Data Link Layer Framing.....	27-1
27.2.2 RF Media Access Control Layer.....	27-2
27.2.3 Epoch Structure.....	27-2
27.2.4 Transmission Opportunities .....	27-3
27.2.5 Timing.....	27-3
27.2.6 Radio Link State Parameters.....	27-3
27.2.7 Frame Check Sequence.....	27-3
<b>27.3 Physical Layer</b> .....	<b>27-3</b>
27.3.1 Data Rates and Spectrum .....	27-3
27.3.2 Regulatory Specifications, Spectral Mask .....	27-4
27.3.3 Carrier and Clock Frequency Error, Phase Noise, Spurs, Receiver Sensitivity 27-6	
<b>27.4 RF Burst Format</b> .....	<b>27-7</b>
27.4.1 Physical Layer Modulation .....	27-7
27.4.2 Preamble .....	27-8
27.4.3 Attached Synchronization Marker .....	27-8
27.4.4 Pseudo-Randomization .....	27-8
27.4.5 Low-Density Parity-Check .....	27-10
<b>27.5 RF Media Access Control Frame Structure</b> .....	<b>27-10</b>
27.5.1 RF MAC Header .....	27-11
27.5.2 CCMP Header.....	27-12
27.5.3 RF MAC Payload.....	27-13
27.5.4 Message Integrity Code .....	27-13
27.5.5 Frame Check Sequence Field.....	27-13
<b>27.6 Power Transients</b> .....	<b>27-13</b>
<b>Appendix 27-A. Air Data Rate Model</b> .....	<b>A-1</b>
<b>Appendix 27-B. Citations</b> .....	<b>B-1</b>

### List of Figures

Figure 27-1. OSI Model as related to the TmNS RF Network.....	27-1
Figure 27-2. Data Link Layer Framing Overview.....	27-2
Figure 27-3. Example Waveform PSD with Spectral Mask Overlay .....	27-5

Figure 27-4. Single Sideband Phase Noise..... 27-6  
Figure 27-5. RF Burst Format ..... 27-7  
Figure 27-6. SOQPSK-TG Burst Preamble..... 27-8  
Figure 27-7. Pseudo-Randomizer ..... 27-9  
Figure 27-8. Pseudo-Randomization Block Diagram..... 27-9  
Figure 27-9. RF MAC Frame Structure..... 27-10  
Figure 27-10. RF MAC Header Structure ..... 27-11  
Figure 27-11. Example TxOp Timing of a Single TxOp Allocation..... 27-14  
Figure 27-12. Example TxOp Timing of Two Back-to-Back TxOp Allocations..... 27-14

**List of Tables**

Table 27-1. Transceiver Phase Noise Mask..... 27-6  
Table 27-2. Maximum Doppler Shift..... 27-7



## Acronyms

$\mu$ s	microsecond
ACK	acknowledgement
AES	Advanced Encryption Standard
ASM	attached synchronization marker
CBER	codeblock error rate
CCMP	Counter with Cipher Block Chaining Message Authentication Code mode Protocol
dBc	decibels relative to the carrier
FCS	frame check sequence
FPSH	fragmentation/packing sub-header
GHz	gigahertz
HAIPe	High Assurance Internet Protocol Encryptor
IP	Internet Protocol
kHz	kilohertz
LDPC	low-density parity-check
MAC	media access control
MHz	megahertz
MIC	Message Integrity Code
MSDU	MAC service data unit
OSI	Open Systems Interconnection
PLR	packet loss rate
ppm	parts per million
RC	Reliability Critical
RF	radio frequency
RFC	Request for Comment
SOQPSK	shaped offset quadrature phase shift keying
TA	test article
TCP	Transmission Control Protocol
TmNS	Telemetry Network Standard
TxOp	transmission opportunity

This page intentionally left blank.

## CHAPTER 27

### RF Network Access Layer

#### 27.1 Introduction

This chapter defines the mechanisms and processes for managing the physical layer of radio frequency (RF) links within the RF network. The network implements an Open Systems Interconnection (OSI) model approach (Figure 27-1) to data transmission, where data moves through the OSI stack from the application layer to the physical layer, from physical layer to physical layer through some transmission medium, then back up the stack to another application on the receiving side. Because the system is network-based, transmissions occur in bursts that are scheduled as data arrives.

OSI Model					
Layer	Data Unit	Function	Examples		
Host Layers	7. Application	Data	High Level APIs, including resource sharing, remote file access, directory services and virtual terminals	HTTP, FTP, SNMP, SSH, TELNET	
	6. Presentation		Translation of data between a networking service and an application, including character encoding, data compression and encryption/decryption	HTML, CSS, GIF	
	5. Session		Managing communications sessions, i.e. continuous exchange of information in the form of multiple back-and-forth transmissions between two nodes	RPC, PAP, SSL, SQL	
	4. Transport	Segments/Datagram	Managing communications sessions, i.e. continuous exchange of information in the form of multiple back-and-forth transmissions between two nodes	TCP, UDP, NETBEUI	
Media Layers	3. Network	Packet	Structuring and managing a multi-node network, including addressing, routing and traffic control	IPv4 IPv6, IPsec, Apple Talk, ICMP	
	2. Data Link	Frame	Reliable transmission of data frames between two nodes connected by a physical layer	PPP, IEE 802.2 L2TP, MAC, LLDP	IRIG 106 Chapter 28
	1. Physical	Bit	Transmission and reception of raw bit streams over a physical medium	Ethernet physical layer, DSL USB, ISDN, DOCSIS	Covered by this chapter

Figure 27-1. OSI Model as related to the TmNS RF Network

This chapter describes the low-level waveform content (e.g., Frequency, Modulation, Framing, etc.). Chapter 28 focuses on access to and management of the RF portion of a Telemetry Network Standard (TmNS)-based network. Chapter 21 Appendix 21-B describes the bit numbering, bit ordering, and byte ordering conventions used in this chapter.

#### 27.2 Radio Access Network Concepts and Definitions

##### 27.2.1 Data Link Layer Framing

The RF network provides a standards-based Internet Protocol (IP) network (Internet Engineering Task Force Request for Comment (RFC) 791<sup>1</sup> and RFC 2474<sup>2</sup>). Layers supporting this IP layer are unique to the RF network. Figure 27-2 shows an overview of the protocol layers associated with sending an IP packet over the data link layer and RF physical interface. The IP

<sup>1</sup> Internet Engineering Task Force. "Internet Protocol." RFC 791. Updated by RFC 2474, RFC 6864, and RFC 1349. September 1981. Retrieved 17 May 2021. Available at <https://datatracker.ietf.org/doc/rfc791/>.

<sup>2</sup> Internet Engineering Task Force. "Definition of the Differentiated Services Field (DS Field) in the IPv4 and IPv6 Headers." RFC 2474. Updated by RFC 3260, RFC 3168, and RFC 8436. December 1998. Retrieved 17 May 2021. Available at <https://datatracker.ietf.org/doc/rfc2474/>.

packets are referred to as RF media access control (MAC) service data units (MSDUs) and are comprised of complete IP packets containing user data. The MSDUs are placed into payload blocks with aggregation and fragmentation performed to meet the maximum transmission unit of the RF channel. The length-limited payload blocks are separated into RF MAC frames and link layer header information is added. Forward error correction is added to the RF MAC frames to create low-density parity-check (LDPC) blocks suitable for transmission over the RF link. Details of the higher levels of this protocol are covered in [Chapter 28](#).

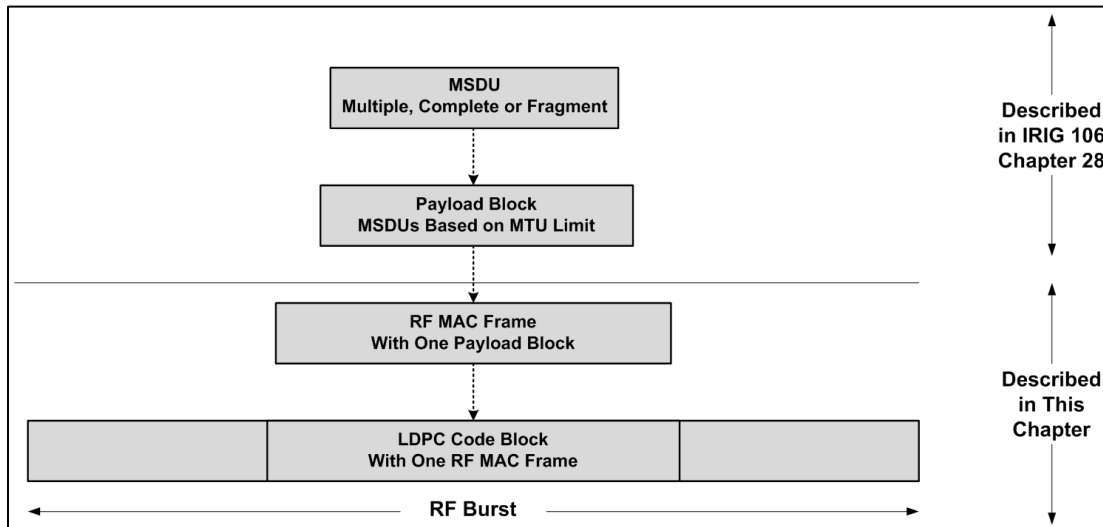

Figure 27-2. Data Link Layer Framing Overview

On the receiving end of the RF link, the physical layer recovers the transmitted bitstream by decoding and concatenating codeblocks arriving in the transmission opportunity's (TxOp's) time slots. Each decoded codeblock contains one MAC frame. These RF MAC frames contain complete IP packets or an IP packet composed of multiple MSDU fragments. [Chapter 28](#) describes MSDUs in more detail.

When a link layer frame is constructed for transmission in the process described here, the completed link layer frame sent shall not exceed the remaining portion of the current TxOp.

### 27.2.2 RF Media Access Control Layer

The RF MAC layer is responsible for providing access to the physical media (i.e., the wireless RF network). On the transmission side, it is responsible for framing IP packets for physical transmission (adding in the layer-2 hardware addresses for the source/destination pair of the link). On the receive side it is responsible for validating the checksum sent with each packet (known as the frame check sequence [FCS], Subsection [27.2.7](#)) and de-framing the received packet.

### 27.2.3 Epoch Structure

An epoch-based scheme is used to separate transmission signals over a time-shared medium. The RF network implements an epoch-based transmission scheduling scheme to provide an efficient utilization over a shared bandwidth. Link management messages support dynamic adjustment of the epoch schedule being utilized by components comprising an RF network.

#### 27.2.4 Transmission Opportunities

A TxOp is an allocated window in time during which a radio can transmit over its associated RF interface. The TxOp contains a frequency, a start time and a stop time that is relative to the epoch, and a timeout field that indicates the number of consecutive epochs that the TxOp is valid for. The frequency associated with the TxOp is the carrier frequency at which the transceiver shall transmit for the duration of the TxOp. At the stop time, the transceiver remains tuned to the TxOp's carrier frequency in order to receive incoming transmissions at the frequency. The epoch is settable to a number of discrete times during radio initialization.

#### 27.2.5 Timing

The RF link management and all radios under its control shall have their clocks synchronized. The timing of access to the RF media shall be synchronized to and match the timing with the management layer described in [Chapter 22](#). The format of the time in RF network messages is defined in [Chapter 24](#).

#### 27.2.6 Radio Link State Parameters

Operating parameters of a radio shall be stored to maintain communications with RF link management after a power interruption or software-initiated reset. Parameters to be stored include, as a minimum, the operating frequency of the radio, the TxOp allocations that contain a non-expiring timeout setting, and the heartbeat value.

#### 27.2.7 Frame Check Sequence

The FCS contained at the end of an RF MAC frame shall serve as a link layer error-checking mechanism. The FCS generation and verification is described in Subsection [27.5.5](#).

### **27.3 Physical Layer**

The physical layer focuses on describing the operating bands, waveform modulation/demodulation characteristics, carrier stability and synchronization/acquisition characteristics, and coding/decoding techniques. The TmNS system provides the capability of the range to support multiple concurrent test missions on one or more integrated Network Enhanced Telemetry frequency channels. The frequency channels available for use in a TmNS-based RF network are as defined in Subsection [27.3.1.2](#). Allowable adjacent channel interference for transmissions is defined in Subsection [27.3.2](#). Each transmission is performed as discrete bursts within start and stop times that are provisioned within a configured epoch time by an external configuration file and/or RF link management as defined in [Chapter 28](#).

Transmissions between radios on test articles (TAs) and those contained in the ground network shall use the same carrier frequency in both directions. Single carrier frequency usage is supported by employing a time-domain duplex channel access method. In this method radios use re-occurring epoch-based transmissions defined by start and stop times that are provisioned by RF link management.

#### 27.3.1 Data Rates and Spectrum

##### 27.3.1.1 Radio Air Data Rates

The data rates and link performance in terms of packet loss rate (PLR) stated below are provided based on 1000-byte-long Ethernet packet (see [Appendix 27-A](#) for additional details).

Assuming the codeblock error events to be independent, the relation between codeblock error rate (CBER) and PLR is then given by  $CBER = 1 - \sqrt{1 - PLR}$ . For example, for a PLR of  $1 \times 10^{-4}$ , the corresponding CBER is  $5 \times 10^{-5}$ .

Subsection [27.3.2.2.2](#) details the air data rates that radios shall comply with in order to ensure interoperability.

Rate requirements can be viewed from various aspects. When viewed from an OSI 7-layer protocol stack perspective, the RF communications link is at layer-2. This implies that all overhead affiliated with layer-3 through layer-7, including any IP and High Assurance Internet Protocol Encryptor (HAIPe) headers, are regarded as user data. The effective PLR is referenced to a mean packet size and is described in [Appendix 27-A](#).

 <p><b>NOTE</b></p>	<p>The air data rates are derived from a model that assumes a certain IP packet distribution such that the airborne network and throughput goals are met. Details concerning how to get from IP data payload rate to the air data rate are in <a href="#">Appendix 27-A</a>.</p>
--	--

### 27.3.1.2 Band of Operation

It is recommended that RF telemetry networks of the type described in this standard utilize the following frequencies: 4900.0 MHz and 4922.0 MHz. This facilitates interoperability and simultaneous operation of serial streaming telemetry and networked telemetry within airborne and ground systems. These channels have been coordinated through the Frequency Management Group of the Range Commanders Council. Range users should consult with their respective spectrum managers regarding the use of these channels at their ranges prior to designing, building, or fielding telemetry networks.

### 27.3.2 Regulatory Specifications, Spectral Mask

#### 27.3.2.1 SOQPSK-TG Single-Carrier Waveform – Spectral Mask

The RF emission spectral mask defined in [Chapter 2](#) shall be adopted for the single-carrier waveform for shaped offset quadrature phase shift keying (SOQPSK)-TG. Peak waveform power density for the SOQPSK-TG waveform is estimated to be  $-25$  decibels relative to the carrier (dBc)/30 kHz using the equation in [Chapter 2](#) Appendix 2-A with  $R_b = 20$  Mbps,  $K = -61$ , and  $m = 4$ .

$$M(f) = -61 + 90 \log R - 100 \log |f - f_c|; |f - f_c| \geq 5$$

 <p><b>NOTE</b></p>	<p><a href="#">Figure 27-3</a> shows a simulated SOQPSK-TG waveform and overlay with single-carrier spectral mask. The power spectra was calculated for 20-Mbps channel bit rate and compared with the continuous stream power spectra for a resolution bandwidth of 30 kHz. It was measured during the steady power condition during a burst transmission.</p>
--	---

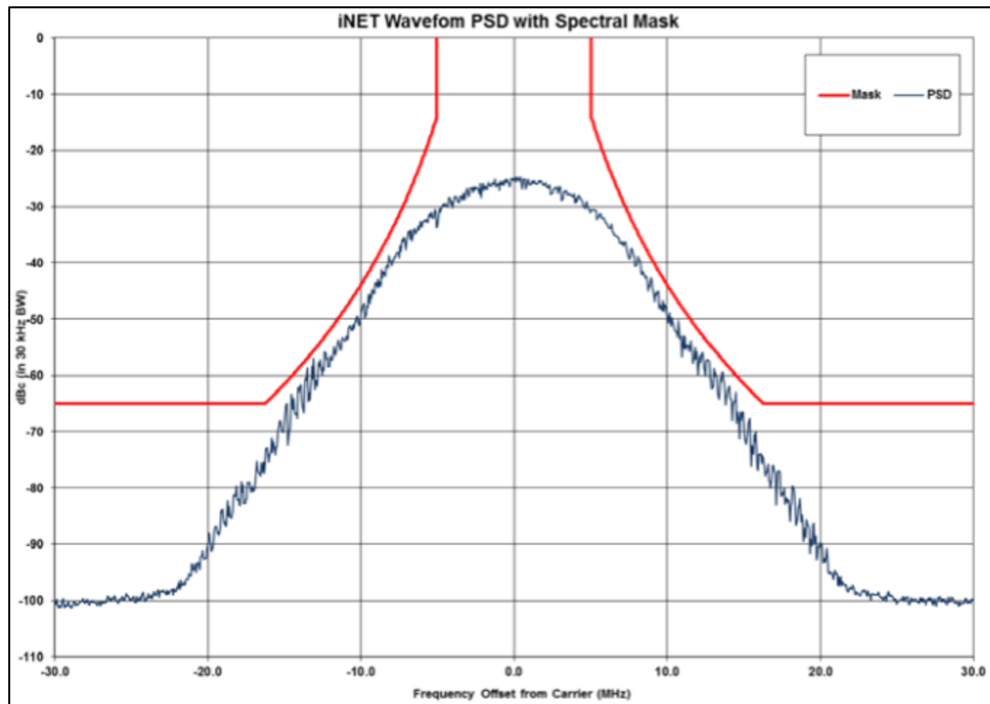

Figure 27-3. Example Waveform PSD with Spectral Mask Overlay

### 27.3.2.2 SOQPSK-TG Single-Carrier Waveform - Bandwidth

#### 27.3.2.2.1 Occupied Bandwidth

The SOQPSK-TG single-carrier waveform characteristics are defined in [Chapter 2](#). The waveform operating bands are defined in Subsection [27.3.1.2](#). The occupied bandwidth is defined to be the 99% power bandwidth, which for SOQPSK-TG is calculated to be 15.6 MHz for an air channel rate of 20 Mbps based on Table A-2, Appendix 2-A.

#### 27.3.2.2.2 Air Information Bit Rate

With the  $R_b$  fixed at 20 Mbps, the air information bit rate is 13.3 Mbps due to the 2/3 LDPC encoding.

#### 27.3.2.2.3 Guard-Bands and Band Edge Spurious Level

Spurious emissions are absolute limited to  $-25$  dBm. Guard-bands are identified via Adjacent Channel Interference criteria as defined in IRIG-106. See [Chapter 2](#) Appendix 2-A.

### 27.3.2.3 Multiple-Carrier Waveform - Spectral Mask

This section is a placeholder for future growth.

### 27.3.2.4 Multiple-Carrier Waveform - Bandwidth

This section is a placeholder for future growth.

27.3.3 Carrier and Clock Frequency Error, Phase Noise, Spurs, Receiver Sensitivity

27.3.3.1 SOQPSK-TG Single-Carrier Transmission

27.3.3.1.1 *Carrier Frequency Error*

The radio carrier frequency error shall be bounded by  $\pm 5$  parts per million (ppm). This corresponds to a frequency shift of  $\pm 25$  kHz at a transmission frequency of 5 gigahertz (GHz).

27.3.3.1.2 *Transceiver Phase Noise*

Random transceiver phase noise at the transceiver RF output port,  $L(|\Delta f|)$  in dBc/Hz, shall not exceed the mask limits in [Table 27-1](#). The parameter  $|\Delta f|$  is offset from the carrier frequency and  $R_b$  is the radio air channel bit rate in bits per second. The total power in discrete (deterministic) spurious noise components shall not exceed  $-30$  dBc in the same frequency offset range. Compliance with the mask shall be checked while the transceiver is producing an unmodulated continuous carrier signal at both the minimum and maximum power levels available for modulated burst transmission.

<b>Table 27-1. Transceiver Phase Noise Mask</b>	
<b>dBc/Hz</b>	<b>Frequency Offset</b>
-30 dBc/Hz	10 Hz
-60 dBc/Hz	100 Hz
-70 dBc/Hz	1 kHz
-80 dBc/Hz	10 kHz
-90 dBc/Hz	100 kHz
-100 dBc/Hz	1 MHz

The upper limit of the single sideband phase noise described by [Table 27-1](#) is depicted in [Figure 27-4](#).

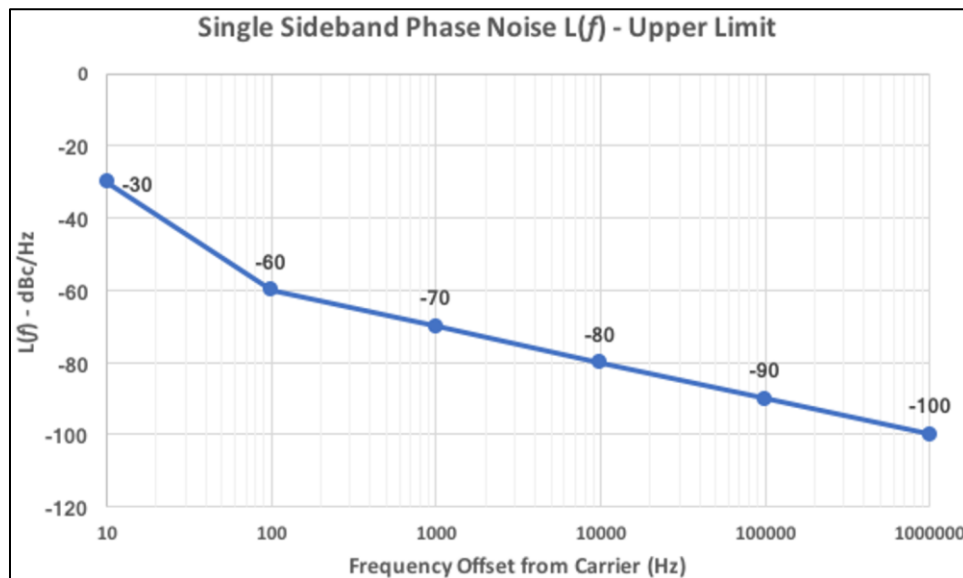

Figure 27-4. Single Sideband Phase Noise



27.3.3.1.3 *Frequency Error Attributed to Doppler*

The radio transmission frequency error seen at the receiver due to Doppler effects shall be bounded by  $\pm 2.5$  ppm. This corresponds to a frequency error spread of  $\pm 12.5$  kHz at a transmission frequency of 5 GHz. This frequency shift due to Doppler effects is budgeted for the combined total of relative motion between two transceivers, either between a stationary transceiver and a moving transceiver or between two moving transceivers. The maximum Doppler shift for a set of example carrier frequencies is provided in [Table 27-2](#) below.

<b>Table 27-2. Maximum Doppler Shift</b>	
<b>Carrier Frequency</b>	<b>Maximum Doppler Shift (<math>\pm 2.5</math> ppm)</b>
5 GHz	12.5 kHz
2.4 GHz	6 kHz
1.5 GHz	3.75 kHz

27.3.3.1.4 *Symbol Clock Frequency Error*

The radio transmission symbol clock frequency error shall be bounded by  $\pm 5$  ppm.

27.3.3.1.5 *Transmission Time Accuracy*

The radio transmission shall begin within  $\pm 1$   $\mu$ s of the intended transmission time.

27.3.3.2 Multiple-Carrier Transmission

This section is a placeholder for future growth.

 <p><b>NOTE</b></p>	Multiple-carrier waveform spectrum is subject to ongoing evaluation.
--	--

27.4 **RF Burst Format**

The RF burst format is displayed in [Figure 27-5](#).



Figure 27-5. RF Burst Format

The RF burst format contains a preamble, an attached synchronization marker (ASM), a codeblock frame, and 2 bits of trailing zeros to return the encoder to a flushed state. A codeblock frame may contain an integer multiple of LDPC codeblocks, from a minimum of 1 up to a maximum of 16. The number of LDPC codeblocks in a codeblock frame are specified during configuration.

27.4.1 Physical Layer Modulation

A single-carrier SOQPSK modulation scheme shall be used. The waveform shall be implemented as defined in [Chapter 2](#) Subsection 2.4.3.2.

### 27.4.2 Preamble

For the SOQPSK-TG waveform adopted for the single-carrier physical layer modulation format, the burst preamble is formed as described in [Figure 27-6](#). Starting from a flushed trellis (00 state), alternate the in-phase (I) and quadrature (Q) bits as follows.

$$\left. \begin{array}{l} \text{In-phase: } b_{2k} = 1, 0, 1, 0, 1, 0, 1, 0 \\ \text{Quadrature: } b_{2k+1} = 1, 0, 1, 1, 0, 1, 0, 0 \end{array} \right\} \text{ for } k = 0, \dots, 7$$

repeated  $128/16 = 8$  times

Figure 27-6. SOQPSK-TG Burst Preamble

This leads to a period-16 ternary symbol sequence  $\{\alpha_k\}$  with the following structure.

$$\underbrace{(+1, +1, +1, +1, +1, +1, +1, 0)}_{7 \text{ +1s}}, \underbrace{(-1, -1, -1, -1, -1, -1, -1, 0, \dots)}_{7 \text{ -1s}}$$

For a 128-bit preamble, there shall be 8 full cycles of the period-16 preamble present in the transmitted SOQPSK-TG waveform.

### 27.4.3 Attached Synchronization Marker

For codeblock frame synchronization, a 64-bit ASM (64'h0347 76C7 2728 95B0) shall be used for each codeblock frame. This burst synchronizer can also be used for resolving phase ambiguity at the receiver.

### 27.4.4 Pseudo-Randomization

The pseudo-random sequence shall be generated using the following polynomial:  $h(x) = x^8 + x^7 + x^5 + x^3 + 1$ . It has a maximal length of 255 bits with the first 40 bits of the pseudo-random sequence from the generator as 40'b1111 1111 0100 1000 0000 1110 1100 0000 1001 1010. The sequence begins at the first bit of the first codeblock in a codeblock frame, and the sequence repeats after 255 bits, continuing repeatedly until the end of the last codeblock in a codeblock frame. The leftmost bit of the pseudo-random sequence is the first bit to be exclusive-ORed with the first bit of the codeblock. The pseudo-randomizer shown in [Figure 27-7](#) is described in more detail in [Chapter 2](#), Appendix 2-D.

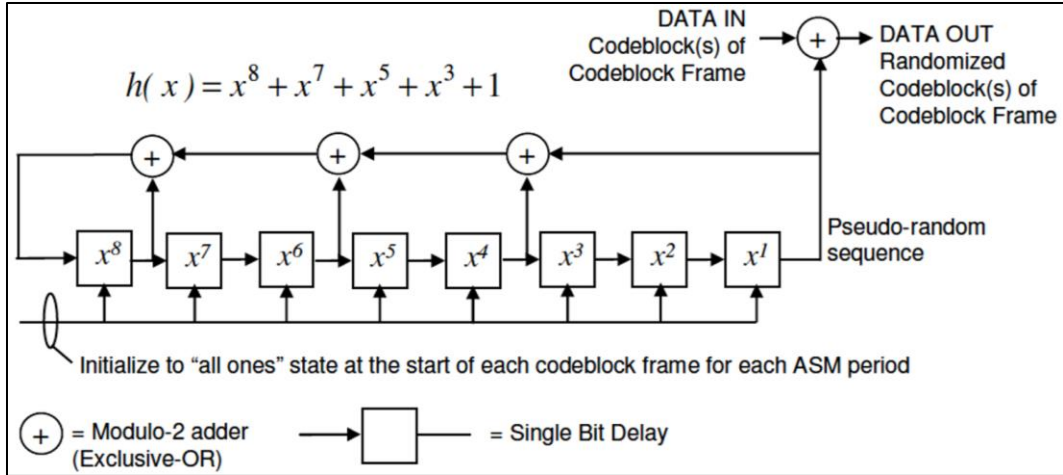

Figure 27-7. Pseudo-Randomizer

At the transmitter, a set of codeblocks in a codeblock frame shall be randomized by exclusive-ORing the first bit of the first codeblock with the first bit of the pseudo-random sequence, followed by the second bit of the first codeblock with the second bit of the pseudo-random sequence, and so on. The pseudo-randomizer resets to the initial state of “all ones” at the start of each codeblock frame for each ASM period.

At the receiver, each original codeblock of a codeblock frame shall be reconstructed using the same pseudo-random sequence. After locating the ASM, the pseudo-random sequence is exclusive-ORed with the received data bits immediately following the ASM. The pseudo-randomizer resets to the initial state of “all ones” at the start of each received codeblock frame for each ASM period.

The ASM, depicted in [Figure 27-8](#), is not randomized. Randomization ensures that coded symbols are spectrally near-white, thus allowing each ASM to provide synchronization for a set of randomized codeblock(s) in a codeblock frame.

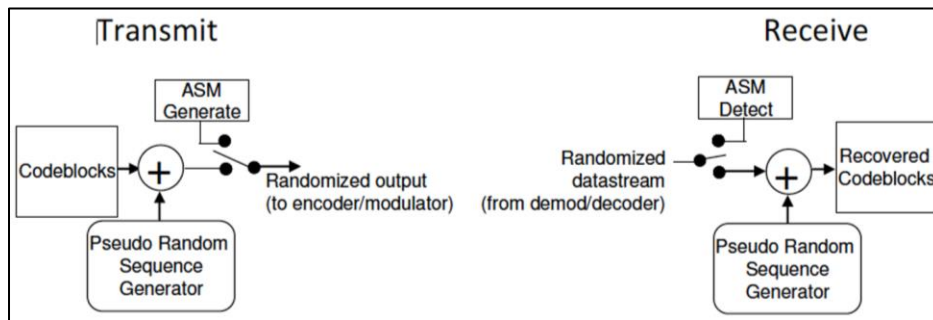

Figure 27-8. Pseudo-Randomization Block Diagram

At the transmitter side, the ASM is prepended to each set of randomized codeblocks as the synchronization header. At the receiver side, the ASM is detected and located in the received data stream. Then the pseudo-random sequence is exclusive-ORed with the data bits immediately following the ASM location.

#### 27.4.5 Low-Density Parity-Check

Each LDPC codeblock shall contain one 512-byte RF MAC frame or, if the RF MAC frame is not 512 bytes, padding bytes with values of zero shall be added after the FCS to fill a 512-byte codeblock before encoding.

The Forward Error Correction code shall be an LDPC code as specified in CCSDS 131.1-O-2.<sup>3</sup>

A reference implementation of the LDPC is available from [Chapter 2](#) Appendix 2-D using the values  $r=2/3$  and  $k=4096$ .

### 27.5 RF Media Access Control Frame Structure

The MAC frame structure determines what RF transmissions are received by a receiving radio. The RF MAC filters received traffic, accepting only those transmissions that the radio is interested in receiving.

The network message headers for RF MAC control frames contain the destination, source, and a sequence number. The destination address is either an RF MAC address of the destination radio or an RF multicast address that specifies the multicast group of one or more receiving radios. The source address is always the RF MAC address of the transmitting radio. A sequence number is included to allow for duplicate rejection and identification of a specific link layer command.

Each RF MAC frame shall contain an RF MAC header, a CCMP header, an RF MAC payload, a Message Integrity Code (MIC) field, and a 32-bit FCS. The RF MAC frame format is depicted in [Figure 27-9](#).



Figure 27-9. RF MAC Frame Structure

The RF MAC frame processing shall proceed with an equivalent of the following steps.

1. Codeblock is received, and the LDPC is decoded.
2. For successfully decoded LDPCs, the link layer processing checks the FCS.
3. The RF MAC frames with correct FCS fields are further inspected for the Destination Address field in the RF MAC header.
4. Further processing is carried out for RF MAC frames that contain a Destination Address for which the receiving radio has been assigned to listen.
  - a. If the Protected Frame bit indicates decryption is needed, the link layer processing then decrypts the frame and checks the MIC.
  - b. Unencrypted and successfully decrypted RF MAC payloads are processed as network data as described in [Chapter 28](#).

<sup>3</sup> Consultative Committee for Space Data Systems. *Low Density Parity Check Codes for Use in Near-Earth and Deep Space Applications*. Standard CCSDS 131.1-O-2-S. September 2007. Rescinded. Retrieved 17 May 2021. Available at <https://public.ccsds.org/Pubs/131x1o2e2s.pdf>.

Rejection at any of the steps described above does not require further processing, and the RF MAC frame shall be discarded; however, statistics for discarded RF MAC frames shall be maintained as described in [Chapter 25](#).

27.5.1 RF MAC Header

The RF MAC header is 64 bits long and shall consist of the fields as shown in [Figure 27-10](#).

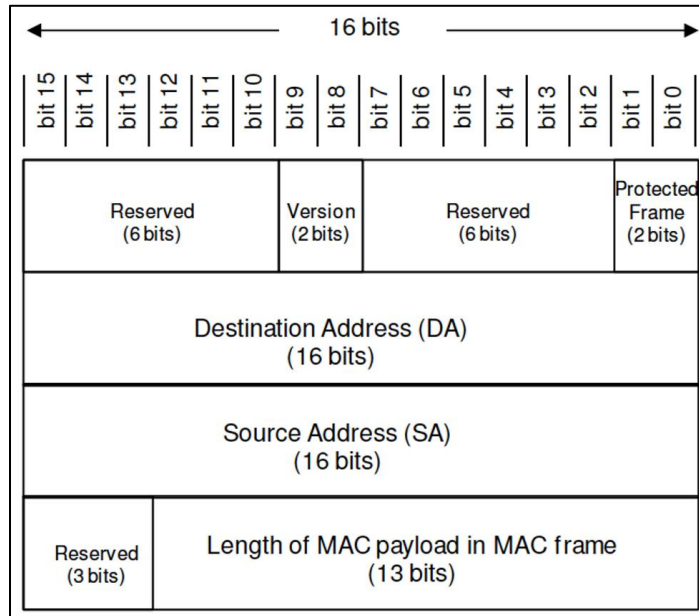



Figure 27-10. RF MAC Header Structure

**NOTE**  In the future, it may be desirable to have a MAC frame that spans 1-16 codeblocks. To provide for this future capability, the Length field in the MAC header is large enough to accommodate values up to 8192, i.e., [0 .. 8124] bytes (maximum of 16 codeblocks).

27.5.1.1 Frame Control

The Frame Control field of the RF MAC header is 16 bits in length and shall contain the fields defined in Subsection [27.5.1.1.1](#) through Subsection [27.5.1.1.4](#).

27.5.1.1.1 *Reserved Field 1 (6 bits)*

This field is reserved for future use. All bits shall be set to zero (6'b000000) on transmission; ignored on reception.

27.5.1.1.2 *Version Field (2 bits)*

This field specifies the version of the RF MAC frame. This chapter defines the RF MAC Frame Version 1 (2'b00).

27.5.1.1.3 *Reserved Field 2 (6 bits)*

This field is reserved for future use. All bits shall be set to zero (6'b000000) on transmission; ignored on reception.

#### 27.5.1.1.4 Protected Frame Field (2 bits)

This field indicates whether or not the RF MAC payload is encrypted. Transmitters shall set this field according to its configuration provided through a Metadata Description Language file. Receivers shall use this field to determine how to process the RF MAC payload.

This chapter defines the following versions:

- 2'b00 – Unprotected Frame
- 2'b01 – Advanced Encryption Standard (AES) - Counter with Cipher Block Chaining Message Authentication Code mode Protocol (CCMP)
- 2'b10 – Reserved for future use
- 2'b11 – Reserved for future use

#### 27.5.1.2 Destination Address

This 16-bit field contains the RF MAC address of the next hop destination radio or multicast RF MAC address. Additional details of RF MAC addressing are found in [Chapter 28](#).

#### 27.5.1.3 Source Address

This 16-bit field contains the RF MAC address of the transmitting radio. Additional details of RF MAC addressing are found in [Chapter 28](#).

#### 27.5.1.4 Reserved

This 3-bit field is reserved for future use. On transmission, the transmitting radio shall set this field to 3'b000. On reception, the receiving radio shall ignore these bits.

#### 27.5.1.5 Length

This 13-bit field contains the length in bytes of the RF MAC payload in the RF MAC frame. This value does not include the length of the RF MAC header or the associated FCS. The valid range for this field is [0 .. 500].

The Length field in the RF MAC header is used to separate valid bytes from padding bytes in the RF MAC frame. If there are valid bytes in the RF MAC payload, the first fragmentation/packing sub-header (FPSH) is checked for the priority and length of the subsequent MSDU\_block. The FPSH and its MSDU\_block are then passed for further processing. While valid bytes remain in the RF MAC payload, the next FPSH is checked and processing continues as above. Any padding bytes are discarded. Processing of bits within the RF MAC payload are described in detail in [Chapter 28](#).

#### 27.5.2 CCMP Header

AN 8-byte CCMP header shall follow immediately after the RF MAC header.

When AES encryption is employed, AES-CCMP encryption shall be used to generate the CCMP header, the encrypted payload, and the MIC. The CCMP header, encryption, and MIC shall follow the recommendations described in NIST SP 800-97.<sup>4</sup>

When AES encryption is not employed, the CCMP header field shall be set to zero (64'h0000 0000 0000 0000) for transmission; ignored on reception.

### 27.5.3 RF MAC Payload

The payload shall be encrypted or unencrypted according to the Protected Frame field of the RF MAC header. The length of the payload shall be in the range of 0-500 bytes.

If encryption is enabled, the AES-CCMP process shall generate the CCMP header.

### 27.5.4 Message Integrity Code

An 8-byte MIC is used. Details of the MIC are described in NIST SP 800-97.

When AES encryption is not employed, the MIC field shall be set to zero (64'h0000) for transmission; ignored on reception.

### 27.5.5 Frame Check Sequence Field

A 32-bit FCS shall be computed over the entire MAC frame, including the MAC header and the entire MAC payload (encrypted or unencrypted), using the IEEE 802.3<sup>5</sup> CRC-32 polynomial below:

$$x^{32} + x^{26} + x^{23} + x^{22} + x^{16} + x^{12} + x^{11} + x^{10} + x^8 + x^7 + x^5 + x^4 + x^2 + x + 1.$$

## 27.6 **Power Transients**

For RF power transients within a TxOp allocation, a radio shall become capable of full-power transmission 25 microseconds ( $\mu$ s) after the radio finishes receiving a transmission intended for it. Once a radio has ceased transmitting, the radio shall disable its transmission and be ready within 15  $\mu$ s to receive a transmission from another radio using default modulation modes and burst rates. A radio shall be capable of receiving consecutive symbol-synchronous burst sequences with no time separation between burst sequences. [Figure 27-11](#) provides an example TxOp timing allocation diagram that highlights the allowable transition times for the transceiver to transition between receiving and transmitting and vice versa. Any ramp-up or ramp-down times associated with a radio shall occur during the TxOp allocation of the radio. When a radio is not executing a TxOp, it shall be listening for RF transmissions from other radios.

---

<sup>4</sup> National Institute of Standards and Technology. "Establishing Wireless Robust Security Networks: A Guide to IEEE 802.11i." SP 800-97. May be superseded by update. Retrieved 17 May 2021. Available at <http://nvlpubs.nist.gov/nistpubs/Legacy/SP/nistspecialpublication800-97.pdf>.

<sup>5</sup> Institute of Electrical and Electronics Engineers. *IEEE standard for Ethernet*. IEEE Std 802.3-2012. New York: Institute of Electrical and Electronics Engineers, 2012.

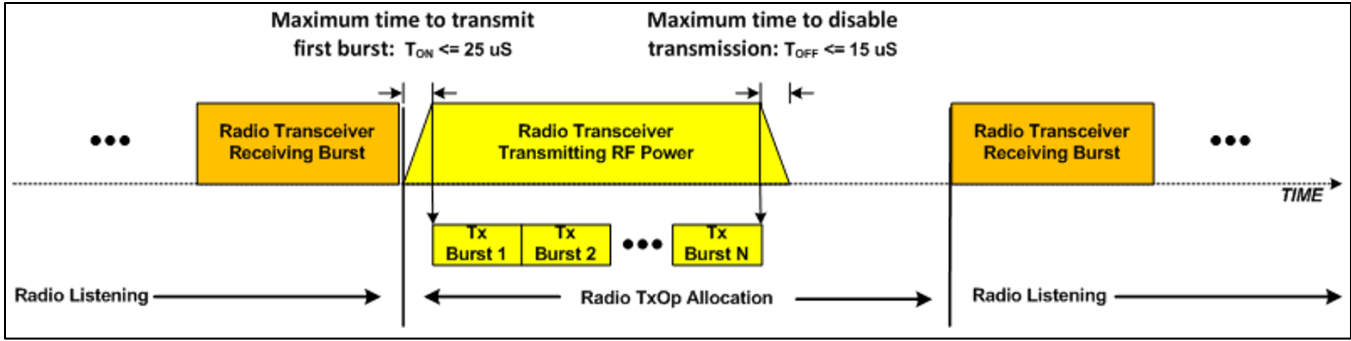

Figure 27-11. Example TxOp Timing of a Single TxOp Allocation

In the example provided in [Figure 27-11](#), the transmitting radio turned off its transmitter prior to the end of its TxOp allocation. If no additional data is available to send, a radio shall stop transmitting RF power.

[Figure 27-12](#) provides an example of another example TxOp timing allocation. This particular example shows two back-to-back TxOp allocations for the same source radio. A radio is not required to shut down its power amplifier if its next allocated TxOp immediately follows the current one.

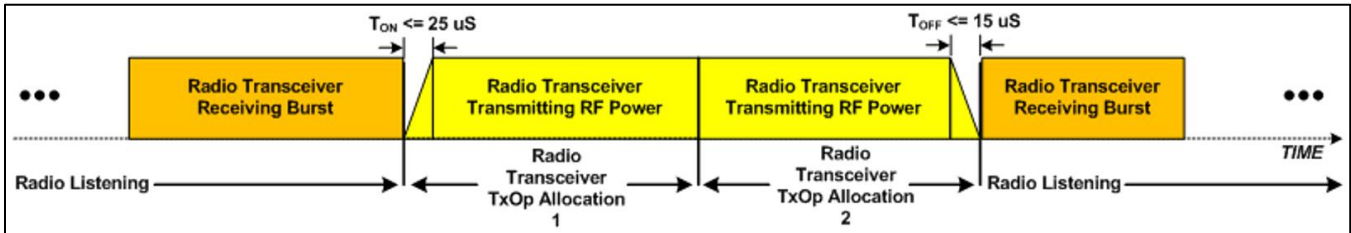

Figure 27-12. Example TxOp Timing of Two Back-to-Back TxOp Allocations



## APPENDIX 27-A

### Air Data Rate Model

Calculations leading to the standardized air data rate for the RF network are based on three spreadsheets. These spreadsheets move from an expected distribution of data use at the application level of the OSI model down through the details of each of the layers leading to the physical layer. Descriptions of the spreadsheets are provided below. While the path concerning the choices made is not directly part of this chapter, the spreadsheets are retained due to their usefulness in explaining the overhead and transformations that occur at each layer of the overall stack.

The first spreadsheet contains parameters that can be used to calculate the link margin. The spreadsheet is contained [here](#).

The second spreadsheet contains equations and calculations pertaining to the RF network. This spreadsheet is contained [here](#). The spreadsheet contains two tabs. The first contains tunable channel parameters that are used to calculate bandwidth estimates. The second contains the required  $E_b/N_0$  calculations. Each worksheet is described below in more detail.

The CH Parameters and BW Estimates worksheet contains tunable knobs that can be modified in order to determine the impact across the rest of the RF network. The most prominent knobs are identified by dark green cells. These include the radio air channel bit rate ( $R_b$ ), the number of TAs in the RF network ( $N_{TAs}$ ), the minimum latency requirement per link, and the max link distance to be accounted for. Light-green cells are also knobs, but their use is expected to be limited. These may be set when initializing the table. This includes the guard band times to allocate across the system as well as an average frame length of network traffic. Gray cells represent constants that shall not be modified. They correspond to parameters such as the LDPC coding rate, LDPC codeblock size, LDPC preamble, ASM sizes, and the goal rate for mission data from the program. The light-pink boxes represent calculated values based on the tuning knobs.

The Req  $E_b/N_0$  Values worksheet contains error rate calculations for SOQPSK modulation schemes. These include bit error rates, frame error rates, packet error rates, and the energy per bit to noise power spectral density ratio ( $E_b/N_0$ ). It correlates the packet error rate to the bit error rate. This is related to the suggested receiver sensitivity in Subsection [27.3.3.1.3](#).

The final spreadsheet describes the data rate calculations for different data flows. This spreadsheet is contained [here](#). This spreadsheet contains three worksheets; each of which describes the achievable data transfer rate for a particular data flow based on the effective bit rate provided over the RF channel. Each worksheet contains the following two tuning knobs.

- **$R_{nt}$  network throughput (Mbps)** – This knob allows the user to specify the total bit rate of the channel for IP data. This data rate represents the maximum data rate available to IP packets, which includes data payload and all other overhead associated with the IP packets.
- **HAIPE Setting** – This knob specifies the block truncation setting configuration of an inline HAIPE device. This knob is used when computing the associated overhead of a particular data flow for cases with block truncation enabled.

When the  $R_{nt}$  network throughput (Mbps) knob is set to the expected IP data rate over the RF channel, the  $R_{md}$  mission data: Application Transfer Rate (Mbps) columns will indicate the theoretical maximum application data rate across the system for the types of data specified. This knob can also be tuned in order to set the  $R_{md}$  mission data: Application Transfer Rate (Mbps) to a particular value. Once the desired application data transfer rate is reached, the knob then indicates the IP network throughput rate that would be required in order to achieve the calculated application data transfer rate.

The three worksheets describe typical data payload and associated protocol overhead bytes for the different types of data. For each data flow in each worksheet, the overhead bytes vary depending on whether block truncation is enabled or not at the encryptor. Calculations are performed for both block truncation enabled and block truncation disabled. For each case, the percent overhead is calculated along with the data transfer rate. The transfer rate is a function of the ratio of data bytes to total bytes (data plus overhead) times the effective IP bit rate available.

A list of assumptions for each worksheet is provided. The data flows in the three worksheets are described below.

### **FTP – Reliability Critical – TCP**

Transmission Control Protocol (TCP)-based data flows, such as file transfer protocol (FTP) transfers and Reliability Critical data retrieval sessions, attempt to maximize payload sizes, which results in lowering the total overhead of the transport. The calculations performed in this worksheet assume the transfers are long transfers that do not experience any connection/disconnection events. It also assumes the typical system default (e.g., un-optimized) TCP parameters. Other assumptions include that for TCP-based data flows, the data packets fit the block truncation size, thus not requiring any additional padding bytes when block truncation is enabled versus when block truncation is disabled. It also assumes that only one acknowledgement (ACK) packet is returned for every 10 FTP data packets sent.

Overhead bytes include FTP overhead, TCP headers, IP headers, and all HAIPE overhead. Because TCP requires ACKs to be returned, these have also been included in the total overhead calculation.

### **Latency Throughput Critical Data**

User Datagram Protocol-based data flows, such as Latency Throughput Critical data delivery of TmNSDataMessages, come in a variety of sizes. These different sizes affect the percent overhead associated with each flow. If the data flows through a HAIPE device with FPL enabled, there can be a significant impact to the percent overhead and realizable application data transfer rate. Because of this, the worksheet provides several sizes of acquisition data in order to show the impacts to overhead percentage and application data transfer rates between FTP enabled and disabled for the different sizes of acquisition data payloads.

### **SM**

System Management messages assume a single Simple Network Management Protocol (SNMP) request receives a single SNMP response. The SNMP protocol data unit in the request is considered the data to be transferred in this exchange. The entire response message is considered overhead in the calculations.

## APPENDIX 27-B

### Citations

Consultative Committee for Space Data Systems. *Low Density Parity Check Codes for Use in Near-Earth and Deep Space Applications*. Standard CCSDS 131.1-O-2-S. September 2007. Rescinded. Retrieved 17 May 2021. Available at <https://public.ccsds.org/Pubs/131x1o2e2s.pdf>.

Institute of Electrical and Electronics Engineers. *IEEE standard for Ethernet*. IEEE Std 802.3-2012. New York: Institute of Electrical and Electronics Engineers, 2012.

Internet Engineering Task Force. “Definition of the Differentiated Services Field (DS Field) in the IPv4 and IPv6 Headers.” RFC 2474. Updated by RFC 3260, RFC 3168, and RFC 8436. December 1998. Retrieved 17 May 2021. Available at <https://datatracker.ietf.org/doc/rfc2474/>.

———. “Internet Protocol.” RFC 791. Updated by RFC 2474, RFC 6864, and RFC 1349. September 1981. Retrieved 17 May 2021. Available at <https://datatracker.ietf.org/doc/rfc791/>.

National Institute of Standards and Technology. “Establishing Wireless Robust Security Networks: A Guide to IEEE 802.11i.” SP 800-97. May be superseded by update. Retrieved 17 May 2021. Available at <http://nvlpubs.nist.gov/nistpubs/Legacy/SP/nistspecialpublication800-97.pdf>.

**\* \* \* END OF CHAPTER 27 \* \* \***

## CHAPTER 28

### RF Network Management

<b>Acronyms</b> .....	<b>28-iii</b>
<b>Chapter 28. RF Network Management</b> .....	<b>28-1</b>
<b>28.1 Introduction</b> .....	<b>28-1</b>
<b>28.2 RF Network Management Concepts and Definitions</b> .....	<b>28-2</b>
28.2.1 Data Link Layer Framing.....	28-2
28.2.2 RF Link Management .....	28-3
28.2.3 Epoch Structure.....	28-3
28.2.4 Transmission Opportunities .....	28-3
28.2.5 Guard Time .....	28-4
28.2.6 Traffic Engineering Queues .....	28-4
28.2.7 Handoff .....	28-4
28.2.8 Heartbeat .....	28-4
28.2.9 RF MAC Header Addressing.....	28-4
28.2.10 Timing.....	28-5
28.2.11 Virtual TxOps .....	28-5
28.2.12 Independent Operation.....	28-5
<b>28.3 RF Media Access Control Layer</b> .....	<b>28-5</b>
28.3.1 Epoch .....	28-6
28.3.2 Media Access Control Frame Structure .....	28-7
28.3.3 RF MAC Payloads .....	28-8
28.3.4 Frame Check Sequence.....	28-11
<b>28.4 Logical Link Control Layer</b> .....	<b>28-11</b>
28.4.1 TxOp Processing.....	28-11
28.4.2 Queue Management Processing.....	28-14
28.4.3 Link Metric Processing .....	28-14
28.4.4 Heartbeat Processing.....	28-15
<b>28.5 Tunnel Management</b> .....	<b>28-15</b>
28.5.1 Tunnel Connection.....	28-16
28.5.2 TSS Interface Initialization .....	28-17
28.5.3 Tunnel Operation .....	28-17
28.5.4 Tunnel Selection .....	28-18
<b>Appendix 28-A. Documentation of TunTap Device Driver for Linux</b> .....	<b>A-1</b>
<b>Appendix 28-B. Documentation of TunTap Project for macOS</b> .....	<b>B-1</b>
<b>Appendix 28-C. Citations</b> .....	<b>C-1</b>

### List of Figures

Figure 28-1.	OSI Model as Related to the Telemetry Network Standard (TmNS) RF Network.....	28-1
Figure 28-2.	Data Link Layer Framing Overview.....	28-3
Figure 28-3.	Typical Epoch Structure .....	28-6
Figure 28-4.	MSDU Insertion into RF MAC Frame .....	28-8
Figure 28-5.	Fragmentation/Packing Sub-Header .....	28-10
Figure 28-6.	Notional Diagram of RF MAC Frame Containing Two MSDU_Blocks .....	28-10

### List of Tables

Table 28-1.	RF MAC Header Vendor IDs .....	28-5
Table 28-2.	Definition of Fields in Fragmentation/Packing Sub-Header .....	28-9
Table 28-3.	Default Interface Values for TSS Server Interfaces .....	28-17

## Acronyms

AES	Advanced Encryption Standard
BSN	block sequence number
CCMP	Counter with Cipher Block Chaining Message Authentication Code mode Protocol
FCS	frame check sequence
FPSH	fragmentation/packing sub-header
GPS	Global Positioning System
IETF	Internet Engineering Task Force
IP	Internet Protocol
LLC	logical link control
MAC	media access control
MDL	Metadata Description Language
ms	millisecond
MSDU	MAC service data unit
OSI	Open Systems Interconnection
QoS	Quality of Service
RF	radio frequency
RFC	Request for Comment
RFNM	radio frequency network message
SDU	service data unit
TCP	Transmission Control Protocol
TE	Traffic Engineering
TLV	Type Length Value
TmNS	Telemetry Network Standard
TSS	TmNS Source Selector
TxOp	transmission opportunity
UDP	User Datagram Protocol

This page intentionally left blank.



## CHAPTER 28

### RF Network Management

#### 28.1 Introduction

This chapter defines the mechanisms and processes for managing radio frequency (RF) links with the RF network. The RF network implements an Open Systems Interconnection (OSI) model approach (Figure 28-1) to data transmission, where data moves through the OSI stack from the application layer to the physical layer, from physical layer to physical layer through some transmission medium, then back up the stack to another application on the receiving side. For the most part, the RF network operates just like any other Transmission Control Protocol (TCP)/Internet Protocol (IP) network, where a message is created using a standard data management protocol, such as Simple Network Management Protocol; is encapsulated at the transport layer to TCP or User Datagram Protocol (UDP); and then is further encapsulated into an IP packet that contains the logical addressing and path routing determination. Where the RF network differs from the standard OSI model is in the data link and physical layers, where media access controls (MACs) have been modified to support transmission over RF links.

OSI Model				
	Layer	Data Unit	Function	Examples
Host Layers	7. Application	Data	High Level APIs, including resource sharing, remote file access, directory services and virtual terminals	HTTP, FTP, SNMP, SSH, TELNET
	6. Presentation		Translation of data between a networking service and an application, including character encoding, data compression and encryption/decryption	HTML, CSS, GIF
	5. Session		Managing communications sessions, i.e. continuous exchange of information in the form of multiple back-and-forth transmissions between two nodes	RPC, PAP, SSL, SQL
	4. Transport	Segments/Datagram	Managing communications sessions, i.e. continuous exchange of information in the form of multiple back-and-forth transmissions between two nodes	TCP, UDP, NETBEUI
Media Layers	3. Network	Packet	Structuring and managing a multi-node network, including addressing, routing and traffic control	IPv4 IPv6, IPSec, Apple Talk, ICMP
	2. Data Link	Frame	Reliable transmission of data frames between two nodes connected by a physical layer	PPP, IEEE 802.2 L2TP, MAC, LLDP
	1. Physical	Bit	Transmission and reception of raw bit streams over a physical medium	Ethernet physical layer, DSL USB, ISDN, DOCSIS
				<b>Covered by this chapter</b>
				<b>IRIG 106 Chapter 27</b>

Figure 28-1. OSI Model as Related to the Telemetry Network Standard (TmNS) RF Network

The RF network manages communications at the data link and physical layers of the OSI model. This chapter focuses on the RF network with respect to managing the data link layer of the OSI model. The RF network is a multi-node network with a network layer control and data plane. The control plane for managing the RF link layer multiple access is described in this document. For information on the physical layer of the RF network, refer to Chapter 27. The RF network’s control plane uses the existing ground network and adds RF connectivity to allow changes to RF transmission and capacity allocation in transceivers during missions. Radios need not establish direct bidirectional links with other transceivers in order to be part of the RF network. Rather, they are part of the network based on the principles and standards associated with normal IP routing protocols and need only support one or more paths to and from the overall RF network.

The RF network media access utilizes an epoch-structure transmission scheme. Management of the epoch schedule is coordinated through the interfaces defined in this document.

In order to support dynamic updates to the epoch structure, transceivers update their currently active policies based on RF network messages. These messages define when the transceiver has been given authority to transmit. This chapter covers the setting of transmission opportunities (TxOps) and the associated supporting RF network messages, which are defined in [Chapter 24](#). The end product of the link layer control plane messaging is the coordinated definition of the start and stop times associated with transmit opportunities in the RF network. An overview of the RF network's link layer concepts is given in Section [28.2](#).

When coordinating the transmission of multiple transmitting entities, it is the responsibility of RF link management to sequence the sending of TxOp messages and check for feedback of assigned TxOps from the transmitting entities in order to avoid multiple concurrent uses of the channel by multiple transmitters as required by range policy. The TxOps are assigned with either a finite or an infinite timeout value. An example of an epoch structure of an RF network is given in Section [28.3](#).

A specific RF link manager implementation performing the RF link management function and the transceivers being managed are all RF network components and should provide the interfaces covered in Chapters 22 through 25.

The bit numbering, bit ordering, and byte ordering conventions used in this chapter are described in [Chapter 21](#) Appendix 21-B.

## 28.2 RF Network Management Concepts and Definitions

### 28.2.1 Data Link Layer Framing

The RF network provides a standards-based IP network (Internet Engineering Task Force [IETF] Request for Comment [RFC] 791<sup>1</sup> and RFC 2474<sup>2</sup>). Layers supporting this IP layer are unique to the TmNS RF network. [Figure 28-2](#) shows an overview of the protocol layers associated with sending an IP packet over the data link layer and RF physical interface. The IP packets are referred to as MAC service data units (MSDUs) and are comprised of complete IP packets containing user data. The MSDUs are placed into payload blocks with aggregation and fragmentation performed to meet the maximum transmission unit of the RF channel. Advanced Encryption Standard (AES)-Counter with Cipher Block Chaining Message Authentication Code mode Protocol (CCMP) encryption may be used to provide added security on the RF link by encrypting the payload blocks. The length-limited payload blocks are separated into RF MAC frames and link layer header information is added. Forward error correction is added to the RF MAC frames to create LDPC blocks suitable for transmission over the RF interface. Details of the lower levels of this protocol are covered in [Chapter 27](#).

---

<sup>1</sup> Internet Engineering Task Force. "Internet Protocol." RFC 791. Updated by RFC 2474, RFC 6864, and RFC 1349. September 1981. Retrieved 17 May 2021. Available at <https://datatracker.ietf.org/doc/rfc791/>.

<sup>2</sup> Internet Engineering Task Force. "Definition of the Differentiated Services Field (DS Field) in the IPv4 and IPv6 Headers." RFC 2474. Updated by RFC 8436, RFC 3260, and RFC 3168. December 1998. Retrieved 17 May 2021. Available at <https://datatracker.ietf.org/doc/rfc2474/>.

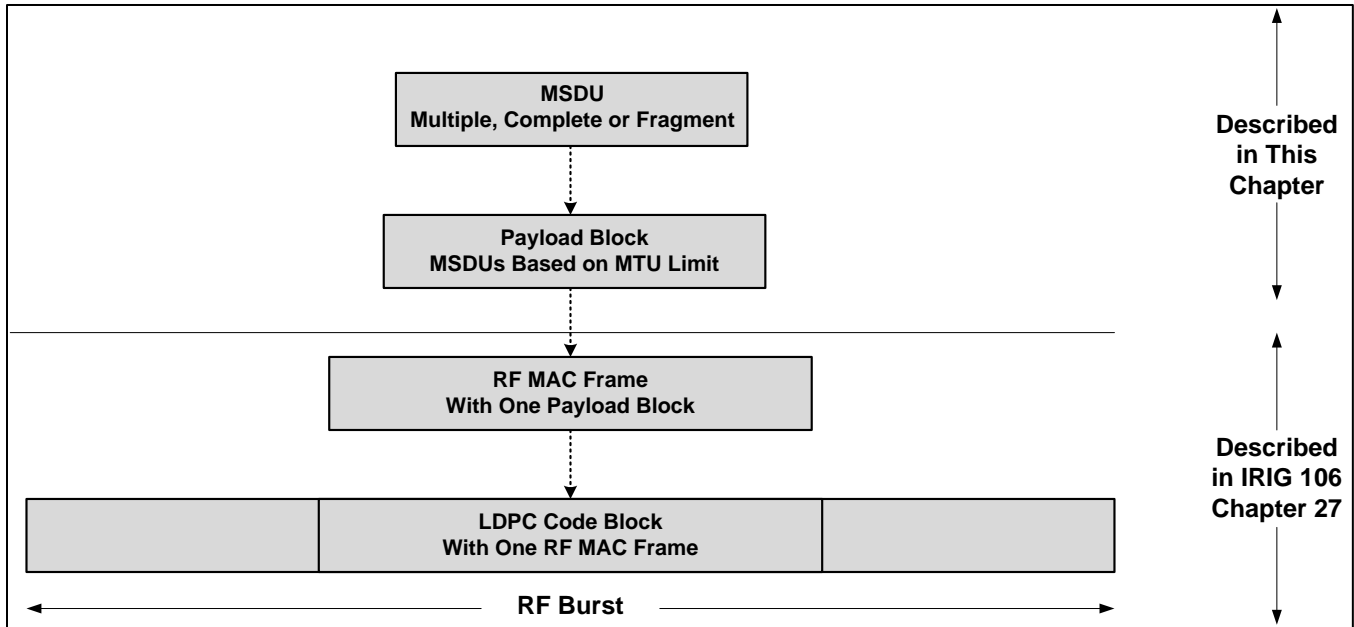

Figure 28-2. Data Link Layer Framing Overview

### 28.2.2 RF Link Management

The RF link management is responsible for scheduling RF transmissions in TmNS radios. Time synchronization is critical to the orchestration of the scheduling. The RF link management also performs route selection for packets transiting from the wired networks to the RF networks.

There is at least one RF link management source associated with a ground station. The RF link management on the range may be controlling one or more transmitting entities on the ground. The RF link management also controls transmitting entities that are networked through the ground network, such as those contained on test articles.

The RF link management provides a set of control protocols for managing a transmitting entity's RF spectrum access. These protocols include:

- Transmission scheduling
- RF transmission capacity management
- Handoff management
- Power management - TBD
- Link and RF Traffic Loading Status

### 28.2.3 Epoch Structure

The RF network implements an epoch structure to provide an efficient utilization over a shared bandwidth. Link management messages support dynamic adjustment of the epoch structure being utilized by components comprising an RF network.

### 28.2.4 Transmission Opportunities

A TxOp is a window in time over which a transmitting entity may transmit over its associated RF interface. The TxOp contains a start time and stop time that is relative to a repeating time boundary that is referred to as an epoch. The epoch is settable to a number of discrete times during initialization.

### 28.2.5 Guard Time

Guard time is the time utilized by an overall RF network epoch schedule to assure clock jitter and RF propagation delays do not create undesired RF collisions. There are no RF network messages associated that specify guard time. Rather, the TxOps that are allocated to components within an RF network should be set up in a fashion in order to support the desired guard time. [Chapter 23](#) specifies an interface for communicating guard time to an RF link manager component. Default guard time is recommended to be 1 millisecond.

### 28.2.6 Traffic Engineering Queues

The RF network components that are intended to behave as IETF IP routers shall provide Quality of Service (QoS) handling of traffic that is delivered to the RF interface. The QoS interface is implemented in the form of Traffic Engineering (TE) queues. As such, the behavior concerning the ingress and subsequent egress (or in overload situations, drop) of messages shall comply with the details specified in [Chapter 22](#).

### 28.2.7 Handoff

Handoff is a process by which the RF path is changed to use a different RF network interface. In this way, the route (path) of RF propagation that is experiencing undesired receive RF quality can be directed to a different path. This updated path (post-handoff) will be through a different RF network interface that may be in the current RF network or it may include switching to another RF network. This chapter does not provide a particular mechanism for performing handoff operations but rather a sequence of use of RF management interfaces that can accomplish a variety of handoff operations.

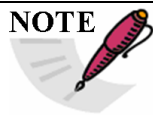

#### **NOTE**

It is expected that handoff will be performed when a test article transceiver begins to move out of range of a ground antenna, moves from one RF network to another, or moves from one range to another. This chapter does not specify a policy for when a handoff is to be performed. It can be automatically or manually directed.

### 28.2.8 Heartbeat

The Heartbeat mechanism defines a relative time to automatically cease transmissions and clear all TxOps from the transmission schedule for a transmitting entity. The initial heartbeat value shall be loaded from a Metadata Description Language (MDL) configuration file, and the value shall be updated upon reception of an RF network message containing a Heartbeat Type Length Value (TLV). Reception of an RF network message containing a Heartbeat TLV from RF link management that is directed to any RF network interface on the receiving transmitting entity will refresh the heartbeat counter for all RF network interfaces (e.g., links) on which the transmitting entity is processing TxOps. Links are defined in Subsection [28.2.9](#).

### 28.2.9 RF MAC Header Addressing

An RF MAC address source/destination pair that defines the endpoint of an RF transmission is called a “link”. Links are individually managed, including scheduled, by the RF link management.

The RF MAC address shall be a 16-bit value subdivided into a Vendor ID field (most significant 4 bits) and an RF Interface field (least significant 12 bits), whereby the Vendor ID field uniquely identifies the manufacturer and the RF Interface field further uniquely identifies

an RF component produced by that manufacturer. One of the Vendor ID fields is reserved for RF multicast group addresses. [Table 28-1](#) displays RF MAC header vendor IDs.

<b>Vendor IDs</b>	<b>Description</b>
4'b0000	Reserved
4'b0001– 4'b1101	Vendors
4'b1110	Experimental
4'b1111	Multicast

The assignment of a unique Vendor ID value to each manufacturer is outside the scope of this chapter. Manufacturers are responsible for ensuring the uniqueness of the RF MAC address space of the components they produce.

#### 28.2.10 Timing

The RF link management and all entities under its control shall have their clocks synchronized. Methods of time synchronization are defined in [Chapter 22](#). The format of the time in RF network messages is defined in [Chapter 24](#).

#### 28.2.11 Virtual TxOps

When a transmitting entity does not have any TxOps allocated for the current or any future epochs, a Virtual TxOp time slot shall be available for responding to link layer control plane TCP connection over the RF interface. The Virtual TxOp shall be a single burst in size and shall be located at the beginning of each Global Positioning System (GPS) second. This allows the RF link management to receive return messages from a transmitting entity in the exchange of TCP control messaging after which time a TxOp Assignment TLV can be sent to the transmitting entity in order to maintain long-term communications.

	<p><b>NOTE</b> The RF link management uses a TCP connection that requires a bidirectional handshake to occur before TxOp Assignment TLVs can be received. The use of the Virtual TxOp transmission allows standard TCP methods to establish the link layer control path without using unprotected messaging.</p>
---	--

#### 28.2.12 Independent Operation

An RF network shall be capable of operating independent of RF link management control. In this mode of operation, TxOp allocations are the result of configuring with an MDL file that contains the transmission schedule. A heartbeat value of infinite allows TxOp assignments to remain in effect indefinitely, assuming the TxOp timeout value remains greater than zero, or until RF link management changes the value by sending a non-infinite heartbeat value in a Heartbeat TLV. The transmitting entity operating independent of RF link management as described shall allow RF link management control to take over independent operations. An independent transmitting entity allows externally received Heartbeat TLVs and TxOp Assignment TLVs to overwrite MDL-provided values.

### 28.3 **RF Media Access Control Layer**

The RF MAC layer is responsible for providing access to the physical media (i.e., the wireless RF network). On the transmission side, it is responsible for framing IP packets for

physical transmission (adding in the layer 2 hardware addresses for the source/destination pair of the link). On the receive side, it is responsible for validating the checksum sent with each packet (known as the frame check sequence [FCS]) and de-framing the received packet.

### 28.3.1 Epoch

The RF channel will be supported by an epoch structure to separate transmission signals. It emulates full-duplex communication over a half-duplex link and is utilized by the TmNS RF network. The transmitting entity shall synchronize the epoch start time with a commonly referenced external time synchronization mechanism that is common to the RF network.

#### 28.3.1.1 Epoch Structure

An epoch structure shall contain an integer multiple of TxOp assignments. The number of TxOps and their durations are assigned according to the need and policy that has been put in place by RF link management. [Figure 28-3](#) depicts an example of a schedule with four transmitting entities in a network with TxOps to access the RF network.

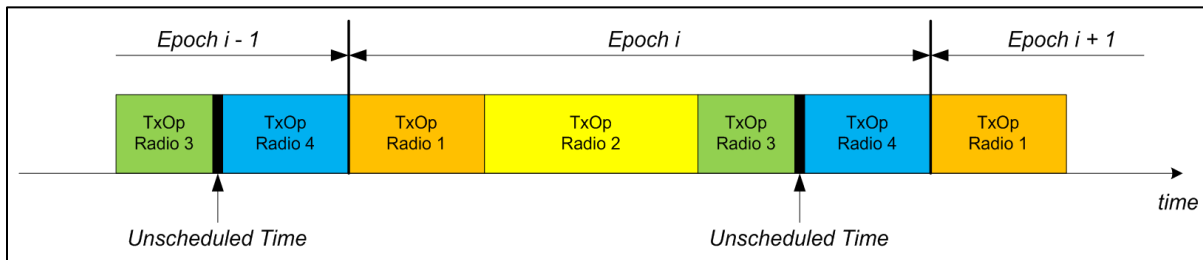



Figure 28-3. Typical Epoch Structure

Transmitting entities in the network are only aware of the start and stop times of a TxOp, and it is the responsibility of RF link management to provide unscheduled time in order to provide sufficient guard times when scheduling TxOps. For times other than the assigned TxOp periods in an epoch, a transceiver shall transition to receive mode, i.e., capable of receiving transmissions destined for it. When there are no packets ready to be transmitted when a scheduled TxOp period occurs, the transmitting entity shall not transmit. A detailed description of the TmNS RF burst sequence requirements for the transmitting entity can be found in [Chapter 27](#).

#### 28.3.1.2 Epoch Timing

The duration of the epoch frame period shall be constrained to the following allowable values: 1000 ms (maximum epoch size), 500 ms, 250 ms, 125 ms, 100 ms (default epoch size), 50 ms, 40 ms, 25 ms, 20 ms, 10 ms (minimum epoch size). Epoch size for a transmitting entity shall only be set during configuration through the MDL configuration file. It is not required that RF link management update the allocated capacity at the same rate as the epoch period used in the RF network. Epochs shall be aligned with time-synchronized seconds as defined in [Chapter 22](#) corresponding with a transition between two adjacent epochs.

 <p><b>NOTE</b></p>	<p>While this chapter allows for different components within an RF network to be configured with different epochs, it is expected that all epochs will be the same.</p>
--	---

### 28.3.1.3 Guard Times

Between TxOp allocations, a period of no transmissions referred to as a guard time may be provided by RF link management or independent MDL configuration to allocate time between transmissions. Guard times also can be used to account for RF propagation delays across the range. It is the responsibility of the RF link management to provide guard times between the TxOps that it allocates. Guard times are intentional gaps in the epoch structure in which no transmitting entity has a TxOp.

### 28.3.1.4 Transmission Opportunity

The use of TxOps provides a mechanism of provisioning coordinated channel capacity across multiple transmitting entities on an RF network based on the policies in place for the range. To access the RF media, one or more TxOps is assigned to a transmitting entity. A single TxOp is the authority of the transmitting entity to transmit to its RF interface between two time periods, referred to as start and stop times. The start and stop times of a TxOp are defined relative to a recurring epoch start time. The epoch start time of a transmitting entity should be synchronized with GPS seconds or external time synchronization as defined in [Chapter 22](#).

Each TxOp has a defined destination RF MAC address (e.g., link) that is set to the RF MAC address of an individual transceiver or an RF multicast group address. Transceivers can be set to listen on one or more multicast addresses in addition to their RF MAC address. Multiple TxOps can be assigned to a transmitting entity that are for the same, different, or a combination of RF MAC addressed destinations.

If a transmitting entity does not have sufficient data to generate burst sequences that completely fill a TxOp, then it may cease transmission after all needed burst sequences have been transmitted, i.e., a transmitting entity is not required to pad to fill a TxOp.

If a transmitting entity has ceased transmission in a TxOp and more data becomes available to be transmitted while there is sufficient time remaining in the TxOp both to allow the minimum time between transmissions and to transmit one or more complete burst sequences, then the transmitting entity shall resume transmission, transmitting one or more contiguous burst sequences.

 <p><b>NOTE</b></p>	<p>The timeout value in the TxOp TLVs allows epochs of transmissions and not each transmission to be scheduled. This relaxes the requirement of RF link management processing and supporting network speed. Prior to the addition of the timeout functionality, the RF link management was required to generate the complete network complement of RF network messages containing TxOp TLVs and transfer them to the transmitting entities, meeting tight setup times, each epoch for proper RF data plane management.</p>
--	--

## 28.3.2 Media Access Control Frame Structure

The MAC frame structure determines what RF transmissions are received. The RF MAC filters received traffic, accepting only those RF transmissions that the receiving entity is interested in receiving.

### 28.3.2.1 Header Format

Frame headers for RF MAC control frames contain the destination, source, and a length. The destination address is either an RF MAC address of the destination transceiver or an RF

multicast address that specifies the RF multicast group that receiving entities can listen to. The source address is always the RF MAC address of the transmitting entity. A length is included that indicates the length of the MAC payload in the MAC frame. Additional information about the RF MAC frame format can be found in [Chapter 27](#).

### 28.3.2.2 Unprotected Payload

All link layer control frames are contained in secure TCP payload streams with only the RF MAC layer header including the source and destination sent unprotected. The FCS is also sent unprotected to allow for physical layer verification of a correctly received frame.

### 28.3.2.3 Protected Payload

The link layer control frames are contained in TCP secure IP packets. These frames contain RF network messages to control transmissions on the RF network. If AES encryption is used, then the secure TCP packets will have an additional level of encryption.

### 28.3.3 RF MAC Payloads

The MSDUs are received from upper protocol layers by the RF link layer and are aggregated, fragmented, or directly placed into payload blocks. The payload blocks have a fragmentation/packing sub-header (FPSH) header added to preserve the original MSDU shape when reconstruction is performed at the link layer on the receiving end. The combined payload block and FPSH header are then encapsulated either encrypted or unencrypted into the RF MAC frame described in [Chapter 27](#). This is shown in [Figure 28-4](#).

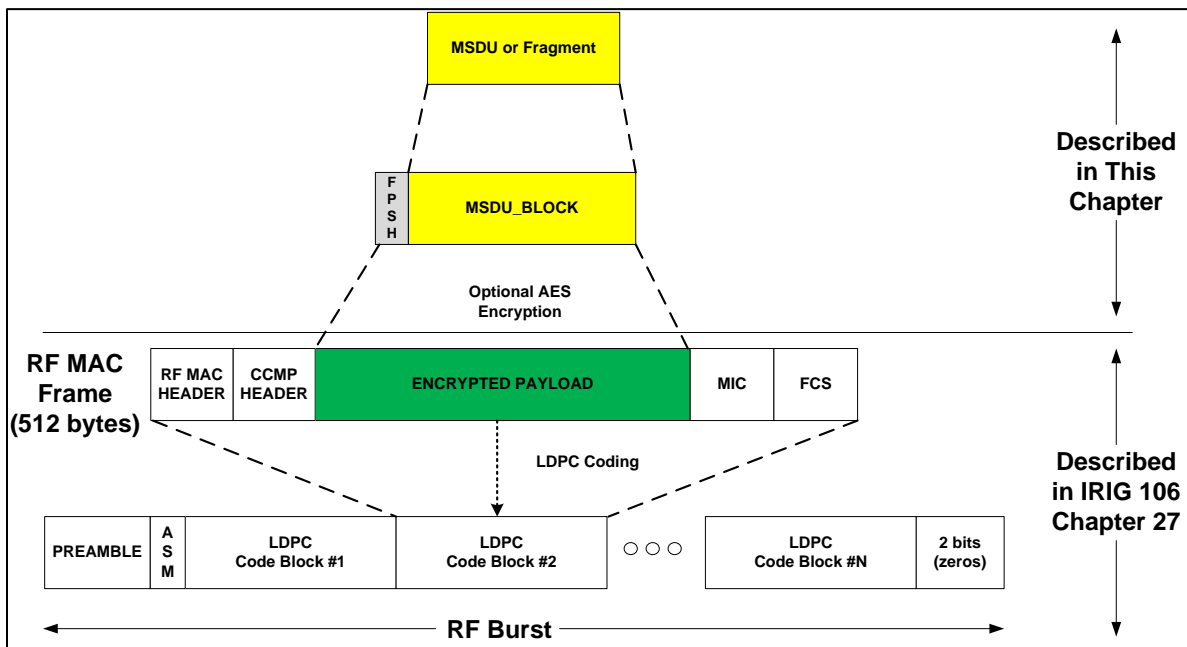

Figure 28-4. MSDU Insertion into RF MAC Frame

### 28.3.3.1 RF MAC Service Data Units

The RF MAC service data units (MSDUs) are portions of messages to be transmitted across the RF link. The MSDUs are placed into blocks with aggregation and fragmentation performed.



### 28.3.3.2 RF MAC Frame Fragmentation

If an IP packet is too long to fit into an RF MAC frame, then it is fragmented, which is the process by which an RF MSDU is divided into one or more MSDU\_Blocks. An MSDU\_Block contains a full MSDU or a fragment of an MSDU. The fragmentation process is undertaken to allow efficient use of available payload in an RF MAC frame. Capabilities of fragmentation and reassembly are required. Fragments are tagged with their position in their parent SDU in accordance with the values defined for the Fragmentation Control field shown in [Table 28-2](#).

<b>Table 28-2. Definition of Fields in Fragmentation/Packing Sub-Header</b>		
Field	Width (Bits)	Description
FC	2	Fragmentation Control Indicates the fragmentation state of the payload MSDU: 00 = no fragmentation 01 = last fragment 10 = first fragment 11 = continuing (middle) fragment
Reserved	3	Reserved
BSN	11	Block sequence number (BSN) for this MSDU_Block [0 ... 2047] modulo 2048
Priority	3	Priority ranking for this MSDU_Block
Length	13	Length (in bytes) of this MSDU_Block, including this six-byte FPSH [7 ... 500]
Protocol	16	Type of Protocol Use standard Ethernet values
TOTAL	48	

Multiple short RF MSDUs and/or fragments of RF MSDUs can be packed in the same RF MAC frame. Capabilities of packing and unpacking are required. When an RF MSDU is not fragmented, the Fragmentation Control field in the FPSH shall be set to 00 (“No Fragmentation”).

An FPSH precedes each fragment or packed entity. Each fragment or packed message is itself an MSDU\_Block. The FPSH structure is depicted in [Figure 28-5](#).

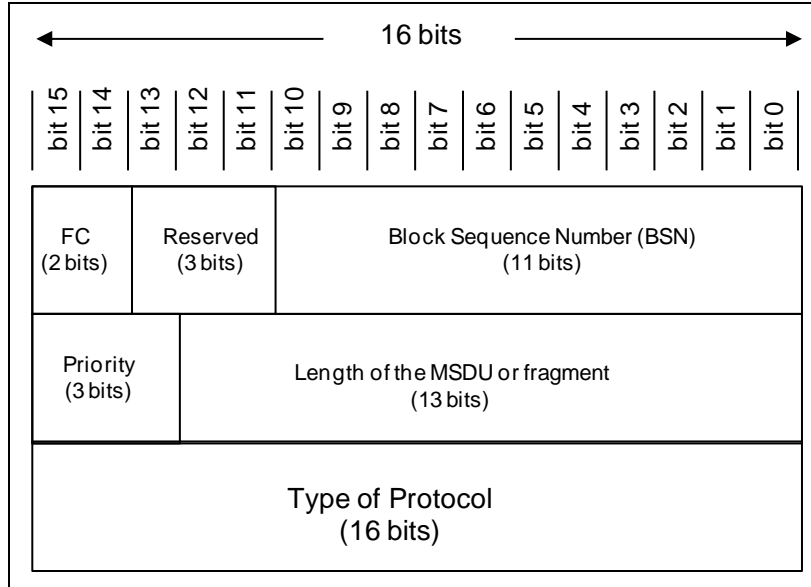

Figure 28-5. Fragmentation/Packing Sub-Header

The MSDU\_Block size shall be variable with a maximum of 494 bytes in an unprotected RF MAC frame and 478 bytes in an RF MAC frame protected with AES-CCMP encryption.

The link layer control messages described in this document are sent within standard IP packets that are marked as IP type in the Protocol field.

If an RF MAC frame has a payload field, the payload shall comprise one or more MSDU\_Blocks each with its associated FPSH. See the notional diagram in [Figure 28-6](#).

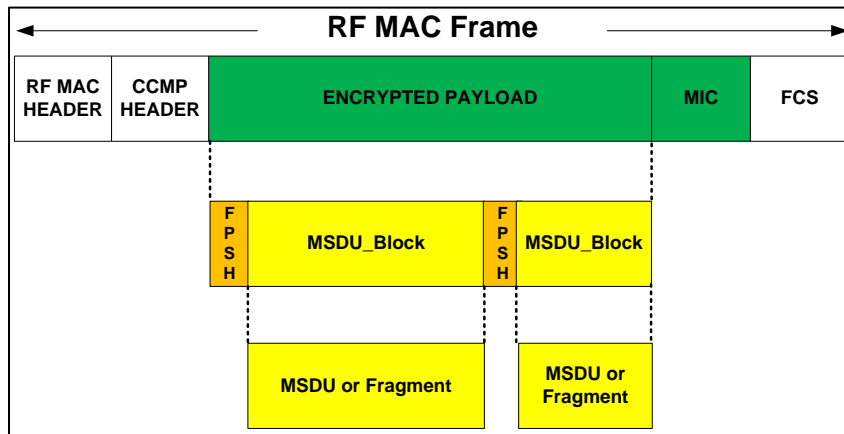

Figure 28-6. Notional Diagram of RF MAC Frame Containing Two MSDU\_Blocks

Whenever possible, the payload of an RF MAC frame shall be completely filled. This may necessitate fragmenting the next MSDU that is to be transmitted.

If there are 6 bytes or fewer remaining in a payload, the remaining bytes shall be padded with zeroes. The length field in each FPSH tells the size of the following MSDU\_Block.

If an MSDU is fragmented into multiple MSDU\_Blocks, the multiple MSDU\_Blocks shall be transmitted in the same order in which they occurred in the MSDU and shall have BSNs that are consecutive integers, modulo the BSN modulus.

If an MSDU is fragmented into multiple MSDU\_Blocks and all the MSDU\_Blocks are not transmitted in a single TxOp, then the remaining MSDU\_Blocks should be the first new MSDU\_Blocks sent at this priority level. When MSDU\_Blocks are available for more than one priority level, MSDU\_Blocks marked with the higher numeric priority values shall be chosen over lower numeric priority values.

#### 28.3.4 Frame Check Sequence

The FCS contained at the end of an RF MAC frame shall serve as a link layer error-checking mechanism. The FCS generation and verification is covered in [Chapter 27](#). Additionally, the higher-layer protocols (e.g., IP checksums) perform their own error checking.

### 28.4 **Logical Link Control Layer**

The logical link control (LLC) layer of the RF network provides media access control and transfer of data frames. The LLC layer provides the control mechanisms for dynamically managing transmission bandwidth.

Epoch-based RF link management is accomplished by sending RF network messages to the transmitting entities to modify the current transmission schedules.

 <p><b>NOTE</b></p>	<p>All RF link management messages are sent using a secure TCP connection with the transmitting entity. Details of secure connections are provided in <a href="#">Chapter 22</a> Subsection 22.4.3.</p>
---	---

The RF network messages are sent with IP Precedence as defined in [Chapter 22](#) Subsection 22.5.3.2.

An RF network message may contain multiple types of TLVs. When an RF network message contains multiple TLVs, each TLV shall be processed in the order in which they are packed.

#### 28.4.1 TxOp Processing

The external loading of a schedule of TxOps from external MDL shall be equivalent to receiving a sequence of RF network messages with TxOp Assignment TLVs. An export of a transmitting entity's configuration in MDL shall include all the currently scheduled TxOps regardless of whether they originate from TxOp Assignment TLVs in RF network messages, an MDL configuration file, or a combination of both input sources. The transmitting entity shall allow TxOp Assignment TLVs received in RF network messages to modify existing scheduled TxOps, including those initially set during configuration with an MDL file.

A TxOp assignment for a transmitting entity may be different in each epoch, and multiple TxOp Assignment TLVs for use in a single epoch may be sent in the same RF network message from RF link management. Received TxOps shall take effect within two complete epoch start times after reception. For each allocated TxOp in a transmitting entity's schedule, the transmitting entity shall send a status RF network message containing TLVs with both information on all QoS transmit queue levels and receiver link quality to RF link management.

An RF network message containing one or more TxOp Assignment TLVs can be sent by RF link management and likewise be received at any time during the epoch by a transceiver. TxOp Assignment TLV adjustments are state-based, that is they adjust the epoch schedule based on top of all prior adjustments that were accomplished. A TxOp Assignment TLV can add, remove, or modify an existing TxOp window for transmissions. A modification of a currently active TxOp Assignment TLV occurs when a new TxOp Assignment TLV completely subsumes an existing TxOp. The start time of the new subsuming TxOp should be equal to or earlier than the existing TxOp and the stop time should be equal to or greater than the existing TxOp.

The TxOp Assignment TLV also contains a timeout value that specifies the lifetime of the TxOp as measured in epochs. The timeout value can be zero, which will result in the removal of one or more TxOps that are completely subsumed by the TxOp Assignment TLV received regardless of their former timeout values. If the timeout value is infinity, which is defined as the value 255, the TxOp defined by the received TLV is put in place with no epoch-based timeout, and it shall replace all TxOps that are subsumed by the start and stop times of the TxOp TLV.

The TxOp Assignment TLVs are associated with a particular RF link that is a source and destination pair of RF MAC addresses that identifies the source, e.g., the radio that is to use the particular TxOp, and the destination RF MAC address to which it is to transmit. Any transmitting entity that transmits to multiple destination groups shall have separate TxOp Assignment TLVs sent to it in order to differentiate which RF interface is being allocated for transmission. The associated link is contained in the RF network message header.

Each time the transmission schedule of a transmitting entity is updated, it shall report to RF link management with an RF network message containing a TxOp ID Acknowledgement Report TLV. The report shall be generated after the new schedule has been applied. The report may be generated in the epoch prior to the first use of the associated TxOp if the relative start time and stop time have already occurred within the current epoch if the new TxOp will be first utilized during the next epoch. The TxOps with ID values of zero (16'h0000) shall not be acknowledged by transmission entities. The TxOp ID Acknowledgement Report TLVs are not specific to the particular source and destination RF MAC addresses contained in the message header of the RF network message containing the TLV. If the RF network message only contains the TxOp ID Acknowledgement Report TLV, then the RF network message header shall use its own RF MAC address as the source address and destination address.

**NOTE**

The TxOp ID Acknowledgement report TLVs should be sent as soon as possible after the new schedule has been applied to ensure responsiveness to scheduling needs. The schedule is considered “applied” if it will be utilized at the next occurrence of the relative start time, regardless of whether the next occurrence of the TxOp start time is in the current epoch or will be in the next epoch.

A transmitting entity may only transmit over a particular RF interface at the frequency and for the epoch-based periodic time slot that has been specified in a valid TxOp Assignment TLV. Any time a TxOp is executed, the frequency of the transceiver is set according to the associated frequency value that was specified in the corresponding TxOp Assignment TLV, and transmission is allowed for the duration of the TxOp. If a TxOp Assignment TLV’s start time is equal to its stop time (i.e., time duration is zero), it shall be considered a valid TxOp Assignment TLV.

 <p><b>NOTE</b></p>	<p>A zero-duration TxOp may be used to support handoff scenarios that involve a frequency change. That is, they provide a mechanism that supports commanding a transceiver to change its receiving frequency but does not give authority to transmit over the new frequency. Rather, a TxOp received on the new frequency from a different RF network management entity would then give authority to transmit.</p>
--	--

Each TxOp is given a lifetime in terms of the number of epochs that it is valid for. The lifetime may be updated before it expires on its own if a new TxOp Assignment TLV arrives with a start and stop time that completely subsumes an existing scheduled TxOp.

Multiple TxOp Assignment TLVs may be packed into a single RF network message if the associated TxOps are destined for the same source over the same RF interface (link).

Because start and stop times are relative to the size of the epoch, a time window equal to the size of the epoch is used to define when the start time and stop time in a TxOp Assignment TLV are considered to be valid. The TxOp Assignment TLVs that define TxOps falling outside this window shall be discarded.

Because the start and stop times of TxOps are quantized values (limited to integers that represent microseconds within an epoch), the start time shall correspond to times greater than or equal to the time represented by the value of the start time field. The stop time shall correspond to the exact instance of the greatest value that is less than the stop time field plus 1. Thus, the valid transmission time associated with a TxOp shall be according to the following equation:

$$t_{start} \leq \text{valid transmission range} < t_{stop} + 1$$

If the start time of one TxOp is equal to the stop time + 1 of the previous TxOp, the TxOps can be called back-to-back TxOps. From a transmitter's perspective, back-to-back TxOps allow continual transmission without a requirement to turn off the transmitter power prior to the conclusion of the first TxOp.

From a transmitting entity's perspective of the system, each time an epoch is processed, all scheduled TxOps that contain a non-zero timeout value will be executed. After execution, the timeout value associated with that TxOp will be decremented by one unless it is an infinite TxOp with a timeout value of 255. Once the timeout value of a TxOp reaches the value of zero, it is removed from any future processing. For infinite TxOps, the timeout does not decrement after execution.

#### 28.4.1.1 TxOp Processing After Power Interruption

In the event of power interruption, the transceiver shall configure itself to receive using the relevant parameters of the last processed TxOp or the configuration data from the last loaded MDL configuration file, whichever occurred more recently. If no valid TxOps exist, it shall be assumed that no transmission slots are allocated to it for the next epoch. The transceiver shall continue to perform its receiver functionality.

 <p><b>NOTE</b></p>	<p>In the event of a power interruption, the transceiver should store its current TxOps and associated timeout values. After booting back up, the transceiver shall resume transmissions if the TxOps have not timed out and the transceiver's</p>
--	--

heartbeat timeout is not zero. This can be determined by calculating the number of epochs that have passed since the reboot event. The transceiver should still obtain time synchronization prior to executing any TxOps.
---

#### 28.4.1.2 TxOp Processing When Heartbeat Times Out

If the timeout value for the last received heartbeat from RF link management expires before the receipt of the next heartbeat, the transceiver shall flush all scheduled TxOps with a remaining non-zero timeout value that was received.

Any new TxOp Assignment TLVs that are received whose current heartbeat timeout value is zero shall be discarded. A non-zero heartbeat timeout is required in order to process new TxOp Assignment TLVs.

See Subsection [28.4.4](#) for more information regarding Heartbeat TLVs.

#### 28.4.2 Queue Management Processing

For each TxOp used by a transmitting entity, a MAC Queue Status Report TLV (type 3) and TE Queue Status Report TLV (type 10) shall be generated by the transmitting entity for the link associated with the TxOp. These TLVs provide the state of traffic loading in the MAC and TE queue interface to the RF channel as defined in this chapter as well as [Chapter 22](#), [Chapter 23](#), [Chapter 24](#), and [Chapter 27](#). Generation of the RF network messages containing these TLVs shall be accomplished once per TxOp. Transmitting entities shall add this RFNM to the appropriate outgoing TE queue at the start of the TxOp. These chapters specify that there are eight TE queues, each of which corresponding to a specific IETF Precedence Class as summarized by the table contained in [Chapter 22](#). [Chapter 23](#) defines the TE queue to IETF class mapping and also includes details of the MDL grammar that provides a method to define user-specific per hop behaviors for a mission and how they apply to each of the TE queues (Precedence Classes). Transmitting entities shall comply with the QoS concepts defined in this chapter, [Chapter 22](#), [Chapter 23](#), and [Chapter 27](#) by selecting MSDUs to send when a TxOp occurs based on the overall policy that has been specified through MDL. This selection process is therefore the overall configured policy for the mission and specifies the behavior choice process that is to be used across the TE queues. As long as time within the TxOp remains, further messages shall be sent based on the TE queue policies until the TxOp is over.

#### NOTE



Because an RF network message (RFNM) is an IP packet, there is no guarantee that it will be the first packet transmitted during the TxOp; however, due to the high Differentiated Services Code Point marking of the RFNM, it is expected to be transmitted very early with the TxOp window.

#### NOTE



It is expected that typical RF link management uses a combination of instantaneous historical queue status TLVs to determine potential adjustment to link layer TxOp allocations.

#### 28.4.3 Link Metric Processing

The Link Metric TLV (type 6) is used to inform RF link management of the quality of the received data signal in the transceiver. Once a TCP connection is established between RF link management and the transceiver, the transceiver shall send Link Metric TLV(s) at a minimum of once every epoch.

The Link Transmit Statistics Report TLV (type 11) is used to inform RF link management of the RF transmission statistics in the transceiver for a link. The link is identified by the RFNM header of the message carrying the TLV. Once a TCP connection is established between RF link management and the transceiver, the transceiver shall send the Link Transmit Statistics Report TLV(s) at a minimum of once every epoch.

#### 28.4.4 Heartbeat Processing

The initial heartbeat value is obtained through configuration via an MDL configuration file. An RF network message containing a Heartbeat TLV shall be used to overwrite the current value of its heartbeat value.

The Heartbeat TLV, which is described in more detail in [Chapter 24](#), provides a numeric timeout value that represents the number of epochs in the future that the transmitting entity is authorized to execute TxOps. These TLVs are generated by the RF link management and sent to the transmitting entities. The timeout value of a newly received Heartbeat TLV shall replace the existing heartbeat timeout value. It is the responsibility of the RF link management to issue new Heartbeat TLVs before the heartbeat timeout expires. A transmitting entity whose heartbeat value has reached zero shall remove all active TxOps, and the transmitting entity shall not transmit further until it receives a non-zero heartbeat value, either from an RF network message with a Heartbeat TLV or through reconfiguration with an MDL configuration file.

While the heartbeat timeout value of a transmitting entity is zero, any newly received TxOp Assignment TLVs shall be discarded. A Heartbeat TLV may be sent in the same RF network message alongside TxOp Assignment TLVs. Because TLVs within an RF network message are processed in order, the Heartbeat TLV should be first before any TxOp Assignment TLV.

A heartbeat value is a global configuration parameter that affects all RF interfaces on the entity. Reception of an RF network message containing a heartbeat TLV from RF link management that is directed to any RF network interface on the receiving entity will refresh the heartbeat counter for all RF network interfaces (e.g., links).

Heartbeat values that are set to the value representing an infinite lifetime shall never expire; however, these values may be overwritten through RF network messaging as described above.

The current heartbeat value shall be provided in the MDL file produced by a transceiver during an MDL export operation.

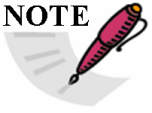
 <p><b>NOTE</b></p>	<p>In the event of a power interruption, the transceiver should store its current heartbeat timeout value. The heartbeat value should be used after the transceiver boots back up, but only after the proper number of decrements to the timeout are made. The number of epochs missed due to the transceiver being rebooted or powered off should be used to determine the proper number of decrements.</p>
--	--

## 28.5 Tunnel Management

Network tunnels provide a mechanism to ease the complexity of transporting TmNS-based data and command and control network packets across pre-existing networks. For example, routing, QoS, multicast delivery, and handoff can be supported by the tunnel, thereby

not requiring customized range IT solutions. These tunnels can be created, removed, and adapted through management functions.

Tunnel management provides support for multiple receiving entities of a single transmission in a seamless manner (message-selection-from-many). Doing this allows the network to appear as a packet funnel; that is, it makes the multiple packet receptions appear as a single packet reception. Likewise, tunnel management supports the selection of a particular transmitting entity from a set of possible transmitting entities (transmitter-selection) such that it can appear as a single continuous transmission stream, even in dynamic switching scenarios. Receiving entity message-selection-from-many is a process of allowing multiple receivers to receive the same RF transmissions from a single source. The selection portion chooses the first received packet and forwards it on to its destination while all duplicate packets received are discarded. The transmitter-selection portion of tunnel management allows for the dynamic switching of transmitting entities.

 <p><b>NOTE</b></p>	<p>Message-selection-from-many and transmitter-selection capabilities of tunnel management can be utilized on a range to support handoff. The message-selection-from-many choice can support a kind of packet-based source selection for the air-to-ground transmissions. The transmitter-selection involves the selection of the transmitting entity for delivering packets to the target network.</p>
--	---

Tunnel management shall be implemented by using virtual network interfaces, which appear just like any real network interface to the host operating system, but they can also be accessed by application programs. These virtual interfaces are commonly called “tuns” and are first-class interfaces in Linux-based operating systems. Implementations for Windows-based operating systems and macOS-based operating systems are also prevalent. Open-source examples of tun implementation are available on the Internet. The following links contain information regarding tuns for Linux, Windows, and macOS, respectively:

- <https://kernel.org/doc/Documentation/networking/tuntap.txt> (See [Appendix 28-A](#))
- <https://community.openvpn.net/openvpn/wiki/ManagingWindowsTAPDrivers>
- <http://tunaposx.sourceforge.net> (See [Appendix 28-B](#))

The overall process of using the virtual interfaces and tunnel selection process is a functionality referred to as the TmNS Source Selector (TSS) capability. The TmNS-compliant transceivers shall provide tuns that can be connected through TCP tunnels by RF link management. Likewise, RF link management shall provide tuns to connect to TmNS-compliant transceivers. These tuns are referred to as TSS interfaces. The TSS tunnels between TSS interfaces shall be implemented using Secure Sockets Layer over TCP. See [Chapter 22](#), Subsection 22.4.3 for more information on SSL and Subsection 22.4.1 for more information on TCP.

### 28.5.1 Tunnel Connection

A TSS client initiates a TCP connection to the TSS listening port on a TSS server in order to establish the connection to be used as the tunnel. The default port for listening to incoming TSS connections shall be 55000.



### 28.5.2 TSS Interface Initialization

Each time a TCP connection is established between a TSS client and the target TSS server, the TSS initialization sequence shall occur. Each tunnel end point shall follow its own initialization sequence.

#### 28.5.2.1 Initialization of TSS Server Interface

The TSS server shall create its virtual interface, apply interface properties to it, and then bring up the interface. Once the interface is up and active on the TSS server, it shall send its virtual interface properties through the tunnel to the connected TSS client. The interface properties shall be carried through TSS initialization messages, which are described in [Chapter 24](#) (including the order in which they shall be sent). The TSS initialization messages shall be the first messages sent through the tunnel. After these six messages are sent, any post-initialization operations, such as routing table updates, may be made.

The TSS interface parameter values for TSS servers may be initialized during configuration through MDL. Default values shall be used if not explicitly described in MDL during component configuration. Default values for a TSS server interface are shown in [Table 28-3](#).

<b>Table 28-3. Default Interface Values for TSS Server Interfaces</b>	
<b>Value</b>	<b>Description</b>
192.168.1.255	Broadcast address to associate with the TSS server interface
192.168.1.1	IP address to assign to this TSS server interface
55000	Port to listen on for incoming TCP connection
tap0	Name to give the TSS server interface
255.255.255.0	Netmask of the TSS server interface

#### 28.5.2.2 Initialization of TSS Client Interface

The TSS client shall create a separate virtual interface for each TSS server that a TSS client establishes a TSS tunnel with. The virtual interface shall have its interface properties applied, and then the interface shall be brought up. Once it is up, it shall listen for the six TSS initialization messages being sent from the TSS server interface of the connected TSS server. Once the six messages are received, the TSS client interface has been initialized. If the interface is to be immediately available for routing, a post-initialization routing rule should be added to the TSS client's routing table.

### 28.5.3 Tunnel Operation

From the RF link management perspective, transmitter-selection IP routing shall be performed by writing to only one of the tunnels associated with the destination IP address. Message-selection-from-many shall use the Cyclic Redundancy Check field of the TSS data message in order to identify duplicated received packets. For message-selection-from-many, the first instance of a received IP packet shall be forwarded towards its destination. All subsequent duplicate packets shall be discarded.

With the exception of TSS initialization messages, all packets that traverse the tunnels are TSS data messages, and they shall conform to the structure described in [Chapter 24](#).

#### 28.5.4 Tunnel Selection

When there are multiple potential RF links (e.g., routes) to a single receiving entity, the RF link management shall route all IP traffic to the target network through the appropriate tunnel. The appropriate tunnel is defined as the tunnel whose endpoint is associated with the transmitting entity that is actively being scheduled with TxOps for the target network.

 <b>NOTE</b>	During handoff scenarios, it is expected that RF link management will manage the tunnel selection in conjunction with the TxOp scheduling of the transmitting entities.
---	---

## Appendix 28-A

### Documentation of TunTap Device Driver for Linux

 <b>NOTE</b>	This appendix was written and published by somebody not affiliated with the RCC; therefore, it is edited only for formatting and not for content.
---	---

Universal TUN/TAP device driver.

Copyright (C) 1999-2000 Maxim Krasnyansky <max\_mk@yahoo.com>

Linux, Solaris drivers

Copyright (C) 1999-2000 Maxim Krasnyansky <max\_mk@yahoo.com>

FreeBSD TAP driver

Copyright (c) 1999-2000 Maksim Yevmenkin <m\_evmenkin@yahoo.com>

Revision of this document 2002 by Florian Thiel <florian.thiel@gmx.net>

#### 1. Description

TUN/TAP provides packet reception and transmission for user space programs. It can be seen as a simple Point-to-Point or Ethernet device, which, instead of receiving packets from physical media, receives them from user space program and instead of sending packets via physical media writes them to the user space program.

In order to use the driver a program has to open `/dev/net/tun` and issue a corresponding `ioctl()` to register a network device with the kernel. A network device will appear as `tunXX` or `tapXX`, depending on the options chosen. When the program closes the file descriptor, the network device and all corresponding routes will disappear.

Depending on the type of device chosen the userspace program has to read/write IP packets (with `tun`) or ethernet frames (with `tap`). Which one is being used depends on the flags given with the `ioctl()`.

The package from <http://vtun.sourceforge.net/tun> contains two simple examples for how to use `tun` and `tap` devices. Both programs work like a bridge between two network interfaces.

`br_select.c` - bridge based on `select` system call.

`br_sigio.c` - bridge based on `async io` and `SIGIO` signal.

However, the best example is VTun <http://vtun.sourceforge.net> :))

#### 2. Configuration

Create device node:

```
mkdir /dev/net (if it doesn't exist already)
```

```
mknod /dev/net/tun c 10 200
```

Set permissions:

e.g., `chmod 0666 /dev/net/tun`

There's no harm in allowing the device to be accessible by non-root users, since `CAP_NET_ADMIN` is required for creating network devices or for connecting to network devices that aren't owned by the user in question. If you want to create persistent devices and give ownership of them to unprivileged users, then you need the `/dev/net/tun` device to be usable by those users.

Driver module autoloading

Make sure that "Kernel module loader" - module auto-loading support is enabled in your kernel. The kernel should load it on first access.

Manual loading

insert the module by hand:

```
modprobe tun
```

If you do it the latter way, you have to load the module every time you need it, if you do it the other way it will be automatically loaded when `/dev/net/tun` is being opened.

### 3. Program interface

#### 3.1 Network device allocation:

`char *dev` should be the name of the device with a format string (e.g., `"tun%d"`), but (as far as I can see) this can be any valid network device name. Note that the character pointer becomes overwritten with the real device name (e.g., `"tun0"`)

```
#include <linux/if.h>
#include <linux/if_tun.h>

int tun_alloc(char *dev)
{
    struct ifreq ifr;
    int fd, err;

    if( (fd = open("/dev/net/tun", O_RDWR)) < 0 )
        return tun_alloc_old(dev);

    memset(&ifr, 0, sizeof(ifr));

    /* Flags: IFF_TUN   - TUN device (no Ethernet headers)
     *        IFF_TAP   - TAP device
     *
     *        IFF_NO_PI - Do not provide packet information
     */
    ifr.ifr_flags = IFF_TUN;
    if( *dev )
        strncpy(ifr.ifr_name, dev, IFNAMSIZ);
```

```

    if( (err = ioctl(fd, TUNSETIFF, (void *) &ifr)) < 0 ){
        close(fd);
        return err;
    }
    strcpy(dev, ifr.ifr_name);
    return fd;
}

```

### 3.2 Frame format:

If flag IFF\_NO\_PI is not set each frame format is:

- Flags [2 bytes]
- Proto [2 bytes]
- Raw protocol(IP, IPv6, etc) frame.

### 3.3 Multiqueue tuntap interface:

From version 3.8, Linux supports multiqueue tuntap, which can use multiple file descriptors (queues) to parallelize packets sending or receiving. The device allocation is the same as before, and if user wants to create multiple queues, TUNSETIFF with the same device name must be called many times with IFF\_MULTI\_QUEUE flag.

char \*dev should be the name of the device, queues is the number of queues to be created, fds is used to store and return the file descriptors (queues) created to the caller. Each file descriptor were served as the interface of a queue that could be accessed by userspace.

```

#include <linux/if.h>
#include <linux/if_tun.h>

int tun_alloc_mq(char *dev, int queues, int *fds)
{
    struct ifreq ifr;
    int fd, err, i;

    if (!dev)
        return -1;

    memset(&ifr, 0, sizeof(ifr));
    /* Flags: IFF_TUN   - TUN device (no Ethernet headers)
     *        IFF_TAP   - TAP device
     *
     *        IFF_NO_PI - Do not provide packet information
     *        IFF_MULTI_QUEUE - Create a queue of multiqueue device
     */
    ifr.ifr_flags = IFF_TAP | IFF_NO_PI | IFF_MULTI_QUEUE;
    strcpy(ifr.ifr_name, dev);

    for (i = 0; i < queues; i++) {
        if ((fd = open("/dev/net/tun", O_RDWR)) < 0)
            goto err;
        err = ioctl(fd, TUNSETIFF, (void *)&ifr);
    }
}

```

```

        if (err) {
            close(fd);
            goto err;
        }
        fds[i] = fd;
    }

    return 0;
err:
    for (--i; i >= 0; i--)
        close(fds[i]);
    return err;
}

```

A new `ioctl(TUNSETQUEUE)` were introduced to enable or disable a queue. When calling it with `IFF_DETACH_QUEUE` flag, the queue were disabled. And when calling it with `IFF_ATTACH_QUEUE` flag, the queue were enabled. The queue were enabled by default after it was created through `TUNSETIFF`.

`fd` is the file descriptor (queue) that we want to enable or disable, when `enable` is true we enable it, otherwise we disable it

```

#include <linux/if.h>
#include <linux/if_tun.h>

int tun_set_queue(int fd, int enable)
{
    struct ifreq ifr;

    memset(&ifr, 0, sizeof(ifr));

    if (enable)
        ifr.ifr_flags = IFF_ATTACH_QUEUE;
    else
        ifr.ifr_flags = IFF_DETACH_QUEUE;

    return ioctl(fd, TUNSETQUEUE, (void *)&ifr);
}

```

Universal TUN/TAP device driver Frequently Asked Question.

1. What platforms are supported by TUN/TAP driver?

Currently driver has been written for 3 Unices:

Linux kernels 2.2.x, 2.4.x

FreeBSD 3.x, 4.x, 5.x

Solaris 2.6, 7.0, 8.0

2. What is TUN/TAP driver used for?

As mentioned above, main purpose of TUN/TAP driver is tunneling. It is used by VTun (<http://vtun.sourceforge.net>).

Another interesting application using TUN/TAP is pipsecd (<http://perso.enst.fr/~beyssac/pipsec/>), a userspace IPsec implementation that can use complete kernel routing (unlike FreeS/WAN).

3. How does Virtual network device actually work?

Virtual network device can be viewed as a simple Point-to-Point or Ethernet device, which instead of receiving packets from a physical media, receives them from user space program and instead of sending packets via physical media sends them to the user space program.

Let's say that you configured IPX on the tap0, then whenever the kernel sends an IPX packet to tap0, it is passed to the application (VTun for example). The application encrypts, compresses and sends it to the other side over TCP or UDP. The application on the other side decompresses and decrypts the data received and writes the packet to the TAP device, the kernel handles the packet like it came from real physical device.

4. What is the difference between TUN driver and TAP driver?

TUN works with IP frames. TAP works with Ethernet frames.

This means that you have to read/write IP packets when you are using tun and ethernet frames when using tap.

5. What is the difference between BPF and TUN/TAP driver?

BPF is an advanced packet filter. It can be attached to existing network interface. It does not provide a virtual network interface. A TUN/TAP driver does provide a virtual network interface and it is possible to attach BPF to this interface.

6. Does TAP driver support kernel Ethernet bridging?

Yes. Linux and FreeBSD drivers support Ethernet bridging.

This page intentionally left blank.



## Appendix 28-B

### Documentation of TunTap Project for macOS

 <b>NOTE</b>	This appendix was written and published by somebody not affiliated with the RCC; therefore, it is edited only for formatting and not for content.
---	---

#### Overview

##### What is it?

The TunTap project provides kernel extensions for Mac OS X that allow to create virtual network interfaces. From the operating system kernel's point of view, these interfaces behave similar to physical network adapters such as an Ethernet network interface. However, the virtual interface does not send the packets into a wire, but makes them available to programs running in the system.

The software comes as a pair of kernel extensions that create virtual network interfaces on the IP and Ethernet level, respectively. These kind of network interfaces are commonly referred to as tun and tap devices on Unix-like platforms. This way of interfacing with the operating system's network stack is available on many platforms (cf. the [TUN/TAP](http://en.wikipedia.org/wiki/TUN/TAP) wikipedia article).

##### Who needs it?

By design, virtual network interfaces can be very flexibly used by any program that wants to receive packets from and inject them into the network stack. Generally, tun and tap devices are most commonly used in two distinct application scenarios: The first one is VPN software (such as [OpenVPN](http://openvpn.net)). In this scenario, the kernel sends its network packets to the tun or tap devices. The VPN software will then encrypt and forward them to the other side of the VPN tunnel where they get decrypted and delivered to their destination. The second area in which tun and tap devices are popular are system virtualization/emulation packages. In this case, the virtualized operating system instance talks to a fake network device (commonly a virtual Ethernet adapter). The virtualization software then creates a tap device and interconnects the two such that the host system can talk to the guest and vice versa.

##### How does it work?

The TunTap package is comprised of a pair of kernel extensions, one providing tun and one providing tap interfaces. They create a set of character devices `/dev/tunX` and `/dev/tapX`, respectively, where X is a number between zero and the maximum number of supported virtual interfaces. Once an application opens the character device, say `/dev/tap0`, a virtual network interface is created in the system, which will be named accordingly, i.e., `tap0`. The network interface can be assigned addresses just like any other network interfaces. After configuring the interface, packets that the kernel sends through this interface (as determined

by the routing table) can be read one packet at a time from the character device. Likewise, packets written to the character device will be injected into the kernel's network stack. For tun interfaces, the packets that are read and written are IP packets. For tap interfaces, the packet format is Ethernet frames.

#### Mailing list

There is a mailing list available through the Sourceforge project that is meant for general discussion about the TunTap software, asking questions, reporting bugs etc. It is called tuntaposx-users. If you are interested, you can register (<https://lists.sourceforge.net/lists/listinfo/tuntaposx-users>) or have a look at the archives ([http://sourceforge.net/mailarchive/forum.php?forum\\_name=tuntaposx-users](http://sourceforge.net/mailarchive/forum.php?forum_name=tuntaposx-users)).

#### Donations

So far, I have spent my spare time to run this project. If you want to show your gratitude or support further maintenance or development of the software, you can donate either via the Sourceforge donation system or directly to me via PayPal, just click the appropriate button below. In either case, your money enables me to buy copies of upcoming Mac OS X releases as well as development machines. A huge thank you goes to the nice people at mozilla.com who have given me the Mac Mini I currently use as development machine.

## Appendix 28-C

### Citations

Internet Engineering Task Force. “Definition of the Differentiated Services Field (DS Field) in the IPv4 and IPv6 Headers.” RFC 2474. Updated by RFC 8436, RFC 3260, and RFC 3168. December 1998. Retrieved 17 May 2021. Available at <https://datatracker.ietf.org/doc/rfc2474/>.

———. “Internet Protocol.” RFC 791. Updated by RFC 2474, RFC 6864, and RFC 1349. September 1981. Retrieved 17 May 2021. Available at <https://datatracker.ietf.org/doc/rfc791/>.

**\*\*\*\* END OF CHAPTER 28 \*\*\*\***

## ANNEX A-1

### Pulse Amplitude Modulation Standards

Acronyms .....	A.1-iii
Annex A.1. Pulse Amplitude Modulation Standards .....	A.1.1
1. General.....	A.1.1
2. Frame and Pulse Structure .....	A.1.1
2.1. Commutation Pattern .....	A.1.2
2.2. In-Flight Calibration .....	A.1.2
2.3. Frame Synchronization Interval.....	A.1.2
2.4. Maximum Pulse Rate.....	A.1.3
3. Frame and Pulse Rate.....	A.1.3
3.1. Long-Term Accuracy and Stability .....	A.1.3
3.2. Short-Term Stability .....	A.1.3
3.3. Multiple and Submultiple Sampling Rates .....	A.1.4
4. Frequency Modulation .....	A.1.4
5. Premodulation Filtering .....	A.1.4

#### List of Figures

Figure A.1-1. 50 percent duty cycle PAM with amplitude synchronization.....	A.1.1
Figure A.1-2. 100 percent duty cycle PAM with amplitude synchronization.....	A.1.2

This page intentionally left blank.

## Acronyms

dB	decibel
FM	frequency modulation
IF	intermediate frequency
PAM	pulse amplitude modulation
NRZ	non-return-to-zero
RZ	return-to-zero

This page intentionally left blank.



## ANNEX A.1

### Pulse Amplitude Modulation Standards

#### 1. General

This standard defines the recommended pulse train structure and design characteristics for the implementation of pulse amplitude modulation (PAM) telemetry systems. The PAM data is transmitted as time division multiplexed analog pulses with the amplitude of the information channel pulse being the analog-variable parameter.

#### 2. Frame and Pulse Structure

Each frame consists of a constant number of time-sequenced channel intervals. The maximum shall be 128-channel time intervals per frame, including the intervals devoted to synchronization and calibration. The pulse and frame structure shall conform to either [Figure A.1-1](#) or [Figure A.1-2](#).

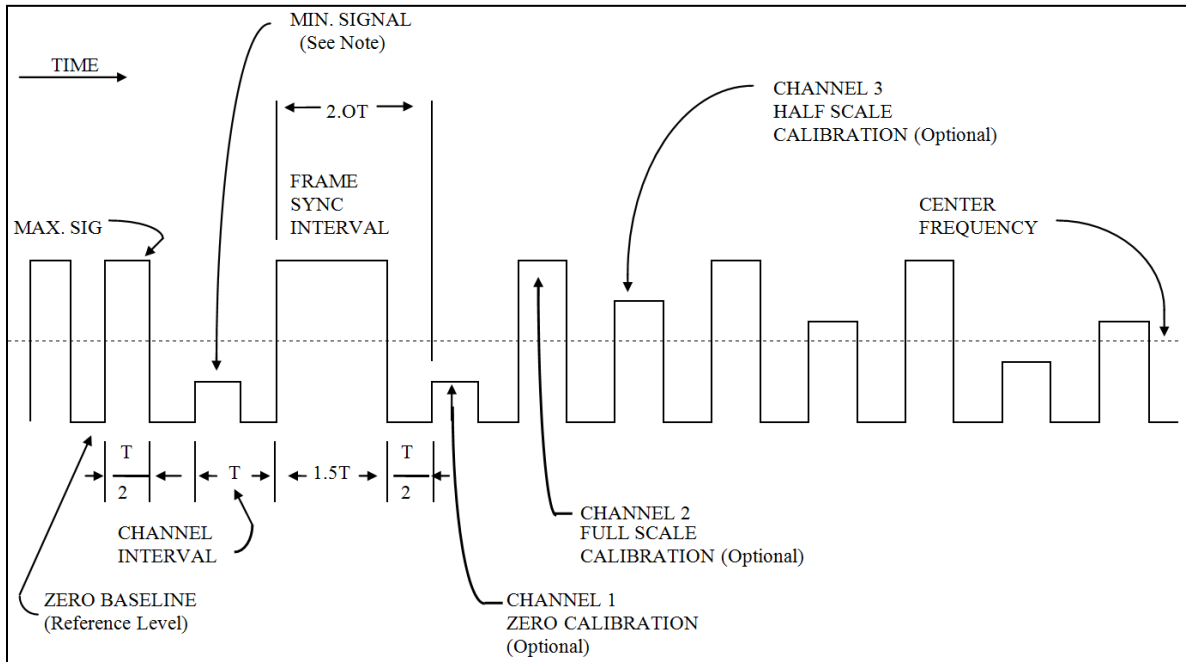



Figure A.1-1. 50 percent duty cycle PAM with amplitude synchronization

<p><b>NOTE</b></p> 	<p>A 20-25 percent deviation reserved for pulse synchronization is recommended.</p>
--	---

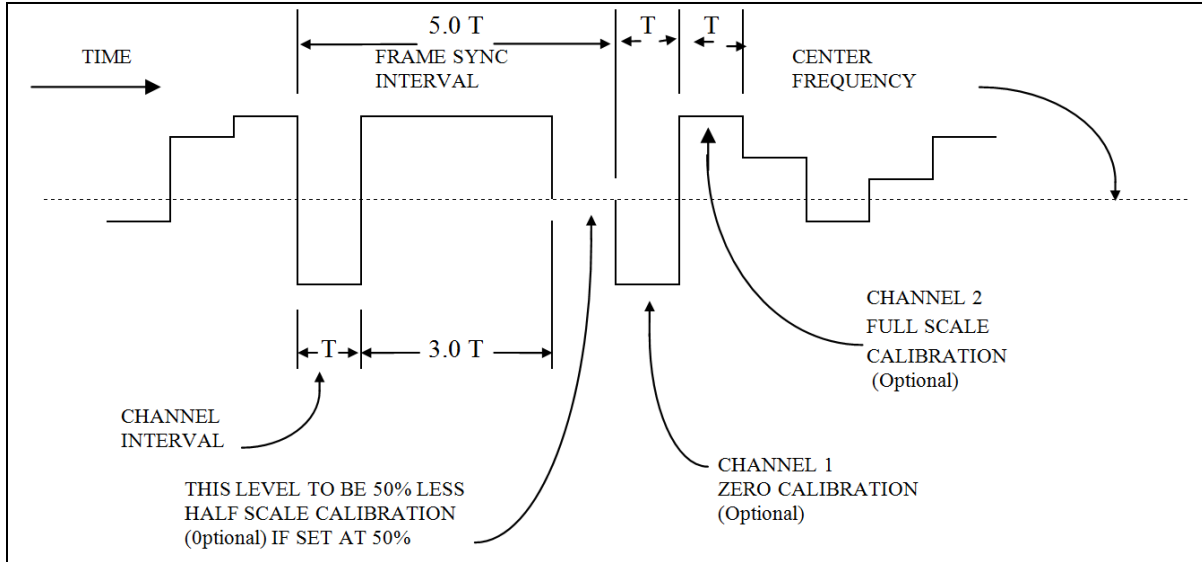

Figure A.1-2. 100 percent duty cycle PAM with amplitude synchronization

### 2.1. Commutation Pattern

The information channels are allocated equal and constant time intervals within the PAM frame. Each interval (“T” in [Figure A.1-1](#) and [Figure A.1-2](#)) contains a sample pulse beginning at the start of the interval and having amplitude determined by the amplitude of the measurand of the corresponding information channel according to a fixed relationship (usually linear) between the minimum level (zero amplitude) and the maximum level (full-scale amplitude). For a 50-percent duty cycle (return-to-zero [RZ]-PAM), the zero level shall be 20 to 25 percent of the full amplitude level as shown in [Figure A.1-1](#). The pulse width shall be the same in all time intervals except for the intervals devoted to synchronization. The duration shall be either  $0.5T \pm 0.05$ , as shown in [Figure A.1-1](#), or  $T \pm 0.05$ , as shown in [Figure A.1-2](#).

### 2.2. In-Flight Calibration

It is recommended that in-flight calibration be used and channels 1 and 2, immediately following the frame synchronization interval, be used for zero and full-scale calibration. For RZ-PAM, channel 3 may be used for an optional half-scale calibration, and for non-return-to-zero (NRZ)-PAM, the channel interval preceding channel 1 may be used for half-scale calibration if set to 50 percent.

### 2.3. Frame Synchronization Interval

Each frame is identified by the presence within it of a synchronization interval.

#### 2.3.1. Fifty Percent Duty Cycle (RZ-PAM)

The synchronization pattern interval shall have a duration equal to two information channel intervals ( $2T$ ) and shall be full-scale amplitude for  $1.5T$  followed by the reference level or zero baseline for  $0.5T$  (see [Figure A.1-1](#)).

2.3.2. **One Hundred Percent Duty Cycle (NRZ-PAM)**

The synchronization pattern is in the order given: zero level for a period of T, full-scale amplitude for a period of 3T, and a level not exceeding 50-percent full-scale amplitude for a period T (see [Figure A.1-2](#)).

2.4. **Maximum Pulse Rate**

The maximum pulse rate should not be greater than that permitted by the following subparagraphs.

2.4.1. **PAM/FM/FM**

The reciprocal of the shortest interval between transitions in the PAM pulse train shall not be greater than one-fifth of the total (peak-to-peak) deviation specified in [Chapter 3](#) (Table 3-1, Table 3-2, and Table 3-3) for the FM subcarrier selected.

2.4.2. **PAM/FM**

The reciprocal of the shortest interval between transitions in the PAM pulse train shall be limited by whichever is the narrower of the following:

- a. One-half of the 3-dB frequency of the premodulation filter when employed.
- b. One-fifth of the intermediate frequency (IF) bandwidth (3 dB points) selected from the IF bandwidths listed in [Chapter 2](#), Table 2-7.

**3. Frame and Pulse Rate**

The frame and pulse parameters listed below may be used in any combination:

- a minimum rate of 0.125 frames per second, and
- a maximum pulse rate as specified in subparagraphs [2.4.1](#) and [2.4.2](#) above.

3.1. **Long-Term Accuracy and Stability**

During a measured period of desired data, the time between the occurrences of corresponding points in any two successive frame synchronization intervals should not differ from the reciprocal of the specified nominal frame rate by more than 5 percent of the nominal period.

3.2. **Short-Term Stability**

During a measured period (P), containing 1000-channel intervals, the time between the start of any two successive channel intervals (synchronization intervals excepted) should not differ from the average channel interval established by the formula

$$T_{avg} = \frac{P}{1000}$$

by more than 1 percent of the average interval.

### 3.3. Multiple and Submultiple Sampling Rates

Data multiplexing at sampling rates which are multiples and submultiples of the frame rate is permissible.

#### 3.3.1. Submultiple Frame Synchronization

The beginning of the longest submultiple frame interval is identified by the transmission of a synchronization pattern. All other submultiple frames have a fixed and known relationship to the identified submultiple frames.

##### 3.3.1.1. *Fifty Percent Duty Cycle (RZ)*

The synchronization pattern has a full-scale amplitude pulse in two successive occurrences of channel intervals allocated to data channels of the identified submultiple frame. The first such pulse has a duration equal to the channel interval; the second pulse immediately follows the first pulse and has a duration nominally one-half the channel interval. There is no return to zero between the two pulses.

##### 3.3.1.2. *One Hundred Percent Duty Cycle (NRZ)*

The synchronization pattern has information in five successive occurrences of a channel interval allocated to data channels of the identified submultiple frame. The amplitude of the data channels assigned for synchronization is shown in the following items.

- a. First occurrence - zero amplitude.
- b. Second, third, and fourth occurrences - full-scale amplitude.
- c. Fifth occurrence - not more than 50 percent of full-scale amplitude.

#### 3.3.2. Maximum Submultiple Frame Length

The interval of any submultiple frame, including the time devoted to synchronizing information, shall not exceed 128 times the interval of the frame in which it occupies a recurring position.

## 4. **Frequency Modulation**

The frequency deviation of an FM carrier or subcarrier, which represents the maximum and minimum amplitude of a PAM waveform, should be equal and opposite with respect to the assigned carrier or subcarrier frequency. The deviation should be the same for all occurrences of the same level.

## 5. **Premodulation Filtering**

A maximally linear phase response, premodulation filter, is recommended to restrict the radiated spectrum (see [Chapter 2](#) Appendix 2-A).

\*\*\*\* **END OF ANNEX A.1** \*\*\*\*

## ANNEX A-2

### Magnetic Tape Recorder and Reproducer Information and Use Criteria

Acronyms .....	A.2-v
<b>Annex A.2. Magnetic Tape Recorder and Reproducer Information and Use Criteria.....</b>	<b>A.2-1</b>
<b>1. Other Instrumentation Magnetic Tape Recorder Standards .....</b>	<b>A.2-1</b>
<b>2. Double-Density Longitudinal Recording .....</b>	<b>A.2-1</b>
2.1. Other Track Configurations .....	A.2-2
2.2. High-Density Pulse Code Modulation Recording. ....	A.2-2
<b>3. Serial High-Density Digital Recording.....</b>	<b>A.2-6</b>
3.1. Some characteristics of the Bi $\phi$ -L code .....	A.2-6
3.2. Favorable characteristics of the RNRZ-L code .....	A.2-7
3.3. Unfavorable characteristics of the RNRZ-L code .....	A.2-7
3.4. Randomizer for RNRZ-L.....	A.2-8
<b>4. Head Parameters.....</b>	<b>A.2-12</b>
4.1. Gap Scatter .....	A.2-12
4.2. Head Polarity .....	A.2-13
<b>5. Record Level.....</b>	<b>A.2-13</b>
<b>6. Tape Crossplay Considerations .....</b>	<b>A.2-13</b>
<b>7. Standard Tape Signature Procedures.....</b>	<b>A.2-14</b>
7.1. PCM Signature Recording Procedure .....	A.2-14
7.2. PCM Signature Playback Procedure .....	A.2-15
7.3. Swept-Frequency Signature Recording Procedure .....	A.2-15
7.4. Swept-Frequency Signature Playback Procedure .....	A.2-15
<b>8. Equipment Required for Swept-Frequency Procedures.....</b>	<b>A.2-16</b>
<b>9. Fixed-Frequency Plus White Noise Procedure.....</b>	<b>A.2-16</b>
<b>10. Signature Playback and Analysis .....</b>	<b>A.2-17</b>
<b>11. Recording and Playback Alignment Procedures .....</b>	<b>A.2-18</b>
11.1. Recording of Preamble for Direct Electronics Alignment.....	A.2-18
11.2. Playback of Preamble for Direct Electronics Alignment.....	A.2-18
11.3. Recording of Preamble for FM Electronics Alignment.....	A.2-19
11.4. Playback of Preamble for FM Electronics Alignment.....	A.2-19
<b>12. General Considerations for Longitudinal Recording.....</b>	<b>A.2-20</b>
12.1. Tape Speeds .....	A.2-20
12.2. Tape Width.....	A.2-20

12.3.	Record and Reproduce Bandwidths.....	A.2-20
<b>13.</b>	<b>Recorded Tape Format.....</b>	<b>A.2-20</b>
13.1.	Track Width and Spacing.....	A.2-23
13.2.	Track Numbering.....	A.2-23
13.3.	Data Spacing.....	A.2-23
13.4.	Head Placement.....	A.2-24
<b>14.</b>	<b>Head and Head Segment Mechanical Parameters.....</b>	<b>A.2-27</b>
14.1.	Gap Scatter.....	A.2-27
14.2.	Head Segment Gap Azimuth Alignment.....	A.2-28
14.3.	Head Tilt.....	A.2-28
14.4.	Record-Head Segment Gap Parameters.....	A.2-28
<b>15.</b>	<b>Head Polarity.....</b>	<b>A.2-28</b>
15.1.	Record-Head Segment.....	A.2-28
15.2.	Reproduce-Head Segment.....	A.2-28
<b>16.</b>	<b>Magnetic Tape and Reel Characteristics.....</b>	<b>A.2-29</b>
16.1.	Tape Width.....	A.2-29
16.2.	Tape Guiding.....	A.2-29
<b>17.</b>	<b>Direct Record and Reproduce Systems.....</b>	<b>A.2-29</b>
17.1.	Direct Record Parameters.....	A.2-29
17.2.	Standard Record Level.....	A.2-30
17.3.	Reproduce Parameters.....	A.2-30
17.4.	Tape Speed and Flutter Compensation.....	A.2-30
<b>18.</b>	<b>Timing, Predetection, and Tape Signature Recording.....</b>	<b>A.2-31</b>
18.1.	Timing Signal Recording.....	A.2-31
18.2.	Predetection Recording.....	A.2-32
18.3.	Tape Signature Recording.....	A.2-32
<b>19.</b>	<b>FM Record Systems.....</b>	<b>A.2-32</b>
<b>20.</b>	<b>PCM Recording.....</b>	<b>A.2-34</b>
20.1.	Predetection PCM Recording.....	A.2-34
20.2.	Post-Detection PCM Recording.....	A.2-34
20.3.	Serial High-Density Digital Recording.....	A.2-35
20.4.	Direct Recording of PCM Telemetry Data.....	A.2-35
<b>21.</b>	<b>Preamble Recording for Automatic or Manual Recorder Alignment.....</b>	<b>A.2-38</b>
21.1.	Alignment, Direct Electronics.....	A.2-38
21.2.	Alignment, FM Electronics.....	A.2-38
<b>22.</b>	<b>Magnetic Tape Standards: General.....</b>	<b>A.2-38</b>
<b>23.</b>	<b>Definitions.....</b>	<b>A.2-40</b>
<b>24.</b>	<b>General Requirements for Standard Instrumentation Tapes and Reels.....</b>	<b>A.2-42</b>

24.1.	Reference Tape System.....	A.2-42
24.2.	Marking and Identifying .....	A.2-43
24.3.	Packaging.....	A.2-43
24.4.	Winding.....	A.2-43
24.5.	Reels and Hubs .....	A.2-43
24.6.	Radial Clearance (E-Value) .....	A.2-43
24.7.	Flammable Materials .....	A.2-43
24.8.	Toxic Compounds.....	A.2-43
<b>25.</b>	<b>General Characteristics of Instrumentation Tapes and Reels.....</b>	<b>A.2-43</b>
25.1.	Dimensional Specifications .....	A.2-44
25.2.	Environmental Conditions .....	A.2-44
25.3.	Other Characteristics.....	A.2-45
<b>26.</b>	<b>Physical Characteristics of Instrumentation Tapes and Reels .....</b>	<b>A.2-45</b>
<b>27.</b>	<b>Instrumentation Tape Magnetic and Electrical Characteristics .....</b>	<b>A.2-45</b>
27.1.	Bias Level .....	A.2-46
27.2.	Record Level.....	A.2-46
27.3.	Wavelength Response.....	A.2-46
27.4.	Output at 0.1 UBE Wavelength .....	A.2-46
27.5.	Short Wavelength Output Uniformity .....	A.2-47
27.6.	Dropouts.....	A.2-47
27.7.	Durability .....	A.2-48
27.8.	Modulation Noise.....	A.2-48
27.9.	Layer-to-Layer Signal Transfer .....	A.2-48
27.10.	Erase Ease.....	A.2-48
27.11.	Suggested Tape Requirement Limits .....	A.2-48
<b>Appendix A.</b>	<b>Citations.....</b>	<b>A.2-49</b>

### List of Figures

Figure A.2-1.	Record and reproduce head and head segment identification and location (7-track interlaced system).....	A.2-3
Figure A.2-2.	Randomizer block diagram.....	A.2-8
Figure A.2-3.	Randomized NRZ-L decoder block diagram.....	A.2-9
Figure A.2-4.	Random PCM power spectra .....	A.2-11
Figure A.2-5.	Bi $\phi$ -L at bit packing density of 15 kb/in.....	A.2-12
Figure A.2-6.	RNRZ-L at bit packing density of 25 kb/in .....	A.2-12
Figure A.2-7.	Tape Crossplay.....	A.2-14
Figure A.2-8.	Square wave responses .....	A.2-19
Figure A.2-9.	Recorded tape format.....	A.2-21
Figure A.2-10.	Head and head segment mechanical parameters.....	A.2-21
Figure A.2-11.	Record and reproduce head and head segment identification and location (N-track interlaced system).....	A.2-22
Figure A.2-12.	PCM record and reproduce configuration.....	A.2-23

Figure A.2-13. Serial high-density digital record and reproduce ..... A.2-36

**List of Tables**

Table A.2-1. Dimensions - Recorded Tape Format - 7 Tracks Interlaced on 12.7-mm (0.5 inch)-Wide Tape (Refer to Figure A.2-9)..... A.2-4

Table A.2-2. Dimensions - Recorded Tape Format - 14 Tracks Interlaced on 12.7-mm (0.5 inch) Wide Tape (Refer to Figure A.2-9)..... A.2-4

Table A.2-3. Dimensions - Recorded Tape Format - 42 Tracks Interlaced on 25.4-mm (1 inch) Wide Tape (Refer to Figure A.2-9)..... A.2-5

Table A.2-4. Record and Reproduce Parameters ..... A.2-24

Table A.2-5. Dimensions - Recorded Tape Format - 14 Tracks Interlaced on 25.4 mm (1 inch) Wide Tape<sup>(1)</sup> ..... A.2-25

Table A.2-6. Dimensions - Recorded Tape Format - 14 Tracks In-Line On 25.4 mm (1 inch) Wide Tape<sup>(1)</sup> ..... A.2-26

Table A.2-7. Dimensions - Recorded Tape Format - 14 Tracks Interlaced On 25.4 mm (1 inch) Wide Tape<sup>(1)</sup> ..... A.2-26

Table A.2-8. Upper Band Edge Maximum Level ..... A.2-29

Table A.2-9. Constant Amplitude Speed Control Signals<sup>(1)</sup> ..... A.2-31

Table A.2-10. Predetection Carrier Parameters ..... A.2-32

Table A.2-11. Wide-band and Double-Density FM Record Parameters ..... A.2-33

Table A.2-12. Maximum Recommended Bit Rates, Post-Detection Recording<sup>(1)</sup>..... A.2-34

Table A.2-13. Maximum Recommended Bit Rates ..... A.2-35

Table A.2-14. Suggested Tape Requirement Limits ..... A.2-38

Table A.2-15. Suggested Wavelength Response Requirements ..... A.2-39

Table A.2-16. Durability Signal Losses ..... A.2-39

Table A.2-17. Tape Dimensions ..... A.2-44

Table A.2-18. Environment Recommended Limits ..... A.2-44

Table A.2-19. Measurement Wavelengths..... A.2-46



## Acronyms

μm	micrometer
ANSI	American National Standards Institute
b/mm	bits per millimeter
Biφ	bi-phase
Biφ-L	bi-phase-level
dB	decibel
dc	direct current
FM	frequency modulation
ft	feet
HDD	High-Density Digital
HDDR	High-Density Digital Recording
HE	High-Energy
HR	High-Resolution
Hz	hertz
in	inch
in/s	inches per second
IRIG	Inter-Range Instrumentation Group
ISO	International Organization for Standardization
kA/m	kiloamps per meter
kb/in	kilobits per inch
kb/s	kilobits per second
kHz	kilohertz
Mb/s	megabits per second
MCT	manufacturer's centerline tape
MHz	megahertz
mm	millimeter
mm/s	millimeters per second
MSCT	manufacturer's secondary centerline tape
NRZ-L	non-return-to-zero level
PCM	pulse code modulation
RM	relative humidity
rms	root mean square
RNRZ-L	randomized non-return-to-zero level
SNR	signal-to-noise ratio
UBE	upper band edge
V	volt
Vdc	volts direct current
WRT	working reference tape

This page intentionally left blank.

## ANNEX A.2

### Magnetic Tape Recorder and Reproducer Information and Use Criteria

#### 1. Other Instrumentation Magnetic Tape Recorder Standards

The X3B6 Committee of the American National Standards Institute (ANSI) and the International Organization for Standardization (ISO) have prepared several standards for magnetic tape recording of instrumentation data. Documents may be obtained by contacting the ANSI web site (<http://webstore.ansi.org>).

Documentation applicable to this annex is identified in the following bullets.

- ISO 1860 (1986), Information Processing - Precision reels for magnetic tape used in interchange instrumentation applications.
- ISO 6068 (1985), Information Processing - Recording characteristics of instrumentation magnetic tape (including telemetry systems) - interchange requirements.
- ISO/IEC TR 6371:1989, Information Processing - Interchange practices and test methods for unrecorded instrumentation magnetic tape.
- ISO/IEC 8441/1:1991, Information technology - High Density Digital Recording (HDDR) - Part 1: Unrecorded magnetic tape for HDDR applications.
- ISO/IEC 8441/2:1991, Information technology - High Density Digital Recording (HDDR) - Part 2: Guide for interchange practice.
- ANSI INCITS 175-1999, 19 mm Type ID-1 Recorded Instrumentation - Digital Cassette Tape Format (formerly ANSI X3.175-1990).

#### 2. Double-Density Longitudinal Recording

Wide-band double-density analog recording standards allowing recording of up to 4 megahertz (MHz) signals at 3048 mm/s (120 in/s) are included in these standards. For interchange purposes, either narrow track widths 0.635 mm (25 mils) must be employed, or other special heads must be used. These requirements are necessary because of the difficulty in maintaining individual head-segment gap-azimuth alignment across a head close enough to keep each track's response within the  $\pm 2$ -dB variation allowed by the standards. Moreover, at the lower tape speeds employed in double-density recording, the 38-mm (1.5-in.) spacing employed in interlaced head assemblies result in interchannel time displacement variations between odd and even tracks that may be unacceptable for some applications. Therefore, it was decided that a 14-track in-line configuration on 25.4-mm (1-in.) tape should be adopted as a standard. This configuration results in essentially the same format as head number one of the 28-track interlaced configuration in the standards.

The 14-track interlaced heads are not compatible with tapes produced on an in-line standard configuration. If tapes must be interchanged, either a cross-configuration dubbing may be required or a change of head assemblies on the reproducing machine is necessary.

High energy magnetic tape is required for double-density systems. Such tapes are available but may require special testing for applications requiring a low number of dropouts per track.

#### 2.1. Other Track Configurations

The previously referenced standards in Section [1](#) include configurations resulting in 7, 14, and 21 tracks in addition to the 14-track and 28-track configurations listed in this annex. The high-density digital recording (HDDR) standards also reference an 84-track configuration on 50.8-mm (2-in.) tape. [Figure A.2-1](#) and [Table A.2-1](#) show the 7-track on 12.7-mm (0.5 in.) tape, [Table A.2-2](#) shows the 14-track on 12.7-mm (0.5 in.) tape, and [Table A.2-3](#) shows the 42-track on 25.4-mm (1 in.) tape configurations.

#### 2.2. High-Density Pulse Code Modulation Recording.

High-density digital recording systems are available from most instrumentation recorder manufacturers. Such systems will record at linear packing densities of 33,000 bits per inch or more per track. Special systems are available for error detection and correction with overhead penalties depending on the type and the sophistication of the system employed. The HDDR documents listed in Section [1](#) reference six different systems that have been produced; others are available.

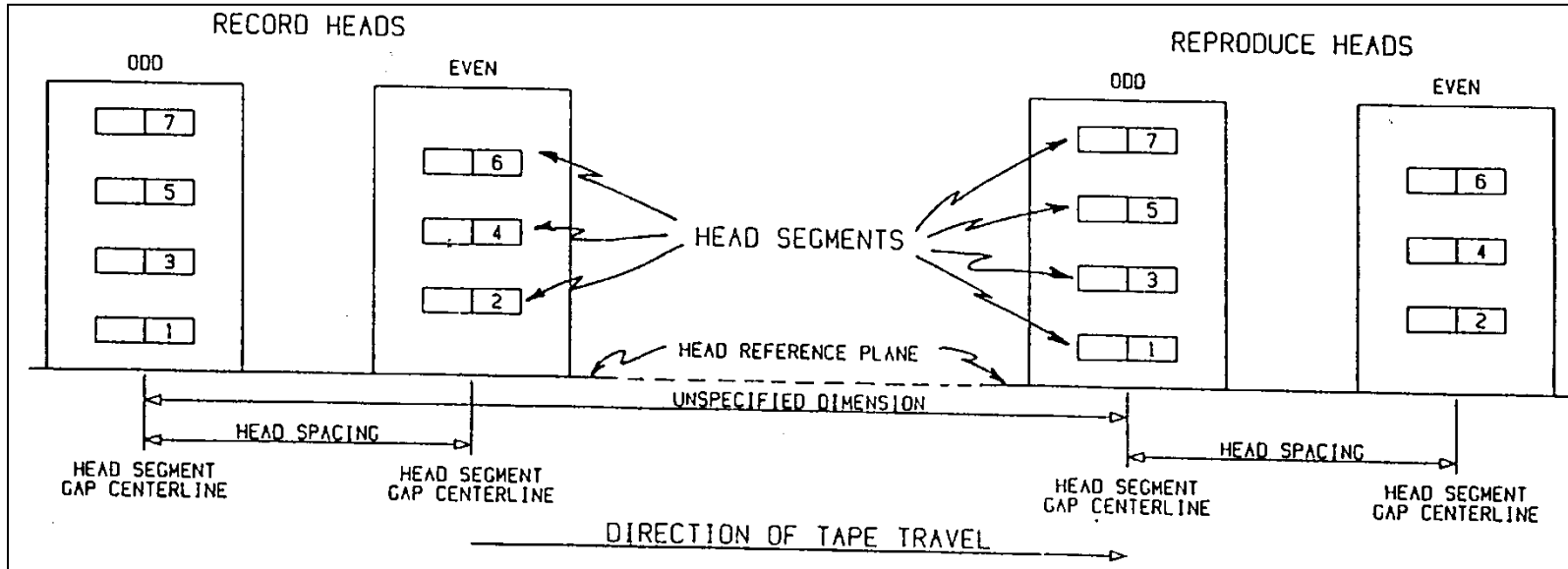

Figure A.2-1. Record and reproduce head and head segment identification and location (7-track interlaced system)

<b>Table A.2-1. Dimensions - Recorded Tape Format - 7 Tracks Interlaced on 12.7-mm (0.5 inch)-Wide Tape (Refer to <a href="#">Figure A.2-9</a>)</b>		
<b>Parameters</b>	<b>Millimeters</b>	<b>Inches</b>
Track Width	1.397 (Max); 1.143 (Min)	0.050±0.005
Track Spacing	1.778	0.070
Fixed Head Spacing	38.125 (Max); 38.075 (Min)	1.500±0.001
Adjustable Head Spacing	38.151 (Max); 38.049 (Min)	1.500±0.002
Edge Margin, Minimum	0.127	0.005
Reference Track Location	1.067 (Max); 0.965 (Min)	0.040±0.002
Track Location Tolerance	0.051 (Max); -0.051 (Min)	±0.002
<b>Location of n<sup>th</sup> Track</b>		
<b>Track Number</b>	<b>Millimeters</b>	<b>Inches</b>
1 (Reference)	0.000	0.000
2	1.829 (Max); 1.727 (Min)	0.070
3	3.607 (Max); 3.505 (Min)	0.140
4	5.385 (Max); 5.283 (Min)	0.210
5	7.163 (Max); 7.061 (Min)	0.280
6	8.941 (Max); 8.839 (Min)	0.350
7	10.719 (Max); 10.617 (Min)	0.420

<b>Table A.2-2. Dimensions - Recorded Tape Format - 14 Tracks Interlaced on 12.7-mm (0.5 inch) Wide Tape (Refer to <a href="#">Figure A.2-9</a>)</b>		
<b>Parameters</b>	<b>Millimeters</b>	<b>Inches</b>
Track Width	0.660 (Max); 0.610 (Min)	0.025±0.001
Track Spacing	0.889	0.035
Fixed Head Spacing	38.125 (Max); 38.075 (Min)	1.500±0.001
Adjustable Head Spacing	38.151 (Max); 38.049 (Min)	1.500±0.002
Edge Margin, Minimum	0.127	0.005
Reference Track Location	0.546 (Max); 0.470 (Min)	0.0200±0.001
Track Location Tolerance	0.038 (Max); -0.038 (Min)	±0.0015
<b>Location of n<sup>th</sup> Track</b>		
<b>Track Number</b>	<b>Millimeters</b>	<b>Inches</b>
1(Reference)	0.000	0.000
2	0.927 (Max); 0.851 (Min)	0.035
3	1.816 (Max); 1.740 (Min)	0.070
4	2.705 (Max); 2.629 (Min)	0.140
5	3.594 (Max); 3.518 (Min)	0.210
6	4.483 (Max); 4.407 (Min)	0.280
7	5.372 (Max); 5.292 (Min)	0.350
8	6.261 (Max); 6.185 (Min)	0.245
9	7.150 (Max); 7.074 (Min)	0.280
10	8.039 (Max); 7.963 (Min)	0.315

11	8.928 (Max); 8.852 (Min)	0.350
12	9.817 (Max); 9.741 (Min)	0.385
13	10.706 (Max); 10.630 (Min)	0.420
14	11.595 (Max); 11.519 (Min)	0.455

**Table A.2-3. Dimensions - Recorded Tape Format - 42 Tracks Interlaced on 25.4-mm (1 inch) Wide Tape (Refer to [Figure A.2-9](#))**

Parameters	Millimeters	Inches
Track Width	0.483 (Max); 0.432 (Min)	0.018±0.001
Track Spacing	0.584	0.023
Fixed Head Spacing	38.125 (Max); 38.075 (Min)	1.500±0.001
Adjustable Head Spacing	38.151 (Max); 38.049 (Min)	1.500±0.002
Edge Margin, Minimum	0.305	0.012
Reference Track Location	0.737 (Max); 0.660 (Min)	0.0275±0.015
Track Location Tolerance	0.025 (Max); -0.025 (Min)	±0.0000
Location of n <sup>th</sup> Track		
Track Number	Millimeters	Inches
1 (Reference)	0.000	0.000
2	0.610 (Max); 0.559 (Min)	0.023
3	1.194 (Max); 1.143 (Min)	0.046
4	1.778 (Max); 1.727 (Min)	0.069
5	2.362 (Max); 2.311 (Min)	0.092
6	2.946 (Max); 2.896 (Min)	0.115
7	3.531 (Max); 3.480 (Min)	0.138
8	4.115 (Max); 4.064 (Min)	0.161
9	4.699 (Max); 4.648 (Min)	0.184
10	5.283 (Max); 5.232 (Min)	0.207
11	5.867 (Max); 5.817 (Min)	0.230
12	6.452 (Max); 6.401 (Min)	0.253
13	7.036 (Max); 6.985 (Min)	0.276
14	7.620 (Max); 7.569 (Min)	0.299
15	8.204 (Max); 8.153 (Min)	0.322
16	8.788 (Max); 8.768 (Min)	0.345
17	9.373 (Max); 9.322 (Min)	0.368
18	9.957 (Max); 9.906 (Min)	0.397
19	10.541 (Max); 10.490 (Min)	0.414
20	11.125 (Max); 11.074 (Min)	0.437
21	11.709 (Max); 11.659 (Min)	0.460
22	12.294 (Max); 12.243 (Min)	0.483
23	12.878 (Max); 12.827 (Min)	0.506
24	13.462 (Max); 13.411 (Min)	0.529
25	14.046 (Max); 13.995 (Min)	0.552
26	14.630 (Max); 14.580 (Min)	0.575

27	15.215 (Max); 15.164 (Min)	0.598
28	15.799 (Max); 15.748 (Min)	0.621
29	16.383 (Max); 16.332 (Min)	0.664
30	16.967 (Max); 16.916 (Min)	0.667
31	17.551 (Max); 17.501 (Min)	0.690
32	18.136 (Max); 18.085 (Min)	0.713
33	18.720 (Max); 18.660 (Min)	0.736
34	19.304 (Max); 19.253 (Min)	0.759
35	19.888 (Max); 19.837 (Min)	0.782
36	20.472 (Max); 20.422 (Min)	0.805
37	21.057 (Max); 21.006 (Min)	0.828
38	21.641 (Max); 21.590 (Min)	0.851
39	22.225 (Max); 22.174 (Min)	0.874
40	22.809 (Max); 22.758 (Min)	0.897
41	23.393 (Max); 23.343 (Min)	0.920
42	23.978 (Max); 23.927 (Min)	0.943

### 3. Serial High-Density Digital Recording

The following paragraphs give some background for selecting the bi-phase ( $\text{Bi}\phi$ ) and randomized non-return-to-zero-level (RNRZ-L) systems specified in Subparagraph [20.3](#).

Serial HDDR is a method of recording digital data on a magnetic tape where the digital data is applied to one track of the recording system as a bi-level signal. The codes recommended for serial HDDR recording of telemetry data are  $\text{Bi}\phi$ -level ( $\text{Bi}\phi$ -L) and RNRZ-L (refer to Paragraph [20](#)).

In preparing Paragraph [20](#), the following codes were considered: Delay Modulation (Miller Code), Miller Squared, Enhanced NRZ, NRZ Level, NRZ Mark, and NRZ Space. These codes are not recommended for interchange applications at the bit rates given in Paragraph [20](#).

The properties of the  $\text{Bi}\phi$ -L and RNRZ-L codes relevant to serial HDDR and the methods for generating and decoding RNRZ-L are described next. Recording with bias is required for interchange applications because reproduce amplifier phase and amplitude equalization adjustments for tapes recorded without bias usually differ from those required for tapes recorded with bias.

The  $\text{Bi}\phi$ -L and RNRZ-L codes were selected for this standard because the “level” versions are easier to generate and are usually available as outputs from bit synchronizers. “Mark” and “Space” codes also have about twice as many errors as the level codes for the same signal-to-noise ratio (SNR). If polarity insensitivity is a major consideration, agreement between interchange parties should be obtained before these codes are used.

#### 3.1. Some characteristics of the $\text{Bi}\phi$ -L code

- a. Only a small proportion of the total signal energy occurs near direct current (dc).
- b. The maximum time between transitions is a 1-bit period.



- c. The symbols for one and zero are antipodal, meaning that the symbols are exact opposites of each other. Therefore, the bit error probability versus SNR performance is optimum.
- d. The Bi $\phi$ -L can be decoded using existing bit synchronizers.
- e. The Bi $\phi$ -L is less sensitive to maladjustments of bias and reproducer equalizers than most other codes.
- f. The Bi $\phi$ -L performs well at low tape speeds and low bit rates.

The most unfavorable characteristic of the Bi $\phi$ -L code is that it requires approximately twice the bandwidth of NRZ. Consequently, the maximum bit packing density that can be recorded on magnetic tape is relatively low.

### 3.2. Favorable characteristics of the RNRZ-L code

- a. The RNRZ-L requires approximately one-half the bandwidth of Bi $\phi$ -L.
- b. The symbols for one and zero are antipodal; therefore, the bit error probability versus SNR performance is optimum.
- c. The RNRZ-L decoder is self-synchronizing.
- d. The RNRZ-L data can be bit synchronized and signal conditioned using existing bit synchronizers with the input code selector set to NRZ-L.
- e. The RNRZ-L code is easily generated and decoded.
- f. The RNRZ-L data can be easily decoded in the reverse mode of tape playback.
- g. The RNRZ-L data are bit detected and decoded using a clock at the bit rate. Therefore, the phase margin is much larger than that of codes that require a clock at twice the bit rate for bit detection.
- h. The RNRZ-L code does not require overhead bits.

### 3.3. Unfavorable characteristics of the RNRZ-L code

- a. Long runs of bits without a transition are possible, although the probability of occurrence is low, and the maximum run length can be limited by providing transitions in each data word.
- b. Each isolated bit error that occurs after the data has been randomized causes three bit errors in the derandomized output data.
- c. The decoder requires 15 consecutive error-free bits to establish and reestablish error-free operation.
- d. The RNRZ-L bit stream can have large low frequency content. Consequently, reproducing data at tape speeds which produce pulse code modulation (PCM) bit rates less than 200 kilobits per second (kb/s) is not recommended unless a bit synchronizer with specially designed dc and low frequency restoration circuitry is available.

### 3.4. Randomizer for RNRZ-L

The randomizer is implemented with a network of shift registers and modulo-2 adders (exclusive-OR gates). The RNRZ-L bit stream is generated by adding (modulo-2) the reconstructed NRZ-L PCM data to the modulo-2 sum of the outputs of the 14th and 15th stages of a shift register. The output RNRZ-L stream is also the input to the shift register (see [Figure A.2-2](#)).

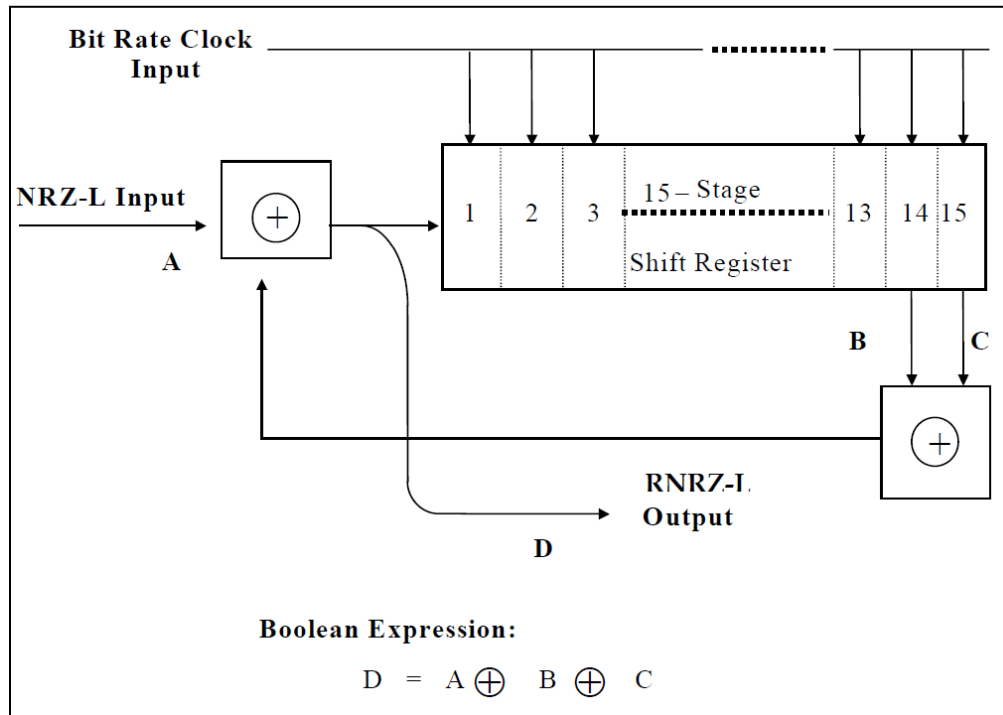

Figure A.2-2. Randomizer block diagram

The properties of an RNRZ-L bit stream are similar to the properties of a pseudo-random sequence. A 15-stage RNRZ-L encoder will generate a maximal length pseudo-random sequence of  $2^{15}-1$  (32,767) bits if the input data consists only of zeros and there is at least a single one in the shift register. A maximal length pseudo-random sequence is also generated when the input data consists only of ones and the shift register contains at least a single zero; however, if the shift register contains all zeros at the moment that the input bit stream is all zeros, the RNRZ-L output bit stream will also be all zeros. The converse is also true, meaning that when the shift register is filled with ones and the input bit stream is all ones, the RNRZ-L output bit stream will also be all ones. In these two cases, the contents of the shift register does not change and the output data is not randomized; however, the randomizer is not permanently locked-up in this state because a change in the input data will again produce a randomized output. In general, if the input bit stream contains runs of  $X$  bits without a transition with a probability of occurrence of  $p(X)$ , the output will contain runs having a length of up to  $(X+15)$  bits with a probability equal to  $(2^{-15} \cdot p(X))$ . Therefore, the output can contain long runs of bits without a transition, but the probability of occurrence is low.

The RNRZ-L bit stream is decoded (derandomized) by adding (modulo-2) the reconstructed RNRZ-L bit stream to the modulo-2 sum of the outputs of the 14th and 15th stages



Although the RNRZ-L decoder is self-synchronizing, 15 consecutive error-free bits must be loaded into the shift register before the output data will be valid. A bit slip will cause the decoder to lose synchronization, and 15 consecutive error-free data bits must again be loaded into the shift register before the output data is valid. The decoded output data, although correct, will contain the bit slip causing a shift in the data with respect to the frame synchronization pattern. Therefore, frame synchronization must be reacquired before the output provides meaningful data.

The RNRZ-L decoding system has an error multiplication factor of 3 for isolated bit errors (separated from adjacent bit errors by at least 15 bits). An isolated bit error introduced after randomization will produce 3 errors in the output data; the original bit in error, plus two additional errors 14 and 15 bits later. In addition, a burst of errors occurring after the data has been randomized will produce a burst of errors in the derandomized output. The number of errors in the output depends on the distribution of errors in the burst and can be greater than, equal to, or less than the number of errors in the input to the derandomizer; however, the derandomization process always increases the number of bits between the first and last error in the burst by 15. Errors introduced prior to randomization are not affected by either the randomizer or the derandomizer. The reverse decoder has the same bit error properties as the forward decoder.

Input data containing frequent long runs of bits without transitions creates potential dc and low frequency restoration problems in PCM bit synchronizers because of the low frequency cutoff of direct recorder and reproducer systems. The restoration problem can be minimized by reproducing the data at tape speeds that produce a bit rate for which the maximum time between transitions is less than 100 microseconds. Additional methods of minimizing these effects include selecting bit synchronizers containing special dc and low frequency restoration circuitry or recording data using Bi $\phi$ -L code.

The power spectra of the RNRZ-L and Bi $\phi$ -L codes are shown below in [Figure A.2-4](#). The power spectral density of RNRZ-L is concentrated at frequencies that are less than one-half the bit rate. The power spectral density of Bi $\phi$ -L is concentrated at frequencies in a region around 0.75 times the bit rate. The concentration of energy in the low-frequency region (when using the RNRZ-L code) has the effect of reducing the SNR as well as creating baseline wander, which the bit synchronizer must follow. Therefore, reproducing data at tape speeds which produce PCM bit rates of less than 200 kb/s is not recommended when using RNRZ-L unless a bit synchronizer with specially designed dc and low frequency restoration circuitry is available.

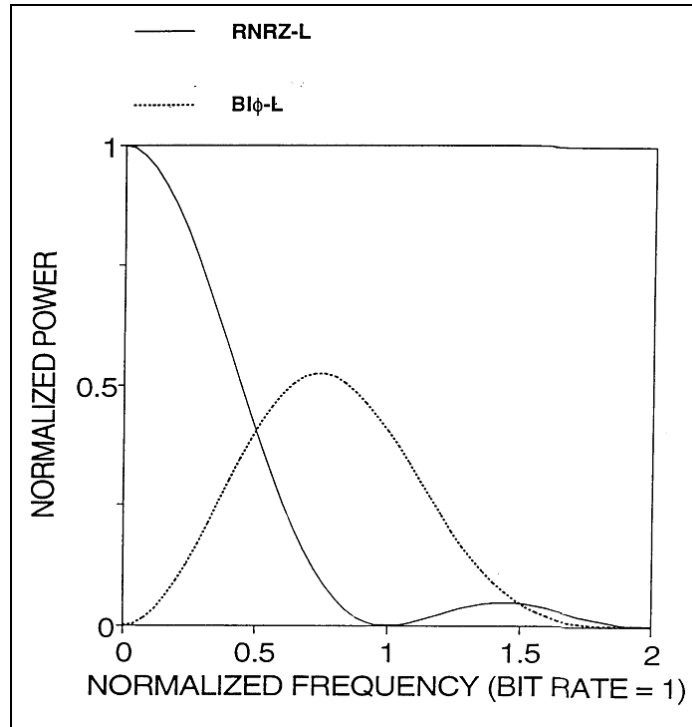

Figure A.2-4. Random PCM power spectra

Alignment of the reproducer system is very important to reproducing high quality PCM data (i.e. data with the lowest possible bit error probability). A PCM signature using the standard 2047-bit pseudo-random pattern, recorded on the leader or the trailer tape, provides a good method for reproducer alignment. When a pseudo-random bit error detection system is not available or when a PCM signature signal is not recorded, the recommended procedure for reproducer alignment involves the use of the eye pattern technique. The eye pattern is the result of superpositioning the zeros and ones in the PCM bit stream. The eye pattern is displayed on an oscilloscope by inserting the raw reproduced bit stream into the vertical input and the reconstructed bit-rate clock into the external synchronization input of the oscilloscope. The reproducer head azimuth, amplitude equalizers, and phase equalizers are then adjusted to produce the eye pattern with the maximum height and width opening.

Sample eye patterns are shown in [Figure A.2-5](#) and [Figure A.2-6](#). [Figure A.2-5](#) shows a Bi $\phi$ -L eye pattern at a recorded bit packing density of 15 kilobits per inch (kb/in) (450 kb/s at 30 inches per second [in/s]). [Figure A.2-6](#) shows an RNRZ-L eye pattern at a recorded bit packing density of 25 kb/in (750 kb/s at 30 in/s).

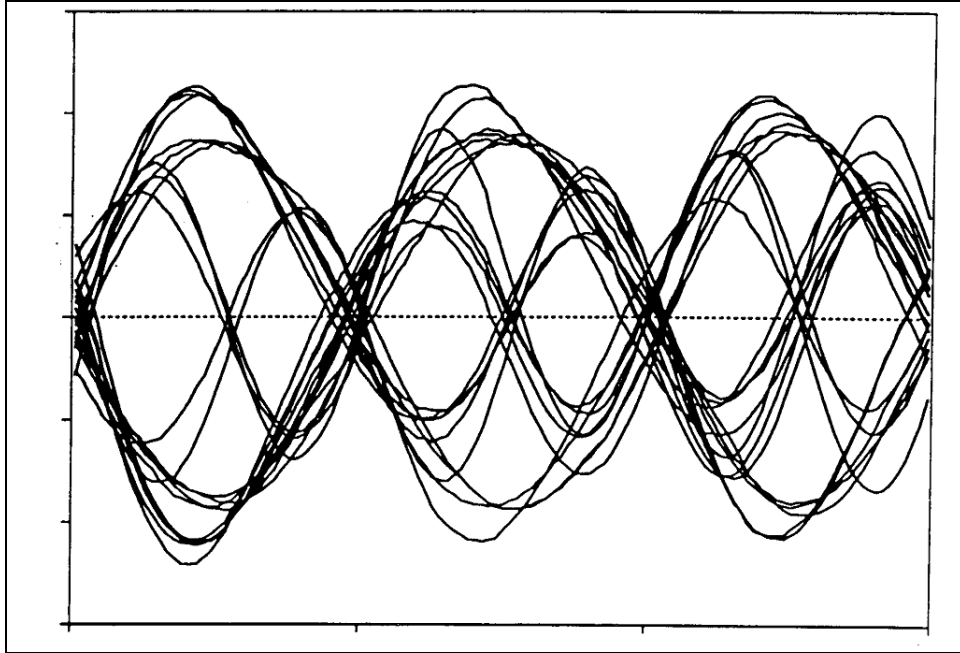

Figure A.2-5. Bi $\phi$ -L at bit packing density of 15 kb/in

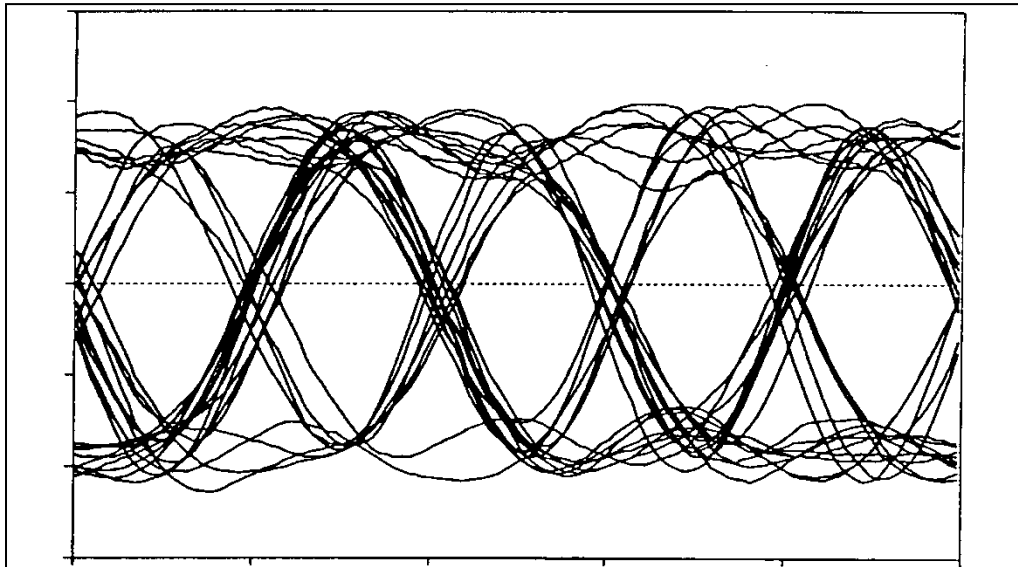

Figure A.2-6. RNRZ-L at bit packing density of 25 kb/in

#### 4. Head Parameters

The following describes the head parameters.

##### 4.1. Gap Scatter

Refer to the definitions in Section 6.2 of [106-11 Chapter 6](#). Gap scatter contains components of azimuth misalignment and deviations from the average line defining the azimuth. Since both components affect data simultaneity from record to reproduce, the gap scatter measurement is the inclusive distance containing the combined errors. Because azimuth

adjustment affects the output of wide-band systems, a 5.08- $\mu\text{m}$  (0.0002-in.) gap scatter is allowed for such recorders and reproducers. A 2.54- $\mu\text{m}$  (0.0001-in.) gap scatter is recommended for fixed-head systems (see [Figure A.2-11](#)).

#### 4.2. Head Polarity

The requirement that a positive pulse at a record amplifier input generate a south-north-north-south magnetic sequence and that a south-north-north-south magnetic sequence on tape produce a positive pulse at the reproduce amplifier output, still leaves two interdependent parameters unspecified. These parameters are (1) polarity inversion or non-inversion in record and playback amplifiers and (2) record or playback head winding sense. For the purpose of head replacement, it is necessary that these parameters be determined by the user so that an unsuspected polarity inversion, on tape or off tape, will not occur after heads are replaced.

### 5. **Record Level**

The standard record level is established as the input level of a sinusoidal signal set at the record level set frequency which, when recorded, produces a signal containing 1 percent third harmonic distortion at the output of a properly terminated reproduce amplifier (see Subparagraph 5.3.8.2 of Volume III, RCC Document 118<sup>1</sup>). A one percent harmonic distortion content is achieved when the level of the third harmonic component of the record level set frequency is  $40 \pm 1$  dB below the level of a sinusoidal signal of 0.3 upper band edge (UBE) which is recorded at the standard record level. Standard test and operating practice is to record and reproduce sinusoidal signals at 0.1 and 0.3 UBE and adjust the equalizers as necessary to establish the reproduced output at 0.3 UBE to within  $\pm 1.0$  dB of the output at 0.1 UBE. Then a 1-volt (V) root mean square (rms) signal at the record level set frequency is applied to the record amplifier input and the record and reproduce level controls are adjusted until the reproduced output contains 1 percent third harmonic distortion at a level of 1 V rms.

The optimum level for recording data will seldom be equal to the standard record level. Signals having noise-like spectral distribution such as baseband multiplexes of frequency modulation (FM) subcarriers contain high crest factors so that it may be necessary (as determined in Subparagraph 1.1, Volume IV, RCC Document 118<sup>2</sup>) to record at levels below the standard record level. On the other hand, for predetection and HDDR recording, signals may have to be recorded above the standard record level to give optimum performance in the data system.

### 6. **Tape Crossplay Considerations**

[Figure A.2-7](#) illustrates the typical departure from optimum frequency response that may result when crossplaying wide-band tapes that were recorded with heads employing different record-head gap lengths. Line AA is the idealized output-versus-frequency plot of a machine with record bias and record level, set upper IRIG standards, using a 3.05- $\mu\text{m}$  (120-microinch) record-head gap length and a 1.02- $\mu\text{m}$  (40-microinch) reproduce-head gap length. Lines BB and

<sup>1</sup> Range Commanders Council. *Test Methods for Recorder and Reproducer Systems and Magnetic Tape*. Volume III. RCC 118-99. May be superseded by update. Retrieved 17 May 2021. Available at <https://www.trmc.osd.mil/wiki/x/fou8Bg>.

<sup>2</sup> Range Commanders Council. *Test Methods for Telemetry Systems and Subsystems*. Volume IV. RCC 118-79. May be superseded by update. Retrieved 17 May 2021. Available at <https://www.trmc.osd.mil/wiki/x/gIu8Bg>.

CC represent the output response curves of the same tapes recorded on machines with 5.08- $\mu\text{m}$  (200-microinch) and 1.27- $\mu\text{m}$  (50-microinch) record-head gap lengths. Each of these recorders was set up individually per IRIG requirements. The tapes were then reproduced on the machine having a 1.02- $\mu\text{m}$  (40-microinch) reproduce-head gap length without readjusting its reproduce equalization.

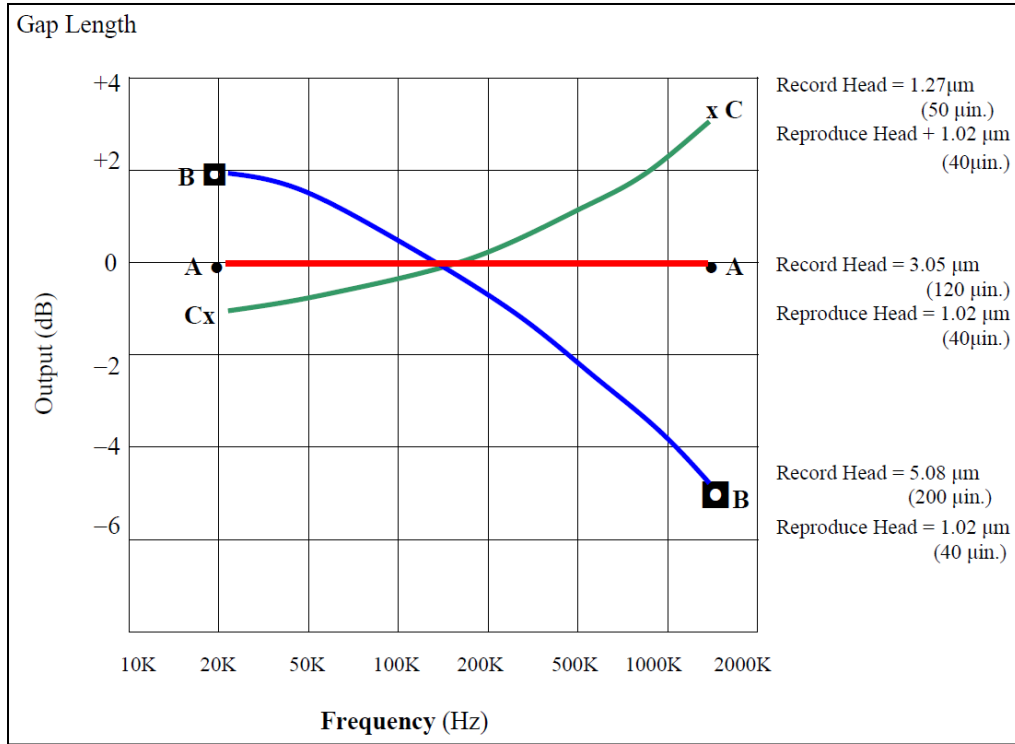

Figure A.2-7. Tape Crossplay

The output curves have been normalized to 0 dB at the 0.1 UBE frequency for the purpose of clarity. The normalized curves may be expected to exhibit a  $\pm 2.0$  dB variance in relative output over the passband. The tape recorded with the shortest head segment gap length will provide the greatest relative output at the UBE.

While the examples shown are from older equipment with record gap lengths outside the limits recommended in Subsection [13.4.4](#), they illustrate the importance of the record gap length in tape interchange applications.

## 7. Standard Tape Signature Procedures

The following describes the recording and playback procedures for the PCM signature and the swept-frequency signature.

### 7.1. PCM Signature Recording Procedure

Test equipment should be configured as described in Paragraph 2.1, Volume IV, RCC Document 118. The configuration should simulate the operational link as closely as possible to include the same radio frequency, deviation, bit rate, code type, predetection frequency, receiver bandwidth, and recorder speed. The following is the PCM signature recording procedure.



- a. While recording the pseudo-random data at standard record level, adjust the signal generator output level until approximately one error per  $10^5$  bits is obtained on the error counter.
- b. Record 30 seconds of the pseudo-random data at the beginning or end of the tape for each data track. A separate 30-second tape signature is recommended for each different data format.
- c. The content, track assignments, and location on the tape leader and trailer of signature signals should be noted on the tape label.

#### 7.2. PCM Signature Playback Procedure

The following steps explain the playback procedure.

- a. Optimize playback equipment such as receiver tuning and bit synchronizer setup for data being reproduced.
- b. Reproduce the tape signature and observe the error rate on the error counter.
- c. Optimize head azimuth for maximum signal output and minimum errors.
- d. Initiate corrective action if more than one error per  $10^4$  bits is obtained.
- e. Repeat for each data track.

#### 7.3. Swept-Frequency Signature Recording Procedure

The following steps describe the recording procedure for the swept-frequency signature.

- a. Patch a sweep-frequency oscillator output to all prime data tracks up to 6 on 7-track recorders or up to 13 on 14-track recorders. As a minimum, patch the sweep oscillator to one odd and one even track.
- b. Connect the sync output of the sweep oscillator to a track not used for sweep signals, preferably an outside track.
- c. Record the signature signals for a minimum of 30 seconds at standard record level.

 <b>NOTE</b>	Record levels may be either pre-adjusted or quickly adjusted in all tracks during the first few seconds of the signature recording.
---	---

- d. Note the content, track assignments, and location on the leader or trailer tape of signature signals on the tape label.

#### 7.4. Swept-Frequency Signature Playback Procedure

The following steps define the steps for the playback procedure.

- a. Connect the sync track output of the reproducer to the sync input of the scope.
- b. Select an odd-numbered sweep-signal track and connect the output of the reproducer to the vertical input of the scope. Playback the sweep signal and adjust the scope gain for an amplitude of approximately  $\pm 10$  minor vertical divisions about the center baseline. Adjust

the odd-track azimuth for maximum amplitude of the highest frequency segment (extreme right of the sweep pattern).

- c. Observe amplitude variations through the sweep pattern and adjust the equalization, if necessary, to maintain the amplitude within the required tolerance over the required frequency range.

	<p><b>NOTE</b> A decrease of sweep signal amplitude to about 0.7 represents a 3-dB loss.</p>
---	--

- d. Repeat the playback procedure in the previous two steps for azimuth and equalization adjustments of an even-numbered tape track.
- e. Repeat the procedure in step c for equalization only of other selected prime data tracks, as required.

## 8. Equipment Required for Swept-Frequency Procedures

Equipment required at the recording site consists of a sweep-frequency oscillator having a constant amplitude sweep range of approximately 400 hertz (Hz) through 4.4 MHz with frequency markers at 62.5, 125, 250, and 500 kilohertz (kHz) and 1.0, 2.0, and 4.0 MHz. The sweep range to 4.4 MHz may be used for all tape speeds because the bandwidth of the recorder and reproducer will attenuate those signal frequencies beyond its range. The sweep rate should be approximately 25 Hz. Care should be exercised in the installation of the sweep generator to ensure a flat response of the sweep signal at the input terminals of the recorder. Appropriate line-driver amplifiers may be required for long cable runs or the low impedance of paralleled inputs.

A stepped-frequency oscillator could be substituted for the sweep-frequency generator at the recording location. Recommended oscillator wavelengths at the mission tape speed are 7.62 mm (300 mils), 3.81 mm (150 mils), 0.254 mm (10 mils), 0.0254 mm (1 mil), 0.0127 mm (0.5 mil), 0.0064 mm (0.25 mil), 0.0032 mm (0.125 mil), 0.0025 mm (0.1 mil), 0.0020 mm (0.08 mil), and 0.0015 mm (0.06 mil).

Equipment required at the playback site consists of an ordinary oscilloscope having a flat frequency response from 400 Hz through 4.4 MHz.

## 9. Fixed-Frequency Plus White Noise Procedure

The signature used in this method is the same for all applications. For direct recording of subcarrier multiplexes, only static nonlinearity (nonlinearity which is independent of frequency) is important for crosstalk control. Subparagraph [17.2](#) provides a reference level for static nonlinearity. All formats of data recording are sensitive to SNR. Predetection recording and HDDR are sensitive to equalization. The following signature procedure satisfies all the above requirements.

- a. Record a sine-wave frequency of 0.1 UBE (see [Table A.2-6](#)) with the following amplitudes.
  - (1) Equal to the standard record level for direct recording of subcarrier multiplexes and HDDR (see Subparagraph [17.2](#)).

- (2) Equal to the carrier amplitude to be recorded for pre-detection recording of PCM/FM, PCM/PM, FM/FM, and pulse amplitude modulation/FM.
- b. Record flat band-limited white noise of amplitude 0.7 of the true rms value of the 0-dB standard record level as described in Subparagraph [17.2](#). Noise must be limited by a low-pass filter just above the UBE.
- c. Record with zero input (input terminated in 75 ohms). The three record steps previously described can consist of 10 seconds each. The spectra can be obtained with three manually initiated sweeps of less than a second each, because no great frequency resolution is required. All of the spectrum analyzer parameters can be standardized and set in (inputted) prior to running the mission tape.

## 10. Signature Playback and Analysis

Before analyzing the signature, the reproducer azimuth should be adjusted. With the short signature, it is probably more convenient to use the data part of the recording for this purpose. If predetection recording is used, the azimuth can be adjusted to maximize the output as observed on the spectrum analyzer or on a voltmeter connected to the output. If baseband recording is used, the azimuth can be adjusted to maximize the spectrum at the upper end of the band. A spectrum analyzer should be used to reproduce, store, and photograph the spectra obtained from steps a, b, and c in Section [9](#). The spectrum analyzer input level of zero should be stored and photographed.

It is evident that any maladjustment of the recorder and reproducer or magnetization of the heads will result in the decrease of SNR across the band and will be seen from the stored spectra or photograph.

By having a photograph of the spectra, amplitude equalization can be accomplished without shuttling the mission tape as follows.

- a. Use an auxiliary tape (not the mission tape, but preferably the same type tape). With a white-noise input signal band limited, adjust the amplitude equalization of the recorder and reproducer at the tape dubbing or data reduction site and photograph the output spectrum (see Section [9](#)).
- b. Compare this photo with the photo made from the signature. Note the difference at several points across the band.
- c. Using the auxiliary tape, adjust the amplitude equalization to compensate for the differences noted.
- d. Recheck with the mission tape to verify that the desired amplitude equalization has been achieved.

If the phase equalization is to be checked, a square wave signal can be added to the signature in accordance with the manufacturer's specification (see Volume III, RCC Document 118). The same procedure that is recommended for amplitude equalization can be used, except the procedure is based on oscillograms.

## 11. Recording and Playback Alignment Procedures

When using standard preamble (or postamble), see Section [21](#).

### 11.1. Recording of Preamble for Direct Electronics Alignment.

- a. Patch a square wave generator output set to 1/11 band edge to all tracks having direct electronics or initiate procedure for recording internally generated 1/11 band edge square wave according to manufacturer's instructions.
- b. If the preamble will be used for a manual adjustment, record for a minimum of 30 seconds at the standard record level and tape speed to be used for data recording.
- c. If the preamble will be used only for automatic alignment, record at the standard record level and tape speed to be used for data recording for a sufficient time as specified by the manufacturer of the playback recorder reproducer or as agreed by the interchange parties.

### 11.2. Playback of Preamble for Direct Electronics Alignment.

For systems so equipped, initiate automatic alignment procedure per manufacturer's instructions. The procedure for manual adjustment is described in the following steps.

- a. Display fundamental and odd harmonics of the square wave (third through eleventh) of selected odd numbered direct track near center of head stack on the spectrum analyzer. Adjust azimuth by peaking output amplitude of the third through eleventh harmonic. Final adjustment should peak the eleventh harmonic.
- b. Repeat step a for even numbered direct track. (Only one track is necessary for a double-density, 14-track, in-line system.)
- c. Observe frequency response across the band pass on selected track and correct if necessary. For a flat response, the third harmonic will be 1/3 of the amplitude of the fundamental, fifth harmonic 1/5 the amplitude, and so on. A convenient method is to compare the recorder/reproducer output with that of a square wave generator patched directly to the spectrum analyzer.

 <b>NOTE</b>	An alternate, but less accurate, method is to optimize the square wave as displayed on an oscilloscope rather than a spectrum analyzer.
---	---

- d. Repeat step c for each direct track.
- e. Display square wave on an oscilloscope. Adjust phase for best square wave response as shown in [Figure A.2-8](#).
- f. Repeat step e for each direct track.

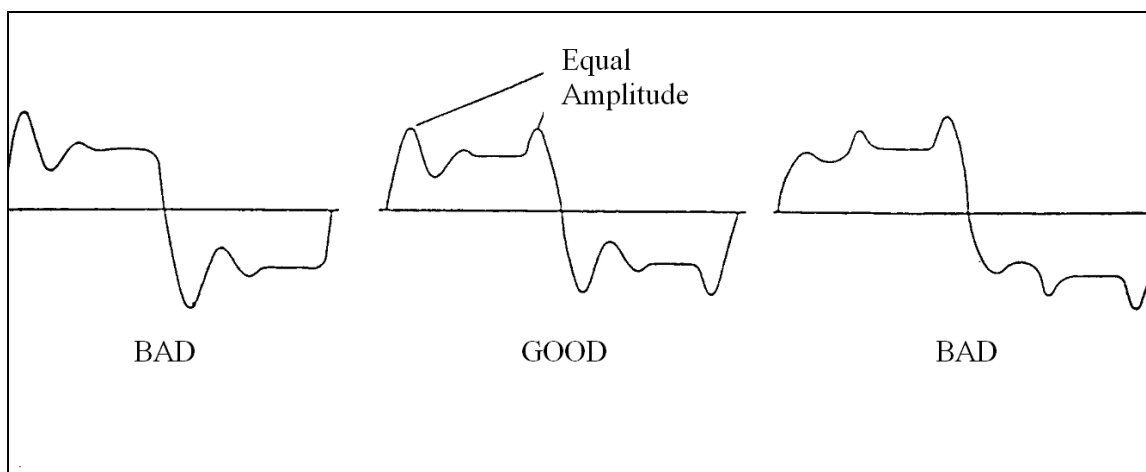

Figure A.2-8. Square wave responses

### 11.3. Recording of Preamble for FM Electronics Alignment

If available, initiate the procedure for recording internally generated 1/11 band edge square wave and  $\pm 1.414$  Vdc per manufacturer's instructions. Otherwise, patch a square wave generator output to all tracks having FM electronics. A near dc signal may be obtained by setting the square wave generator to 0.05 Hz and  $\pm 1.414$  V or by using a separate dc source.

- a. If the preamble will be used for manual alignment, record at least one cycle of the 0.05 Hz square wave at  $\pm 1.414$  V or a positive and negative 1.414 Vdc for a minimum of 10 seconds each at the tape speed to be used for data recording. Next, record a 1/11 band edge square wave for a minimum of 20 seconds.
- b. If the preamble will be used only for automatic alignment, record the above sequence for a sufficient time as specified by the manufacturer of the playback recorder/reproducer or as agreed by the interchange parties.

### 11.4. Playback of Preamble for FM Electronics Alignment

For systems so equipped, initiate automatic alignment procedure per manufacturer's instructions. The procedure for manual adjustment is described in the next steps.

- a. Check and adjust for 0-V output at center frequency per RCC Document 118, Test Methods for Telemetry Systems and Subsystems, Volume III, Test Methods for Recorder/Reproducer Systems and Magnetic Tape.
- b. Use dc voltmeter to verify a full positive and negative output voltage on the selected track and correct if necessary.
- c. Display fundamental and odd harmonics of the square wave (third through eleventh) on the spectrum analyzer.
- d. Observe frequency response per step c in Subsection [11.2](#).
- e. Repeat steps a through c for each FM track.

## 12. General Considerations for Longitudinal Recording

Standard recording techniques, tape speeds, and tape configurations are required to provide maximum interchange of recorded telemetry magnetic tapes between the test ranges. Any one of the following methods of information storage or any compatible combination may be used simultaneously: direct recording, predetection recording, FM recording, or PCM recording. Double-density recording may be used when the length of recording time is critical; however, it must be used realizing that performance parameters such as SNR, crosstalk, and dropouts may be degraded (see Section 2).

### 12.1. Tape Speeds

The standard tape speeds for instrumentation magnetic tape recorders are shown in [Table A.2-4](#).

### 12.2. Tape Width

The standard nominal tape width is 25.4 mm (1 in.) (see [Table A.2-17](#)).

### 12.3. Record and Reproduce Bandwidths

For the purpose of these standards, two system bandwidth classes are designated: wide band and double density (see [Table A.2-4](#)). Interchange of tapes between the bandwidth classes is NOT recommended.

## 13. Recorded Tape Format

The parameters related to recorded tape format and record and reproduce head configurations determine compatibility between systems that are vital to interchangeability (crossplay) of recorded magnetic tapes. Refer to the definitions in Section 6.2 of [106-11 Chapter 6](#), [Figure A.2-9](#), [Figure A.2-10](#), and [Figure A.2-11](#). Refer also to [Table A.2-5](#), [Table A.2-6](#), [Table A.2-7](#), and [Figure A.2-12](#).

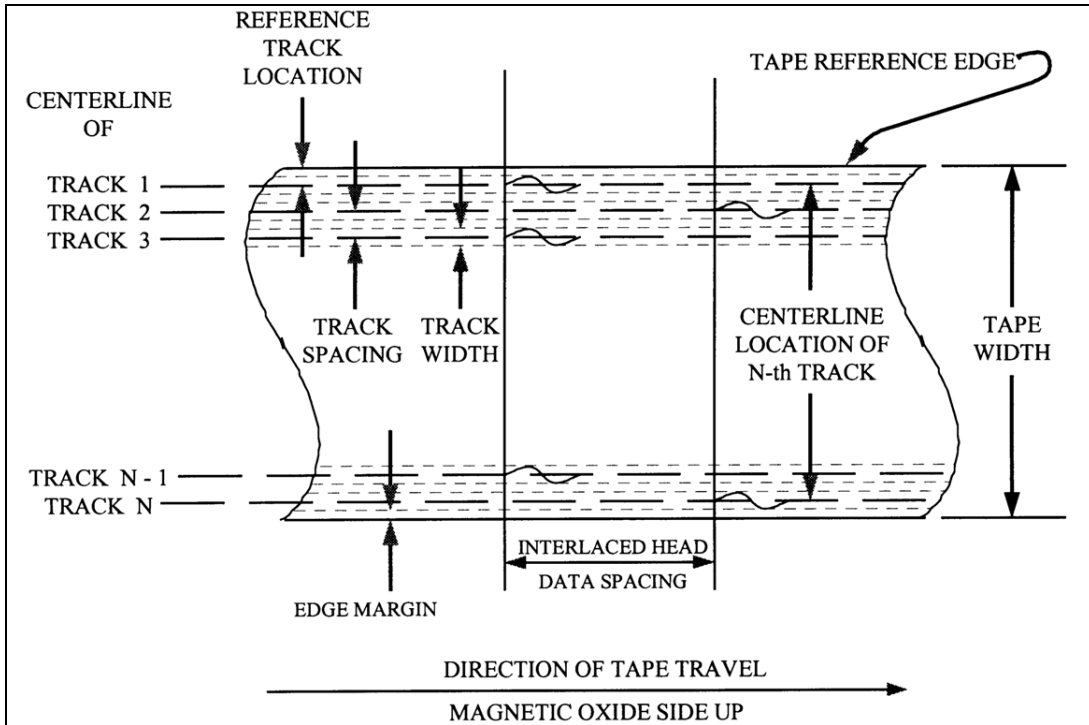

Figure A.2-9. Recorded tape format

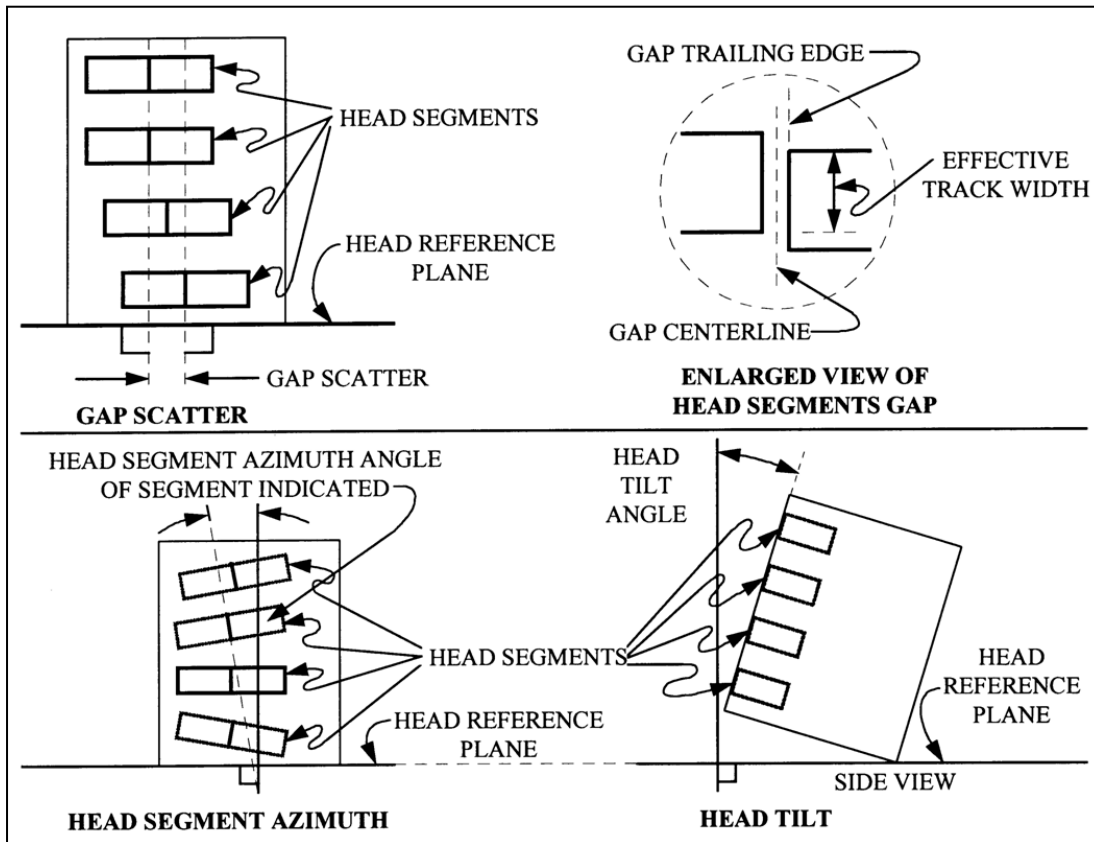

Figure A.2-10. Head and head segment mechanical parameters

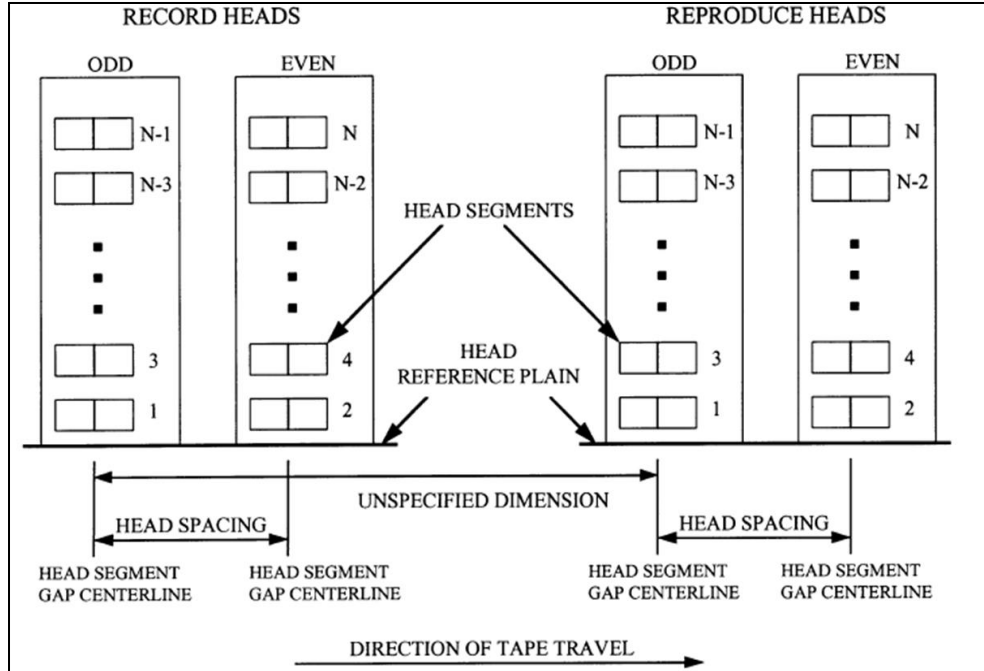

Figure A.2-11 Record and reproduce head and head segment identification and location (N-track interlaced system)



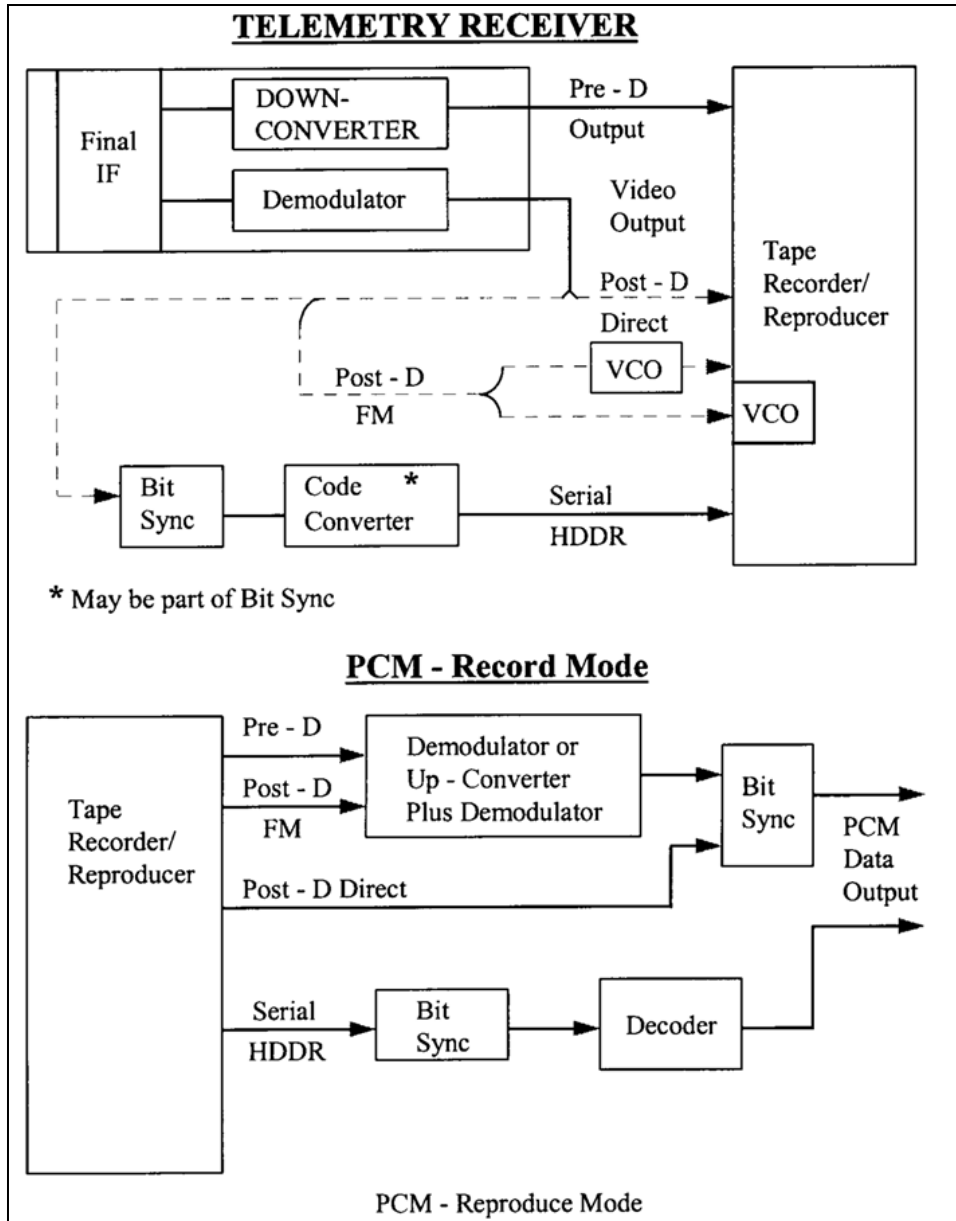

Figure A.2-12. PCM record and reproduce configuration

13.1. Track Width and Spacing

Refer to [Figure A.2-11](#), [Table A.2-5](#), [Table A.2-6](#), and [Table A.2-7](#).

13.2. Track Numbering

The tracks on a tape are numbered consecutively from track 1 through track n with track 1 located nearest the tape reference edge as shown in [Figure A.2-9](#).

13.3. Data Spacing

For interlaced formats, the spacing on tape between simultaneous events on odd and even tracks is nominally 38.1 mm (1.5 in). See Subparagraph [13.4.1](#).

### 13.4. Head Placement

The standard technique for wide band and 28-track double density is to interlace the heads, both the record and the reproduce, and to provide alternate tracks in separate heads. Thus, to record on all tracks of a standard width tape, two interlaced record heads are used. To reproduce all tracks of a standard width tape, two interlaced reproduce heads are used. For 14-track double density, the standard technique uses one in-line record head and one in-line reproduce head.

#### 13.4.1. Head Placement, Interlaced

Two heads comprise the record-head pair or the reproduce-head pair. Mounting of either head pair is done in such a manner that the center lines drawn through the head gaps are parallel and spaced 38.10 mm  $\pm$ 0.05 (1.500 in.  $\pm$ 0.002) apart, as shown in [Table A.2-5](#) and [Table A.2-7](#), for systems that include head azimuth adjustment. The dimension between gap centerlines includes the maximum azimuth adjustment required to meet system performance requirements. For systems with fixed heads (i.e., heads without an azimuth adjustment), the spacing between gap centerlines shall be 38.10 mm  $\pm$ 0.03 (1.500 in.  $\pm$ 0.001) (see [Figure A.2-10](#)).

#### 13.4.2. Head Identification and Location

A head segment is numbered to correspond to the track number that segment records or reproduces. Tracks 1, 3, 5, ... are referred to as the "odd" head segments. Tracks 2, 4, 6, ... are referred to as the even head segments. For interlaced heads, the head containing the odd numbered segments (odd head) is the first head in a pair of heads (record or reproduce) over which an element of tape passes when moving in the forward record or reproduce direction (see Figure 6-2 of [106-11 Chapter 6](#)).

#### 13.4.3. In-Line Head Placement

An in-line head shall occupy the position of head number 1 in an interlaced system.

#### 13.4.4. Head Segment Location

Any head segment within a head shall be located within  $\pm$ 0.05 mm ( $\pm$ 0.002 in.) of the nominal (dimension from table without tolerances) position required to match the track location as shown in [Figure A.2-11](#), [Table A.2-5](#), [Table A.2-6](#), and [Table A.2-7](#).

<b>Table A.2-4. Record and Reproduce Parameters</b>				
Tape Speed		$\pm$ 3 dB Reproduce Passband kHz <sup>(1)</sup>	Direct Record Bias Set Frequency (UBE) kHz <sup>(2)</sup>	Level Set Frequency 10% of UBE, kHz
mm/s	in/s			
Wide Band			Overbias 2dB	
6096.0	240	0.8-4000	4000	400
3048.0	120	0.4-2000	2000	200
1524.0	60	0.4-1000	1000	100
762.0	30	0.4-500	500	50
381.0	15	0.4-	250	25
190.5	7-1/2	0.4-5	125	12.5
95.2	3-3/4	0.4-2.5	62.5	6.25
47.6	1-7/8	0.4-31.25	31.25	3.12

Double Density			Overbias 2 dB	
3048.0	120	2-4000	4000	400
1524.0	60	2-2000	2000	200
762.0	30	2-1000	1000	100
381.0	15	2-500	500	50
190.0	7-1/2	1-250	250	25
95.2	3-3/4	0.5-125	125	12.5

Notes:

1. Passband response reference is the output amplitude of a sinusoidal signal at the record level set frequency recorded at standard record level. The record level set frequency is ten percent of the upper band edge frequency (0.1 UBE).
2. When setting record bias level, a UBE frequency input signal is employed. The signal input level is set 5 to 6 dB below standard record level to avoid saturation effects which could result in erroneous bias level settings. The record bias current is adjusted for maximum reproduce output level and then increased until the output level decreases by the number of dB indicated in the table (see Subparagraph 5.3.8.1 of Volume III, RCC Document 118).

<b>Table A.2-5. Dimensions - Recorded Tape Format - 14 Tracks Interlaced on 25.4 mm (1 inch) Wide Tape<sup>(1)</sup></b>		
<b>Parameters</b>	<b>Millimeters</b>	<b>Inches</b>
Track Width	1.397 (Min); 1.143 (Max)	0.050 ±0.005
Track Spacing	1.778	0.070
Fixed Head Spacing	38.075 (Max); 38.125 (Min)	1.500 ±0.001
Adjustable Head Spacing	38.151 (Max); 38.049 (Min)	1.500 ±0.002
Edge Margin, Minimum	0.279	1.011
Reference Track Location	1.168 (Max); 1.067 (Min)	0.044 ±0.002
Track Location Tolerance	0.051 (Max); -0.051 (Min)	±0.002
<b>Location of n<sup>th</sup> Track</b>		
<b>Track Number</b>	<b>Millimeters</b>	<b>Inches</b>
1 (Reference)	0.000	0.000
2	1.829 (Max); 1.727 (Min)	0.070
3	3.607 (Max); 3.505 (Min)	0.140
4	5.385 (Max); 5.283 (Min)	0.210
5	7.163 (Max); 7.061 (Min)	0.280
6	8.941 (Max); 8.839 (Min)	0.350
7	10.719 (Max); 10.617 (Min)	0.420
8	12.497 (Max); 12.395 (Min)	0.490
9	14.275 (Max); 14.173 (Min)	0.560
10	16.053 (Max); 15.951 (Min)	0.630
11	17.831 (Max); 17.729 (Min)	0.700
12	19.609 (Max); 19.507 (Min)	0.770
13	21.387 (Max); 21.285 (Min)	0.840

14	23.165 (Max); 23.063 (Min)	0.910
Note 1. Refer to <a href="#">Figure A.2-9</a> .		

**Table A.2-6. Dimensions - Recorded Tape Format - 14 Tracks In-Line On 25.4 mm (1 inch) Wide Tape<sup>(1)</sup>**

Parameters	Millimeters	Inches
Track Width	0.660 (Max); 0.610 (Min)	0.25 ±0.001
Track Spacing	1.778	0.070
Edge Margin, Minimum <sup>(2)</sup>	1.118 (Max); 0.044 (Min)	
Reference Track Location	0.698 (Max); 0.622 (Min)	0.0260 ±0.0015
Track Location Tolerance	0.038 (Max); -0.038 (Min)	±0.0015
Location of n <sup>th</sup> track		
Track Number	Millimeters	Inches
1 (Reference)	0.000	0.000
2	1.816 (Max); 1.740 (Min)	0.070
3	3.594 (Max); 3.518 (Min)	0.140
4	5.372 (Max); 5.296 (Min)	0.210
5	7.150 (Max); 7.074 (Min)	0.280
6	8.928 (Max); 8.852 (Min)	0.350
7	10.706 (Max); 10.630 (Min)	0.420
8	12.484 (Max); 12.408 (Min)	0.490
9	14.262 (Max); 14.186 (Min)	0.560
10	16.040 (Max); 15.964 (Min)	0.630
11	17.818 (Max); 17.742 (Min)	0.700
12	19.596 (Max); 19.520 (Min)	0.770
13	21.374 (Max); 21.298 (Min)	0.840
14	23.152 (Max); 23.076 (Min)	0.910

Notes:  
1. Refer to [Figure A.2-9](#).  
2. Track location and spacing are the same as the odd tracks of the 28-track interlaced format (see [Table A.2-7](#)). The minimum edge margin for track 1 is only 0.044 mm (0.009 inch).

**Table A.2-7. Dimensions - Recorded Tape Format - 14 Tracks Interlaced On 25.4 mm (1 inch) Wide Tape<sup>(1)</sup>**

Parameters	Millimeters	Inches
Track Width	0.660 (Max); 0.610 (Min)	0.25 ±0.001
Track Spacing	0.889	0.035
Fixed Head Spacing	38.125 (Max); 38.075 (Min)	1.500 ±0.001
Adjustable Head Spacing	38.151 (Max); 38.049 (Min)	1.500 ±0.002
Edge Margin, Minimum <sup>(2)</sup>	0.229	1.009
Reference Track Location	0.699 (Max); 0.622 (Min)	0.0260 ±0.0015

Track Location Tolerance	0.038 (Max); -0.038 (Min)	±0.0015
Location of n <sup>th</sup> Track		
Track Number	Millimeters	Inches
1 (Reference)	0.000	0.000
2	0.927 (Max); 0.851 (Min)	0.035
3	1.816 (Max); 1.740 (Min)	0.170
4	2.705 (Max); 2.629 (Min)	0.105
5	3.594 (Max); 3.518 (Min)	0.140
6	4.483 (Max); 4.407 (Min)	0.175
7	5.372 (Max); 5.296 (Min)	0.210
8	6.261 (Max); 6.185 (Min)	0.245
9	7.150 (Max); 7.074 (Min)	0.280
10	8.039 (Max); 7.963 (Min)	0.315
11	8.928 (Max); 8.852 (Min)	0.350
12	9.817 (Max); 9.741 (Min)	0.385
13	10.706 (Max); 10.630 (Min)	0.420
14	11.595 (Max); 11.519 (Min)	0.455
15	12.484 (Max); 12.408 (Min)	0.490
16	13.373 (Max); 13.297 (Min)	0.525
17	14.262 (Max); 14.186 (Min)	0.560
18	15.151 (Max); 15.075 (Min)	0.595
19	16.040 (Max); 15.964 (Min)	0.630
20	16.929 (Max); 16.853 (Min)	0.665
21	17.818 (Max); 17.742 (Min)	0.700
22	18.707 (Max); 18.631 (Min)	0.735
23	19.596 (Max); 19.520 (Min)	0.770
24	20.485 (Max); 20.409 (Min)	0.805
25	21.374 (Max); 21.298 (Min)	0.840
26	22.263 (Max); 22.187 (Min)	0.875
27	23.152 (Max); 23.076 (Min)	0.910
28	24.041 (Max); 23.965 (Min)	0.945

Notes:

1. Refer to [Figure A.2-9](#).
2. Track location and spacing for the odd tracks are same as the tracks of the 14-track inline format (see [Table A.2-6](#)). Edge margin for track 1 is only 0.229 mm (0.009 in).

#### 14. Head and Head Segment Mechanical Parameters

The following describes the mechanical parameters of the head and head segments.

##### 14.1. Gap Scatter

Gap scatter shall be 0.005 mm (0.0002 in.) or less for 25.4 mm (1 in.) tape (see [Figure A.2-11](#) and Subparagraph [4.1](#)).

#### 14.2. Head Segment Gap Azimuth Alignment

The head segment gap azimuth shall be perpendicular to the head reference plane to within  $\pm 0.29$  mrad ( $\pm 1$  minute of arc).

#### 14.3. Head Tilt

The plane tangent to the front surface of the head at the center line of the head segment gaps shall be perpendicular to the head reference plane within  $\pm 0.29$  mrad ( $\pm 1$  minute of arc) for wide-band and double-density recorders (see [Figure A.2-11](#)).

#### 14.4. Record-Head Segment Gap Parameters

The parameters for the length and azimuth alignment are described in the following subparagraphs.

##### 14.4.1. Record-Head Segment Gap Length

The record gap length (the perpendicular dimension from the leading edge to the trailing edge of the gap) shall be  $2.16 \mu\text{m} \pm 0.5$  (85 microinch  $\pm 20$ ) for wide-band recorders and  $0.89 \mu\text{m} \pm 0.12$  (35 microinch  $\pm 5$ ) for double-density recorders (see Figure 6-3 of [106-11 Chapter 6](#) and Section [6](#)).

##### 14.4.2. Record-Head Stack Gap Azimuth Alignment

The record-head stack azimuth shall be perpendicular to the head reference surface to within  $\pm 0.29$  mrad ( $\pm 1$  minute of arc). See Subparagraph 1.2, Volume III, RCC Document 118 for suggested test procedure.

##### 14.4.3. Reproduce-Head Segment Gap Azimuth Alignment

The reproduce-head segment azimuth alignment shall match that of the record-head segment as indicated by reproducing a UBE frequency signal on a selected track and setting the reproduce head azimuth for the maximum output. At this azimuth setting, the output of any other track in the reproduce head shall be within 2 dB of the output at its own optimum azimuth setting (see Subparagraph 1.3, Volume III, RCC Document 118).

### 15. **Head Polarity**

Also refer to Chapter 1, Volume III, RCC Document 118 and Subparagraph [4.2](#) herein.

#### 15.1. Record-Head Segment

Each record-head winding shall be connected to its respective amplifier in such a manner that a positive going pulse referenced to system ground at the record amplifier input will result in the generation of a specific magnetic pattern on a segment of tape passing the record head in the normal direction of tape motion. The resulting magnetic pattern shall consist of a polarity sequence of south-north-north-south.

#### 15.2. Reproduce-Head Segment

Each reproduce-head segment winding shall be connected to its respective amplifier in such a manner that an area of a tape track exhibiting a south-north-north-south magnetic pattern will produce a positive going pulse with respect to system ground at the output of the reproducer amplifier.

**16. Magnetic Tape and Reel Characteristics**

It is recommended that all recorder and reproducer systems at a particular test range be calibrated for operational use against a reference tape of the type used by the range for each bandwidth class of recorder and reproducer system. Additional supplementary procurement specifications may be required to meet a particular operational requirement of the ranges.

16.1. Tape Width

The standard nominal tape width is 25.4 mm (1 in.) (see Section 25 and [Table A.2-17](#)).

16.2. Tape Guiding

The tape guidance system restricts the tape angular motion to  $\pm 0.15$  mrad ( $\pm 30$  seconds of arc) as measured by the interchannel time displacement error of outer tracks on the same head stack. Make sure the guidance system does not damage the tape.

**17. Direct Record and Reproduce Systems**

Direct recording is a method of recording information signals on magnetic tape using high-frequency ac bias recording (see definitions at Section 6.2 of [106-11 Chapter 6](#)). Two classes of systems, wide band and double density, are included in these standards (see [Table A.2-4](#)).

17.1. Direct Record Parameters

The following items describe the direct record parameters.

- a. The input impedance for wide-band and double-density recorders shall be 75 ohms nominal across the specified band.
- b. Input gain adjustment shall be provided to permit sine-wave signals of 0.35 to 3.5 V rms to be adjusted to produce standard record level.
- c. Ideally, the recorded flux level on tape versus frequency should be constant. To approach this ideal, the record amplifier transfer characteristic is basically a constant current versus frequency with a superimposed compensation characteristic to correct only for loss of recording efficiency with frequency. Results of the test described in Subparagraph 1.8 Volume III, RCC Document 118, with the output amplitude at the 2 percent UBE frequency used as the 0 dB reference, shall be no greater than the level identified in [Table A.2-8](#).

<b>Table A.2-8. Upper Band Edge Maximum Level</b>	
<b>Percent of UBE Frequency</b>	<b>dB Difference</b>
10	0.5
50	1.0
80	1.6
100	2.0

- d. Record bias setting information is contained in [Table A.2-4](#). The bias frequency shall be greater than 3.5 times the highest direct record frequency for which the recorder and reproducer system is designed.

#### 17.2. Standard Record Level

The standard record level for direct record systems is the input level of the record level set frequency, which produces an output signal containing one percent third harmonic distortion. The conditions necessary to establish the standard record level include appropriate selection of the sinusoidal reference frequency (record level set frequency) as indicated in [Table A.2-4](#) and proper reproduce amplifier termination as defined in Figure 1-10 Volume III, RCC Document 118. A one percent third-harmonic distortion content is achieved when the level of the third harmonic of the record level set frequency is 40 dB  $\pm$ 1 below the level of a sinusoidal signal of 30 percent of UBE frequency which is recorded at the standard record level (see Section [5](#) for information regarding standard test and operating practices).

#### 17.3. Reproduce Parameters

The following items describe the reproduce parameters.

- a. For wide-band and double-density recorders, the output impedance shall be 75 ohms nominal across the specified passband.
- b. When reproducing a signal at the record level set frequency (recorded at the standard record level), the output level shall be a minimum of 1 V rms with a third harmonic distortion of 1 percent and a maximum second harmonic distortion of 0.5 percent when measured across a resistive load of 75 ohms. Lack of proper output termination will not cause the reproduce amplifier to oscillate.

#### 17.4. Tape Speed and Flutter Compensation

The average or long-term tape speed must be the same during record and reproduce to avoid frequency offsets, which may result in erroneous data. To minimize this problem, a reference signal may be applied to the tape during record and the signal used to servo-control the tape speed upon reproduce; however, because servo-control systems have limited correction capabilities and to minimize the amount of equipment required at the ranges, tape speeds and servo-control signals shall conform to the following standards.

- a. The effective tape speed throughout the reel or any portion of the reel (in absence of tape-derived servo-speed control) shall be within  $\pm$ 0.2 percent of the standard speed as measured by the procedures described in Chapter 1, Volume III, RCC Document 118.
- b. Sinusoidal or square wave speed control signals are recorded on the tape for the purpose of servo-control of tape speed during playback. The operating level for speed-control signals shall be 10 dB  $\pm$ 5 below standard record level when mixed with other signals or standard record level when recorded on a separate track.
- c. The constant-amplitude speed-control signal shall be used on a separate track for optimum servo-speed correction. The speed-control signal may be mixed with other signals if recording requirements so demand and system performance permits. Mixing of the speed-control signal with certain types of signals may degrade system performance



for tapes which are to be reproduced on tape transports with low time-base error capstan drive systems (refer to manufacturer). [Table A.2-9](#) lists speed-control signal frequencies. The speed-control signal may also be used as a flutter correction signal.

- d. Signals to be used for discriminator flutter correction systems are listed in [Chapter 3](#), Table 3-5 and [Table A.2-9](#). See the previous step and [Chapter 3](#), Table 3-5 for restrictions on use of flutter correction signals.

<b>Table A.2-9. Constant Amplitude Speed Control Signals<sup>(1)</sup></b>			
Tape Speed		Frequency <sup>(2)</sup> (kHz)	
(mm/s)	(in/s)		
6096	240	400±0.01%	800±0.01%
3048	120	200±0.01%	400±0.01%
1524	60	100±0.01%	200±0.01%
762	30	50±0.01%	100±0.01%
381	15	25±0.01%	50±0.01%
190.5	7-1/2	12.5±0.01%	25±0.01%
95.5	3-3/4	6.5±0.01%	12.5±0.01%
47.6	1-7/8	3.125±0.01%	6.25±0.01%

Notes:

1. May also serve as discriminator flutter-correction reference signal (see [Chapter 3](#), Table 3-5).
2. Either set of speed-control signals may be used primarily with wideband systems, but only the higher set of frequencies is recommended for double-density systems. When interchanging tapes, care should be taken to ensure that the recorded speed-control signal is compatible with the reproduce system's speed-control electronics.

## 18. Timing, Predetection, and Tape Signature Recording

Described in the following subparagraphs are timing signal, predetection, and tape signature recording.

### 18.1. Timing Signal Recording

Modulated-carrier, time-code signals (IRIG A, IRIG B, and IRIG G) are widely used and other formats are available. When recording IRIG B time-code signals, care must be taken to ensure that low-frequency response to 100 Hz is provided. The direct record, low frequency cutoff of most wide-band recorders is 400 to 800 Hz. For these systems, IRIG B time code signals should be recorded on an FM track or on an FM subcarrier. The widest bandwidth subcarrier available should be employed to minimize time delay.<sup>3</sup> For double-density systems, all time code signals should be recorded on an FM track or an FM subcarrier.

<sup>3</sup> Timing code formats are found in IRIG standard 200-16, IRIG Serial Time Formats and IRIG standard 205-87, Parallel Binary and Parallel Binary Coded Decimal Time Code Formats.

### 18.2. Predetection Recording

Predetection signals have been translated in frequency but not demodulated. These signals will be recorded by direct (high frequency bias) recording. Parameters for these signals are in [Table A.2-10](#).

<b>Table A.2-10. Predetection Carrier Parameters</b>					
<b>Tape Speed</b>				<b>Predetection Carrier Center Frequency<sup>(1,2)</sup></b>	
Wide Band		Double Density		A (kHz)	B (kHz)
mm/s	in/s	mm/s	in/s		
6096	(240)	3048.0	(120)	1800	2400
3048	(120)	1524.0	(60)	900	1200
1524	(60)	762.0	(30)	450.0	600
762	(30)	381.0	(15)	225.0	300
381	(15)	109.5	(7.5)	112.5	150

Notes:

1. The predetection record/playback passband is the carrier center frequency  $\pm 66.7$  percent.
2. Use center frequencies in column B when data bandwidth exceeds the capabilities of those in column A.

### 18.3. Tape Signature Recording

For data processing using wide-band and double-density recorders and reproducers, a tape signature recorded before or after the data, or both before and after the data, provides a method of adjusting the reproducer head azimuth and reproduce equalization. A means is also provided for verifying the proper operation of equipment such as playback receivers and bit synchronizers used to retrieve the recorded data.

A PCM signature is recommended where primarily PCM data is recorded. A swept-frequency or white-noise signature may be used for other data such as frequency division multiplexing or wide band FM. The procedures for recording and using these signatures are given in Section [22](#). A recommended preamble/postamble signal for recorder/reproducer alignment is included in Paragraph [21](#).

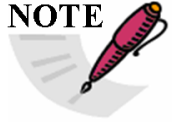
 <p><b>NOTE</b></p>	<p>Caution should be used when multiplexing other signals with the speed-control signal. In the vicinity of the frequency of the speed-control signal (<math>f_{sc} \pm 10</math> percent), the level of individual extraneous signals including spurious, harmonics, and noise must be 40 dB or more below the level of the speed-control signal. A better procedure is to leave one octave on either side of the speed-control signal free of other signals.</p>
--	--

## 19. FM Record Systems

For these FM record systems, the input signal modulates a voltage-controlled oscillator, and the output is delivered to the recording head. High frequency bias may be used but is not required. These standards shall apply.

- a. Tape and Reel Characteristics. Section [22](#) and all related subparagraphs shall apply.

- b. Tape Speeds and Corresponding FM Carrier Frequencies. See [Table A.2-11](#).  
 c. FM Record/Reproduce Parameters. See [Table A.2-11](#).

<b>Table A.2-11. Wide-band and Double-Density FM Record Parameters</b>								
Tape Speed		Carrier Center Frequency	Carrier Deviation Limits <sup>(1)</sup>		Modulation Frequency	Response Band Limits		
			Plus Deviation	Minus Deviation				
mm/s	in/s	kHz	kHz	kHz	kHz	dB <sup>(2)</sup>		
<b>Group I</b>								
47.6	1-7/8	6.750	9.450	4.050	dc to 1.250	±1		
95.2	3-3/4	13.500	18.900	8.100	dc to 2.500	±1		
190.5	7-1/2	27.000	37.800	16.200	dc to 5.000	±1		
381.0	15	54.000	75.600	32.400	dc to 10.000	±1		
762.0	30	108.000	151.200	64.800	dc to 20.000	±1		
1524.0	60	216.000	302.400	129.600	dc to 40.000	±1		
3048.0	120	432.000	604.800	259.200	dc to 80.000	±1		
<b>Group II</b>								
mm/s	in/s	47.6	1-7/8	14.062	18.281	9.844	dc to 7.810	±1, -3
		95.2	3-3/4	28.125	36.562	19.688	dc to 15.620	±1, -3
95.2	3-3/4	190.5	7-1/2	56.250	73.125	39.375	dc to 31.250	±1, -3
190.5	7-1/2	381.0	15	112.500	146.250	78.750	dc to 62.50	±1, -3
381.0	15	62.0	30	225.000	292.50	157.50	dc to 125.0	±1, -3
762.0	30	1524.0	60	450.000	585.0	315.0	dc to 250.0	±1, -3
1524.0	60	3048.0	120	900.000	1170.0	630.0	dc to 500.0	±1, -3
3048.0	120	6096.0	240	1800.000	2340.0	1260.0	dc to 1000.0	±1, -3
Notes:								
1. Input voltage levels per step e below.								
2. Frequency response referred to 1-kHz output for FM channels 13.5 kHz and above, and 100 Hz for channels below 13.5 kHz.								

- d. Speed Control and Compensation. Subsection [17.4](#) shall apply. Note that a separate track is always required for speed control and flutter compensation signals with a single-carrier FM system.
- e. FM Record Parameters. For FM record systems, an input voltage of 1 to 10V peak-to-peak shall be adjustable to produce full frequency deviation.
- f. Deviation Direction. Increasing positive voltage gives increasing frequency. Predetection recorded tapes may be recorded with reverse deviation direction because of the frequency translation techniques employed.
- g. FM Reproduce Systems. Output levels are for signals recorded at full deviation. In wide-band and double-density FM systems, the output is 2 V peak-to-peak minimum across a

load impedance of 75 ohms  $\pm$ 10 percent. Increasing input frequency gives a positive going output voltage.

## 20. PCM Recording

The PCM signals may be successfully recorded using several different methods. Methods included in these standards are predetection recording, post-detection recording, and serial HDDR. Parallel HDDR methods are not included.

### 20.1. Predetection PCM Recording

This method employs direct recording of the signal obtained by heterodyning the receiver IF signal to one of the center frequencies listed in [Table A.2-10](#) without demodulating the serial PCM signal (see [Figure A.2-12](#)). The maximum recommended bit rate for predetection recording of NRZ data is equal to the predetection carrier frequency, for example, 900 kb/s for a 900 kHz predetection carrier. The maximum recommended bit rate for predetection recording of Bi $\phi$  data is equal to one-half the predetection carrier frequency. For bit rates greater than one-half the maximum recommended rates, the preferred method of detection is to convert the signal to a higher frequency before demodulation.

### 20.2. Post-Detection PCM Recording

The serial PCM signal (plus noise) at the video output of the receiver demodulator is recorded by direct or wide band FM recording methods without first converting the PCM signal to bi-level form (see [Figure A.2-12](#)). [Table A.2-12](#) lists maximum bit rates versus tape speed for these recording methods. The minimum recommended reproduce bit rates are 10 kb/s for post-detection direct Bi $\phi$  and 10 bits per second for post-detection FM (see [Chapter 4](#), Subparagraph 4.2.2.c).

**Table A.2-12. Maximum Recommended Bit Rates, Post-Detection Recording<sup>(1)</sup>**

Tape Speed				Post-D Direct Bi $\phi$ (kb/s)	Post-FM	
Wide Band		Double Density			Bi $\phi$ (kb/s)	NRZ (kb/s)
(mm/s)	(in/s)	(mm/s)	(in/s)			
6096.0	(240)	3048.0	(120)	1800	900	1800
3048.0	(120)	1524.0	(60)	900	450	900
1524.0	(60)	762.0	(30)	450.0	225	450
762.0	(30)	381.0	(15)	225.0	112	225
381.0	(15)	109.5	(7-1/2)	112.5	56	112
190.5	(7-1/2)	95.2	(3-3/4)	56	28	56
95.2	(3-3/4)	---		28	14	28
47.6	(1-7/8)	---		14	7	14

Note:

1. Direct recording of NRZ signals is NOT recommended unless the signal format is carefully designed to eliminate low-frequency components for any data expected.

### 20.3. Serial High-Density Digital Recording

Serial HDDR is a method of recording PCM data on a magnetic tape that involves applying the data to one track of the recorder as a bi-level signal.

### 20.4. Direct Recording of PCM Telemetry Data

The following subparagraphs deal with standards for direct recording of PCM telemetry data using a wide band analog instrumentation recorder or reproducer system. Direct recording is described in Section 17. The recommended PCM codes, maximum bit rates, record and reproduce parameters, and the magnetic tape requirements are also described.

#### 20.4.1. PCM Codes

The recommended codes for serial high-density PCM recording are Bi $\phi$ -L and RNRZ-L. The maximum recommended bit packing densities (for wide band recording) are 590 bits per millimeter (b/mm) (15 kb/inch) for Bi $\phi$ -L and 980 b/mm (25 kb/inch) for RNRZ-L. Refer to [Table A.2-13](#) for maximum recommended bit rates versus standard tape speeds. The minimum recommended reproduce bit rates are 5 kb/s for Bi $\phi$ -L and 200 kb/s for RNRZ-L. Details of the implementation are discussed in Section 3.

<b>Table A.2-13. Maximum Recommended Bit Rates</b>					
<b>Tape Speed</b>				<b>Bi<math>\phi</math>-L (kb/s)</b>	<b>RNRZ-L (kb/s)</b>
<b>Wide Band</b>		<b>Double Density</b>			
(mm/s)	(in/s)	(mm/s)	(in/s)		
6096.0	(240)	3048.0	(120)	3600	6000
3048.0	(120)	1524.0	(60)	1800	3000
1524.0	(60)	762.0	(30)	900	1500
762.0	(30)	381.0	(15)	450	750
381.0	(15)	109.5	(7-1/2)	225	375
190.5	(7-1/2)	95.2	(3-3/4)	112	187 <sup>(1)</sup>
95.2	(3-3/4)	---	---	56	93 <sup>(1)</sup>
47.6	(1-7/8)	---	---	28	46 <sup>(1)</sup>

Note:  
1. Reproducing data at bit rates less than 200 kb/s is not recommended when using RNRZ-L.

#### 20.4.2. Bi $\phi$ -L Code.

The Bi $\phi$ -L code is recommended for direct recording under the following conditions: The bit rate of the data to be recorded does not exceed the maximum bit rates for Bi $\phi$ -L (see [Table A.2-13](#)), and the amount of tape required for mission recording by this method is not a severe operational constraint.

#### 20.4.3. RNRZ-L Code.

The RNRZ-L code is recommended for direct recording under any of the following conditions: the bit rate of the data to be recorded exceeds the maximum recommended bit rates for Bi $\phi$ -L (see [Table A.2-13](#)) or maximum tape recording time is needed.

- a. To minimize baseline wander anomalies, RNRZ-L is NOT recommended if the reproduced bit rate is less than 200 kb/s.

- b. The RNRZ-L shall be implemented using a 15-stage shift register and modulo-2 adders (see [Figure A.2-13](#)). The randomized bit stream to be recorded is generated by adding (modulo-2) the input bit stream to the modulo-2 sum of the outputs of the 14th and 15th stages of the shift register. In the decoder, the randomized bit stream is the input to the shift register.

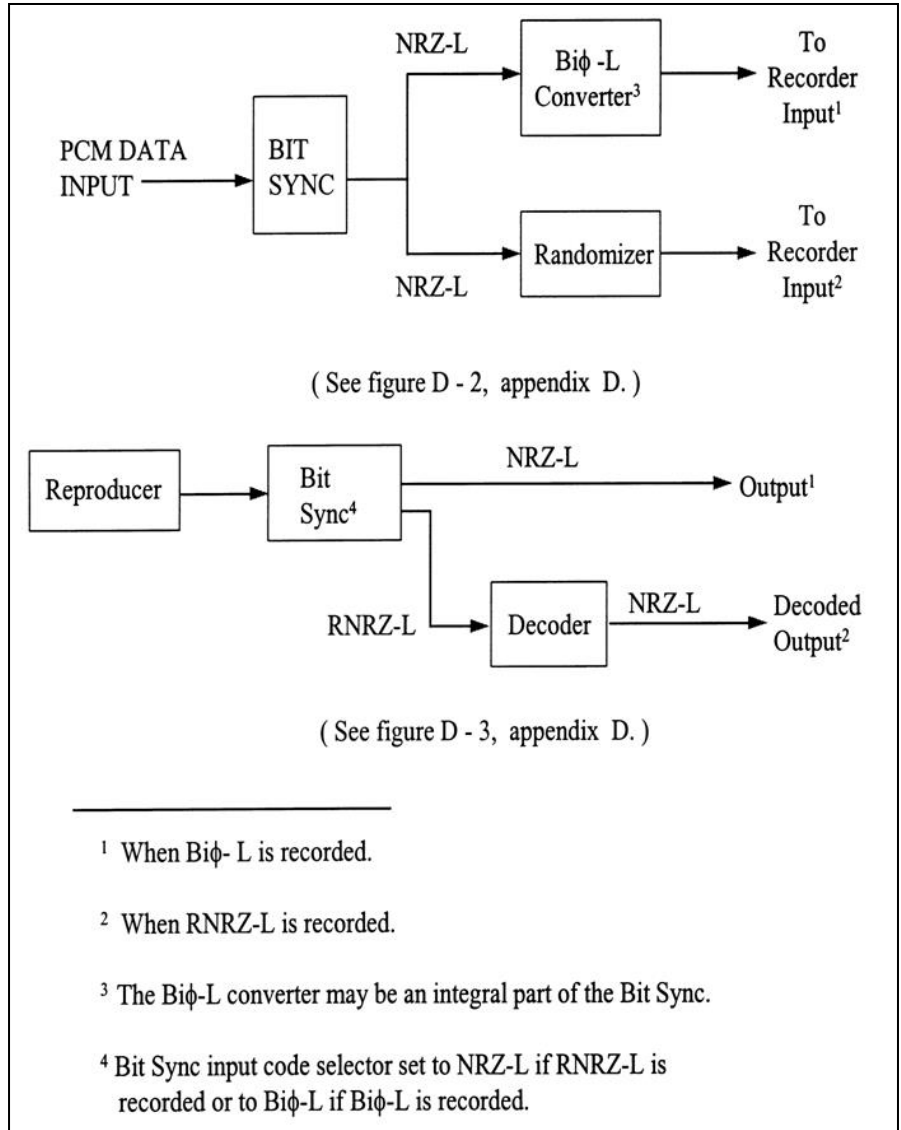

Figure A.2-13. Serial high-density digital record and reproduce

20.4.4. Record Parameters

The record parameters are explained in the following items.

- a. High-density PCM data shall be recorded in compliance with the direct record parameters detailed in Subsection [17.1](#) including the use of an ac bias signal level that produces the required 2 dB over-bias condition.

- b. The peak-to-peak level of the PCM input signal shall be equal to twice the rms value of the signal amplitude used to establish the standard record level with a tolerance of  $\pm 25$  percent (see Subparagraph [17.2](#)).
- c. The signal to be recorded must be bi-level. Bi-level signals are signals where only two levels are present. Therefore, signals containing noise must be converted to bi-level signals before they are recorded.
- d. To minimize the effects of tape dropouts, serial high-density digital data should not be recorded on the edge tracks of the tape.

#### 20.4.5. Reproduce Parameters

All reproduce parameters in Subsection [17.3](#) shall apply.

##### 20.4.5.1. PCM Signature

A PCM signature should be recorded before or after or both before and after the data to provide a method for adjusting the reproduce head azimuth and the reproducer equalizers. The data rate of the PCM signature should be the same as the rate of the data to be recorded (see Section [7](#) for tape signature recording).

##### 20.4.5.2. Phase Equalizer

Correct phase equalization is very important to the reconstruction of the serial high-density digital data. Adjustable phase equalizers are desirable but not mandatory.

#### 20.4.6. Magnetic Tape

High-density digital (HDD) magnetic tapes are recommended; however, wide band instrumentation tapes can be used on recorder and reproducer systems with 1.27 mm (0.050 inch) track widths (see Sections [22](#) through [27](#) below).

#### 20.4.7. Tape Copying

The following practices are recommended when making copies of original data tapes.

- a. Convert data reproduced from the original tape to a bi-level signal prior to recording a copy.
- b. Align reproduce head azimuth to original tape.
- c. Adjust reproducer equalizers correctly.
- d. Prior to recording the copy, use the recorded PCM signature to optimize the quality of the reproduced data.

#### 20.4.8. PCM Bit Synchronizer

The PCM bit synchronizer should contain circuitry to reestablish the baseline reference PCM signal (a dc restorer circuit). This circuit is essential when reproducing RNRZ-L at reproduced bit rates less than 1 Mb/s. The PCM bit synchronizer loop bandwidth should be selected for optimum performance between 0.1 and 3 percent of the bit rate.

 <p><b>NOTE</b></p>	<p>If an appropriate PCM bit synchronizer is not available, the tape can be copied directly; however, the SNR will be decreased.</p>
--	--

## 21. Preamble Recording for Automatic or Manual Recorder Alignment

A preamble (or postamble) may be recorded on the same tape as the data signal with known frequency and amplitude elements which will allow automatic or manual alignment of the signal electronics to optimize the performance of the playback system. Reproduce azimuth, equalization, and FM demodulator sensitivity may be adjusted at all available tape speeds. The preamble may be used for manual adjustment of any instrumentation magnetic tape recorder/reproducer (wide band and double density). Automatic adjustment requires a recorder/reproducer specifically designed with the capability to automatically adjust one or more of the following: reproduce-head azimuth, amplitude equalization, phase equalization, and FM demodulator sensitivity. The signal source may be internal to the recorder or may be externally generated.

### 21.1. Alignment, Direct Electronics

Direct electronics shall use a 1/11 band edge square wave for both manual and automatic alignment as given in this annex.

### 21.2. Alignment, FM Electronics

The FM electronics shall use a 1/11 band edge square wave and  $\pm 1.414$  Vdc or 0.05 Hz square wave for both manual and automatic alignment as given in this annex.

## 22. Magnetic Tape Standards: General

The following standards define terminology, establish key performance criteria, and reference test procedures for longitudinally-oriented oxide, unrecorded magnetic tape designed for instrumentation recording,<sup>4</sup> and reference specifications for 19 mm (0.75 in) cassettes designed for digital helical scan recording and S-VHS cassettes designed for 12.65 mm (1/2 in) digital helical scan recording. Classes of instrumentation recording tapes include high-resolution (HR) tapes used for wide band recording, HDD tapes used for high-density digital PCM recording, and high energy (HE) tapes used for double-density recording.

Coercivities of HR and HDD tapes are in the range of 275 to 350 oersteds. High-energy tapes have coercivities of 600 to 800 oersteds. Nominal base thickness is 25.4  $\mu\text{m}$  (1.0 mil) and nominal coating thickness is 5  $\mu\text{m}$  (200 microinches) for all tapes. Where required, limits are specified to standardize configurations and to establish the basic handling characteristics of the tape. Limits placed on the remaining requirements must be determined by the tape user in light of the intended application and interchangeability requirements imposed on the tape (see [Table A.2-14](#) for examples of suggested requirement limits).

<b>Table A.2-14. Suggested Tape Requirement Limits</b>		
Paragraph No.	Tape Requirement	Suggested Limits
<a href="#">27.1</a>	Bias Level	$\pm 2.0$ dB from MCT
<a href="#">27.2</a>	Record Level	$\pm 2.0$ dB from MCT
<a href="#">27.3</a>	Wavelength Response ( <a href="#">Table A.2-15</a> )	

<sup>4</sup> Federal specifications may be used to replace paragraphs contained in this chapter where applicable. High output and HDD tapes are not included in the federal specifications. Other standards are listed in [Annex A.21](#).



<a href="#">27.4</a>	Output at 0.1 UBE Wavelength	1.5 dB from MCT		
<a href="#">27.5</a>	Short Wavelength Output Uniformity	2.5 dB (HR tape); 2.5 dB (HE tape)		
<a href="#">27.6</a>	Dropouts per 30 m (100 ft) (average)	Center Tracks		Edge Tracks
		5	HR Tape	10
		1	HDD Tape	1
		20	HE Tape	30
<a href="#">27.7</a>	Durability (See <a href="#">Table A.2-16</a> )			
<a href="#">27.8</a>	Modulation Noise	1 dB maximum		

**Table A.2-15. Suggested Wavelength Response Requirements**

<b>HR and HDD Tape</b>			
Measurement Wavelength		HR Response (dB)	HDD Response (dB)
( $\mu\text{m}$ )	(mils)		
3810.00	(150.000)	1.00	2.00
254.00	(10.000)	1.00	1.00
15.14	(0.600)	0.00	0.00
6.35	(0.250)	1.50	1.50
3.18	(0.125)	2.00	2.00
2.54	(0.100)	2.50	2.50
2.03	(0.080)	2.50	2.50
1.52	(0.060)	3.00	3.00
<b>High-Energy Tape</b>			
Measurement Wavelength		HE Wavelength Response (dB)	
( $\mu\text{m}$ )	(mils)		
25.40	(1.000)	2.00	
12.70	(0.500)	2.00	
7.62	(0.300)	0.00	
3.18	(0.125)	2.50	
1.52	(0.060)	2.50	
1.02	(0.040)	3.00	
0.76	(0.030)	3.50	

**Table A.2-16. Durability Signal Losses**

Designated Tape Length		Number of Allowable Signal Losses (per pass)
Meters	Feet	
762	(2500)	2
1097	(3600)	2
1402	(4600)	2
1524	(5000)	2
2195	(7200)	3
2804	(9200)	3
3292	(10,800)	4

### 23. Definitions

Underlined terms appearing within definitions indicate that these terms are defined elsewhere in Section 23.0. For the purpose of this standard, the following definitions apply.

Back Coating. A thin coating of conductive material (for example, carbon) bonded to the surface of a magnetic tape opposite the magnetic-coated surface for reducing electrostatic charge accumulation and for enhancing high-speed winding uniformity. Resistivity of the back coating should be 1 megohm per square or less, whereas the oxide-coated magnetic surface resistivity is much higher (also see magnetic oxide coating).

Base. The material on which the magnetic oxide coating (and back coating, if employed) is applied in the manufacture of magnetic tapes. For most applications, polyester-base materials are currently employed.

Bias Level. The level of high frequency ac bias current or voltage in a direct record system needed to produce a specified level of a UBE frequency sine-wave signal at a particular tape speed. Bias level is usually adjusted to produce maximum output or increased beyond maximum to depress the output 2 dB.

Bi-Directional. Ability of a magnetic tape to record and to reproduce a specified range of signals within specified tolerances of various characteristics when either end of the tape on the reel is used as the leading end.

Binder. Material in which the magnetic oxide particles or back-coating particles are mixed to bond them to the base material.

Blocking. Failure of the magnetic coating to adhere to the base material because of layer-to-layer adhesion in a wound tape pack.

Center Tracks. On a recorded tape, center tracks are those that are more than one-track distance from either edge of the tape, for example, tracks 2 through 13 of a 14-track tape or tracks 2 through 27 of a 28-track tape.

Dropout. A reproduced signal of abnormally low amplitude caused by tape imperfections severe enough to produce a data error. In digital systems, dropouts produce bit errors.

Edge Tracks. The data tracks nearest the two edges of a recorded magnetic tape, for example, tracks 1 and 14 of a 14-track tape.

Erase. Removal of signals recorded on a magnetic tape to allow reuse of the tape or to prevent access to sensitive or classified data. Instrumentation recorders and reproducers do not usually have erase heads, so bulk erasers or degaussers must be employed.

E-Value. The radial distance by which the reel flanges extend beyond the outermost layer of tape wound on a reel under a tape tension of 3.33 to 5.56 newtons (12 to 20 ounces of force) per inch of tape width. Inadequate E-value may prohibit the use of protective reel bands.

High-Density Digital Magnetic Tape. Instrumentation magnetic tape with nominal base thickness of 25.40  $\mu\text{m}$  (1 mil) and coercivity of 275 to 350 oersteds used to record and reproduce high-density digital (PCM) signals with per-track bit densities of 590 b/mm (15 kb/inch) or greater.

High-Energy Magnetic Tape. Magnetic tapes having coercivity of 600 to 800 oersteds and nominal base thickness of 25.4  $\mu\text{m}$  (1 mil) used for double-density analog recording and high-density digital recording above 980 b/mm (25 kb/inch).

High-Resolution Magnetic Tape. Instrumentation magnetic tape used for recording on wide band recorder and reproducer systems. The HR and HDD tapes may have identical coatings

and coercivities (275 to 350 oersteds) but differ in the extent and type of testing conducted by the manufacturer.

Layer-to-Layer Signal Transfer (Print Through). Transfer of a signal to a layer of a wound magnetic tape originating from a signal recorded on an adjacent layer of tape on the same reel. Saturation-level recorded signals and tape storage at elevated temperatures are likely contributors to this effect.

Magnetic Oxide Coating. Material applied to a base material to form a magnetic tape. The magnetic oxide coating contains the oxide particles, the binder, and other plasticizing and lubricating materials necessary for satisfactory operation of the magnetic tape system (also see back coating).

Manufacturer's Centerline Tape (MCT). A tape selected by the manufacturer from his production, where the electrical and physical characteristics are employed as reference standards for all production tapes to be delivered during a particular contractual period. Electrical characteristics include, but are not limited to, bias level, record level, output at 0.1 UBE, and wavelength response. The MCTs are not usually available for procuring agency use.

Manufacturer's Secondary Centerline Tape (MSCT). A tape selected by a manufacturer from his production and provided in lieu of an MCT. On the MSCT, the electrical characteristics may depart from the MCT characteristics, but calibration data referenced in the MCT are provided. All other characteristics of the MSCT are representative of the manufacturer's product.

Modulation Noise. Noise riding on a reproduced signal that is proportional to the amplitude of the recorded signal (below saturation) and results from tape-coating irregularities in particle size, orientation, coercivity, and dispersion.

Record Level. The level of record current or voltage required to achieve a specified reproduce output level with bias level previously set to the correct value. In direct record systems, standard record level is the level of a 0.1 UBE frequency signal required to produce 1 percent third harmonic distortion in the reproduced output signal because of tape saturation.

Scatterwind. Lateral displacements of tape wound on a reel which gives an irregular appearance to the side surfaces of a tape pack. Scatterwind can result from such things as poorly controlled tape tension, guiding, static electrical charge, and poor tape slitting.

Shedding. Loss of magnetic coating from tape during operation on a tape transport. Excessive shedding causes excessive dropout.

Short Wavelength Output Uniformity. A measure of high-frequency reproduce signal amplitude uniformity caused by oxide coating variations.

Upper Band Edge. The highest frequency that can be recorded and reproduced at a particular tape speed in the direct record mode. The UBE signals are used in setting bias level; 0.1 UBE signals are used to set record level.

Wavelength Response. The record and reproduce characteristic of a magnetic tape which depends on tape formulation, coating thickness, and other tape physical parameters and is a function of the wavelength recorded on the tape (tape speed divided by signal frequency) rather than the actual frequency recorded.

Working Length. Length of tape usable for reliable recording and reproduction of data. Actual tape length on a reel exceeds the working length to provide for tape start and stop at each end of the reel without loss of data.

Working Reference Tape (WRT). A tape or tapes of the same type as an MCT or MSCT selected by the user and calibrated to the MCT or MSCT. The WRTs are employed in conducting tests on tape types during a procurement activity and for aligning and testing recorder and reproducer systems to minimize running the MCT or MSCT.

**24. General Requirements for Standard Instrumentation Tapes and Reels**

The following subparagraphs describe the requirements for tapes and reels.

**24.1. Reference Tape System**

To establish a set of test procedures that can be performed independently and repeatedly on different manufacturers' tape transports, a centerline reference tape system employing MCT, MSCT, or WRTs as required, should be used. The reference tape system provides a centerline tape against which tape or tape recorder specifications may be tested or standard tapes for aligning operational recorders.

**24.1.1. Manufacturer's Centerline Tape**

The electrical characteristics provided for a manufacturer's centerline tape include, but are not limited to, bias level, record level, wavelength response, and output at 0.1 UBE wavelength. The physical characteristics of the MCT shall also represent the manufacturer's production and shall be representative of all production tape delivered during any resultant contractual period (see MCT definition in Section 23)

**24.1.2. Manufacturer's Secondary Centerline Tape**

On the MSCT, the electrical characteristics are calibrated to the manufacturer's reference tape, and calibration data are supplied with the MSCT. The physical characteristics of the MSCT shall represent the manufacturer's production (see secondary MSCT definition in Section 23).

**24.1.3. Working Reference Tape**

Working reference tapes shall be of the same type as those under procurement or test and shall be used in place of a MCT or MSCT for all applicable test procedures (see WRT definition in Section 23).

 <p><b>NOTE</b></p>	<p>The MCT or MSCT shall be a full-length tape of 25.4 mm (1 in.) width, wound on a 266.7 mm (10 1/2 in.) or 355.6 mm (14 in.) reel or as designated by the tape user. The center one-third of the working tape length shall be used as the calibrated working area.</p>
--	--

**24.1.4. Test Recorder and Reproducer**

A laboratory quality test recorder shall be designated for use with the reference tape system during any magnetic tape procurement and test program. The recorder selected shall meet the requirements specified in this annex.

**24.1.5. MCT/MSCT/WRT Use**

Using MCT or MSCT as a reference, the tape user performs all tests necessary to determine if the manufacturer's centerline performance values meet operational and recorder requirements. All acceptable centerline tapes are retained by the tape user as references in subsequent acceptance test procedures performed in support of resultant contracts or contractual periods. A working reference tape, which has been calibrated to an MCT or MSCT, is used as the

actual working reference in the applicable testing procedures outlined in Volume III, RCC Document 118. Dropout tests should use a tape other than the MSCT or WRT.

24.2. Marking and Identifying

See Federal Specification W-T-1553B.<sup>5</sup>

24.3. Packaging

Specified by user.

24.4. Winding

The tape shall be wound on the reel or hub with the oxide surface facing toward the hub (“A” wind). The front of the wound reel is defined as that flange visible when viewing the tape reel with the loose end of the tape hanging from the viewer's right.

24.5. Reels and Hubs

Reels and hubs shall conform to the tape user specified requirements of Federal Specification W-R-175.<sup>6</sup>

24.6. Radial Clearance (E-Value)

For all tape lengths, use 3.175 mm (0.125 inch), (See E-Value definition in Section 23).

24.7. Flammable Materials

Flammable materials shall not be a part of the magnetic tape. Flammable materials will ignite from a match flame and will continue to burn in a still carbon dioxide atmosphere.

24.8. Toxic Compounds

Compounds that produce toxic effects in the environmental conditions normally encountered under operating and storing conditions as defined in Subsection 25.2 shall not be part of the magnetic tape. Toxicity is defined as the property of the material that has the ability to do chemical damage to the human body. Highly toxic or corrosive compounds produced under conditions of extreme heat shall be identified and described by the manufacturer.

**25. General Characteristics of Instrumentation Tapes and Reels**

The following subparagraphs describe the general characteristics for tapes and reels.

---

<sup>5</sup> General Services Administration. “General Specification for Tape, Instrumentation, Recording, Magnetic Oxide-Coated.” Federal Specification W-T-1553B. 12 August 1996. Canceled with no replacement. Retrieved 17 May 2021. Available at [https://quicksearch.dla.mil/qsDocDetails.aspx?ident\\_number=49387](https://quicksearch.dla.mil/qsDocDetails.aspx?ident_number=49387).

<sup>6</sup> General Services Administration. “General Specification for Reels and Hubs for Magnetic Recording Tape.” W-R-175D. 22 December 1986. Canceled with no replacement. Retrieved 17 May 2021. Available at [https://quicksearch.dla.mil/qsDocDetails.aspx?ident\\_number=49028](https://quicksearch.dla.mil/qsDocDetails.aspx?ident_number=49028).

### 25.1. Dimensional Specifications

Magnetic tape shall be supplied on flanged reels in the standard lengths, widths, and base thicknesses outlined in [Table A.2-17](#). Reel and hub diameters are taken from Federal Specification W-R-175.

<b>Table A.2-17. Tape Dimensions</b>			
<b>Dimension</b>	<b>Millimeters</b>	<b>Inches</b>	
Tape Width	25.4 +0 -0.10	1.000 +0 -0.004	
Tape Thickness			
Base Material	0.025	0.0010	Nominal <sup>(1)</sup>
Oxide Thickness	0.005	0.0002	Nominal
<b>Tape Length by Reel Diameters (reels with 76 mm (3 in.) center hole)</b>			
Reel Diameter	Nominal Tape Length <sup>(2)</sup>	Minimum True Length <sup>(3)</sup>	
266 mm (10.5 in.)	1100 m (3600 ft)	1105 m (3625 ft)	
" " " "	1400 m (4600 ft)	1410 m (4625 ft)	
356 mm (14.0 in.)	2200 m (7200 ft)	2204 m (7230 ft)	
" " " "	2800 m (9200 ft)	2815 m (9235 ft)	
381 mm (15.0 in.)	3290 m (10,800 ft)	3303 m (10,835 ft)	
408 mm (16.0 in.)	3800 m (12,500 ft)	3822 m (12,540 ft)	
Notes:			
1. Actual tape base material thickness slightly less because of manufacturing conventions.			
2. Original dimensions are in feet. Metric conversions are rounded for convenience.			
3. Tape-to-flange radial clearance (E-value) is 3.18 mm (0.125 in.).			

### 25.2. Environmental Conditions

The tape shall be able to withstand, with no physical damage or performance degradation, any natural combination of operating or non-operating conditions as defined in subparagraphs [25.2.1](#) and [25.2.2](#) immediately below.

#### 25.2.1. Tape Storing Conditions

Magnetic tape is subject to deterioration at temperature and humidity extremes. In some cases, the damage is reversible, but irreversible damage may occur, especially with long-term storage in unfavorable conditions.

#### 25.2.2. Operating Environment

[Table A.2-18](#) depicts recommended limits.

<b>Table A.2-18. Environment Recommended Limits</b>	
<b>Condition</b>	<b>Range</b>
Temperature	4 to 30°C (40 to 85°F)
Humidity	20 to 60 percent relative humidity (RH) non-condensing
Pressure	Normal ground or aircraft operating altitude pressures. For very high altitudes, tape users should consult with

	manufacturers to determine if tape and recorder compatibility is affected by low atmospheric pressure.
--	--

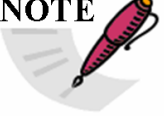
 <b>NOTE</b>	<ol style="list-style-type: none"><li>1. Binder/oxide system tends to become sticky and unusable above 50°C (125°F).</li><li>2. In low humidity, tape binder and oxide system tends to dry out, and oxide and binder adhesion can be unsatisfactory. Brown stains on heads may appear below 40 percent RH.</li><li>3. In high humidity, abrasivity is increased and other performance problems may arise.</li></ol>
---	---

### 25.2.3. Non-operating Environment

Temperature and Relative Humidity:

Short Term: 0 to 45°C (32 to 115°F) and 10 to 70 percent RH non-condensing

Long Term: 1 to 30°C (33 to 85°F) and 30 to 60 percent RH non-condensing

 <b>NOTE</b>	Experience has shown that with long exposure to temperatures below freezing, lubricants and plasticizers tend to migrate out of the oxide coating thereby resulting in poor lubrication and gummy surface deposits.
---	---

### 25.3. Other Characteristics

Storage life, bi-directional performance, frictional vibration, and scatterwind characteristics shall conform to Federal Specification W-T-1553 unless otherwise specified by the tape user at the time of purchase.

## 26. **Physical Characteristics of Instrumentation Tapes and Reels**

As specified in Federal Specifications W-T-1553B, W-T-1553/1-4,<sup>7</sup> and W-R-175.

## 27. **Instrumentation Tape Magnetic and Electrical Characteristics**

The following subparagraphs describe required magnetic and electrical tape characteristics.

---

<sup>7</sup> General Services Administration. "Tape, Instrumentation Recording, Magnetic Oxide-Coated, 345 Oersteds Coercivity, 5 Dropouts per 100 Foot..." Federal Specification W-T-1553/1. 12 August 1996. Canceled with no replacement. -General Services Administration. "Tape, Instrumentation Recording, Magnetic Oxide-Coated, 345 Oersteds Coercivity, 4 Dropouts per 100 Foot..." Federal Specification W-T-1553/2. 12 August 1996. Canceled with no replacement. -General Services Administration. "Tape, Instrumentation Recording, Magnetic Oxide-Coated, 700 Oersteds Coercivity, 4 Dropouts Per 100 Foot..." Federal Specification W-T-1553/3. 12 August 1996. Canceled with no replacement. -General Services Administration. "Tape, Instrumentation Recording, Magnetic Oxide-Coated, 800 Oersteds Coercivity, 2 Dropouts Per 100 Foot..." Federal Specification W-T-1553/4. 12 August 1996. Canceled with no replacement. Retrieved 16 April 2019. All W-T-1553 documents available at <http://quicksearch.dla.mil/qsSearch.aspx>.

27.1. Bias Level

The bias level (see bias level definition in Section 23) required by the magnetic tape shall not differ from the bias level requirements of the reference tape by more than the amount specified by the tape user. The test procedure outlined in Subparagraph 5.3.8.1, Bias Level, Volume III of RCC Document 118 shall be used to determine compliance with this requirement.

27.2. Record Level

The record level (see record level definition in Section 23) required by the magnetic tape shall not differ from the record level requirements of the reference tape by more than the amount specified by the tape user. The test procedure outlined in Subparagraph 5.3.8.2, Record Level, Volume III of RCC Document 118 shall be used to determine compliance with this requirement.

27.3. Wavelength Response

The output of the magnetic tape, measured at the wavelength values listed in Table A.2-19, shall not differ from the output of the reference tape by more than the amounts specified by the tape user. Wavelength response requirements shall be specified in terms of output after having normalized the output to zero decibels at the 0.1 UBE wavelength. The test procedure outlined in Subparagraph 5.3.9, Wavelength Response and Output at 0.1 Upper Band Edge Wavelength, Volume III of RCC Document 118 shall be used to determine compliance with this requirement (see Table A.2-15).

<b>Table A.2-19. Measurement Wavelengths</b>			
<b>High-Resolution and HDD Tape</b>		<b>High-Energy Tape</b>	
( $\mu\text{m}$ )	(mils)	( $\mu\text{m}$ )	(mils)
3810.00	(150.000)	254.00	(10.000)
254.00	(10.000)	25.40	(1.000)
25.40	(1.000)	12.70	(0.500)
6.35	(0.250)	6.35	(0.250)
3.18	(0.125)	3.18	(0.125)
2.54	(0.100)	2.54	(0.100)
2.03	(0.080)	1.52	(0.060)
1.52	(0.060)	1.02	(0.040)
		0.76	(0.030)

27.4. Output at 0.1 UBE Wavelength

The wavelength output of the magnetic tape shall not differ from the 0.1 UBE wavelength of the reference tape by more than the amount specified by the tape user. The test procedure outlined in Subparagraph 5.3.9, Wavelength Response and Output at 0.1 Upper Band Edge Wavelength, Volume III of RCC Document 118 shall be used to determine compliance with this requirement.



### 27.5. Short Wavelength Output Uniformity

The short wavelength output of the magnetic tape shall be consistently uniform so that a signal recorded and reproduced throughout the working tape length in either direction of longitudinal tape motion shall remain free from long-term amplitude variation to the extent specified by the tape user. The test procedure outlined in Subparagraph 5.3.10, Short Wavelength Output Uniformity, Volume III of RCC Document 118 shall be used to determine compliance with this requirement.

### 27.6. Dropouts

The instantaneous non-uniformity (dropout) output of a recorded signal, caused by the magnetic tape, shall not exceed the center-track and edge-track limits specified by the tape user on the basis of dropouts per 30.48 m (100 ft.) of nominal working tape length. The nominal dropout count shall be determined by totaling all the dropouts per track over the working tape length and dividing by the total number of 30.48 m (100 ft.) intervals tested.

A second method of specifying the allowable dropout count is to specify the maximum number per track for each 30.48 m (100 ft.) interval tested. This method may be preferred if critical data is recorded in specific areas of the working tape length, but a specified number of dropouts per hundred feet greater than the average values may be expected.

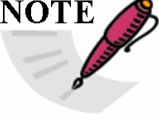
 <p><b>NOTE</b></p>	<p>Dropout test results are very dependent on the tape transport used for the test and will vary from run to run on a given transport. Edge tracks tend to contain more dropouts than the center tracks, and more dropouts are allowed on the edge tracks. Refer to <a href="#">Table A.2-14</a>.</p>
---	---

For HR tapes, a dropout is defined as a 6 dB reduction in amplitude for a period of 5 microseconds or more of a 1 MHz sine-wave signal recorded and reproduced at a tape speed of 3048 mm/s (120). Signal losses of 6 dB or more which exceed the 5 microsecond time period shall constitute a dropout count for each 5 microsecond time period occurring in the given signal loss. The definitions for center tracks and edge tracks are in Section 23. The test procedure outlined in Subparagraph 5.3.11, Volume III of RCC Document 118 shall be used to determine compliance with this requirement.

For HDD tapes, a dropout is defined as a 10 dB or greater reduction in amplitude for a period of 1 microsecond or more of a square-wave test signal of maximum density recorded and reproduced at 3048 mm/s or 1524 mm/s (120 in/s or 60 in/s). On at least every other track (7 tracks of the odd head on a 28-track head assembly (alternatively, every other track of the even head) record and reproduce a square-wave test signal of 2 MHz at 3048 mm/s (120 in/s) or 1 MHz at 1524 mm/s (60 in/s). The record level shall be set slightly above saturation by adjusting the record current to produce maximum reproduce output and increasing the record current until the output signal is reduced to 90 percent of maximum. For playback, a reproduce amplifier and a threshold detector shall be used. The signal-to-noise ratio of the test signal at the input to the threshold detector shall be at least 25 dB, and the detector shall detect any signal loss of 10 dB or more below reference level. The reference level shall be established by averaging the test signal output level over a 10 m (30.8 ft.) nominal tape length in the vicinity of a dropout.

For each of the seven tracks tested, the accumulated duration in microseconds of detected dropout events shall be displayed and used to directly display the dropout rate for each track

scaled appropriately for the tape working length. Signal losses of 10 dB or more which exceed the 1 microsecond time period shall constitute a dropout count for each microsecond time period occurring in the given signal loss.

For high-energy tapes, a dropout is defined as for high-resolution tapes except that a 2-MHz signal is used.

#### 27.7. Durability

The magnetic tape shall resist deterioration in magnetic and electrical performance because of wear to the coating surface. Signal losses, as defined below, caused by surface wear shall not occur in excess of the per-pass limits specified in [Table A.2-16](#) for the first 35 passes.

Signal losses in excess of those limits specified above shall not occur during either a record, record and reproduce or uninterrupted reproduce pass of the working tape length. Signal loss is a reduction in signal amplitude of 3 dB or greater for a period of 3 through 10 seconds of a recorded and reproduced short wavelength signal. Where a continuous loss of signal of 3 dB or greater exceeds the 10-second period, a signal loss count shall be required for every sequential 10-second time period occurring in the given signal loss. The test procedure outlined in Subparagraph 5.3.12, Durability, Volume III of RCC Document 118 shall be used to determine compliance with this requirement.

#### 27.8. Modulation Noise

The amplitude modulation superimposed upon a recorded and reproduced signal by the magnetic tape shall not exceed the limits specified by the tape user. The test procedure outlined in Subparagraph 5.3.13, Modulation Noise, Volume III of RCC Document 118 shall be used to determine compliance with this requirement.

#### 27.9. Layer-to-Layer Signal Transfer

A signal resulting from layer-to-layer signal transfer shall be reduced in amplitude from the original signal a minimum of 40 dB for 25.4  $\mu\text{m}$  (1.0 mil) tape and 46 dB for 38.1  $\mu\text{m}$  (1.5 mils) tape. The test procedure outlined in Subparagraph 5.3.14, Layer-to-Layer Signal Transfer, Volume III of RCC Document 118 shall be used to determine compliance with this requirement.

#### 27.10. Erase Ease

For HR and HDDR tapes, an erase field of 79.58 kiloamps per meter (kA/m) (1000 oersteds) shall effect at least a 60 dB reduction in output amplitude of a previously recorded 25.4  $\mu\text{m}$  (1.0 mil) wavelength signal. For HE tapes, an erase field of 160 kA/m (2000 oersteds) shall effect at least a 60 dB reduction of a previously recorded 25.4  $\mu\text{m}$  (1.0 mil) wavelength signal. The test procedure outlined in Subparagraph 5.3.15, Volume III of RCC Document 118 shall be used to determine compliance with this requirement.

#### 27.11. Suggested Tape Requirement Limits

[Table A.2-14](#) lists some suggested limits to be used for instrumentation tape.

## ANNEX B

### Citations

- General Services Administration. "General Specification for Tape, Instrumentation, Recording, Magnetic Oxide-Coated." Federal Specification W-T-1553B. 12 August 1996. Canceled with no replacement. Retrieved 17 May 2021. Available at [https://quicksearch.dla.mil/qsDocDetails.aspx?ident\\_number=49387](https://quicksearch.dla.mil/qsDocDetails.aspx?ident_number=49387).
- . "General Specification for Reels and Hubs for Magnetic Recording Tape." W-R-175D. 22 December 1986. Canceled with no replacement. Retrieved 17 May 2021. Available at [https://quicksearch.dla.mil/qsDocDetails.aspx?ident\\_number=49028](https://quicksearch.dla.mil/qsDocDetails.aspx?ident_number=49028).
- . "Tape, Instrumentation Recording, Magnetic Oxide-Coated, 345 Oersteds Coercivity, 4 Dropouts per 100 Foot..." Federal Specification W-T-1553/2. 12 August 1996. Canceled with no replacement. Retrieved 17 May 2021. Available at [https://quicksearch.dla.mil/qsDocDetails.aspx?ident\\_number=121475](https://quicksearch.dla.mil/qsDocDetails.aspx?ident_number=121475).
- . "Tape, Instrumentation Recording, Magnetic Oxide-Coated, 345 Oersteds Coercivity, 5 Dropouts per 100 Foot..." Federal Specification W-T-1553/1. 12 August 1996. Canceled with no replacement. Retrieved 17 May 2021. Available at [https://quicksearch.dla.mil/qsDocDetails.aspx?ident\\_number=121474](https://quicksearch.dla.mil/qsDocDetails.aspx?ident_number=121474).
- . "Tape, Instrumentation Recording, Magnetic Oxide-Coated, 700 Oersteds Coercivity, 4 Dropouts Per 100 Foot..." Federal Specification W-T-1553/3. 12 August 1996. Canceled with no replacement. Retrieved 17 May 2021. Available at [https://quicksearch.dla.mil/qsDocDetails.aspx?ident\\_number=121476](https://quicksearch.dla.mil/qsDocDetails.aspx?ident_number=121476).
- . "Tape, Instrumentation Recording, Magnetic Oxide-Coated, 800 Oersteds Coercivity, 2 Dropouts Per 100 Foot..." Federal Specification W-T-1553/4. 12 August 1996. Canceled with no replacement. Retrieved 17 May 2021. Available at [https://quicksearch.dla.mil/qsDocDetails.aspx?ident\\_number=121477](https://quicksearch.dla.mil/qsDocDetails.aspx?ident_number=121477).
- Range Commanders Council. *IRIG Serial Time Code Formats*. IRIG Standard 200-16. May be superseded by update. Retrieved 17 May 2021. Available at <https://www.trmc.osd.mil/wiki/x/wou8Bg>.
- . *IRIG Standard Parallel Binary and Parallel Binary Coded Decimal Time Code Formats*. IRIG Standard 205-87. May be superseded by update. Retrieved 17 May 2021. Available to RCC members with Private Page access at <https://www.trmc.osd.mil/wiki/x/9IVyBQ>.
- . *Test Methods for Recorder and Reproducer Systems and Magnetic Tape*. Volume III. RCC 118-99. May be superseded by update. Retrieved 17 May 2021. Available at <https://www.trmc.osd.mil/wiki/x/fou8Bg>.

———. *Test Methods for Telemetry Systems and Subsystems*. Volume IV. RCC 118-79. May be superseded by update. Retrieved 17 May 2021. Available at <https://www.trmc.osd.mil/wiki/x/glu8Bg>.

**\*\*\*\* END OF ANNEX A.2 \*\*\*\***

## ANNEX A-3

### ADARIO Data Block Field Definitions

<b>Acronyms</b> .....		<b>A.3-iii</b>
<b>Annex A.3. ADARIO Data Block Field Definitions</b> .....		<b>A.3-1</b>
<b>1. Data Block Format and Timing</b> .....		<b>A.3-1</b>
<b>2. ADARIO Data Format Field Definitions Summary</b> .....		<b>A.3-4</b>
2.1. Block Length.....		A.3-4
2.2. Session Header.....		A.3-4
2.3. Channel ‘n’ Header.....		A.3-5
<b>3. Submux Data Format Field Definitions</b> .....		<b>A.3-9</b>
<b>4. SubMux Data Format Field Definitions Summary</b> .....		<b>A.3-13</b>
4.1. Frame length.....		A.3-13
4.2. Block length.....		A.3-13
4.3. Block sync.....		A.3-13
4.4. General form.....		A.3-13
4.5. Block Sync.....		A.3-14
4.6. Time Tag.....		A.3-14
4.7. Annotation Text.....		A.3-15
4.8. Digital Serial External Clock.....		A.3-15
4.9. Digital Serial Internal Clock.....		A.3-16
4.10. Digital Parallel External Clock.....		A.3-17
4.11. Analog Wide Band.....		A.3-17
4.12. Analog Stereo “L” & “R”.....		A.3-18
4.13. Fill.....		A.3-19

#### List of Figures

Figure A.3-1. ADARIO Data Format.....		A.3-2
Figure A.3-2. ADARIO Data Blocks.....		A.3-3
Figure A.3-3. ADARIO Timing.....		A.3-4
Figure A.3-4. Submux Aggregate Format.....		A.3-12

#### List of Tables

Table A.3-1. User Data Word Size.....		A.3-5
Table A.3-2. Submux Data Format.....		A.3-10
Table A.3-3. Submux Data Format (Continuation).....		A.3-11

This page intentionally left blank.

## Acronyms

ADARIO	Analog/Digital Adaptable Recorder Input/Output
BCD	binary coded decimal
BM	block marker
BMD	block marker divisor
BW	bandwidth
Hz	hertz
LIFO	last-in-first-out
LSB	least significant bit
Mbps	megabits per second
MHz	megahertz
MSB	most significant bit
MC	master clock
PW	partial word
TBD	to be defined

This page intentionally left blank.



## ANNEX A.3

### ADARIO Data Block Field Definitions

#### 1. Data Block Format and Timing

The details of the Analog/Digital Adaptable Recorder Input/Output (ADARIO) data block format are provided in [Figure A.3-1](#) and in the ADARIO data format field summary. As shown in [Figure A.3-1](#), the eight session header words are the first eight words of the block. The channel packet for the highest priority (priority 1) channel is next, followed by the next lower priority channel packet (priority 2). Following the lowest priority channel, fill data consisting of all ones are inserted as required completing the 2048-word data block.

Within the channel packet, the first five words are the channel header words including the partial word (PW). Following the channel header is the variable size channel data field. The channel data are organized in a last-in-first-out (LIFO) fashion. The first samples acquired in the block time interval appear in the last data word of the channel packet. The sample data are formatted into the 24-bit data word such that the first sample occupies the most significant bits (MSBs) of the word. The next sample is formatted into the next available MSBs and so on until the word is full. As an example, data formatted into 8-bit samples is shown in [Figure A.3-2](#).

In cases where the 24-bit data word is not a multiple of the sample size, the sample boundaries do not align with the data words. In these cases, the samples at the word boundaries are divided into two words. The MSBs of the sample appear in least significant bits (LSBs) of the first buffered word and the LSBs of the sample appear in the MSBs of the next buffered word. Since the channel data appears in a LIFO fashion in the ADARIO data block, the MSBs of the divided sample will occur in the data word following the word containing LSBs of the sample. [Figure A.3-3](#) depicts ADARIO timings.

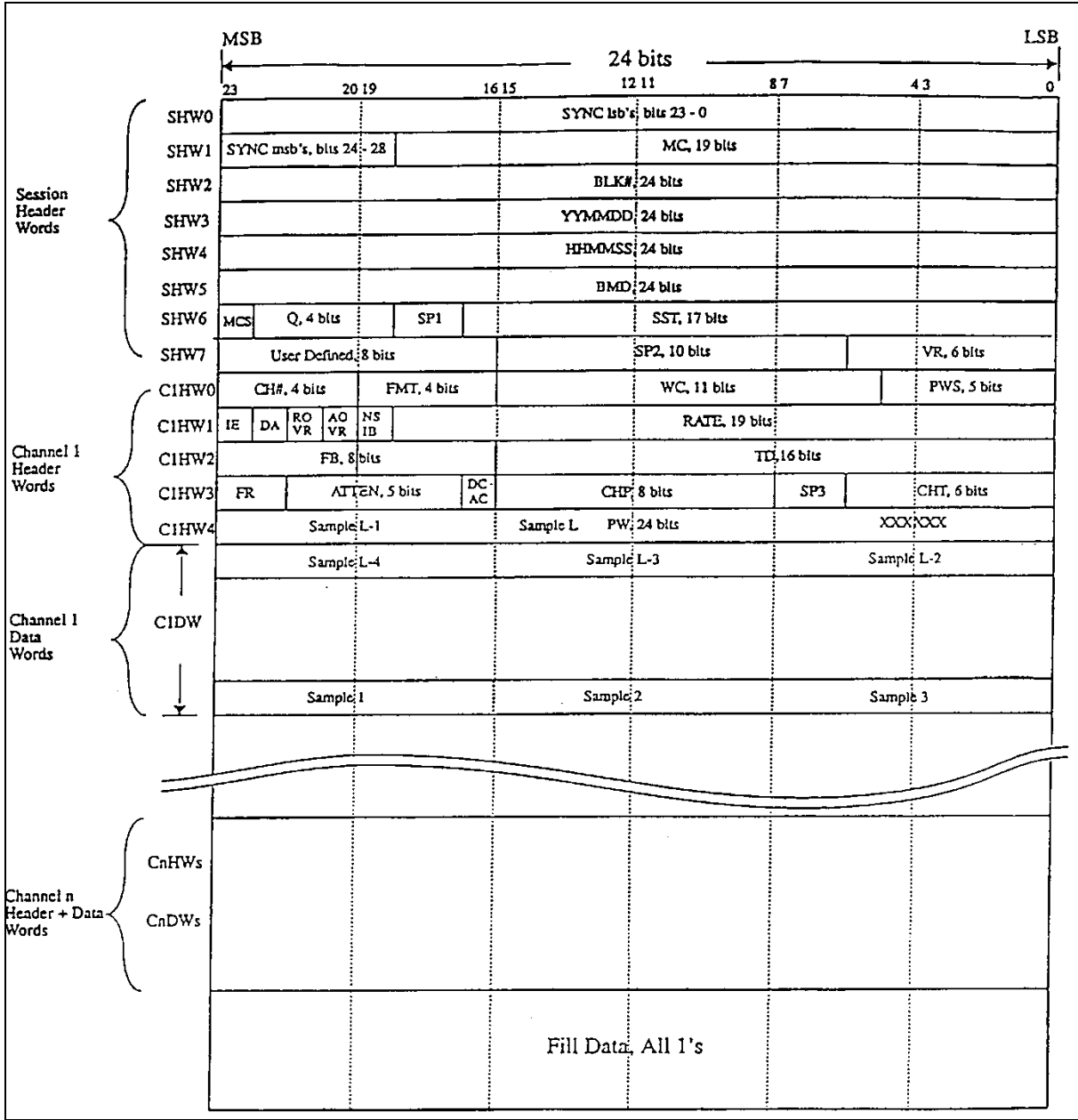

Figure A.3-1. ADARIO Data Format

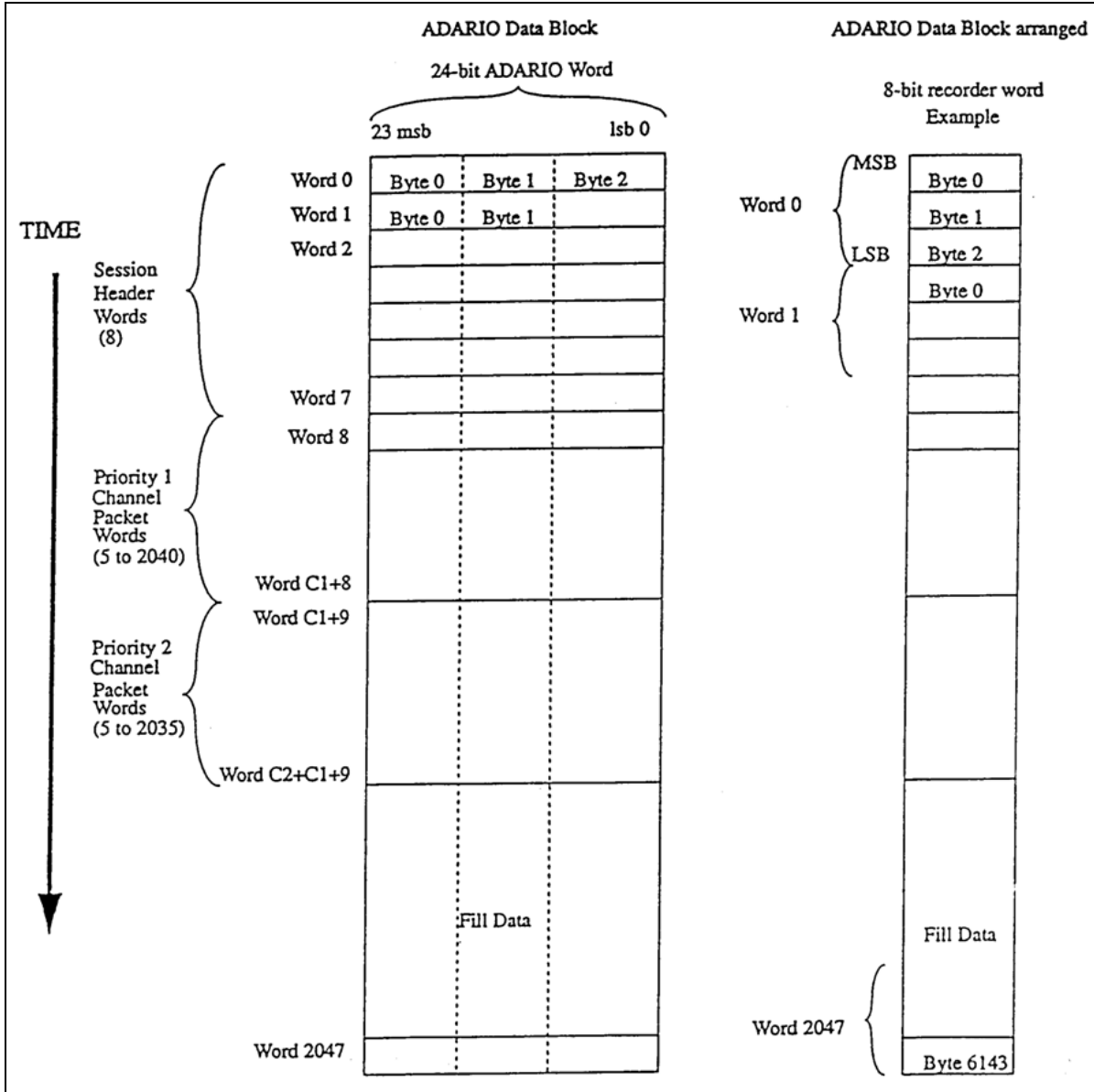

Figure A.3-2. ADARIO Data Blocks

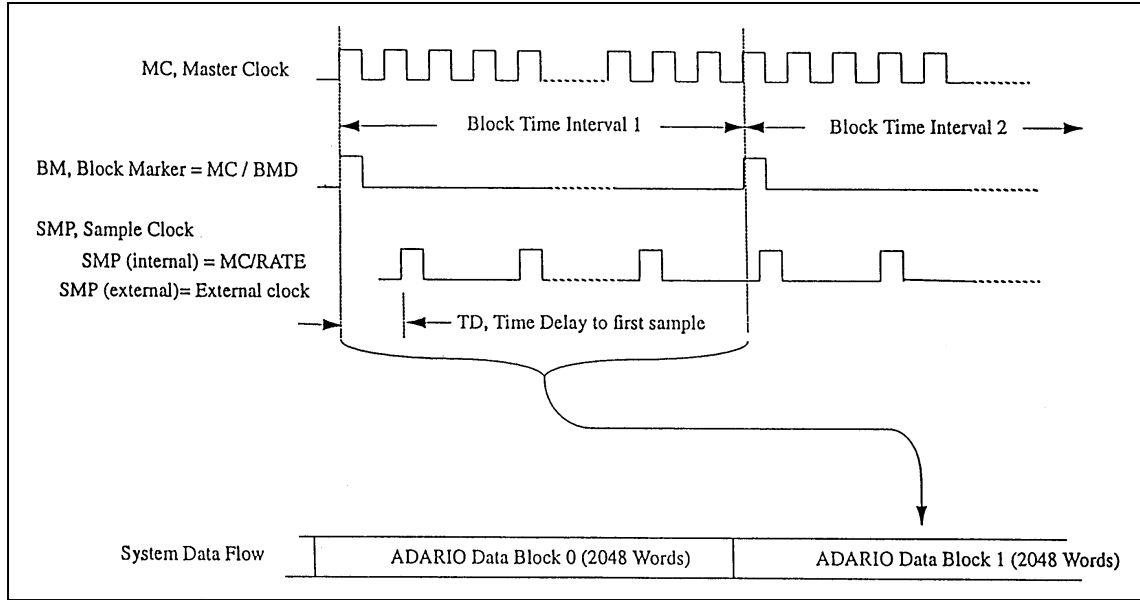

Figure A.3-3. ADARIO Timing

## 2. ADARIO Data Format Field Definitions Summary

### 2.1. Block Length

Block length is defined with 2048 24-bit words, fixed length

### 2.2. Session Header

Session header information is provided by 8 words in a fixed format

SHW0	(bits 23 to 0)	SYNC Field, bits 0-23 of the 29-bit block sync. The LSBs of the block sync are 36E19C and are contained here.
SHW1	(bits 23 to 19)	SYNC Field, bits 24-28 of the 29-bit block sync. The MSBs of the block sync are 01001 and are contained here. The 29-bit block sync is fixed for all ADARIO configurations and chosen for minimal data cross correlation.
	(bits 18 to 0)	MC - Master clock, a 19-bit binary value in units of 250 hertz (Hz). MC is the clock frequency used to derive session and per channel parameters.
SHW2	(bits 23 to 0)	BLK# - ADARIO data block number, a 24-bit binary value. BLK# is to zero at the start of each session and counts up consecutively. Rollover is allowed.
SHW3	(bits 23 to 0)	YYMMDD - Time code field, a binary coded decimal (BCD) representation of the year (YY), month (MM), and day (DD). YYMMDD time code field is updated during the record process once per second.

- SHW4 (bits 23 to 0) HHMMSS - Time code field, a BCD representation of the hour (HH), minute (MM), and second (SS). The HHMMSS Time Code Field is updated during the record process once per second.
- SHW5 (bits 23 to 0) BMD - Block marker divisor, a 24-bit binary value. BMD is established so that the block marker (BM) frequency may be derived from MC by  $BM = MC/BMD$
- SHW6 (bit 23) MCS - Master clock source, a 1-bit flag.
  - 1 = MC was generated internally.
  - 0 = MC was provided from an external source.
- (bits 22 to 19) Q - Number of active channels minus one, a 4-bit binary value. For example, 0 indicates that one channel is active.
- (bits 17 to 18) SP1 - Spare field 1, a 2-bit field. It is set to zero.
- (bits 16 to 0) SST - Session start time, a 17-bit binary value in units of seconds. The integer number of seconds represents the session start time of day in seconds, where midnight starts with zero.
- SHW7 (bits 23 to 16) User defined, an 8-bit field. May be input by the user at any time during a recording session. The interpretation of this bit field is left to the user.
  - (bits 15 to 6) SP2 - Spare field 2, a 10-bit field. It is set to zero.
  - (bits 5 to 0) VR - Version number, a 6-bit binary value. Each update of the ADARIO format will be identified by a unique version number.

2.3. Channel ‘n’ Header

All channel headers contain five 24-bit ADARIO words with the following fixed format. The first logical channel, n=1, has the highest priority and its channel packet starts in the ninth word of the data block. Each active channel is represented by a channel packet that is present in the data block. The logical channel number, n, represents the relative priority of the channel and the order in which it appears in the data block.

- CnHW0 (bits 23 to 20) CH# - Physical channel number, a 4-bit binary value. 0 to 15 represents the physical location of the channel electronics in the ADARIO hardware. The user sees those locations labeled from 1 to 16.
- (bits 19 to 16) FMT - Format code for the channel data word, a 4-bit binary value. The format code is used to define the size of the user data word by means of [Table A.3-1](#).

<b>Table A.3-1. User Data Word Size</b>	
15=24 bits	7=8 bits
14=22 bits	6=7 bits
13=20 bits	5=6 bits
12=18 bits	4=5 bits

11=16 bits	3=4 bits
10=14 bits	2=3 bits
9=12 bits	1=2 bits
8=10 bits	0=1 bit

- (bits 15 to 5) WC - Word count, an 11-bit binary value. WC is the number of full channel data words that should be in the nth channel packet. WC may range from 0 to 2040. A WC greater than the number of actual words in channel packet indicates a data rate overflow, which would occur when a low-priority channel is not provided sufficient space in the fixed length data block as a result of an uncontrolled data rate in a higher priority channel.
- (bits 4 to 0) PWS - Partial word status, a 5-bit binary value. PWS is related to the number of samples in the partial word and may range from 0 to 23. PWS shall be computed as follows:
- If the number of full samples in the partial word equals zero, then PWS = 0.  
If the number of full samples in the partial word does not equal zero, then PWS = Round Up [Unused bits In PW/Channel Sample Size].
- CnHW1 (bit 23) IE - Channel clock source, a 1-bit flag.
- 1 = The channel clock was generated internally.  
0 = The channel clock was provided from an external source.
- (bit 22) DA - Data type, a 1-bit flag.
- 1 = The channel is operated as a digital channel.  
0 = The channel is operated as an analog channel.
- (bit 21) ROVR - Rate overrun in previous block, a 1-bit flag.
- 1 = The nth channel packet in the previous data block experienced an overrun.  
0 = The nth channel packet in the previous data block did not experience an overrun.
- (bit 20) AOVR - Analog A/D overrange in current block a 1-bit flag.
- 1 = The nth channel in the current data block experienced an analog-to-digital conversion overrange condition.  
0 = The nth channel in the current data block did not experience an analog-to-digital conversion overrange condition.
- (bit 19) NSIB - No samples in current block, a 1-bit flag.

1 = TRUE, there are no samples for the nth channel in the current block.

0 = False, there are samples for the nth channel in the current block.

(bits 18 to 0) RATE - Channel sample rate indicator, 19-bit binary value. The interpretation of the rate value depends on the condition of IE, the channel clock source flag.

If IE = 1, then the value of rate is carried by the 16 LSBs of the rate field. Using rate, the frequency of the internal channel clock can be found by internal sample clock =  $(MC/RATE) - 1$ .

If IE = 0, then rate is a 19-bit binary value in units of 250 Hz, which equals the frequency of the external channel clock as provided by the user at the time of the setup.

**NOTE**



The definitions that are marked with an asterisk apply to analog channels and to particular hardware implementations of ADARIO. For the purposes of this standard, these fields are not used.

\*CnWD2 (bits 23 to 16) FB - Filter bandwidth (BW), an 8-bit binary value. The formula for the BW of the anti-aliasing filter used in an analog channel incorporates FB as  $BW = (FB/2) \cdot 10^{3+FR}$

(bits 15 to 0) TD - Time Delay to first sample, a 16-bit binary value. TD is a measure of the time delay from the block marker, BM, to the first sample arriving at the nth channel during the current data block interval. TD is expressed as the number of master clock, MC, periods minus one.

\*CnWD3 (bits 23 to 22) FR - Filter Range, a 2-bit binary value. The formula for the BW of the anti-aliasing filter used in an analog channel incorporates FR as  $BW = (FB/2) \cdot 10^{3+FR}$

(bits 21 to 17) ATTEN - Attenuation, a 5-bit binary value. ATTEN represents the setting of the input attenuator (or gain) on the nth channel at the time that the record was formed 0 = -15dB and 31 = +16dB with intermediate settings expressed in one dB steps.

(bit 16) DCAC - Analog signal coupling, a 1-bit flag.

1 = The channel is operated with dc coupling at the input.

0 = The channel is operated with ac coupling at the input.

(bits 15 to 8) CHP - Channel parameter field, an 8-bit field. The interpretation of the CHP field depends upon the card type with which it is associated, as defined by the CHT field. Each card type established by the CHT field, as part of its definition, shall specify the form

and interpretation of the CHP field. To date, four input card types have been established. The CHP fields are defined as follows:

\* For CHT=0

(bits 15 to 8) remain undefined for the present analog single channel implementation except that the present hardware implementation expects an all zero field. Would be subject to future definition as long as all the zero fill is set aside.

\* For CHT=1

(bits 15 to 8) remain unused for the present digital single channel implementations except that the present hardware implementation expects an all zero field. Would be subject to future definition as long as the all zero fill is set aside.

\* For CHT=2

(bits 15 to 8) remain unused for the present dual-purpose channel implementations except that the present hardware implementation expects an all zero field. Would be subject to future definition as long as the all zero fill is set aside.

For CHT=3

(bits 15 to 12) establish the number of subchannels that are multiplexed into the multichannel data carried by the nth channel.

(bits 11 to 8) identify the subchannel number of the first sample contained in the nth channel packet of the data block.

(bits 7 to 6) SP3 - Spare field 3, a 2-bit field. It is set to zero.

(bits 5 to 0) CHT - Channel type, a 6-bit field. Defines the type of channel through which input data was acquired. Additional channel types to be defined (TBD) by future users and developers.

\* CHT=0 Single channel analog input

\* CHT=1 Single channel digital input

\* CHT=2 Single channel, dual-purpose, analog or digital input

\* CHT=3 Multichannel analog input capable of multiplexing up to 16 analog inputs

\* CHT=4 Single channel digital input, dual channel analog input (stereo)

“L” channel on bits 15 to 8 of the sample word

“R” channel on bits 7 to 0 of the sample word

CHT=5 Single channel, triple-purpose, analog, digital, submux, formatted input



CnWD4	(bits 23 to 0)	PW - Partial word, A 24-bit field. PW contains the last samples of the data block. The most significant bits of word contain the first sample, followed by the next sample in the next most significant bits. The number of samples in the PW is defined in the PWS field. The unused bits are not intentionally set and so contain random data.
Fill	(bits 23 to 0)	Fill - Fill Words consisting of all ones binary, used for fixed rate aggregate. Fill words may be omitted when variable rate aggregate can be accommodated resulting in variable length blocks of up to 2048, 24-bit words.

### 3. Submux Data Format Field Definitions

The details of the submux data format are shown in [Table A.3-2](#) and [Table A.3-3](#) and defined in Section 4. [Figure A.3-4](#) shows a typical primary channel aggregate data content for fixed and variable rate channel. Submux data format is based on the sequential collection of the individual channel data blocks. Each channel data block is the sequential collection of presented input samples in a fixed period of time. This sequential collection results in a variable length, fixed rate, and channel data blocks. To accommodate fixed rate channels, fill is also defined. The aggregate data stream is composed of a block sync timing channel, followed by sequential channel data blocks, if enabled, followed by fill, if required, at fixed block rate.

**Table A.3-2. Submux Data Format**

General Form																								
	15	14	13	12	11	10	9	8	7	6	5	4	3	2	1	0								
HW1	CHN ID					CHT			FMT				ST1	ST2	ST3	ST4								
HW2																								
HW3	I/E	Time Delay or Sample Period																						
Frame Sync																								
HW1	CHN ID = 1F					CHT = 0			Sync 1 = F8C7 hex (full word)															
HW2	Sync 2 = BF1E hex																							
HW3	BRC			Fill										AOE	PCRE	ST3	ST4							
Time Tag																								
HW1	CHN ID = 0 to 30					CHT = 0			MSB Days (BCD)															
HW2	Days LSB		Hours (BCD) LSB					Minutes (BCD) LSB																
HW3	Seconds (BCD) LSB								Fractional Seconds LSB															
Annotation Text																								
HW1	CHN ID = 0 to 30					CHT = 1			FMT = 7				NC	OVR	PE	OE								
HW2	Bit_Count																							
HW3	Block Count																							
DW1	MSB				1 <sup>st</sup> Character				LSB				MSB				2 <sup>nd</sup> Character				LSB			
:																								
DWn	MSB				Last Character				LSB				Undefined if not last											
Digital Serial External Clock																								
Digital Serial External Clock																								
HW1	CHN ID = 0 to 30					CHT = 2			FMT = 0				NSIB	OVR	ST3	ST4								
HW2	Bit_Count = L																							
HW3	I/E=0	Time Delay																						
DW1	DS <sub>1</sub>	DS <sub>2</sub>	DS <sub>3</sub>	DS <sub>4</sub>	DS <sub>5</sub>	DS <sub>6</sub>	DS <sub>7</sub>	DS <sub>8</sub>	DS <sub>9</sub>	DS <sub>1</sub>	DS <sub>1</sub>	DS <sub>1</sub>	DS <sub>1</sub>	DS <sub>1</sub>	DS <sub>1</sub>	DS <sub>1</sub>								
:																								
DWn							DS <sub>L-1</sub>	DS <sub>L</sub>	Undefined if not last															

**Table A.3-3. Submux Data Format (Continuation)**

<b>Digital Serial Internal Clock</b>																
	15	14	13	12	11	10	9	8	7	6	5	4	3	2	1	0
HW1	CHN ID = 0 to 30					CHT = 2			FMT = 0				0	0	ST3	ST4
HW2	BIT_COUNT = L															
HW3	I/E=1	SAMPLE PERIOD														
DW1	DS <sub>1</sub>	DS <sub>2</sub>	DS <sub>3</sub>	DS <sub>4</sub>	DS <sub>5</sub>	DS <sub>6</sub>	DS <sub>7</sub>	DS <sub>8</sub>	CS <sub>1</sub>	CS <sub>2</sub>	CS <sub>3</sub>	CS <sub>4</sub>	CS <sub>5</sub>	CS <sub>6</sub>	CS <sub>7</sub>	CS <sub>8</sub>
DW <sub>n</sub>	DS <sub>L-7</sub>	DS <sub>L-6</sub>	DS <sub>L-5</sub>	DS <sub>L-4</sub>	DS <sub>L-3</sub>	DS <sub>L-2</sub>	DS <sub>L-1</sub>	DS <sub>L</sub>	CS <sub>L-7</sub>	CS <sub>L-6</sub>	CS <sub>L-5</sub>	CS <sub>L-4</sub>	CS <sub>L-3</sub>	CS <sub>L-2</sub>	CS <sub>L-1</sub>	CS <sub>L</sub>
<b>Digital Parallel External Clock</b>																
	15	14	13	12	11	10	9	8	7	6	5	4	3	2	1	0
HW1	CHN ID = 0 to 30					CHT = 3			FMT=0 to 15 (shown =6)				NSIB	OVR	ST3	ST4
HW2	BIT_COUNT = L															
HW3	I/E=0	TIME DELAY														
DW1	MSB					1 <sup>st</sup> sample			MSB				2 <sup>nd</sup> sample		3rd sample	
DW <sub>n</sub>	MSB		Last sample			LSB=bit L			UNDEFINED if not last							
<b>Analog Wide Band</b>																
	15	14	13	12	11	10	9	8	7	6	5	4	3	2	1	0
HW1	CHN ID = 0 to 30					CHT = 4			FMT=0 to 15 (shown =7)				AOR	ST2	ST3	ST4
HW2	BIT_COUNT = L															
HW3	I/E=1	SAMPLE PERIOD														
DW1	MSB					1 <sup>st</sup> sample			MSB				2 <sup>nd</sup> sample			
DW <sub>n</sub>	MSB		Last SAMPLE			LSB=bit L			UNDEFINED if not last							
<b>Analog Stereo Left and Right</b>																
	15	14	13	12	11	10	9	8	7	6	5	4	3	2	1	0
HW1	CHN ID = 0 to 30					CHT = 5			FMT=0 to 15 (shown =7)				LAOR	RAOR	ST3	ST4
HW2	BIT_COUNT = L															
HW3	I/E=1	ENL	ENR	SAMPLE PERIOD												
DW1	MSB					1 <sup>st</sup> sample "L"			MSB				1 <sup>st</sup> sample "R"			
DW <sub>n</sub>	MSB		Last sample			LSB=bit L			UNDEFINED if not last							
<b>Fill</b>																
FW	Fill Word = FFFF hex															

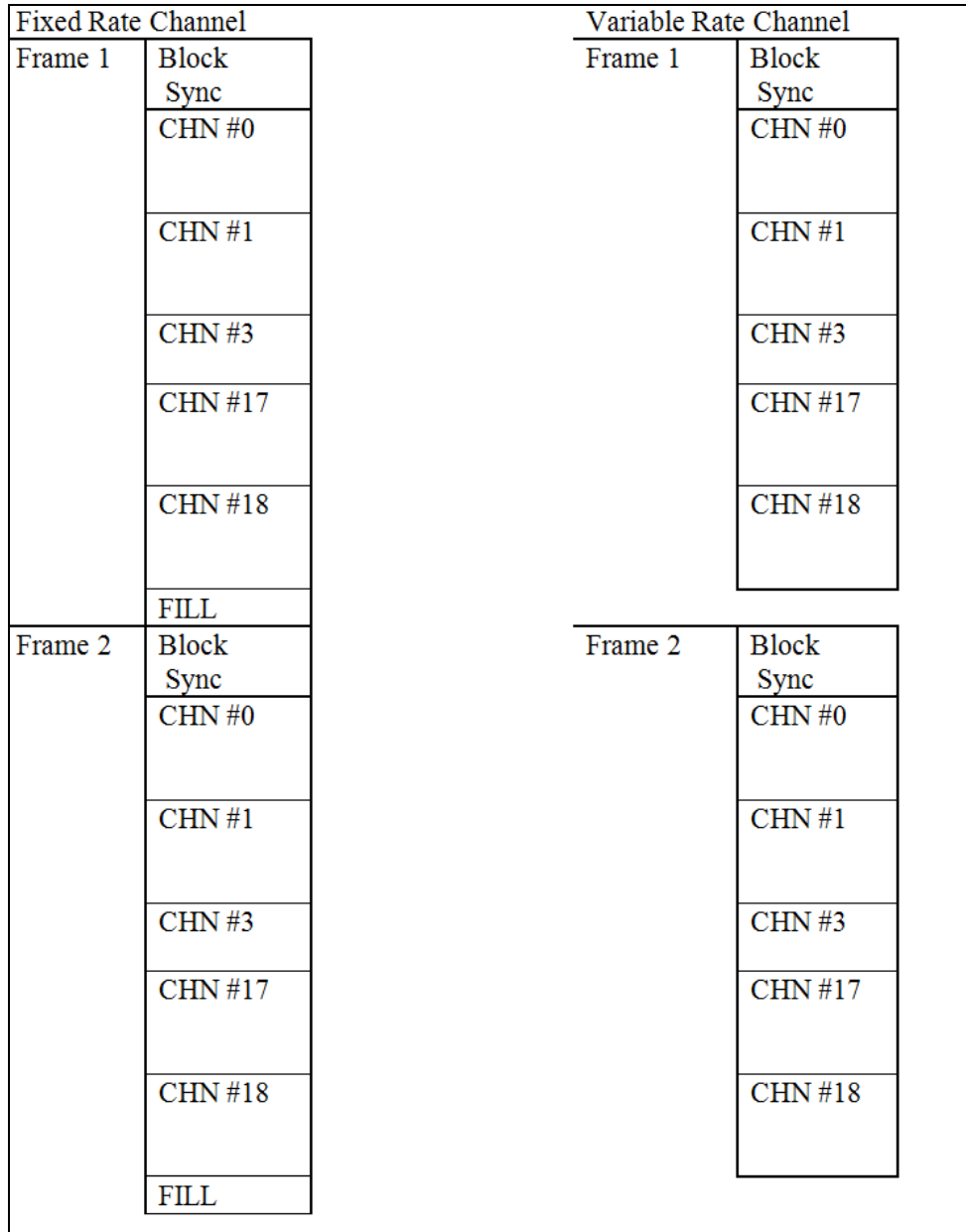

Figure A.3-4. Submux Aggregate Format

The channel data blocks are the sequential collection of input samples bit packed into sequential 16-bit words over the block period of time. The data block is preceded by a three-word header that identifies the source (channel ID) of data, channel type of processing, packing format in the data block, bit count length of the valid data, and the time delay between the first sample and the block period. If data were internally sampled, the sample period is defined with the first sample being coincident with the start of block period. Channel type is used to define specific types of channels that provide timing, annotation, and synchronization functions that may be required by the specific primary channel or may be redundant and not required. Specific implementation of the required channels may provide only the required channels with specific implementation constraints that limit the aggregate rate or the range of any specific field.

The submux format is based on a 16-megahertz (MHz) clock defining all timing. The derived clock is the 16-MHz clock divided in binary steps as defined by  $2^{BRC}$  that defines all timing and internal sampling. Block period is 20,160 derived clock periods which limits the submux aggregate to 256 megabits per second (Mbps), limits the maximum block rate to 793.65 blocks per second, and in conjunction with a 16-bit bit count field, limits the subchannel maximum data rate to 52 Mbps.

#### 4. SubMux Data Format Field Definitions Summary

##### 4.1. Frame length

Frame length is variable or fixed with fill. Minimum is 3-word block sync plus one channel block, maximum is 20,160x16-bit words.

##### 4.2. Block length

This field is variable from 3x16-bit words to 4099x16-bit words per channel data block. The length is specified by  $CHT > 0$  and integer of  $(Bit\_Count + 15/16)$  and may be limited by implementation.

##### 4.3. Block sync

This is defined by Channel ID = 31, 3-word block, 2-word sync. The channel defines a period of 20,160 derived clocks.

##### 4.4. General form

All channel data blocks contain this information in the 3-word header.

HW1	(bits 15 to 11)	CHN ID - Channel ID number. From 0 to 30 represents normal channel of any type. CHN ID = 31 reserved for Block Sync.
	(bits 10 to 8)	CHT - Channel type. From 0 to 7 defines type of processing performed on the data and the format of header word fields.
		CHT = 0 Timing channel, block sync or time tag, 3-word only
		CHT = 1 Annotation text or block count, variable length
		CHT = 2 Digital serial external or internal clock, variable
		CHT = 3 Digital parallel external clock, variable
		CHT = 4 Analog wide band, variable
		CHT = 5 Analog stereo, variable
		CHT = 6 TBD by future implementation
		CHT = 7 TBD

	Variable length	General form with variable data block length
HW1	(bits 15 to 11)	CHN ID - Channel ID number. From 0 to 30 represents normal channel of any type.
	(bits 10 to 8)	CHT - Channel type. From 1 to 7 defines type of processing performed on the data and the format of header word fields.

	(bits 7 to 4)	FMT - Format, defines the number of bits minus one in each sample. Data block sample size (bits) = (FMT+1). Range 0 to 15, binary format.
	(bits 3 to 0)	ST1 to ST4, status bits, define dynamic conditions within this block period such as over range.
HW2	(bits 15 to 0)	Bit_Count defines the number of valid data bits in the data block starting with the most significant bit of the first data word DW1. Variable word length of the data block is the Integer of $\{(Bit\_Count + 15)/16\}$ . Range 0 to 65,535, binary format.
HW3	(bit 15)	I/E - Internal/external clock
	(bits 15 to 0)	Depends on CHT field, defines block count, time delay, or sample period.

#### 4.5. Block Sync

The following defines the start of channel data blocks and start of block period that lasts for 20,160 derived clocks.

HW1	(bits 15 to 0)	SYNC 1 = F8C7 hex, defines the first sync word.
HW2	(bits 15 to 0)	SYNC 2 = BF1E hex, defines the second sync word.
HW3	(bits 15 to 13)	BRC - Block rate clock, defines the binary divisor for the 16 MHz system clock. Derived CLK = 16 MHz / $2^{BRC}$ MHz. Block rate = Derived CLK / 20,160 Hz. Period = 1 / Derived CLK.
	(bit 12)	FILL - indicates if the primary channel requires fill for constant rate.
	(bits 11 to 4)	TBD
	(bit 3)	AOE - Aggregate overrun error if set indicates that the aggregate of the enabled channels exceeds the submux aggregate (data truncated to 20,160 words between sync).
	(bit 2)	PCRE - Primary channel rate error if set indicates that primary channel is unable to maintain the aggregate rate of the submux. Excess blocks are truncated.
	(bits 1 to 0)	ST3, ST4, Status reserved.

#### 4.6. Time Tag

The following defines the time tag channel for time stamping the frame.

HW1	(bits 15 to 11)	CHN ID - Channel ID number. From 0 to 30 represents normal channel.
	(bits 10 to 8)	CHT = 0, Channel Type = 0, Time Tag IRIG Time code processing and 3-word format.

HW	(bits 7 to 0)	DAYS - Most significant 8 bits of Time Code Days field. BCD format.
	(bits 15 to 14)	DAYS - Least significant 2 bits of Time Code Days field. BCD format.
	(bits 13 to 8)	HOURS - Time code hours, 6-bit field. BCD format.
HW	(bits 7 to 0)	MINUTES - Time code minutes, 7-bit field. BCD format.
	(bits 15 to 8)	SECONDS - Time code seconds, 7-bit field. BCD format.
	(bits 7 to 0)	FRACTIONAL SECONDS - Time code fractional seconds, 8-bit field. BCD format.

#### 4.7. Annotation Text

The following defines block count and annotation text that pertains to the subchannels at this time.

HW1	(bits 15 to 11)	CHN ID - Channel ID number. From 0 to 30 represents normal channel.
	(bits 10 to 8)	CHT = 1, Channel Type = 1, Block Count and Annotation Text if any.
	(bits 7 to 4)	FMT = 7, Format = 7, defines 8 bit ASCII character in text.
	(bit 3)	NC - No Characters (Bit_Count = 0) Block count only.
	(bits 2 to 0)	OVR, PE, OE - Overrun Parity and async framing error.
HW	(bits 15 to 0)	Bit_Count defines the number of valid data bits in the data block starting with the MSB of the first data word DW1. Variable word length of the data block is the Integer of $\{(Bit\_Count + 15)/16\}$ . Range 0 to 65,535, binary format.
HW	(bits 15 to 0)	Block_Count sequential block numbering with rollover at maximum. Range 0 to 65,535, binary format.
DW1	(bits 15 to 8)	1st character - first text character.
DW	(bits 8 or 0)	Last character - LSB is defined by the bit count.

#### 4.8. Digital Serial External Clock

Defines digital serial data such as PCM externally clocked.

HW1	(bits 15 to 11)	CHN ID - Channel ID number. From 0 to 30 represents normal channel.
	(bits 10 to 8)	CHT = 2, Channel Type = 2, digital serial or data and clock over sampled data.
	(bits 7 to 4)	FMT = 0 Format = 0, defines 1-bit data samples.
	(bit 3)	NSIB - No Samples In Block (Bit_Count=0) header only.

	(bit 2)	OVR - Overrun indicates that input is clocking at faster than specified rate. Data is truncated at specified bit rate (Bit Count per Block).
HW	(bits 15 to 0)	Bit_Count - Defines the number of valid data bits in the data block starting with the most significant bit of the first data word DW1. Variable word length of the data block is the Integer of $\{(Bit\_Count + 15)/16\}$ . Range 0 to 65,535, binary format. Limited by set maximum rate.
HW	(bit 15)	I/E = 0 - Internal/external clock flag indicates that external clocking was used with relative phasing to block as specified in next field.
	(bits 14 to 0)	Time Delay - provides the measure of time between start of block period and the first external clock in derived clock periods. Range 0 to 20,160, binary format.
DW1	(bit 15)	DS <sub>1</sub> - first data sample at the first clock time in the block.
DW <sub>n</sub>	(bit L)	DS <sub>L</sub> - last data sample in this block period.

#### 4.9. Digital Serial Internal Clock

This information defines digital serial data low rate (> 2 samples per block period) internally oversampled.

HW1	(bits 15 to 11)	CHN ID - Channel ID number. From 0 to 30 represents normal channel.
	(bits 10 to 8)	CHT = 2 - Channel type = 2, Digital serial or data and clock over sampled data.
	(bits 7 to 4)	FMT = 0 - Format = 0, defines 1-bits data samples.
	(bits 3 to 0)	0, reserved.
HW2	(bits 15 to 0)	Bit_Count - Defines the number of valid data bits in the data block starting with the most significant bit of the first data word DW1. Variable word length of the data block is the Integer of $\{(Bit\_Count + 15)/16\}$ . Range 0 to 65,535, binary format. Limited by set maximum rate.
HW3	(bit 15)	I/E = 1 - Internal sampling flag indicates that internal sampling was used as specified in next field.
	(bits 14 to 9)	TBD
	(bits 8 to 0)	SAMPLE PERIOD - Defines the period of the over-sampling clock that samples data and clock, in derived clock periods. Range 0 to 4 mega samples per second, binary format.
DW1	(bit 15)	DS <sub>1</sub> - first data sample at block time.
	(bit 7)	CS <sub>1</sub> - first clock sample at block time.



DW <sub>n</sub>	(bit 8)	DS <sub>L</sub> - last data sample in this block period.
	(bit 0)	CS <sub>L</sub> - last clock sample in this block period.

#### 4.10. Digital Parallel External Clock

This information defines digital data, including serial externally clocked.

HW1	(bits 15 to 11)	CHN ID - Channel ID number. From 0 to 30 represents normal channel.
	(bits 10 to 8)	CHT = 3 -Channel type = 3, Digital parallel or serial data.
	(bits 7 to 4)	FMT - Format defines the number of bits minus one in each sample. Data block sample size (bits) = (FMT+1). Range 0 to 15, binary format.
	(bit 3)	NSIB - No Samples In Block (Bit_Count = 0) Header only.
	(bit 2)	OVR - Overrun indicates that input is clocking at faster than specified rate. Data is truncated at specified bit rate (Bit Count per Block).
HW2	(bits 15 to 0)	Bit_Count defines the number of valid data bits in the data block starting with the most significant bit of the first data word DW1. Variable word length of the data block is the Integer of ((Bit_Count + 15)/16). Range 0 to 65,535, binary format. Limited by set maximum rate.
HW3	(bit 15)	I/E = 0 - Internal/external clock flag indicates that external clocking was used with relative phasing to block as specified in next field.
	(bits 14 to 0)	Time delay provides the measure of time between start of block period and the first external clock in derived clock periods. Range 0 to 20,160, binary format.
DW1	(bit 15)	DS <sub>1</sub> - MSB of the first data sample at the first clock time in the block.
DW <sub>n</sub>	(bit L)	DS <sub>L</sub> - LSB of the last data sample in this block period.

#### 4.11. Analog Wide Band

The following defines analog wide band data using a sampling A/D and internal block synchronous clock.

HW1	(bits 15 to 11)	CHN ID - Channel ID number. From 0 to 30 represents normal channel.
	(bits 10 to 8)	CHT = 4 - Channel Type = 4, analog wide band sampled data.

	(bits 7 to 4)	FMT - Format, defines the number of bits minus one in each sample. Data block Sample Size (bits) = (FMT+1). Range 0 to 15, binary format. Limited by the A/D resolution.
	(bit 3)	AOR - Analog overrange (A/D 4-MSB = F).
	(bits 2 to 0)	ST2 to ST4, reserved status
HW2	(bits 15 to 0)	Bit_Count defines the number of valid data bits in the data block starting with the MSB of the first data word DW1. Variable word length of the data block is the Integer of ((Bit_Count + 15)/16). Range 0 to 65,535, binary format. Limited by set maximum rate.
HW3	(bit 15)	I/E = 1 - Internal Sampling flag indicates that internal sampling was used as specified in next field.
	(bits 14 to 12)	TBD
	(bits 11 to 0)	Sample period defines the period of the over-sampling clock that samples data and clock, in derived clock periods. Range 0 to 4m samples per second, binary format.
DW1	(bit 15)	DS <sub>1</sub> - MSB of the first data sample at the first clock time in the block.
DW <sub>n</sub>	(bit L)	DS <sub>L</sub> - LSB of the last data sample in this block period.

#### 4.12. Analog Stereo “L” & “R”

The following defines analog stereo data using a sigma-delta A/D and internal block synchronous clock with tracking Finite Impulse Response filter.

HW1	(bits 15 to 11)	CHN ID -Channel ID number. From 0 to 30 represents normal channel.
	(bits 10 to 8)	CHT = 5, Channel Type = 5, Analog stereo voice band data.
	(bits 7 to 4)	FMT, Format defines the number of bits minus one in each sample. Data block sample size (bits) = (FMT+1). Range 0 to 15, binary format. Limited by the A/D resolution.
	(bit 3)	LAOR, left subchannel over range.
	(bit 2)	RAOR, right subchannel over range.
	(bits 1 to 0)	ST2 to ST4, reserved status.
HW2	(bits 15 to 0)	Bit_Count defines the number of valid data bits in the data block starting with the MSB of the first data word DW1. Variable word length of the data block is the Integer of {(Bit_Count + 15)/16}. Range 0 to 65,535, binary format. Limited by set maximum rate.
HW3	(bit 15)	I/E = 1 - Internal sampling flag indicates that internal sampling was used as specified in next field.
	(bit 14)	ENL - Enable left subchannel.

	(bit 13)	ENR - Enable right subchannel.
	(bit 12)	TBD
	(bits 11 to 0)	Sample period defines the period of the over-sampling clock that samples data and clock, in derived clock periods. Range 3.76 to 40K samples per second, binary format.
DW1	(bit 15)	DS <sub>1</sub> - MSB of the first data sample left subchannel if enabled.
	(bit 15)	DS <sub>1</sub> - MSB of the first data sample right subchannel if enabled, else second sample (FMT-1).
DW <sub>n</sub>	(bit L)	DS <sub>L</sub> , LSB of the last data sample in this block period.

4.13. Fill

This term defines a fill word that can be inserted at the end of all channel data blocks if required by the constant rate primary channel.

Fwx (bits 15 to 0) FILL, defined as FFFF hex word.

\*\*\*\* END OF ANNEX A.3 \*\*\*\*

## ANNEX A-4

### Asynchronous Recorder Multiplexer Output Re-Constructor (ARMOR)

<b>Acronyms</b> .....		<b>A.4-iii</b>
<b>1. General</b> .....		<b>A.4-1</b>
1.1. Setup on Tape .....		A.4-1
<b>2. Setup Organization</b> .....		<b>A.4-1</b>
2.1. Header Section .....		A.4-2
2.2. Channel Section .....		A.4-2
2.3. Trailer Section.....		A.4-10
2.4. Saved Scanlist Structure .....		A.4-10
2.5. Creating a Setup Block .....		A.4-10

### List of Tables

Table A.4-1.	ARMOR Setup Preamble.....	A.4-1
Table A.4-2.	Setup Organization.....	A.4-1
Table A.4-3.	Header Section Format .....	A.4-2
Table A.4-4.	Channel Entry Lengths .....	A.4-3
Table A.4-5.	PCM Input Channels.....	A.4-3
Table A.4-6.	PCM Output Channels .....	A.4-4
Table A.4-7.	Analog Input and Output Channels.....	A.4-4
Table A.4-8.	Parallel Input Channels .....	A.4-5
Table A.4-9.	Parallel Output Channels .....	A.4-5
Table A.4-10.	Time Code Input Channels .....	A.4-6
Table A.4-11.	Time Code Output Channels.....	A.4-7
Table A.4-12.	Voice Input Channel .....	A.4-8
Table A.4-13.	Voice Output Channels .....	A.4-9
Table A.4-14.	Bit Sync Input Channels .....	A.4-9
Table A.4-15.	Trailer Section Format .....	A.4-10

This page intentionally left blank.

## Acronyms

ARMOR	Asynchronous Recorder Multiplexor Output Re-constructor
ASCII	American Standard Code for Information Interchange
HF	high frequency
LF	low frequency
LSB	least significant bit
Mb	megabit
NRZ-L	non-return-to-zero-level
PCM	pulse code modulation

This page intentionally left blank.



## ANNEX A.4

### Asynchronous Recorder Multiplexer Output Re-Constructor

#### 1. General

This standard defines the recommended multiplexer format for single-channel data recording on small-format (1/2 in.) media. This format is recognized as the Asynchronous Recorder Multiplexer Output Re-Constructor (ARMOR). This format is software-reconfigurable for each data acquisition or reproduction. The ARMOR format configuration information is stored in a data structure called a “setup” that contains all the information necessary to define a particular record or play configuration. This annex describes the format and content of the ARMOR setup.

##### 1.1. Setup on Tape

When the ARMOR setup is written to tape, it is preceded by a preamble with a unique setup sync pattern that allows the identification of the setup. Three duplicate setup records, each with its own preamble, are written at the beginning of each recording. The format of the preamble is defined in [Table A.4-1](#).

<b>Field</b>	<b>Length</b>	<b>Description</b>
Setup sync	4 tape blocks	The sync pattern consists of two bytes. The high byte is 0XE7; the low byte is 0X3D. The sync pattern is written high byte first. For the DCRSI, a tape block is a single scan (4356 bytes). For the VLDS, a tape block is a principle block (65,536 bytes).
End of sync	3 bytes	The three bytes immediately following the sync pattern are: 0X45, 0X4F, 0X53 (American Standard Code for Information Interchange [ASCII] “E”, “O”, “S” for “End of Sync”).

#### 2. Setup Organization

An ARMOR setup is divided into three sections: the header section, the channel section, and the trailer section. The overall organization of a setup is summarized in [Table A.4-2](#).

<b>Content</b>	<b>Number of Bytes</b>
Header section	70
Channel 1 information	51 - 61
Channel 2 information	51 - 61
“ “	“
“ “	“

Trailer section	0 - 44 + saved scanlist size
-----------------	------------------------------

## 2.1. Header Section

The header section is the first 70 bytes of a setup. It contains information about the setup as a whole, including clock parameters, frame parameters, and the numbers of input and output channels (see [Table A.4-3](#)).

 <b>NOTE</b>	In Tables L-3 through L-12, fields noted with an asterisk (*) require user input per Section <a href="#">2.5</a> .
---	--

<b>Table A.4-3. Header Section Format</b>			
Field	Bytes	Format	Description
*Setup Length	2	Binary	Total bytes in setup, including this field
Software Version	12	ASCII	Version of the ARMOR setup and control software that wrote the setup
Pre-scalers	1	Binary	The bottom four bits contain the bit rate clock pre-scaler; the top four bits contain the pacer clock pre-scaler.
Reserved	26	N/A	N/A
*Setup Keys (Bit 0)	1	Binary	If bit 0 (least significant bit [LSB]) set, setup contains setup description in trailer.
*Setup Keys (Bits 1, 2, & 3)			If bit 1 set, setup contains checksum in trailer. If bit 2 set, setup is scan-aligned. If bit 3 set, then a scan list is saved.
Pacer Divider	2	Binary	Pacer divider value
Bit Rate	4	Binary	Aggregate bit rate for all enabled channels
BRC Divider	2	Binary	Bit rate clock divider value
Master Oscillator	4	Binary	Frequency of the master oscillator in bits per second
Bytes Overhead	4	Binary	Total sync bytes plus filler bytes per frame
Pacer	4	Binary	Frequency of the pacer clock in cycles per second
Frame Rate	4	Binary	Number of frames per second
*Input Count	2	Binary	Number of input channels in setup
Output Count	2	Binary	Number of output channels in setup

## 2.2. Channel Section

The channel section contains one channel entry for every channel in the multiplexer chassis configuration, including those channels that are not enabled or recorded. The content and length of the channel information vary depending on the channel type. The lengths of the channel entries for each channel type are presented in [Table A.4-4](#), [Table A.4-5](#) through [Table A.4-15](#) describe the channel entry fields for each module type. Links to the tables are provided below.

[Table A.4-4. Channel Entry Lengths](#)

[Table A.4-5. PCM Input Channels](#)

[Table A.4-6. PCM Output Channels](#)

[Table A.4-7. Analog Input and Output Channels](#)

[Table A.4-8. Parallel Input Channels](#)

[Table A.4-9. Parallel Output Channels](#)

[Table A.4-10. Time Code Input Channels](#)

[Table A.4-11. Time Code Output Channels](#)

[Table A.4-12. Voice Input Channel](#)

[Table A.4-13. Voice Output Channels](#)

[Table A.4-14. Bit Sync Input Channels](#)

[Table A.4-15. Trailer Section Format](#)

<b>Table A.4-4. Channel Entry Lengths</b>	
<b>Channel Type</b>	<b>Bytes</b>
PCM input and output	51
Analog input and output	53
Parallel input	53
Parallel output	56
Timecode input and output	61
Voice input and output	61
Bit sync input	61

<b>Table A.4-5. PCM Input Channels</b>			
<b>Field</b>	<b>Bytes</b>	<b>Format</b>	<b>Description</b>
*Channel Type	2	Binary	1 = 8 bit PCM input 8 = 20-megabit (Mb) PCM input
Mapped Channel	2	Binary	Index of the channel to which this channel is mapped. If the channel is not mapped, the index is -1.
*Enabled	1	ASCII	If enabled, the channel is recorded (“Y” or “N”)
Actual Rate	4	Binary	Actual word rate in words per second
Words Per Frame	4	Binary	Number of words per frame
Input Modes	1	Binary	If bit 0 (LSB) set, source B data; Else source A. If bit 1 set, NRZ-L; else bi-phase-level. If bit 2 set, 0 degree clock; else 90 degree clock.
Reserved	3	N/A	N/A
Bits Per Word	2	Binary	16 bits
Bits Preceding	4	Binary	Number of bits in the frame that must precede this channel
*Channel Number	2	Binary	Channel on module (0-3)
*Module ID	1	Binary	Module ID = HEX 11
Reserved	1	N/A	N/A
*Requested Rate	4	Binary	Requested bits per second (integer)
Description	20	ASCII	Channel description

<b>Table A.4-6. PCM Output Channels</b>			
<b>Field</b>	<b>Bytes</b>	<b>Format</b>	<b>Description</b>
Channel Type	2	Binary	2 = 8 Mb PCM output 9 = 20 Mb PCM output
Mapped Channel	2	Binary	Index of the channel to which this channel is mapped. If the channel is not mapped, the index is -1.
Enabled	1	ASCII	If enabled, the channel is recorded (“Y” or “N”)
Actual Rate	4	Binary	Actual word rate in words per second
Words Per Frame	4	Binary	Number of words per frame
Output Modes	1	Binary	If bit 0 (LSB) set, burst mode. If bit 1 set, bi-phase; else NRZ-L.
Reserved	3	N/A	N/A
Bits Per Word	2	Binary	Number of bits per word
Bits Preceding	4	Binary	Number of bits in the frame that must precede this channel
Channel Number	2	Binary	Channel on module (0-3)
Module ID	1	Binary	Module ID = HEX 21
Reserved	1	N/A	N/A
Requested Rate	4	Binary	Requested bits per second
Description	20	ASCII	Channel description

<b>Table A.4-7. Analog Input and Output Channels</b>			
<b>Field</b>	<b>Bytes</b>	<b>Format</b>	<b>Description</b>
*Channel Type	2	Binary	5 = LF analog input 6 = HF analog input 7 = analog output
Mapped Channel	2	Binary	Index of the channel to which this channel is mapped. If the channel is not mapped, the index is -1.
*Enabled	1	ASCII	If enabled, the channel is recorded (“Y” or “N”).
Actual Rate	4	Binary	Actual sample rate in samples per second
Samples Per Frame	4	Binary	Number of samples per frame
Filter Number	1	Binary	0 = filter 1 1 = filter 2 2 = filter 3 3 = filter 4
Reserved	3	N/A	N/A
*Bits Per Sample	2	Binary	Number of bits per sample (8 or 12)
Reserved	4	N/A	N/A

<b>Table A.4-7. Analog Input and Output Channels</b>			
<b>Field</b>	<b>Bytes</b>	<b>Format</b>	<b>Description</b>
*Channel Number	2	Binary	Channel on module (0-3)
*Module ID	1	Binary	Module ID = 34 HEX (LF) or 33 HEX (HF)
Reserved	1	N/A	N/A
*Requested Rate	4	Binary	Requested samples per second
Reserved	2	N/A	N/A
Description	20	ASCII	Channel description

<b>Table A.4-8. Parallel Input Channels</b>			
<b>Field</b>	<b>Bytes</b>	<b>Format</b>	<b>Description</b>
*Channel Type	2	Binary	13 = new parallel input
Mapped Channel	2	Binary	Index of the channel to which this channel is mapped. If the channel is not mapped, the index is -1.
*Enabled	1	ASCII	If enabled, the channel is recorded (“Y” or “N”).
Actual Rate	4	Binary	Actual words per second
Words Per Frame	4	Binary	Number of words per frame
Reserved	4	N/A	N/A
Bits Per Word	2	Binary	Number of bits per word
Words Preceding	4	Binary	Number of words in the frame that must precede this channel
*Channel Number	2	Binary	Channel on module (0-3)
*Module ID	1	Binary	Module ID = HEX 92
Reserved	1	N/A	N/A
*Requested Rate	4	Binary	Requested words per second
Input Mode	1	Binary	0 = four 8-bit channels 1 = one 16-bit, two 8-bit (currently unavailable) 2 = two 16-bit (currently unavailable) 3 = one 32-bit (currently unavailable) 4 = one 24-bit, one 8-bit (currently unavailable)
Reserved	1	N/A	N/A
Description	20	ASCII	Channel description

<b>Table A.4-9. Parallel Output Channels</b>			
<b>Field</b>	<b>Bytes</b>	<b>Format</b>	<b>Description</b>
Channel Type	2	Binary	14 = new parallel output

<b>Table A.4-9. Parallel Output Channels</b>			
<b>Field</b>	<b>Bytes</b>	<b>Format</b>	<b>Description</b>
Mapped Channel	2	Binary	Index of the channel to which this channel is mapped. If the channel is not mapped, the index is -1.
Enabled	1	ASCII	If enabled, the channel is recorded (“Y” or “N”).
Actual Rate	4	Binary	Actual word rate in words per second
Words Per Frame	4	Binary	Number of words per frame
Reserved	4	N/A	N/A
Bits Per Word	2	Binary	Number of bits per word
Words Preceding	4	Binary	Number of words in the frame that must precede this channel
Channel Number	2	Binary	Channel on module (0-3)
Module ID	1	Binary	Module ID = HEX A2
Reserved	1	N/A	N/A
Requested Rate	4	Binary	Requested words per second
Output Mode	1	Binary	0 = four 8-bit channels 1 = one 16-bit, two 8-bit 2 = two 16-bit channels 3 = one 32-bit channel 4 = one 24-bit, ONE 8-bit 7 = two 8-bit DCRSI mode
Reconstruct Mode	1	Binary	0 = data is from module other than parallel input 1 = data is from parallel input Valid only for output mode.
DCRSI Output	1	Binary	0 = header and data 1 = header only 3 = data valid only for output mode 7.
Burst Select	1	Binary	0 = constant 1 = burst
Handshake Select	1	Binary	0 = disable handshaking 1 = enable handshaking
Description	20	ASCII	Channel description

<b>Table A.4-10. Time Code Input Channels</b>			
<b>Field</b>	<b>Bytes</b>	<b>Format</b>	<b>Description</b>
*Channel Type	2	Binary	Time code must appear as a group of three channels, even though the user interface only displays a single channel. The respective types are 15, 19, and 20.

**Table A.4-10. Time Code Input Channels**

Field	Bytes	Format	Description
Mapped Channel	2	Binary	Index of the channel to which this channel is mapped. If the channel is not mapped, the index is -1.
*Enabled	1	ASCII	“Y” or “N”
Actual Rate	4	Binary	1
Samples Per Frame	4	Binary	1
Reserved	4	N/A	N/A
*Bits Per Word	2	Binary	24 for channel type 15 24 for channel type 19 16 for channel type 20
Reserved	4	N/A	N/A
*Channel Number	2	Binary	0 for channel type 15 1 for channel type 19 2 for channel type 20
*Module ID	1	Binary	Module ID = HEX B1
Reserved	1	N/A	N/A
*Request Sample Rate	4	Binary	1
*Bits Per Sample	2	Binary	24 for channel type 15 24 for channel type 19 16 for channel type 20
Description	20	ASCII	Channel description
Reserved	4	N/A	N/A
TCI Mode	1	Binary	0 = generate time 1 = use external IRIG source
Reserved	3	N/A	N/A

**Table A.4-11. Time Code Output Channels**

Field	Bytes	Format	Description
Channel Type	2	Binary	Time code must appear as a group of three channels, even though the user interface only displays a single channel. The respective types are 17, 21, and 22.
Mapped Channel	2	Binary	Index of the channel to which this channel is mapped. If the channel is not mapped, the index is -1.
Enabled	1	ASCII	“Y” - enabled, or “N” - disabled
Actual Rate	4	Binary	1
Samples Per Frame	4	Binary	1
Reserved	4	N/A	N/A

<b>Table A.4-11. Time Code Output Channels</b>			
<b>Field</b>	<b>Bytes</b>	<b>Format</b>	<b>Description</b>
Bits Per Word	2	Binary	24 for channel type 17 24 for channel type 21 16 for channel type 22
Reserved	4	N/A	N/A
Channel Number	2	Binary	0 for channel type 17 1 for channel type 21 2 for channel type 22
Module ID	1	Binary	Module ID = HEX B1
Reserved	1	N/A	N/A
Requested Sample Rate	4	Binary	1
Bits Per Sample	2	Binary	24 for channel type 17 24 for channel type 21 16 for channel type 22
Description	20	ASCII	Channel description
Reserved	4	N/A	N/A
TCO Mode	1	Binary	0 - generate time 1 - use time from recorded tape
Reserved	3	N/A	N/A

<b>Table A.4-12. Voice Input Channel</b>			
<b>Field</b>	<b>Bytes</b>	<b>Format</b>	<b>Description</b>
*Channel Type	2	Binary	16
Mapped Channel	2	Binary	Index of the channel to which this channel is mapped. If the channel is not mapped, the index is -1.
*Enabled	1	ASCII	“Y” - enabled, or “N” - disabled
Actual Rate	4	Binary	Actual sample rate in samples per second
Samples Per Frame	4	Binary	Number of samples per frame
Reserved	4	N/A	N/A
*Bits Per Word	2	Binary	8
Reserved	4	N/A	N/A
*Channel Number	2	Binary	3
*Module ID	1	Binary	Module ID = HEX B1
Reserved	1	N/A	N/A
*Requested Sample Rate	4	Binary	2K, 5K, 10K, 20K, 50K, OR 100K
*Bits Per Sample	2	Binary	8
Description	20	ASCII	Channel Description
Reserved	1	N/A	N/A



<b>Table A.4-12. Voice Input Channel</b>			
<b>Field</b>	<b>Bytes</b>	<b>Format</b>	<b>Description</b>
Voltage Gain	2	Binary	0 - gain of 1 1 - gain of 2 2 - gain of 4 3 - gain of 8
Reserved	5	N/A	N/A

<b>Table A.4-13. Voice Output Channels</b>			
<b>Field</b>	<b>Bytes</b>	<b>Format</b>	<b>Description</b>
Channel Type	2	Binary	18
Mapped Channel	2	Binary	Index of the channel to which this channel is mapped. If the channel is not mapped, the index is -1.
Enabled	1	ASCII	“Y” - enabled, or “N” - disabled
Actual Rate	4	Binary	Actual sample rate in samples per second
Samples Per Frame	4	Binary	Number of samples per frame
Reserved	4	N/A	N/A
Bits Per Word	2	Binary	8
Reserved	4	N/A	N/A
Channel Number	2	Binary	3
Module ID	1	Binary	Module ID = HEX B1
Reserved	1	N/A	N/A
Request Sample Rate	4	Binary	Number of samples per second
Bits Per Sample	2	Binary	8
Description	20	ASCII	Channel description
Reserved	8	N/A	N/A

<b>Table A.4-14. Bit Sync Input Channels</b>			
<b>Field</b>	<b>Bytes</b>	<b>Format</b>	<b>Description</b>
Channel Type	2	Binary	23
Reserved	2	N/A	N/A
Enabled	1	ASCII	“Y” - enabled, or “N” - disabled
Actual Rate	4	Binary	Actual word rate in words per second
Words Per Frame	4	Binary	Number of words per frame
Reserved	4	N/A	N/A
Bits Per Word	2	Binary	16
Reserved	4	N/A	N/A
Channel Number	2	Binary	Channel on module (0-3)
Module ID	1	Binary	Module ID = hexadecimal 13
Reserved	1	N/A	N/A
Requested Rate	4	Binary	Bits per second

**Table A.4-14. Bit Sync Input Channels**

Field	Bytes	Format	Description
Description	20	ASCII	Channel description
Installed	1	Binary	0 = daughter board not installed 1 = daughter board installed
PCM geographical address	1	Binary	Geographical address of the associated PCM input channel
Source Clock	1	Binary	0 = source A 1 = source B
Reserved	7	N/A	N/A

### 2.3. Trailer Section

The trailer section contains the setup description and the checksum (see [Table A.4-15](#)). Early versions of the setup do not contain this information. The “Setup Keys” field in the header indicates the content of the trailer section.

**Table A.4-15. Trailer Section Format**

Field	Bytes	Format	Description
Setup Description	40	ASCII	Description of the setup
Saved Scanlist	Varies	Binary	Number of bytes depends on the number of channels being recorded.
Checksum	4	Binary	Sum of all setup bytes

### 2.4. Saved Scanlist Structure

This is an array of enabled input channels that make up the calculated scan-list. Each element of the array is made up of two fields, an index field and a count field. The length of the index field is one byte, and the length of the count field is two bytes.

- a. The index field, which is 1-based, is determined by the position of the channel’s module in the ARMOR system. The first input channel found in the ARMOR system is assigned an index of one (1), the next input channel is assigned a two (2), and so on. The search for input modules starts at slot 1. Filler bytes are assigned an index value of 255.
- b. The count field is the number of words/samples per frame that is assigned to that input channel.

### 2.5. Creating a Setup Block

Creating a setup block involves two steps. In the first step, the user creates an “input” setup block file as described below in this section. Most of the fields in the input setup block file are unspecified (filled with zeros). In the second step, the input setup block file is read by the ARMOR compiler program that produces a new setup block file with all the unspecified fields initialized to the appropriate values. In other words, a setup block has two types of fields, user specified and compiler generated. Note that all compiler-generated fields must be provided in the

input setup block file and initialized with zeros prior to executing the ARMOR compiler program.

The rules presented in this section must be explicitly followed to create an ARMOR input setup block. Values for fields identified in the previous tables with an asterisk preceding the field name must be provided. In some cases, the values for these required fields are constant and are specified in the tables above. In other cases, the user must provide the desired value. All fields with names not identified with asterisks must be initialized to binary zero. This includes both unused and reserved fields.

Only input channel information entries are required. Output channel information entries are ignored by the ARMOR compiler program.

#### 2.5.1. Header Section

Setup Length:	Count the total numbers of bytes in the created setup block and put the value here.
Setup Keys:	Set bit 0 = 1 if the trailer contains a description. Leave other bits = 0.
Input Count:	Enter the total number of input channel information entries, including both enabled and disabled entries.

#### 2.5.2. Channel Section

PCM, low-frequency (LF) analog, and parallel input channel information entries must be included in the setup block in groups of four entries per type. High-frequency (HF) analog input channel information entries must be included in the setup block in groups of two entries per type. Time code/voice input channel information entries must be included in groups of three time code entries and one voice entry. Specifying an ASCII “N” in the enabled field must disable all unused input channel information entries. For each channel information entry group, the channel number field of the first entry in the group is zero, the second entry is one, the third is two, and the fourth is three. For the time code/voice group, the time code entry channel number fields are 0, 1, and 2, respectively, while the voice entry channel number field is 3. The HF analog entry channel number fields are 0 and 1, respectively.

Description fields are not required and are not specified below; however, it is advisable to include an ASCII description of each channel for future reference.

##### 2.5.2.1. PCM Input Channels

Channel Type:	Binary 8
Enabled:	ASCII “Y” if enabled, “N” if disabled
Channel Number:	Binary 0, 1, 2, or 3 as described in Subsection <a href="#">2.5.2</a> above
Module ID:	Hexadecimal 11
Requested Rate:	Binary integer rate in bits per second

##### 2.5.2.2. Analog Input Channels

Channel Type:	Binary 5 for LF (up to 1 megasample/sec), 6 for HF (up to 10 megasamples/sec)
---------------	---

Enabled: “Y” if enabled, “N” if disabled  
Bits per Sample: 8 or 12  
Channel Number: 0, 1, 2, or 3 as described in Subparagraph [2.5.2](#) above  
Module ID: Hexadecimal 34 (LF) or 33 (HF)  
Requested Rate: Binary integer 2K, 5K, 10K, 20K, 50K, 100K, 200K, 500K, 1M (LF, HF) 2.5M, 5M, 10M (HF only)

2.5.2.3. *Parallel Input Channels*

Channel Type: Decimal 13  
Enabled: “Y” if enabled, “N” if disabled  
Channel Number: 0, 1, 2, or 3 as described in Subparagraph [2.5.2](#) above  
Module ID: Hexadecimal 92  
Requested Rate: Binary integer 8-bit words (bytes) per second

2.5.2.4. *Time Code Input Channels*

Channel Type: Decimal 15 (1st entry), 19 (2nd entry), 20 (3rd entry)  
Enabled: “Y” if enabled, “N” if disabled, all three entries must be the same  
Bits per Word: Decimal 24 (1st entry), 24 (2nd entry), 16 (3rd entry)  
Channel Number: 0, 1, or 2 as described in Subparagraph [2.5.2](#) above  
Module ID: Hexadecimal B1  
Requested Rate: 1  
Bits per Sample: Decimal 24 (1st entry), 24 (2nd entry), 16 (3rd entry)

2.5.2.5. *Voice Input Channels*

Channel Type: Decimal 16  
Enabled: “Y” if enabled, “N” if disabled  
Bits per Word: 8  
Channel Number: 3 as described in Subparagraph [2.5.2](#) above  
Requested Rate: Integer 2K, 5K, 10K, 50K, 100K  
Bits per Sample: 8

2.5.3. *Trailer Section*

The trailer section of the input setup block is not required. The user may include an ASCII text setup description in the trailer section by setting the setup keys bit 0 = 1 in the header section (see Paragraph [2.5.1](#) above) and adding the setup description field only in the trailer section.

2.5.4. *ARMOR Compiler Program*

Operational instructions for the ARMOR compiler program are provided in the readme.txt file provided with the compiler.



**\*\*\*\* END OF ANNEX A.4 \*\*\*\***