



10TH SEMINAR

**METHODS AND TECHNIQUES FOR  
NEAR-REAL TIME TEST  
DATA REDUCTION AND ANALYSIS**

**18 AUGUST 1993**

**CONFERENCE CENTER  
TYNDALL AIR FORCE BASE, FLORIDA**

**DATA REDUCTION AND COMPUTER GROUP**

**WHITE SANDS MISSILE RANGE  
KWAJALEIN MISSILE RANGE  
YUMA PROVING GROUND  
DUGWAY PROVING GROUND  
COMBAT SYSTEMS TEST ACTIVITY**

**ATLANTIC FLEET WEAPONS TRAINING FACILITY  
NAVAL AIR WARFARE CENTER WEAPONS DIVISION  
NAVAL AIR WARFARE CENTER AIRCRAFT DIVISION  
NAVAL UNDERSEA WARFARE CENTER DIVISION, NEWPORT  
PACIFIC MISSILE RANGE FACILITY**

**30TH SPACE WING  
45TH SPACE WING  
AIR FORCE FLIGHT TEST CENTER  
AIR FORCE DEVELOPMENT TEST CENTER  
AIR FORCE WEAPONS AND TACTICS CENTER  
SPACE AND MISSILE SYSTEMS CENTER,  
SPACE TEST AND EXPERIMENTATION PROGRAM OFFICE  
ARNOLD ENGINEERING DEVELOPMENT CENTER**

**10TH SEMINAR**

**METHODS AND TECHNIQUES FOR  
NEAR REAL-TIME TEST  
DATA REDUCTION AND ANALYSIS**

**18 AUGUST 1993**

**CONFERENCE CENTER  
TYNDALL AIR FORCE BASE, FLORIDA**

**DATA REDUCTION AND COMPUTER GROUP  
RANGE COMMANDERS COUNCIL**

**Published and Distributed by**

**Secretariat  
Range Commanders Council  
White Sands Missile Range, NM 88002-5110**

## P R E F A C E

This seminar was proposed during the 78th Data Reduction and Computer Group (DR&CG) meeting held at the 30th Space Wing, Vandenberg Air Force Base, California, to take place at the 79th or 80th DR&CG meeting. During the seminar, it was recognized that changes are taking place rapidly in test data reduction methods. At issue is "quicker turnaround time," although a more correct view might be "test data reduction on demand." With modern engineering workstations which are improving daily, the increased power of personal computers, compact disk-read-only memory (CD-ROMs), laser printers, high-capacity hard disks, and an ever increasing arsenal of general purpose software capabilities, support requirements for data analysis and display can be obtained at a higher level.

With such support, a computer system can be tailored to fit many applications better than many techniques used in the past for software development, modification, and checkout. Processes which took weeks, months, or even years now take hours, days, and weeks. The papers presented at this seminar demonstrate steps taken by member and associate member representatives to take advantage of the new technologies.

# TABLE OF CONTENTS

	<u>Page</u>
<b>PREFACE</b> .....	iii
<b>AGENDA</b> .....	vii
Near Real-Time Data Reduction: AFDTC Examples - D. Aaron Coffman and Lynda Davila, Air Force Development Test Center.....	1
AEDC Engine Test Facility Near Real-Time Data Processing Capability - Al Westerhoff, Arnold Engineering Development Center.....	29
Test Data Visualization: An Analytical Tool for Data Reduction and Analysis - Jerry Taylor and Tomas Bozack, Naval Air Warfare Center Weapons Division, China Lake.....	71
TSPI Data Processor Development - Kenneth J. Williamson, Air Force Wright Laboratory/Armament Directorate.....	81
The Development and Production of Near Real-Time Reports at White Sands Missile Range - Michael S. Garcia, White Sands Missile Range.....	119
Appendix A - First NRTR Template.....	131
Appendix B - Refined NRTR Template.....	136
Appendix C - First Actual NRTR.....	140
Desktop Data Analysis - John Shields, Naval Air Warfare Center Aircraft Division, Patuxent River.....	145
Data Analysis Network - Henry Bunch, Air Force Flight Test Center.....	165

# AGENDA

## Range Commanders Council Data Reduction and Computer Group

### Methods and Techniques for Near Real-Time Test Data Reduction and Analysis

18 August 1993

- 0745      Announcements
- 0800      "AEDC Engine Test Facility Near Real-Time Data Processing  
            Capability"  
            Al Westerhoff - Arnold Engineering Development Center
- 0900      "Near Real-Time Data Reduction: AFDTC Examples"  
            Lynda Davila and Aaron Coffman  
            Air Force Development Test Center
- 1000      "Near Real-Time Test Data Visualization"  
            Jerry Taylor - Naval Air Warfare Center Weapons Division  
            China Lake
- 1100      "Near Real-Time Data Optimization"  
            Ken Williamson - Aeronautical Systems Center  
            Wright Laboratory - Armament Directorate
- 1130      Lunch
- 1230      "Real-Time Display and Reporting of T&E Data at WSMR"  
            Michael Garcia - White Sands Missile Range
- 1330      "Desktop Data Analysis"  
            John Shields - Naval Air Warfare Center Aircraft Division  
            Paxtuxent River
- 1430      "Data Analysis Network"  
            Henry Bunch - Air Force Flight Test Center
- 1515      Discussion of Papers



## Near Real-Time Data Reduction AFDTC Examples

*Authors:* Mr. D. Aaron Coffman  
Ms. Lynda Davila  
Computer Scientists

*Address:* 646 CCSG/SCWS  
201 W Eglin Blvd Suite 259  
Eglin AFB, FL 32542-6829

### Abstract

Using the Radar Warning Receiver (RWR) and INS/GPS Operation Concept Demonstration (OCD) test programs as examples, this abstract describes the test data processing techniques and methodologies which characterize the current trend toward the integration of real-time and near real-time data reduction. Included in this description are the test data requirements, the real-time and near real-time data reduction processes, and the efficiencies gained/value added to the test programs.

### RWR Example

The Radar Warning Receiver (RWR) test results of an open air test mission are needed on the same day of the mission. To achieve this goal, the entire data collection, reduction, analysis, and reporting cycle must be optimized and/or automated.

The Mission Analysis and Reporting System (MARS) is an existing custom-built tool for EW mission data management, analysis, and reporting. In its current state, MARS provides tools to retrieve, display, and analyze Electronic Warfare (EW) performance data through the user-friendly Microsoft Windows interface. In support of EW open air testing of RWR systems, the 646CCSG MARS Team has underway a near real-time RWR data reduction initiative to provide today's test results today. This initiative consists of two parts: to collect and process the test data as close to real-time as possible and to expand MARS to provide (both graphically and numerically) Response/Ageout Time, DF Error, and Range Error Analysis.

Open air RWR testing includes the real-time collection of telemetered RWR data, the real-time collection of microwaved threat system data from a multitude of threat missile and gun systems, and the real-time collection of microwaved time space position information (TSPI). To bring all the various sources of test data into a dedicated high speed processing environment, an extensive hardware integration effort is currently underway. At the completion of this initiative, there will be, at a minimum, the integration of three DEC Alpha (DEC 3000 Model 500S Advantage Server) processors: one for telemetry collection, one for Threat/TSPI collection, and one for dedicated EW data processing.

The test data will be processed near real-time pass by pass, resulting in five disk files: RWR Display Data, Mission Pass Start/Stop Times, Threat Site Activity, Control Radar TSPI, and Aircraft Attitude Data. MARS will import these files immediately after the mission, enabling the Test Engineer, on a PC at his desk, to quickly analyze the results from that day's mission.

### OCD Example

The test item for the OCD test program was an inert GBU-15 with the standard electro-optical guidance system replaced by an integrated INS/GPS guidance system. Test data requirements included real-time telemetry and TSPI for mission analysis, eight separate quick-look reports immediately following mission completion, and large quantities of data within four hours for in-depth analysis.

Customized real-time software enabled the analysts to monitor the weapon's digital data, the aircraft's telemetry, and radar data on displays located in the Central Control Facility mission control rooms. Hard copies of the displays and tailored reports were available immediately after the mission.

The follow-on data reduction processes were automated by logging all raw telemetry and radar data to disk during the mission. These data files were then converted by menu-driven software into Dataprobe format and stored in the test analyst's disk area for interactive analysis. The test analyst utilized the Dataprobe software executing on the Eglin Computer Network (ECONET) to produce final reports.

This integrated data processing approach provided customized real-time and near real-time data products to the test customer as well as a complete data set available for in-depth interactive analysis within four hours. Significant savings of time and cost were realized when compared with conventional post mission data reduction procedures. Key elements of the process were the utilization of real-time software to produce tailored quick-look reports, real-time data archival, use of commercial-off-the-shelf software for interactive data analysis, and allowing the test analysts to interact during the data reduction process.

### Summary

The modern test scenario must include three elements: real-time collection of data, dedicated near real-time processing of that data, and a tailored personal analysis tool. These near real-time data reduction initiatives are yet another advance enabling the Air Force Development Test Center to provide *today's test results today!*

---

***Near Real-Time Data Reduction  
AFDTC Examples***

***Aaron Coffman  
Lynda Davila***

---

***August 18, 1993***



# ***Near Real-Time Data Reduction AFDTC Examples***

---

1. AFDTC Goal
2. Achieving the Goal
3. AFDTC Examples

# ***Goal***

---

***Provide results of today's custom test today***

# ***Required Elements of Modern Open-Air Flight Tests***

---

1. RT Data Acquisition
  - Control/Threat Radar data
  - Telemetry data
2. Near Real-Time Reduction
  - Control/Threat Radar data
  - Telemetry data
3. Interactive Analysis Tools
  - Advantages
  - Mission Analysis and Reporting System
  - Dataprobe

# Real-Time Data Acquisition CCF Test Support

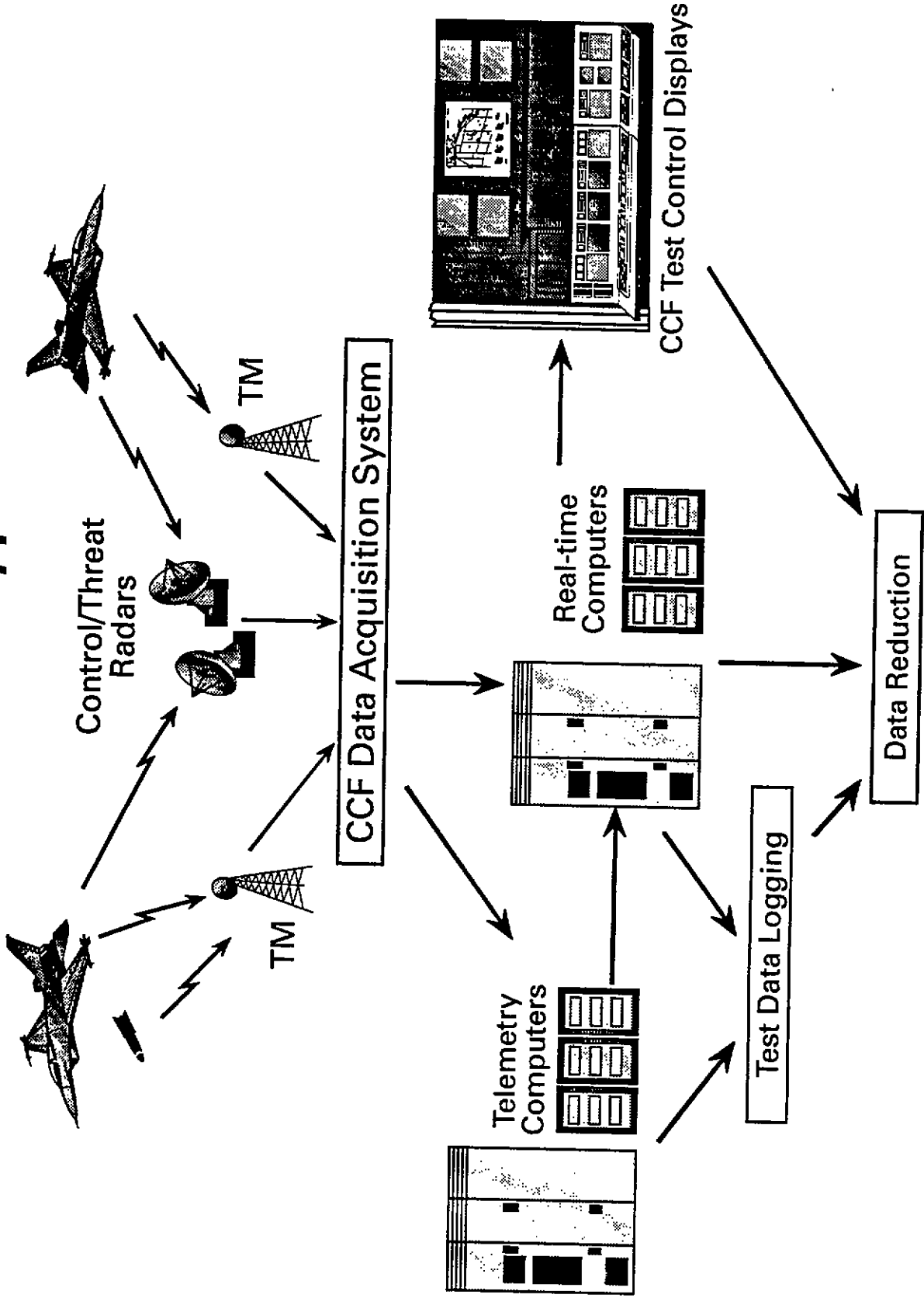

# Near Real-Time RWR Reduction

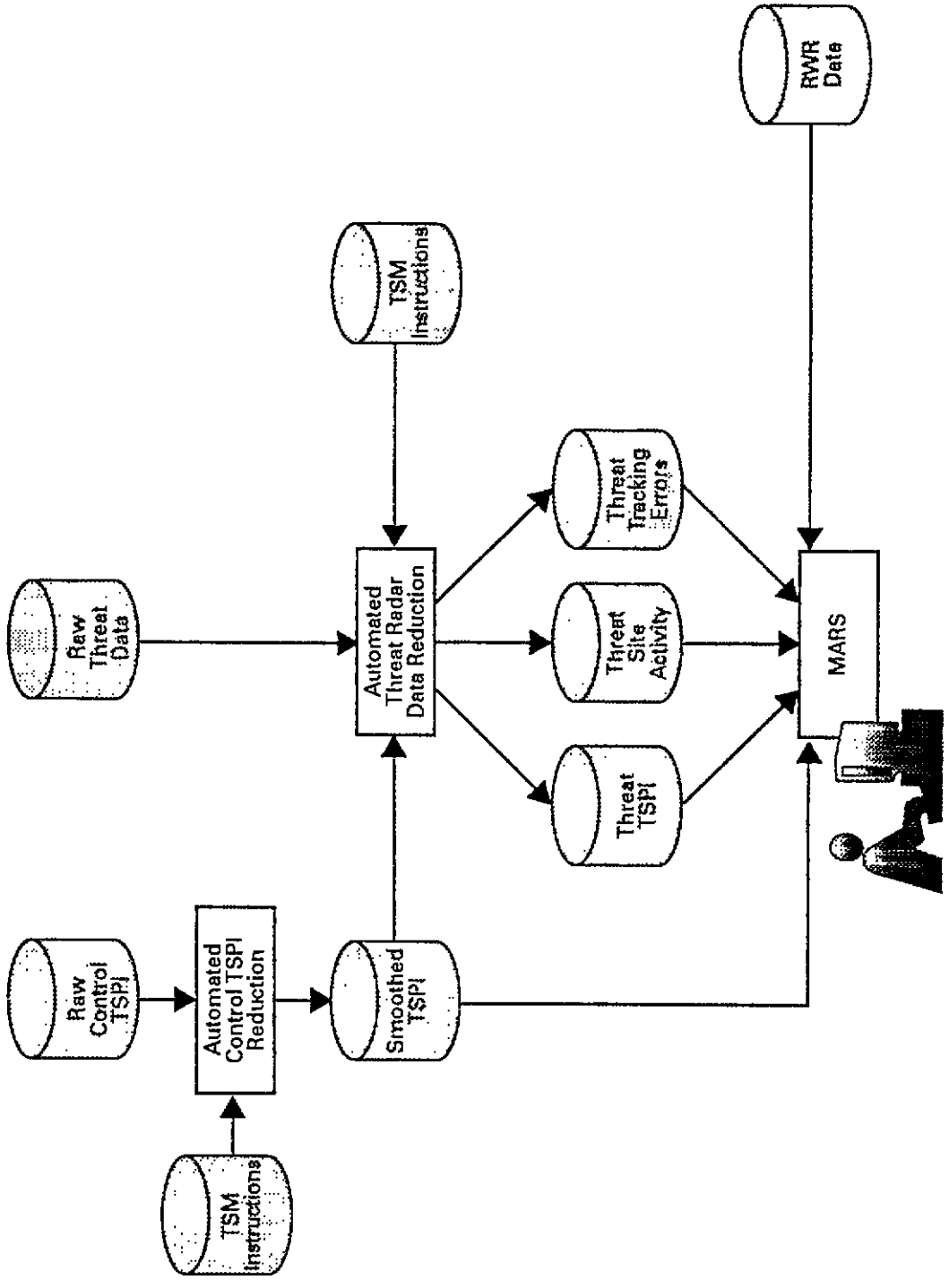

# ***Interactive Analysis Tools***

---

- **Faster turnaround**
- **Flexibility for test engineer**
- **Uniform analysis**
- **Incremental processing available**
- **Standardized input files**



# Mission Analysis and Reporting System (MARS)

MARS is a PC based data analysis and reporting tool designed to support test and evaluation of electronic warfare systems

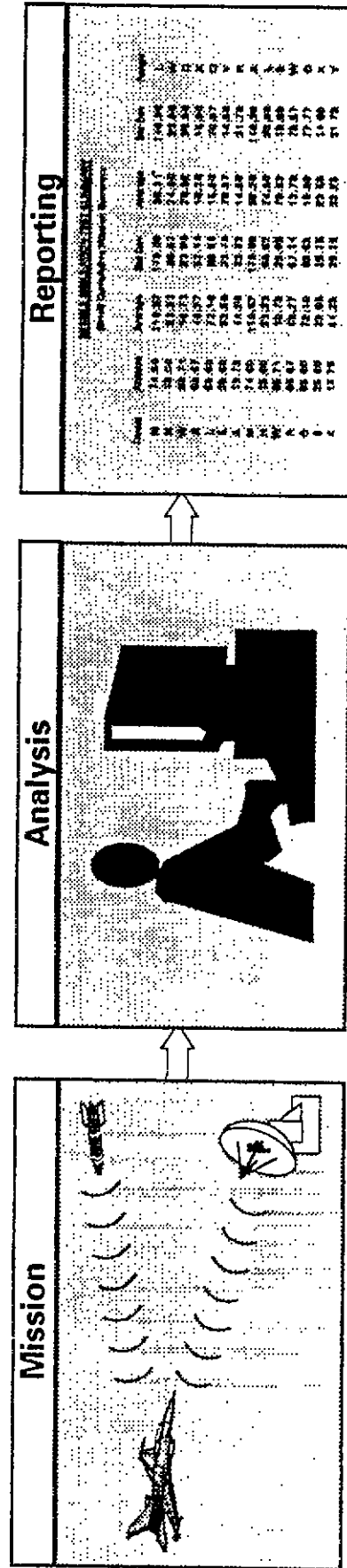



# ***MARS Capabilities***

---

- **Data review and editing**
  - Tabular data browser
  - Multi-level sort capability
  - Single-variable descriptive statistics
  
- **Mission analysis**
  - Reduction-in-lethality
  - Response time/Response range
  - "What-If" analysis via user-editable pass log and lethal radius tables
  - Rapid test and mission evaluation
  
- **Flexibility**
  - Interactive PC Windows environment
  - Interfaces with commercial PC software packages (e.g., Excel, Word)





# Typical Operation

Mission data are converted and added to the Mission Analysis Data Base

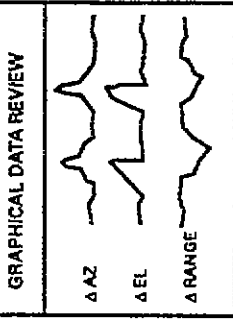
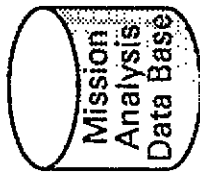
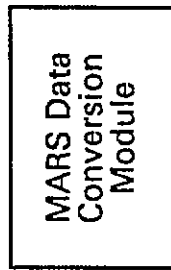
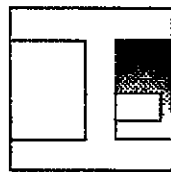

PARAMETER	UNIT	VALUE	UNIT	VALUE
ALTITUDE	FT	10000	ALTITUDE	10000
VELOCITY	FT/S	1000	VELOCITY	1000
ACCELERATION	G	1.0	ACCELERATION	1.0
ANGLE	DEG	45	ANGLE	45
TIME	SEC	100	TIME	100
...	...	...	...	...

Data are reviewed and edited in graphical and tabular formats

- Floppy disk
- Optical disk
- Multiple data formats
- All missions
- All passes
- All test conditions

Mission results are added to the summary data base for cumulative and comparative analysis

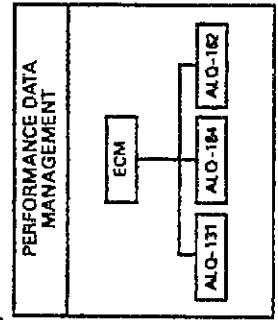
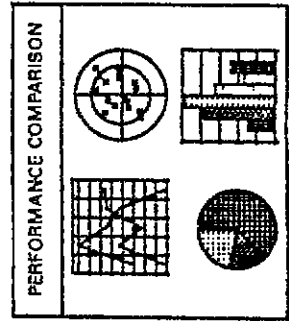

REPORT SECTION	STATUS	DATE	TIME
MISSION SUMMARY	COMPLETE	10/10/80	14:30
PERFORMANCE DATA	COMPLETE	10/10/80	14:30
EFFECTIVENESS EVALUATION	COMPLETE	10/10/80	14:30
TEST REPORT	COMPLETE	10/10/80	14:30
...	...	...	...

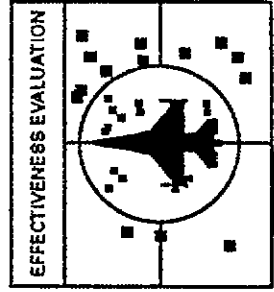
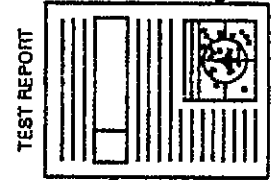

Standard measures of effectiveness are computed and displayed



# Family

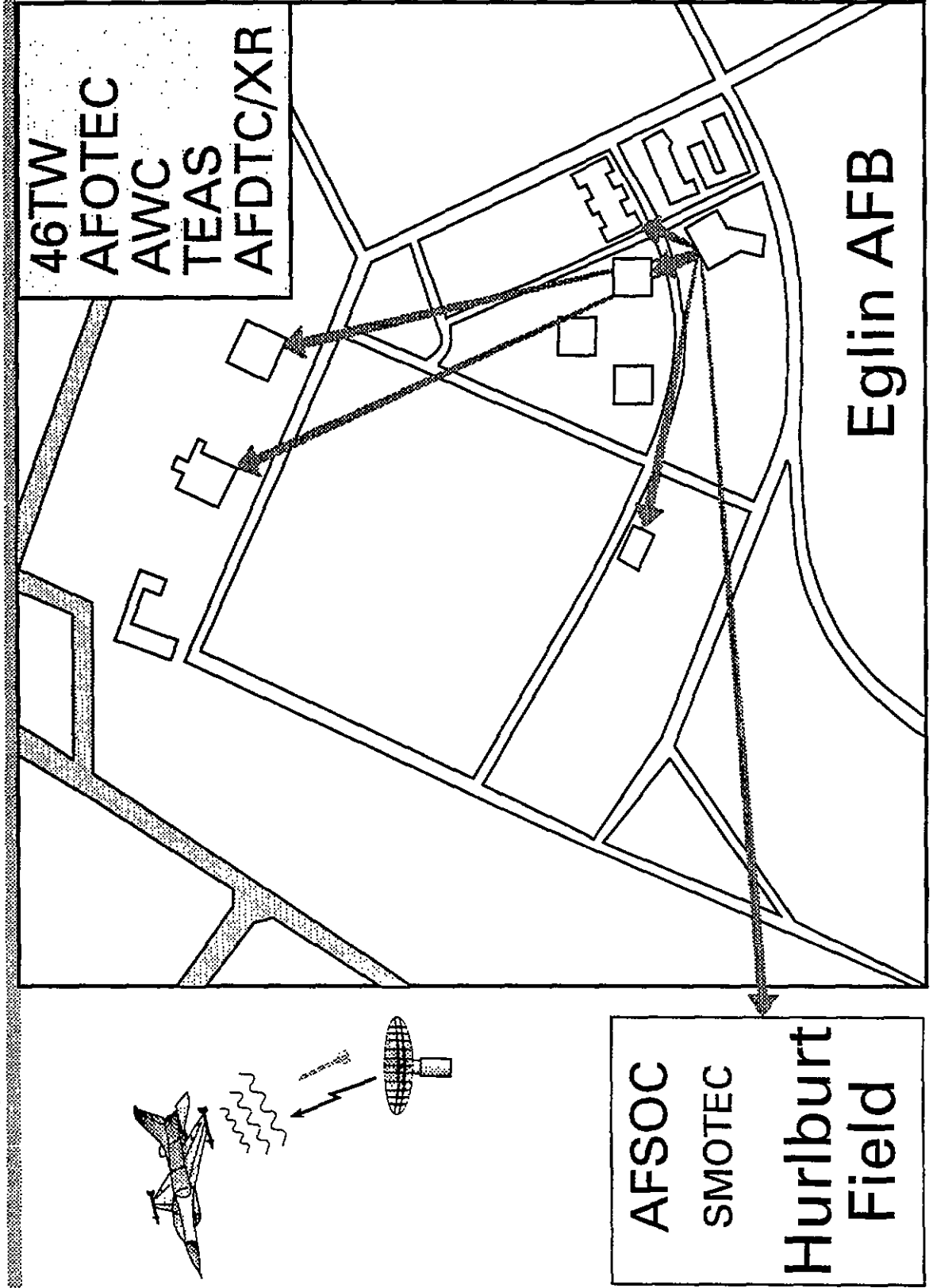



# Friends

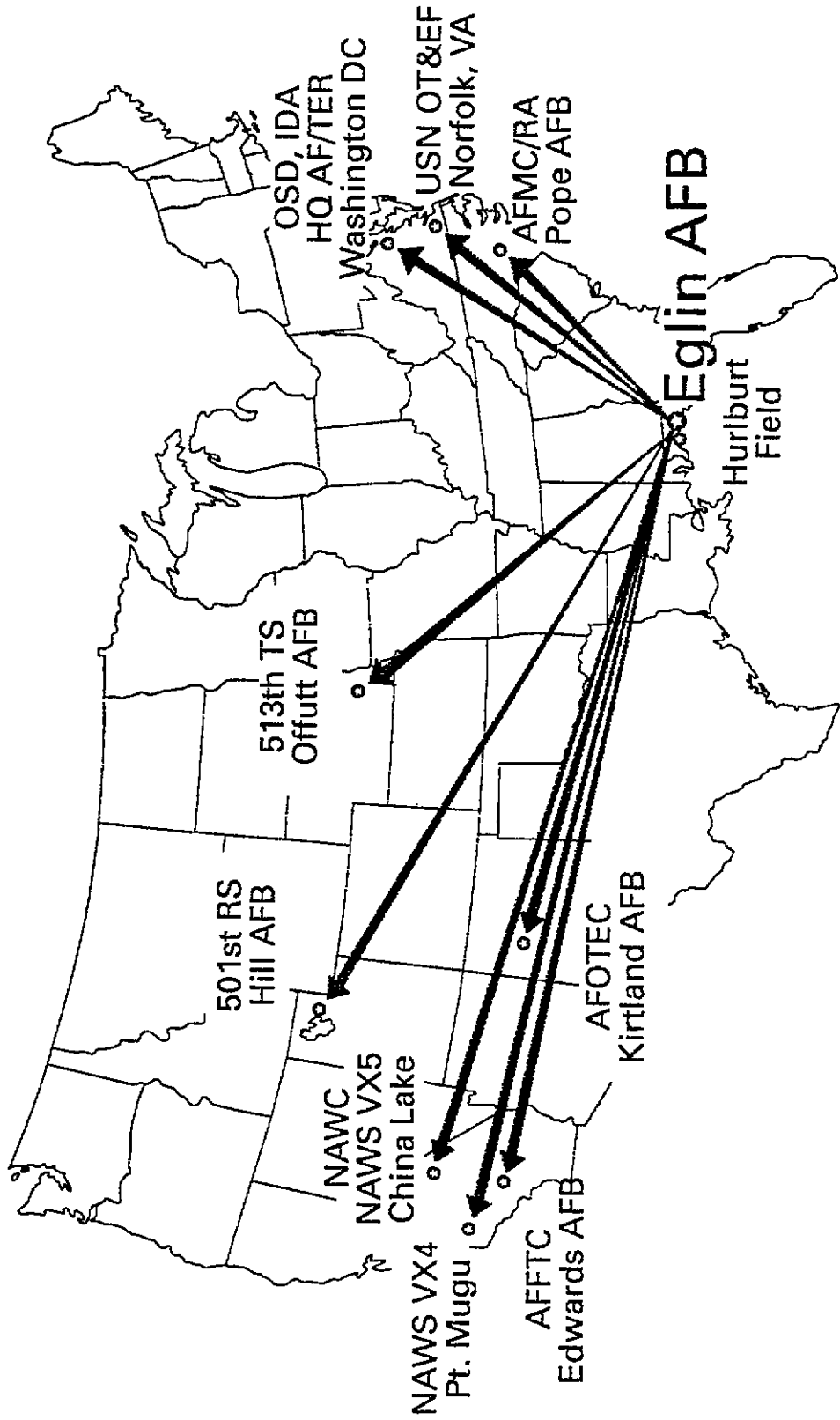

# ***Customer Response***

---

**"This is definitely the most customer-responsive program I've seen in years."**

**"With the present capability and the future improvements of MARS, we will be in a position to better support ACC and USAF goals."**

**-- AFDTC Customer**

# ***Near Real-Time Data Reduction***

---

## ***A Munitions Test Example***

- Opportunity
- Constraints
- Challenges
- Solution
- Execution
  - Real-time
  - Post mission
- Summary

# ***Opportunity***

---

- **INS/GPS operational concept demonstration**
- **Precursor to Phase I of JDAM**
- **GBU-15 with integrated GPS receiver and INS guidance kit**
- **Prove viability of INS/GPS package**
- **Six launches from Block 40 F-16**

# ***Constraints***

---

- 12 months weapon inception to test completion
- 4-hour post mission turnaround
- Minimize cost

# ***Challenges***

---

- Immediate real-time reports
- Non-standard weapon PCM stream
- Large volumes of data
- Varied data analysis
- Directly compare various data sources



# ***Solution***

---

- Real-time
  - Provide displays needed to make real-time decisions
  - Generate real-time reports
- Post mission
  - Dataprobe

# ***Execution***

---

## ***Real-time***

- 14 customized graphical displays
  - 100 weapon digital parameters
  - 20 aircraft parameters
  - 15 radar parameters
- Safety display
  - 20 radar parameters
- Strip charts
  - Analog parameters
- 8 sets of reports generated in real-time
- Hardcopies of displays
- All raw data logged to disk

# **Execution**

## **Post Mission**

- Dataprobe software system is a powerful, interactive time-series analysis and graphics tool
- Gives engineers and analysts direct access to potentially large data sets
- Data may be presented in plot format or a tabular listing
- Data may be presented on the terminal display unit or sent to hard copy
- Analysis Tools
  - User defined functions
  - Built-in functions:
    - FFTs to calculate power/Hz
    - Auto covariance
    - Cross-covariance
    - Histograms
    - Mean and standard deviation

# ***Analysis Tool***

---

## ***Dataprobe***

- Engineering unit conversions
- Raw data in Dataprobe STD format
- Software available for raw data to Dataprobe STD file conversion
  - Aircraft PCM data
  - TSPI data
- Software developed to convert message data into Dataprobe STD format
- Automation of conversion process

# ***Reduction***

## ***Post Mission Processing***

- Automated immediate data processing
- Raw data into Dataprobe format
  - OCD weapon digital
  - OCD weapon analog
  - F-16 PCM
  - Radar
- All Dataprobe files automatically sent to user's mass storage area within 4 hours following mission

# Real-Time Data Acquisition CCF Test Support

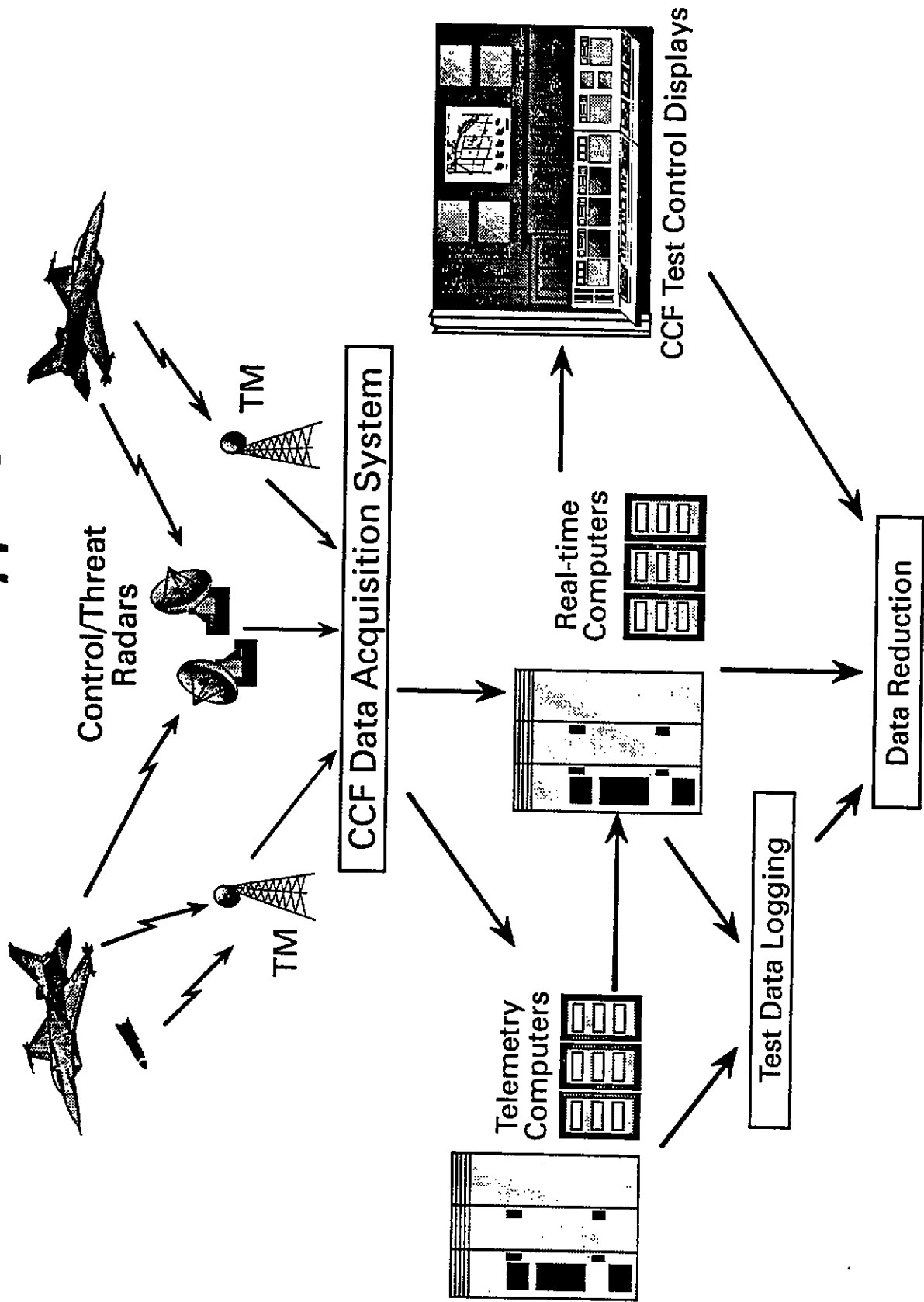

# Near Real-Time OCD Dataflow

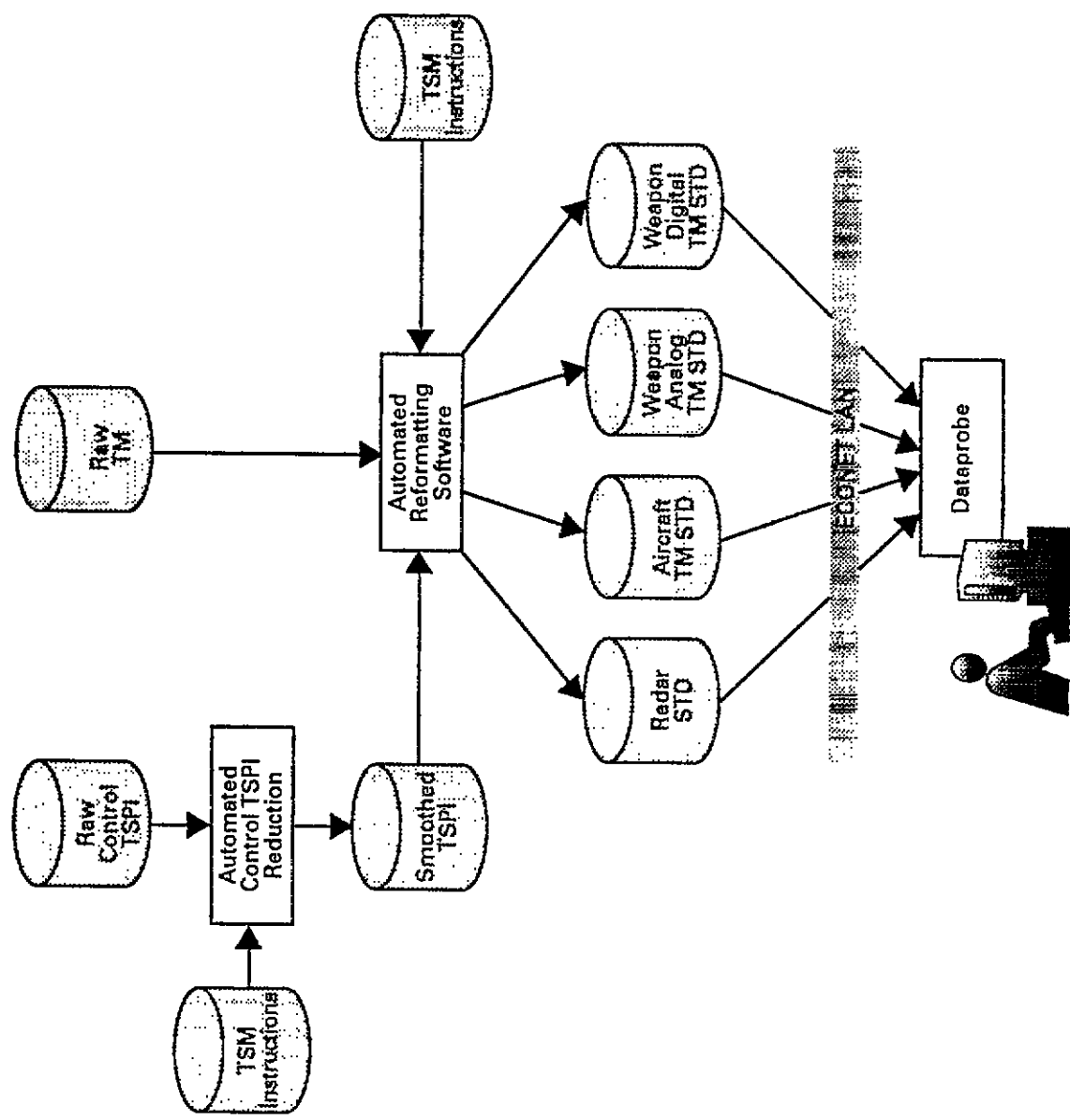

# Summary

---

- OCD considered a "success"
- Real-time analysis and reporting capability contributed to success
- Near real-time turnaround
  - Hands-on in-depth analysis capability
  - 4 hours following mission
- Completed in 13 months
- 5 successful drops
- Costs reduced



# ***Customer Feedback***

---

- **OCD Program Office comments:**
  - “Your task was critical to the timely success of our program. The result was a very effective data reduction format derived from a very foreign PCM data stream.”
  - “Your work allowed us to virtually evaluate and preliminarily assess weapon system problems as they occurred in real time.”
  - “Your efforts directly affected our ability to turn missions: to have the resource available to evaluate system anomalies, thereby allowing us to make informed mission execution decisions.”

**RANGE COMMANDERS COUNCIL  
79TH DATA REDUCTION AND COMPUTER GROUP MEETING**

**AEDC ENGINE TEST FACILITY  
NEAR REAL-TIME  
DATA PROCESSING CAPABILITY**

**TYNDALL AFB  
AUGUST 18, 1993**

## TABLE OF CONTENTS

- PROPULSION TESTING FUNCTIONS
- ENGINE TEST FACILITY DATA PROCESSING OVERVIEW
- C-CELLS NEAR REAL-TIME DATA PROCESSING
- FUTURE PLANS
- CURRENT UPGRADE EFFORTS

# Major Propulsion Testing Functions

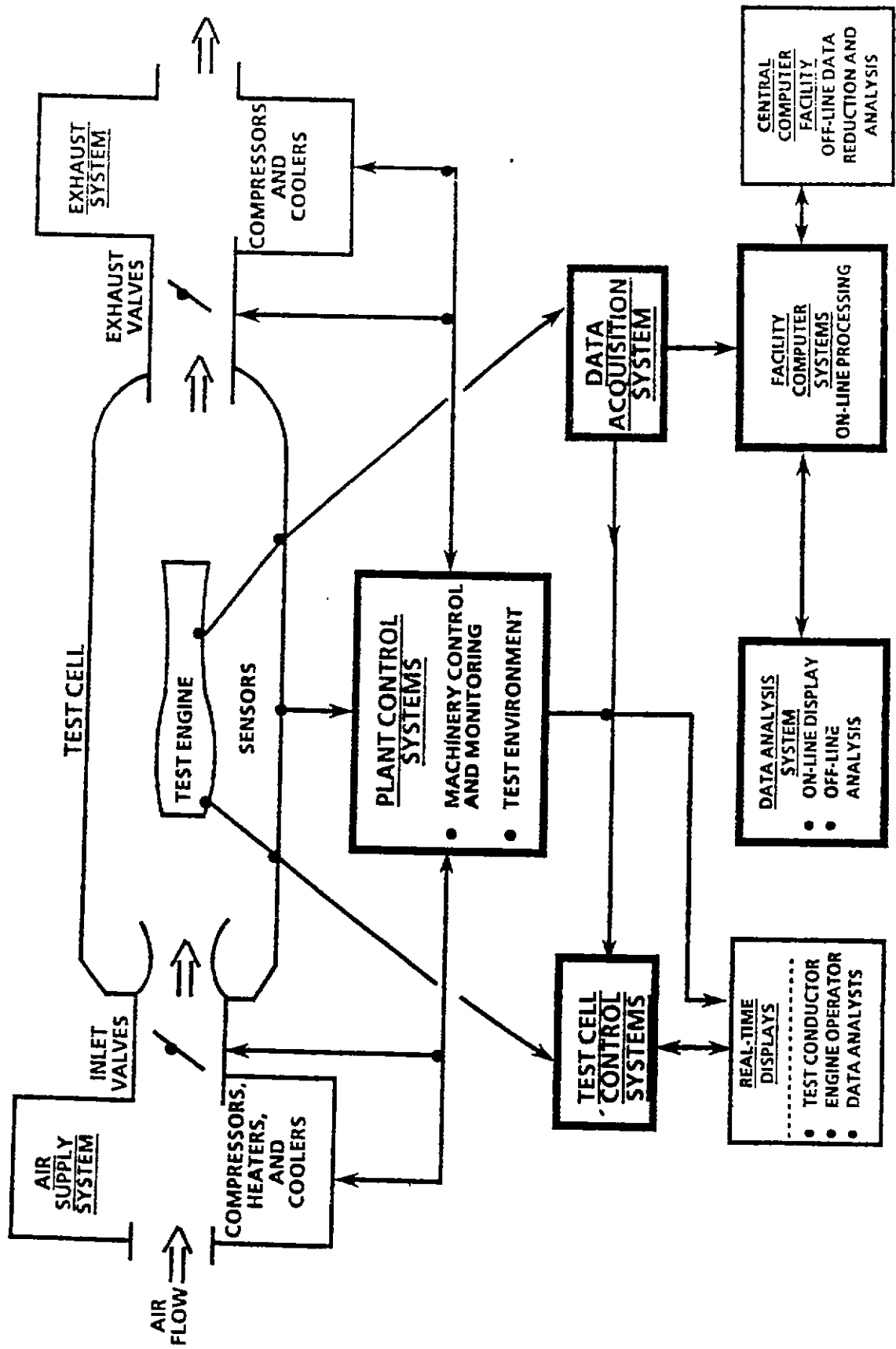

# ENGINE TEST FACILITY DATA PROCESSING OVERVIEW

# AEDC TURBINE ENGINE TESTING DATA ACQUISITION/PROCESSING OVERVIEW

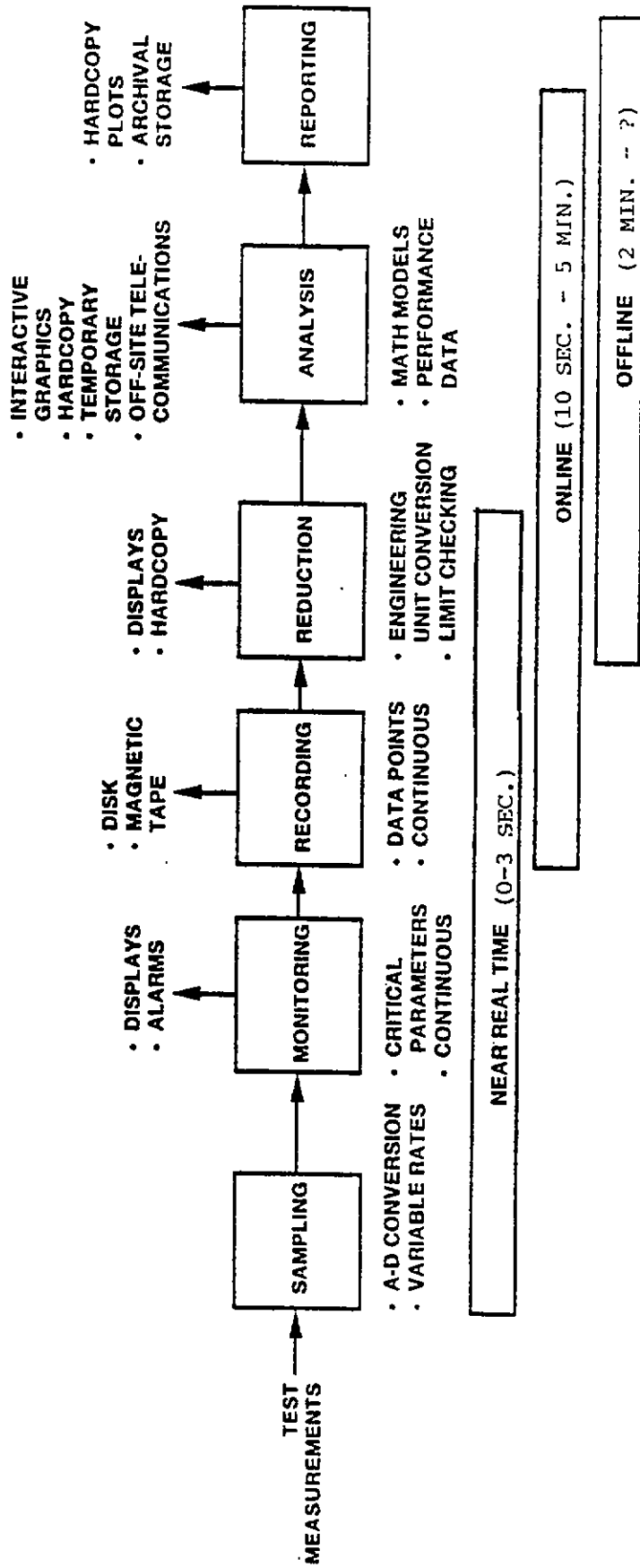

# Current Propulsion Testing SS/Transient Test Data Acquisition/Processing Systems Overview

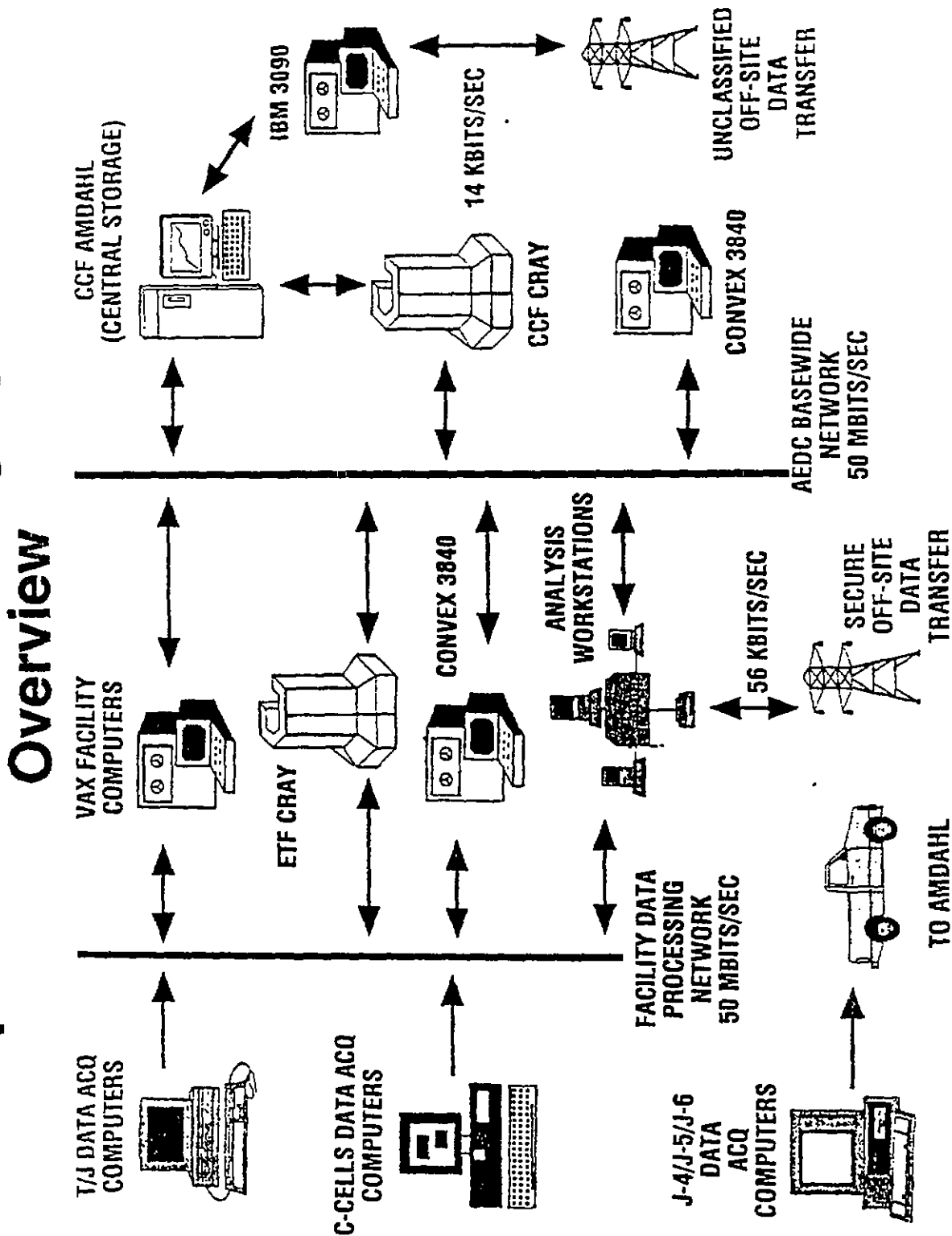

# Data Acquisition Systems

System	Host Computers	No. of Computers/ Systems	Test Cells Supported
<b>T/J Data Acquisition System</b> <ul style="list-style-type: none"> <li>• 200-700 channels per test cell</li> <li>• 160,000 samples/sec max throughput</li> </ul>	GOULD 32/27 & 77	4	16
<b>C-Cells Data Acquisition/Processing System</b> <ul style="list-style-type: none"> <li>• 1,050 channels per test cell</li> <li>• 320,000 samples/sec acquisition rate</li> <li>• Real-time data compression/E.U. conversion</li> <li>• 40,000 samples/sec max. throughput</li> </ul>	<b>MODCOMP CLASSIC</b> DEC VAX 486 PC	9 2 46	2
<b>J-4/J-5/J-6 Data Acquisition System</b> <ul style="list-style-type: none"> <li>• 350-500 channels per test cell</li> <li>• 250,000 samples/sec max. throughput</li> </ul>	DEC PDP-11/70 DEC VAX-11/780	3 2	3
<b>Aerodynamic Pressure Measuring Systems</b> <ul style="list-style-type: none"> <li>• 300-1,300 channels per test cell</li> <li>• 50,000 samples/sec. acquisition rate</li> <li>• Real-time averaging/E.U. conversion</li> </ul>	386 PC	10	10
<b>Non-interference Stress Management System</b> <ul style="list-style-type: none"> <li>• Optically measures turbine rotor blade vibrations</li> <li>• Data processed to identify/display vibration amplitude and frequency</li> </ul>	DEC VAX-11/750 NUMERIX NMX432 APTEC 2400	1 1 1	"Portable"



# Facility Computer Systems

- **DEC VAX 8650s (3)**
  - **Temporary data storage and routing**
  - **E.U. conversion**
  - **Steady-state engine performance processing**
  - **Software development**
- **Cray XMP/14SE and Convex 3840 supercomputers**
  - **E.U. conversion**
  - **Steady-state engine performance processing**
  - **Transient engine performance processing**
  - **Basewide CFD processing support**

# AEDC PROPULSION TESTING TYPICAL TURNAROUND TIMES FOR TEST DATA PROCESSING & ANALYSIS

TYPE OF TESTING	REAL-TIME/NEAR REAL-TIME DATA DISPLAYS	ON-LINE/QUICK-LOOK PROCESSED DATA	INITIAL PERFORMANCE DATA	FORMAL DATA PACKAGE	
				PRELIM.	FINAL
TURBINES	0 - 3 SECONDS	10 SECONDS TO 5 MINUTES	10 SECONDS TO 5 MINUTES	24 HOURS	2 - 10 DAYS
ROCKETS	0 - 0.2 SECONDS	5 - 10 MINUTES	2 HOURS	10 DAYS	20 DAYS

# C-CELLS NEAR REAL-TIME DATA PROCESSING

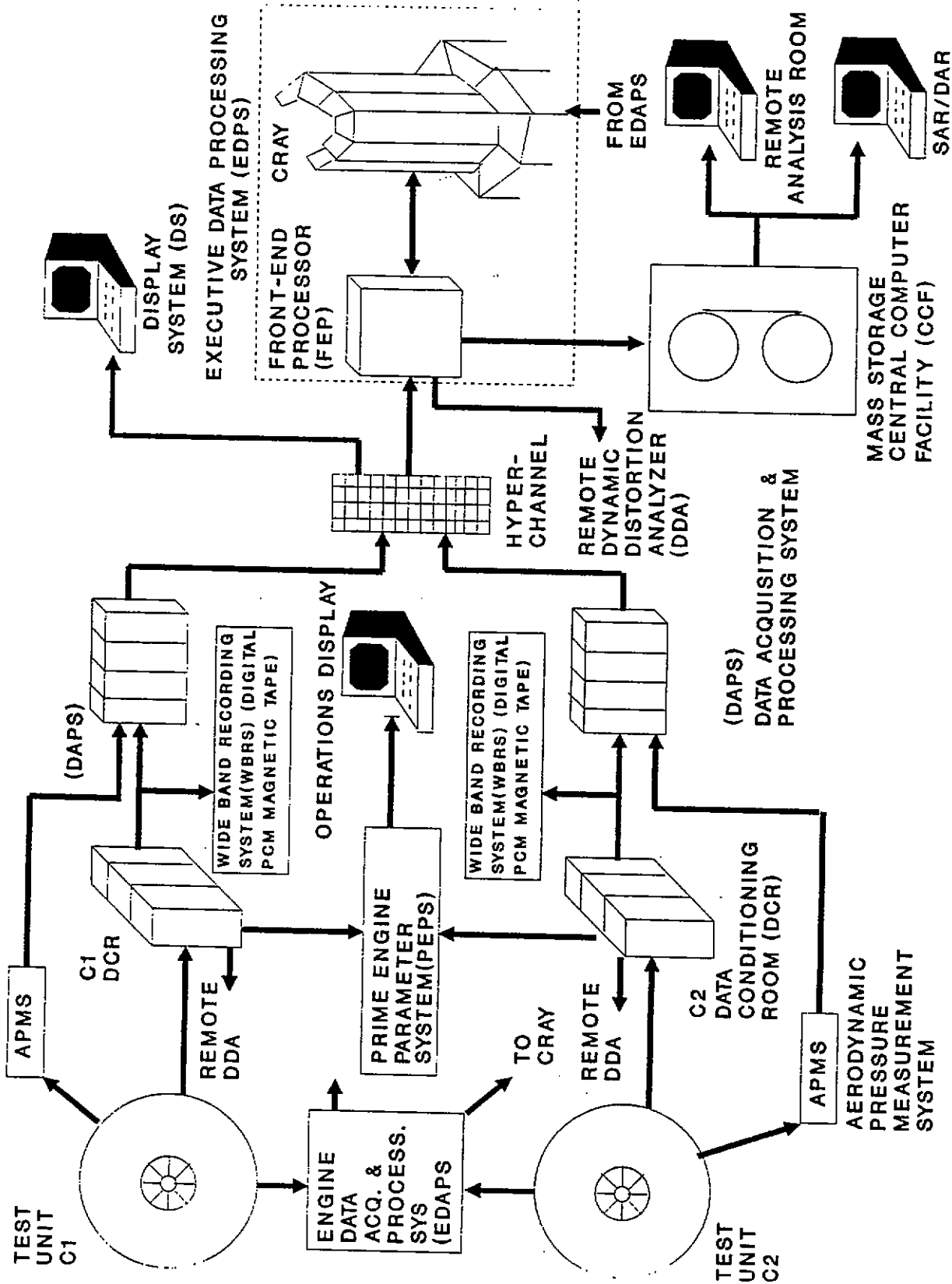

# CDAPS DATA FLOW

## TYPICAL TURNAROUND TIME FOR DIGITAL DATA

- **ON-LINE DISPLAY TERMINALS** 1 SEC
  - \* ENGINEERING UNIT DATA
  - \* LIMITED AMOUNT OF CALCULATED DATA } ENGINE HEALTH & SET POINT VALIDATION
  - \* UP TO 250 PREDEFINED PAGES/64 PARAMETERS PER PAGE
- **ACQUIRED DATA (DATA POINT) - STEADY STATE** <1 MIN
  - \* ENGINEERING UNIT DATA (2000+ CHANNELS)
  - \* CALCULATED PERFORMANCE DATA
  - \* MATH MODEL ADJUSTMENTS/COMPARISONS
  - \* DATA DOWNLOADED TO ANALYSIS TERMINALS AS WELL AS PRINTED
  - \* DATA AVAILABLE FOR ELECTRONIC TRANSMITTAL OFF-BASE
- **ACQUIRED DATA POINT (DATA POINT) - TRANSIENT** <2 MIN
  - \* ENGINEERING UNIT DATA
  - \* CALCULATED DATA
  - \* DOWNLOADED TO ANALYSIS TERMINALS
  - \* ELECTRONIC TRANSMITTAL NORMALLY OFF-LINE

# DATA PROCESSING & ANALYSIS TYPICAL CONFIGURATION

	NUMBER OF PARAMETERS	PROCESSING RATE (SAMPLES/SECOND)		DATA POINT LENGTH (SEC)
		ON LINE	OFF LINE	
<b><u>STEADY STATE DATA</u></b> (TYPICAL)				
ENGINEERING UNITS PERFORMANCE MATH MODEL (2 MAXIMUM)	*1,700 5,000 <u>250</u> 6,950			
		STEADY STATE DATA AVERAGED TO ONE SAMPLE PER PARAMETER FOR PROCESSING		
<b><u>TRANSIENT DATA</u></b> (LOW SPEED TRANSIENT)				
ENGINEERING UNITS PERFORMANCE MATH MODEL (4 MAXIMUM)	250 200 <u>200</u> 650	20 20 20	200 200 200	VARIABLE VARIABLE VARIABLE
<b><u>DYNAMIC DATA</u></b> (HIGH SPEED TRANSIENT)				
VIBRATIONS HIGH RESPONSE PRESSURES DYNAMIC STRAIN GAGES	226			ON LINE MONITORING OFF LINE PROCESSING

\* 688 AERODYNAMIC (EXPANDABLE TO 2000 PARAMETERS)  
1052 GENERAL PURPOSE (PRESSURES, TEMPERATURES, ETC.)  
32 SPEED/FLOW

## KEY FEATURES OF THE CDAPS

- CONTINUOUS RECORDING OF STEADY STATE DATA
- SAMPLING RATES VARIABLE PER CHANNEL:  
FROM 10 TO 200 SAMPLES PER SECOND
- OVER 2000 SAMPLES MAY BE ACQUIRED IN A DATA POINT
- UP TO 40 NEAR REAL TIME OPERATIONS DISPLAYS AVAILABLE
- INTERACTIVE WORKSTATION ACCESS TO ON-LINE PERFORMANCE  
DATA, PRIOR TEST PERFORMANCE DATA AND PRE-TEST  
PERFORMANCE PREDICTIONS
- ON-LINE DIGITAL DISTORTION ANALYSIS CAPABILITY
- INTEGRATED DATA FROM ENGINE AIRFRAME DATA BUS
- DATA SECURITY
- REDUNDANCY FOR BACKUP SUPPORT

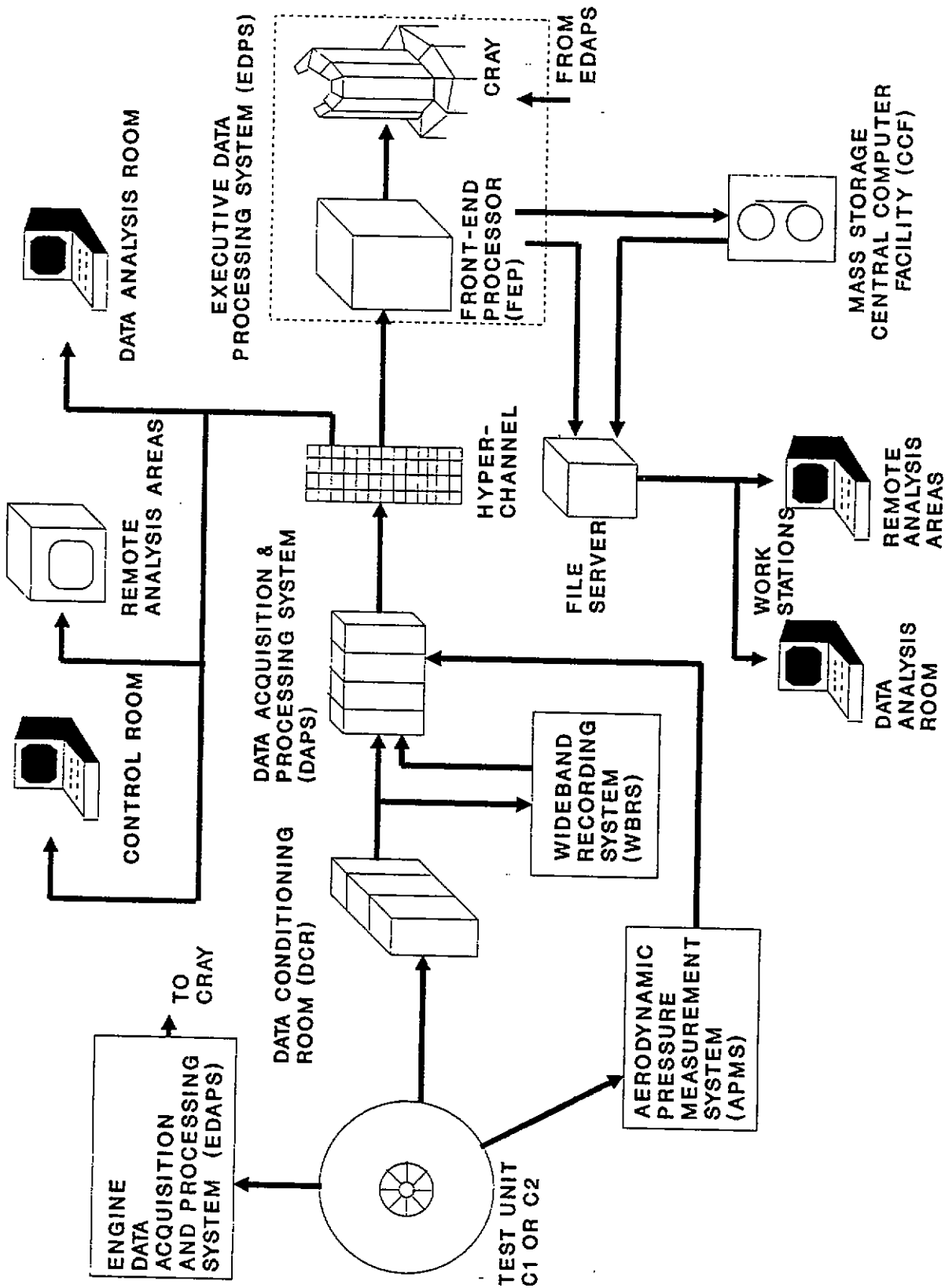

# STEADY STATE AND TRANSIENT DATA FLOW



# Aerodynamic Pressure Measuring System

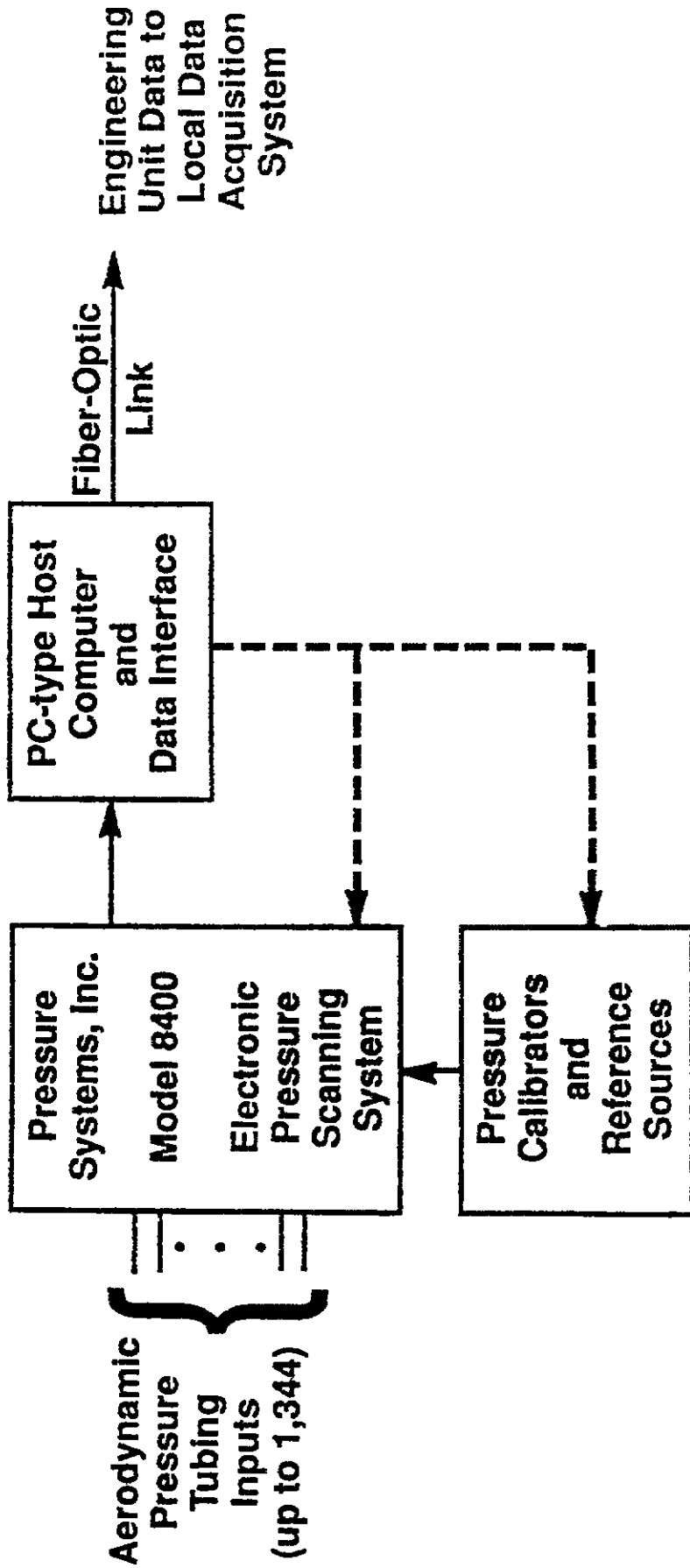

# TYPICAL C-CELLS TURBINE ENGINE TEST STEADY STATE MEASUREMENT UNCERTAINTIES

PARAMETER	MEASUREMENT RANGE	BIAS B	PRECISION S	UNCERTAINTY <sup>1</sup> U=(B+t <sub>95</sub> S)
<u>PRESSURE SYSTEM</u>				
AERODYNAMIC PRESSURE MEASUREMENT SYSTEM (IN PLACE CALIBRATED)				
ABSOLUTE (VACUUM REF.)	.5 to 5 psia 1 to 10 psia 1 to 15 psia	± .007 psi ± .0075 psi ± .008 psi	± .0006 psi ± .0012 psi ± .0018 psi	± .008 psi ± .010 psi ± .012 psi
DIFFERENTIAL (AMBIENT REF.)	1 to 29.2 psia 2.5 to 64 psia 5 to 114 psia 14.2 to 214 psia 14.2 to 514 psia	± .0078 psi ± .013 psi ± .026 psi ± .062 psi ± .130 psi	± .0036 psi ± .006 psi ± .012 psi ± .024 psi ± .060 psi	± .015 psi ± .025 psi ± .05 psi ± .10 psi ± .25 psi
DIFFERENTIAL (FLOATING REF.)	.5 to 5 psia 1 to 10 psia	± .007 psi ± .0126 psi	± .0006 psi ± .0012 psi	± .008 psi ± .015 psi

**NOTES:** 1. The uncertainty values in percent reading (Rd) are applicable over 10% to 100% of the sensor range except for the shunt calibration pressure systems which are applicable over 20% to 100% of the sensor range.

REVISED 12/17/91

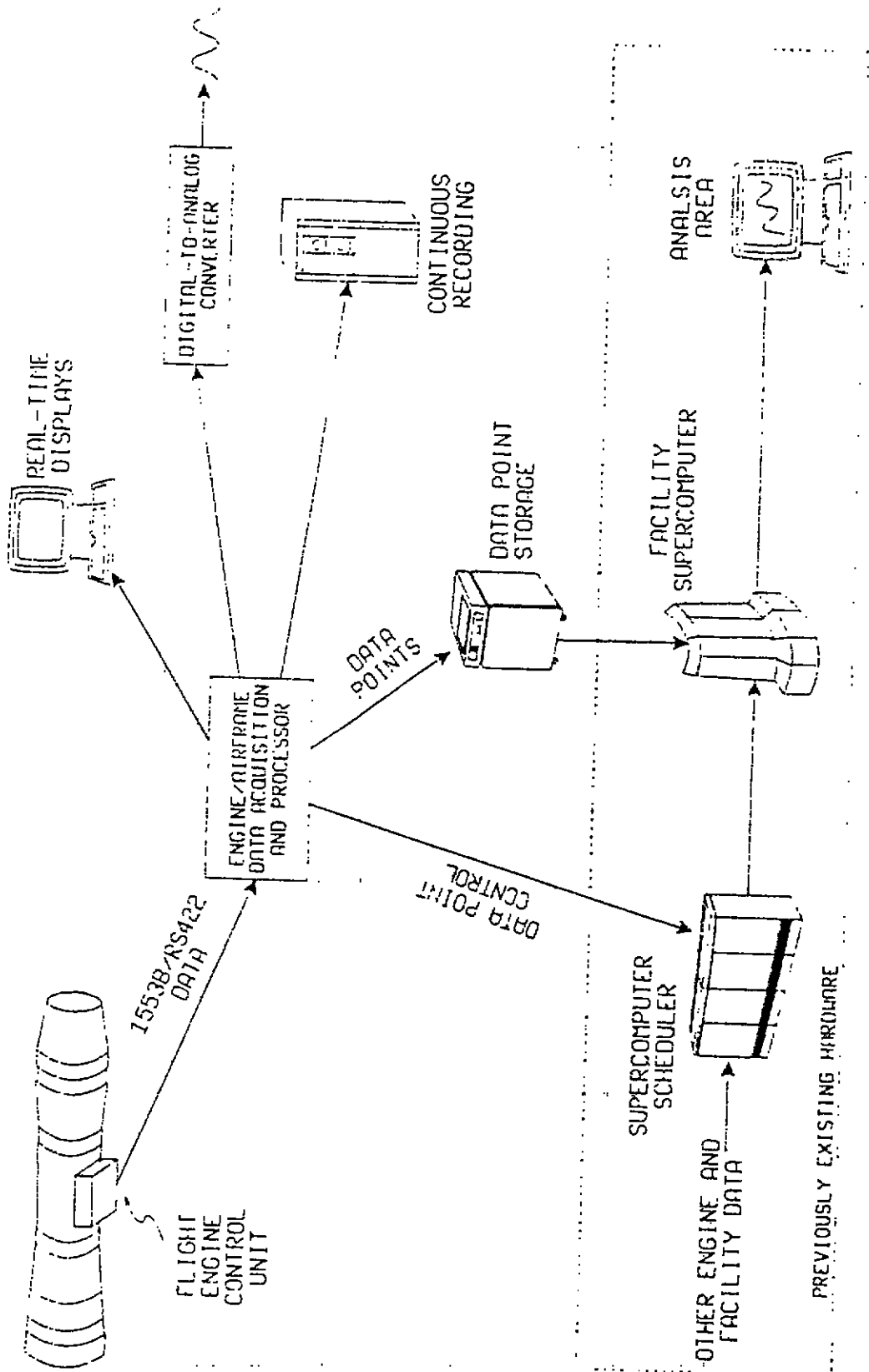

**EDAPS BLOCK DIAGRAM**

# TIME LINE FOR EDAPS CONCURRENT PROCESSING MERGED EDAPS AND WITH STATIC DATA

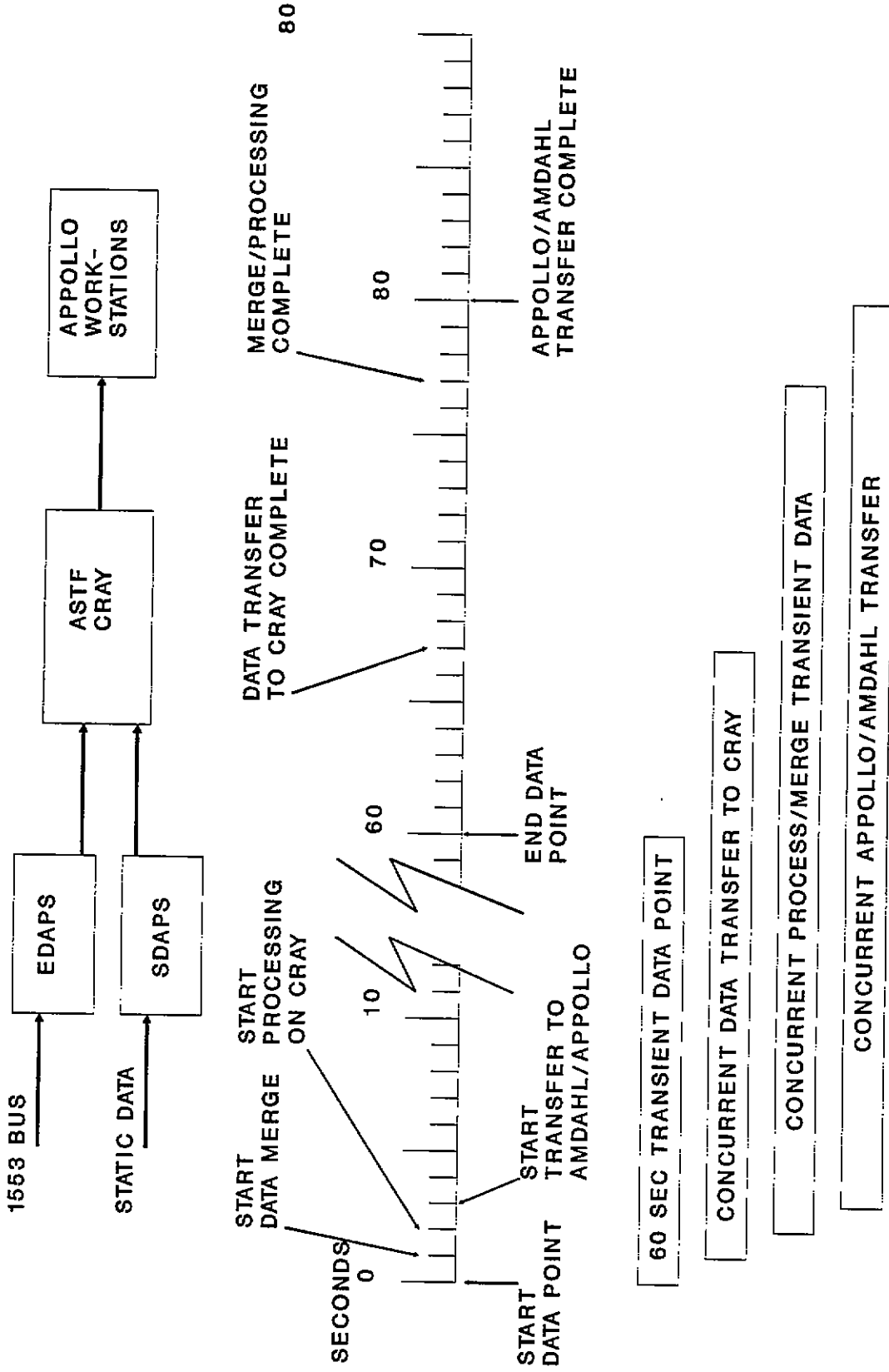



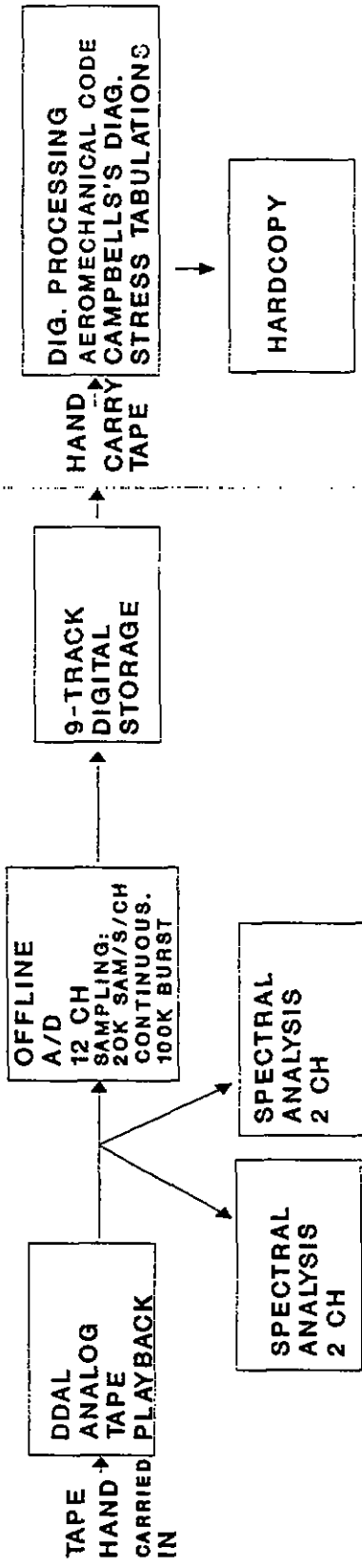

DIGITAL PROCESSING  
ON MAINFRAME  
COMPUTER

DYNAMIC DATA ANALYSIS LABORATORY

# OFF-LINE DYNAMIC DATA PROCESSING

# AEDC CENTRALIZED/TIME-SHARED ON-LINE DIGITAL DISTORTION ANALYZER SYSTEM

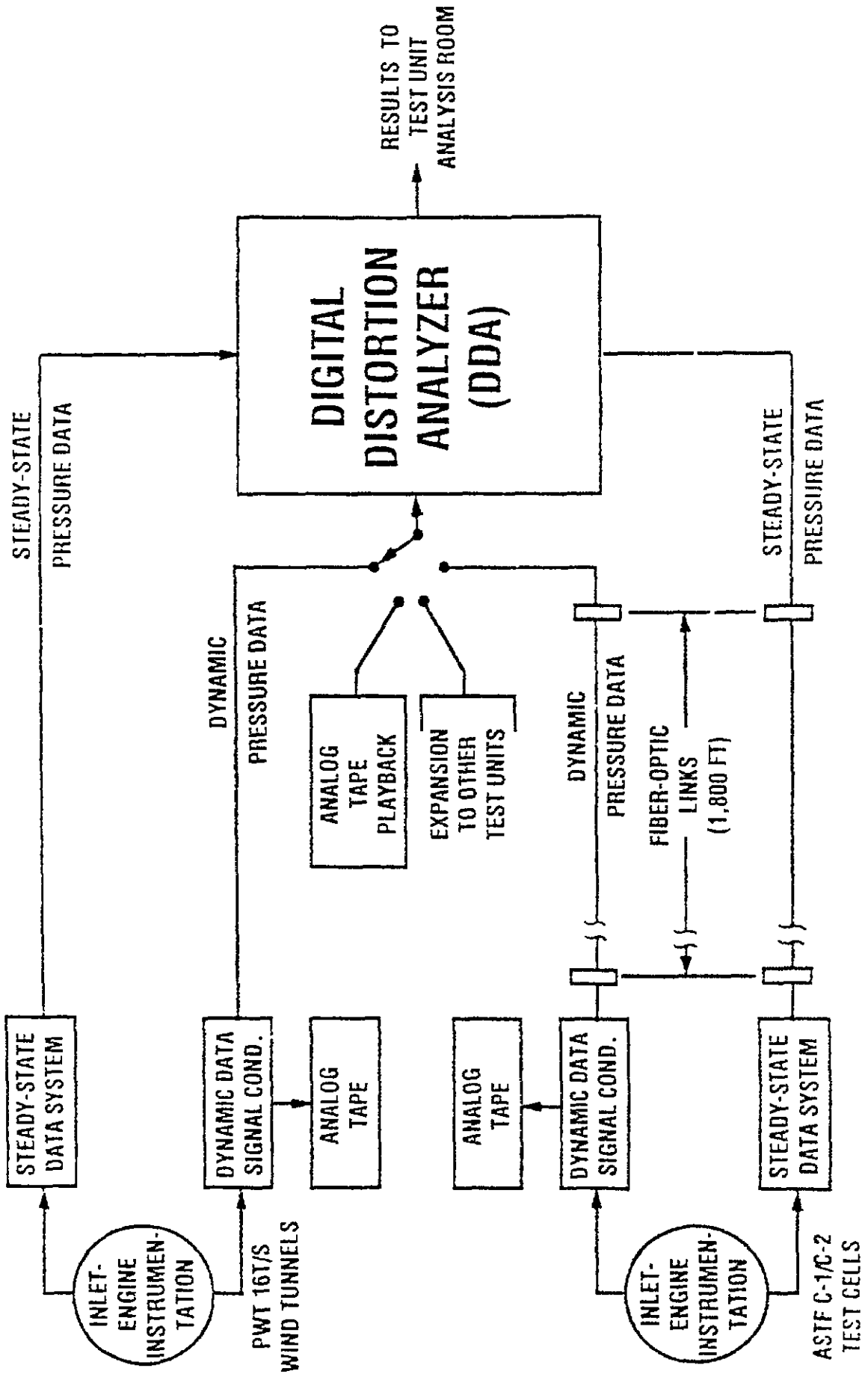

## DIGITAL DISTORTION ANALYZER SYSTEM

- PROVIDES ON-LINE DYNAMIC DISTORTION ANALYSIS SUPPORT FOR ENGINE INLET TESTING
- 64 DYNAMIC DATA INPUT CHANNELS
- 640,000 SAMPLES-PER-SECOND
- DATA POINT PROCESSING RATE IS LESS THAN 3 X REAL TIME ( A 60 SECOND DATA POINT WILL TAKE LESS THAN 180 SECOND TO PROCESS)



# DATA ANALYSIS SYSTEMS

- GRAPHIC ANALYSIS WORKSTATIONS
  - 35 APOLLO DN3500 SERIES WORKSTATIONS/FILE SERVER
  - LOCATED IN 10 SEPARATE ANALYSIS ROOMS
  - UNIX-BASED SYSTEMS
  - OFF-LINE ANALYSIS
- DYNAMIC DATA ANALYSIS LABORATORY
  - XONIC/DEC PDP-11 12 CHANNEL ANALOG-DIGITAL  
CONVERSION SYSTEM
  - SPECTRAL DYNAMICS/PDP-11 DUAL-CHANNEL  
SERIES ANALYZER

**C-CELLS NEAR REAL-TIME DATA PROCESSING  
SHORTFALLS**

- **40,000 SAMPLE-PER-SECOND ON-LINE PROCESSING LIMIT**
- **DATA TRANSMISSION TO CUSTOMER TAKES OVER 12 HOURS FOR ONE TEST PERIOD**
- **TRANSIENT PERFORMANCE DATA NOT AVAILABLE IN REAL TIME**
- **REAL-TIME DATA AND OFF-LINE PERFORMANCE DATA NOT AVAILABLE AT THE SAME WORKSTATION**
- **ON-LINE ANALYSIS CAPABILITY OF DYNAMIC DATA IS LIMITED**
- **EXCESSIVE DYNAMIC DATA TURNAROUND TIME**

# PLANS FOR THE FUTURE

# Current Propulsion Testing SS/Transient Test Data Acquisition/Processing Systems Overview

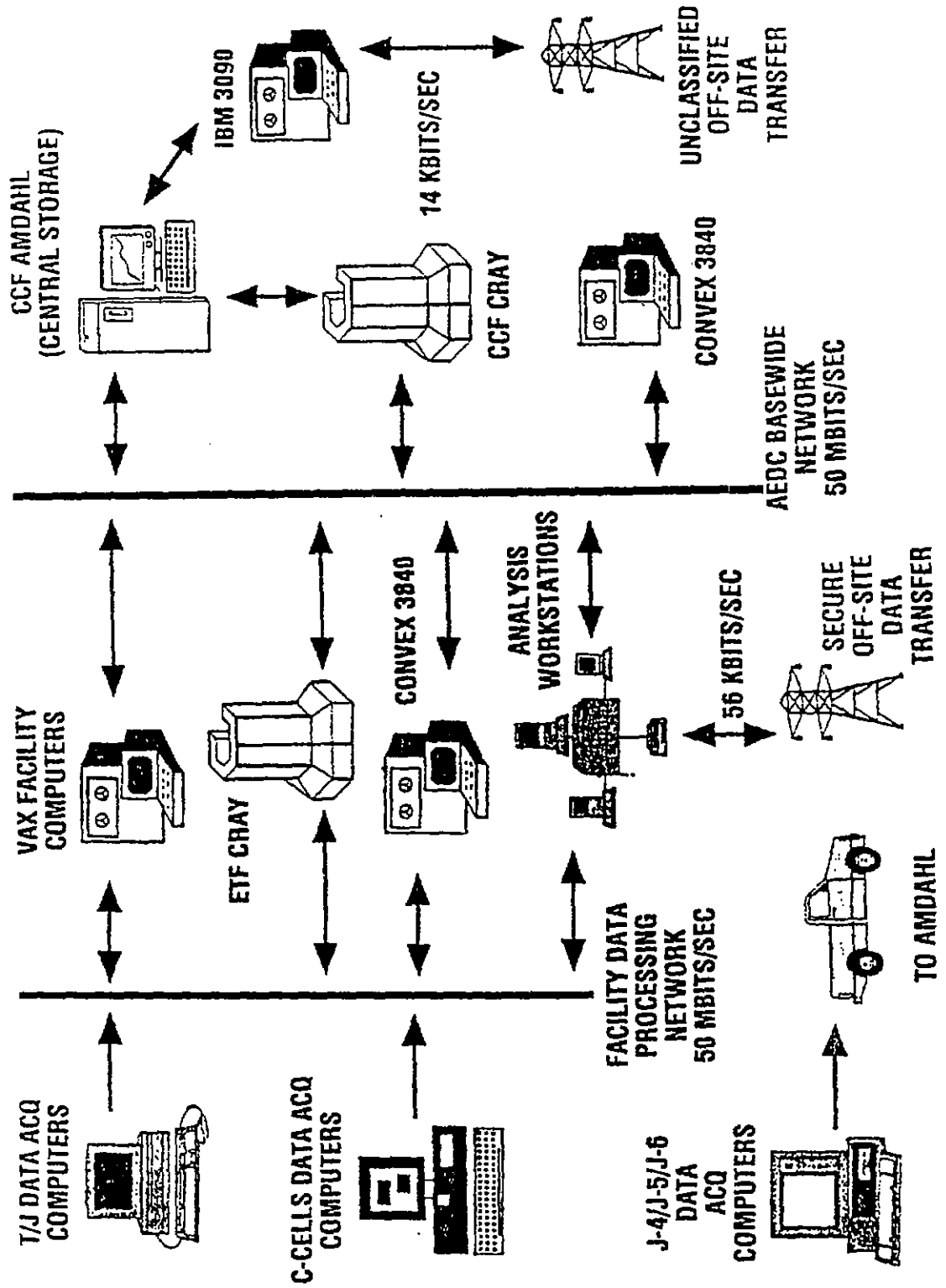

# CURRENT ETF SS/TRANSIENT TEST DATA ACQUISITION/PROCESSING SOFTWARE (OVERVIEW)

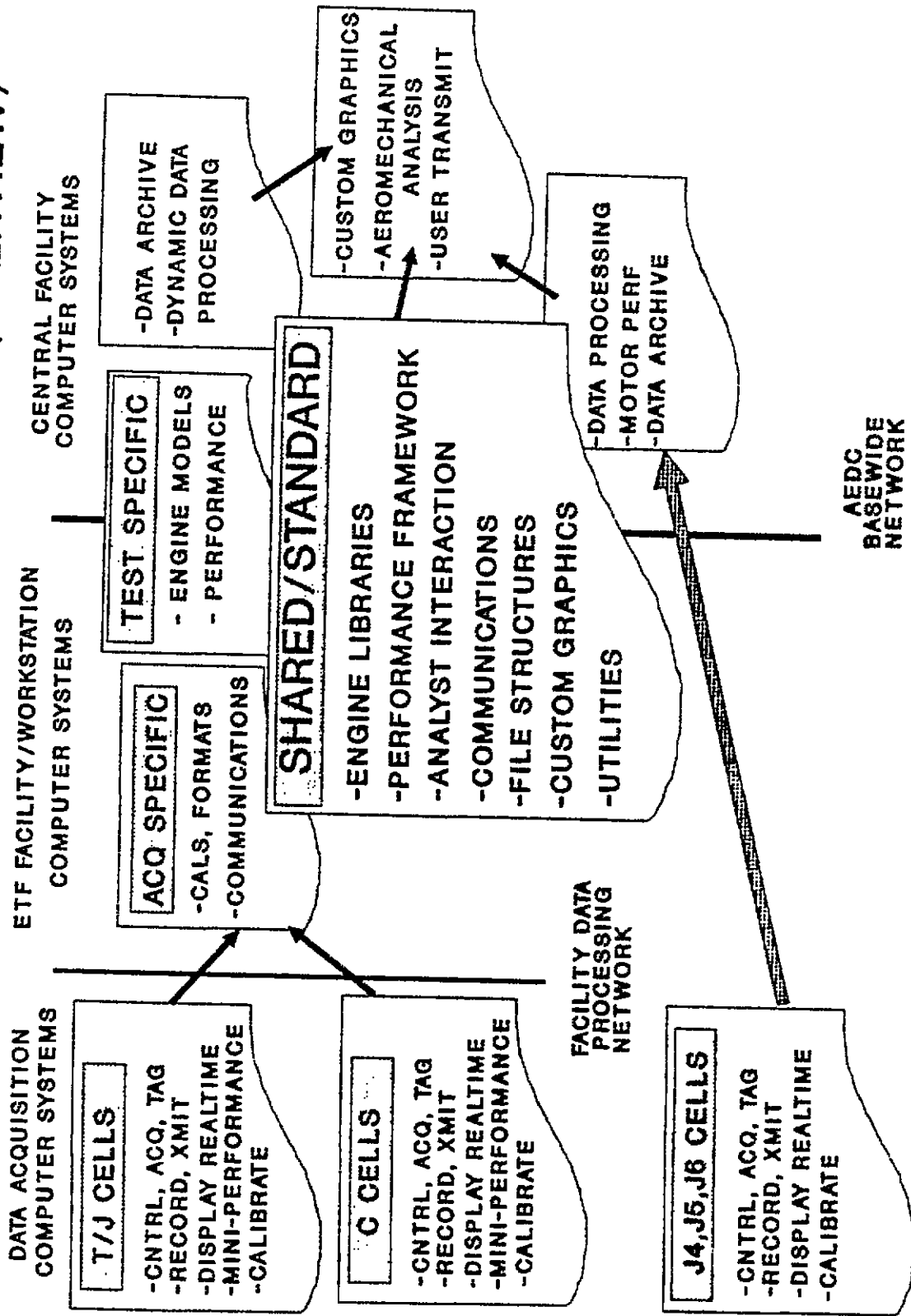

# MID-TERM SS/TRANSIENT DATA SYSTEMS CONFIGURATION

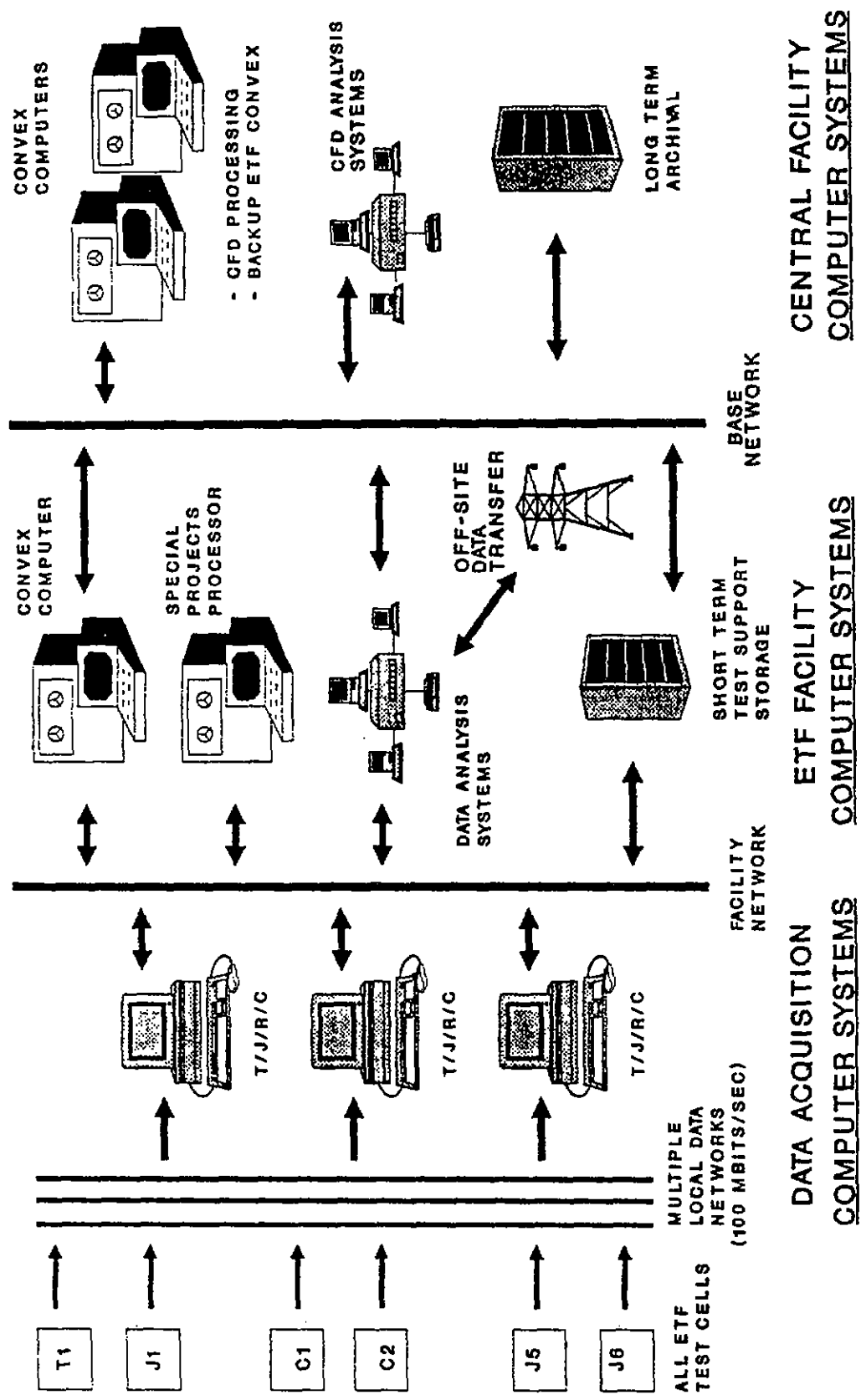

DATA ACQUISITION COMPUTER SYSTEMS  
 ETF FACILITY COMPUTER SYSTEMS  
 CENTRAL FACILITY COMPUTER SYSTEMS

# MID-TERM SS/TRANSIENT DATA SOFTWARE CONFIGURATION

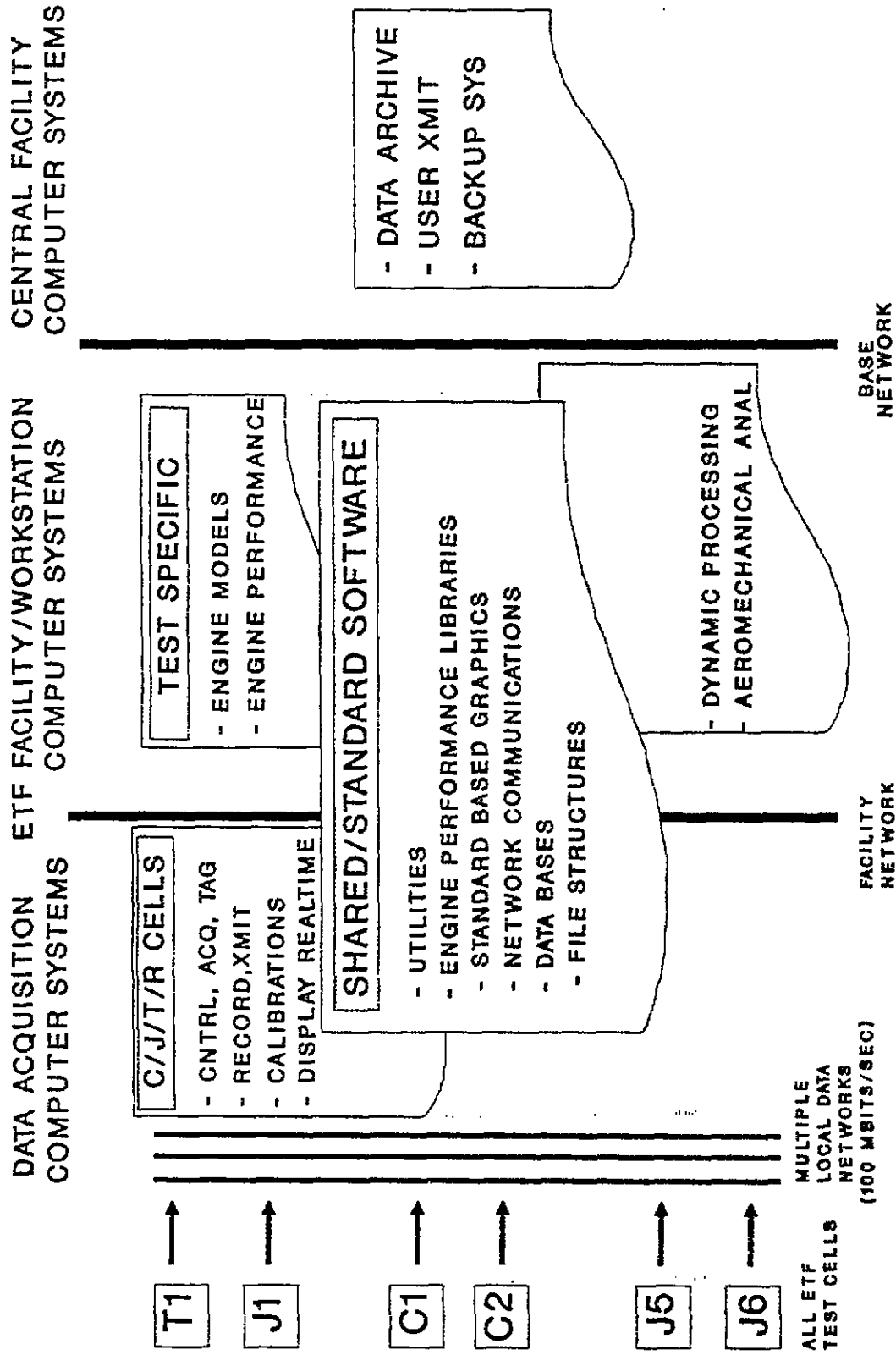

## KEY STEPS IN ACHIEVING MID-TERM SYSTEMS CONFIGURATION

- COMPLETE 1. C-CELLS DISPLAY SYSTEM REPLACEMENT
- 2. C-CELLS CONTROL ROOM SEPARATION AND TUSS  
INSTALLATIONS  
COMPLETE - C1 JANUARY 1993 FOR F119 PROGRAM  
IN-PROGRESS - C2 FY94 FOR TRENT PROGRAM
- IN-PROGRESS 3. INSTALL CONVEX COMPUTER IN ETF AND TRANSITION  
INTO ROUTINE OPERATIONS  
FY94 4. DISCONTINUE USE OF ASTF CRAY FOR TEST SUPPORT
- IN-PROGRESS 5. UPGRADE ANALYSIS WORKSTATIONS AND COMMUNICATIONS  
NETWORK (ONE AREA COMPLETE IN FY93)
- IN-PROGRESS 6. IMPROVE OFF-SITE ON-LINE DATA TRANSMISSION  
CAPABILITY (ONE AREA COMPLETE IN FY93)  
FY94 7. CONSOLIDATE FACILITY COMPUTER OPERATIONS  
FY95 8. PROVIDE LOCAL NETWORK MASS STORAGE



**KEY STEPS IN ACHIEVING MID-TERM  
SYSTEMS CONFIGURATION - CONT.**

- FY93-FY97 9. UPGRADE DATA ACQUISITION SYSTEMS
  - UPGRADE THREE COMPLEXES
  - INTERFACE TO CONVEX
  - CONSOLIDATE COMPLEXES
  
- FY94 10. TRANSFER FACILITY VAX COMPUTER FUNCTIONS  
TO CONVEX OR WORKSTATIONS
  
- FY94 11. DISCONTINUE USE OF FACILITY COMPUTERS
  
- 12. PROVIDE CAPABILITY FOR ON-LINE PROCESSING  
OF DYNAMIC DATA.
  - PHASE I - FY93
  - PHASE II- FY96

# LONG RANGE INTEGRATED SS/TRANSIENT/DYNAMIC DATA SYSTEMS CONCEPT (TYPICAL OF ALL TEST UNITS)

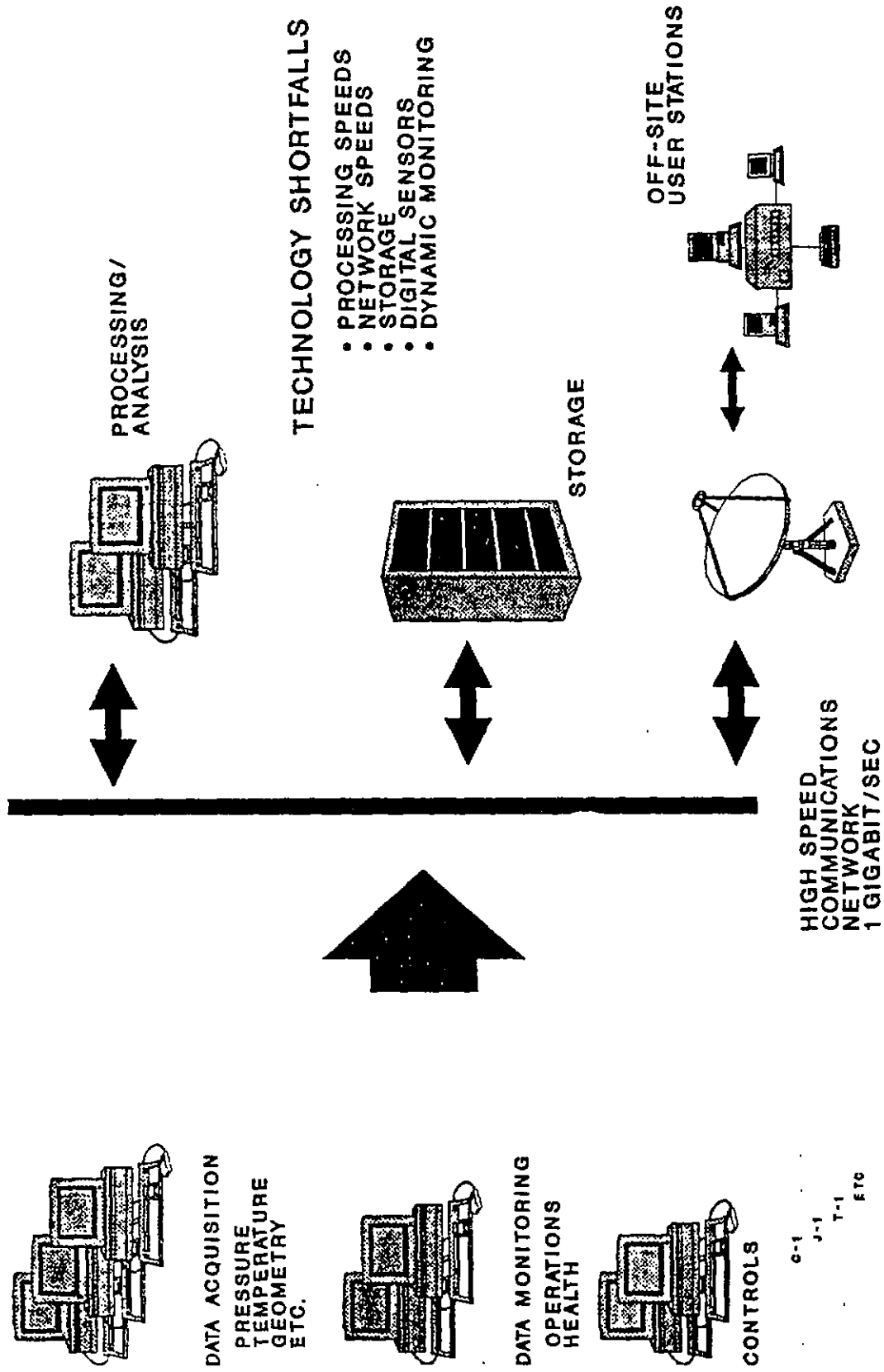

## **KEY STEPS IN ACHIEVING LONG-RANGE SYSTEMS CONFIGURATION**

- **PROVIDE UNCLASSIFIED PROCESSING CAPABILITY FOR UNCLEARED CUSTOMERS**
- **REPLACE SIGNAL CONDITIONING AND OTHER AGING EQUIPMENT**
- **CONSOLIDATE AND UPGRADE ETF A/B/C PLANT CONTROLS**
- **INSTALL TUSS SYSTEMS IN J3/J4/J5**
- **INSTALL VERY HIGH SPEED DATA NETWORKS**
- **INSTALL DISTRIBUTED ACQUISITION SUBSYSTEMS**
- **REPLACE ANALOG DYNAMIC DATA ACQUISITION/RECORDING SYSTEMS  
WITH DIGITAL SYSTEMS**
- **INTEGRATE SS/TRANSIENT/DYNAMIC PROCESSING/ANALYSIS SYSTEMS**

# CURRENT UPGRADE EFFORTS

# Current Propulsion Testing SS/Transient Test Data Acquisition/Processing Systems Overview

## Overview

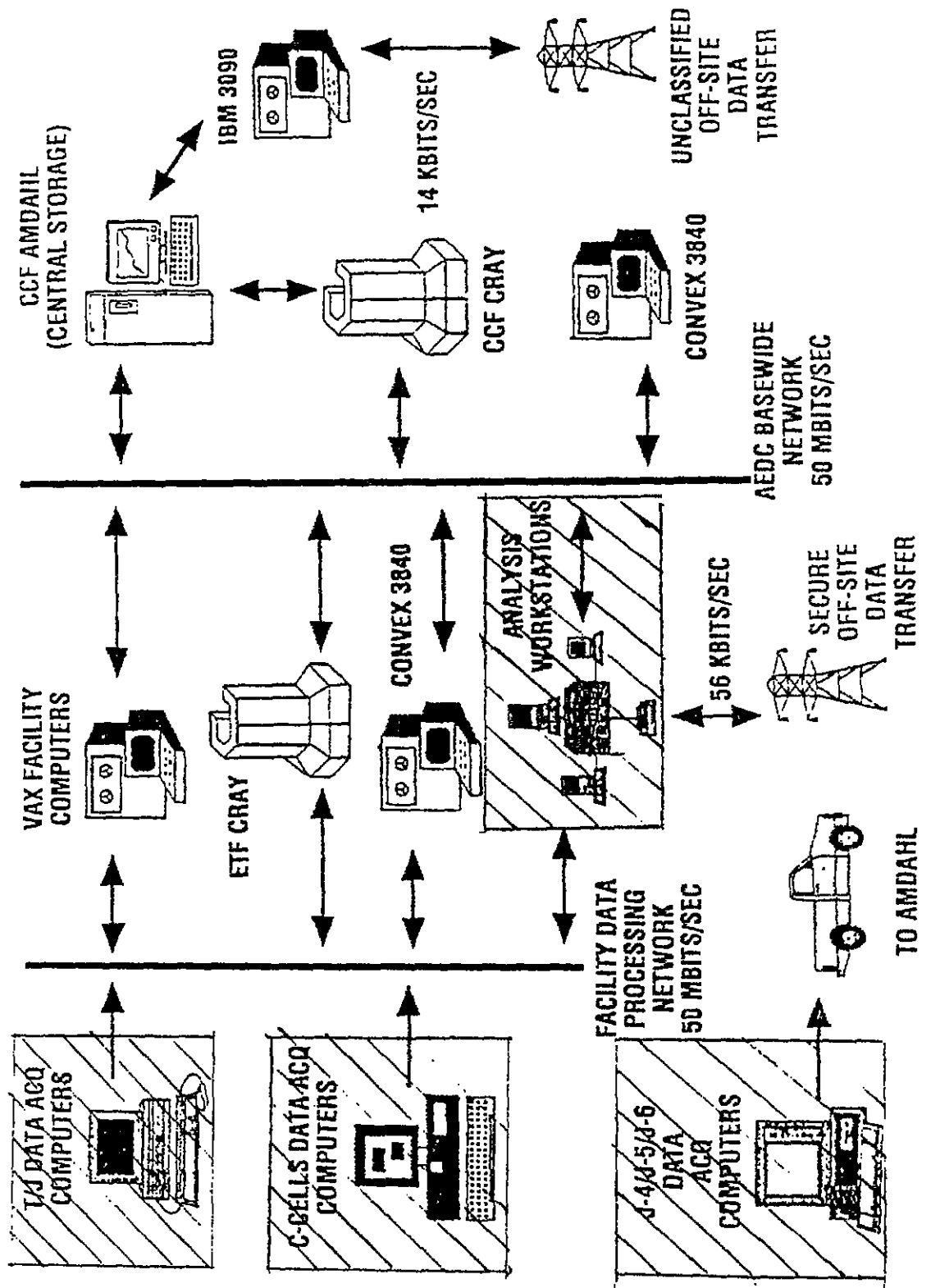

# CONSOLIDATED FRONT-END SOLUTION

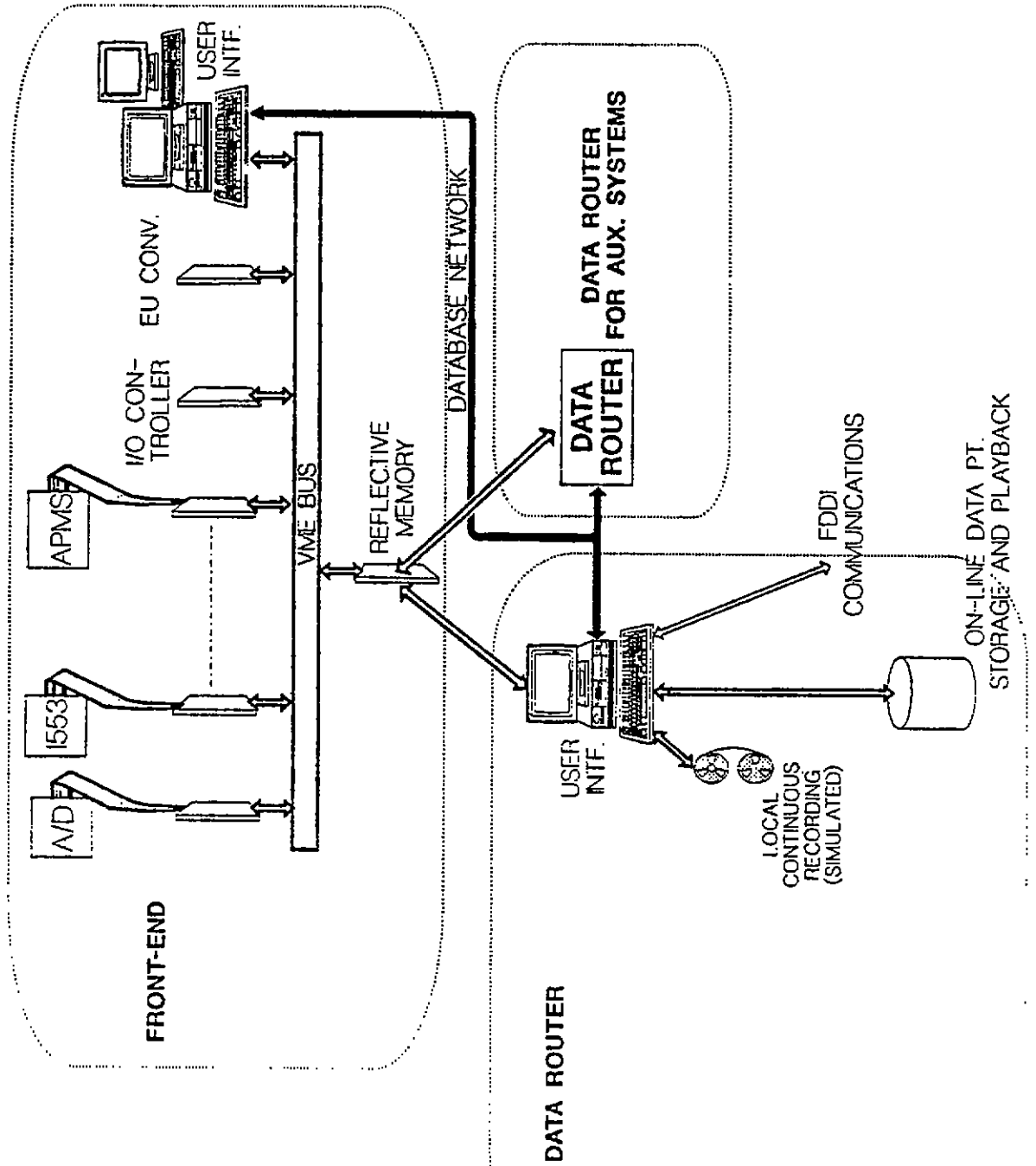

# DISTRIBUTED FRONT-END SOLUTION

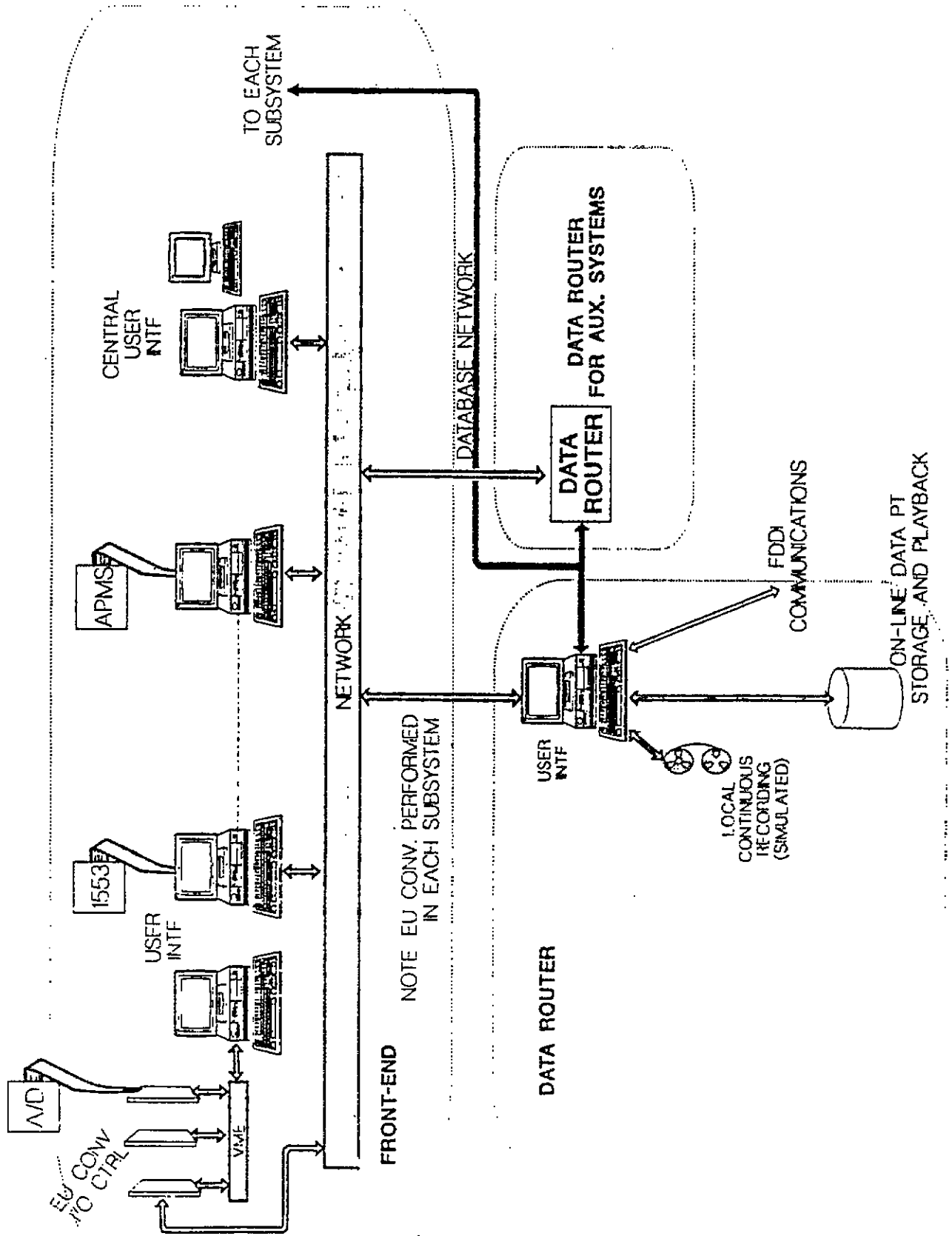

# PRESENT DESIGN CONCEPT

SCALEABLE DESIGN -- CAN BE EXPANDED OR DOWNSIZED TO ECONOMICALLY SUPPORT ANY TEST CELL, C1 DOWN TO R1A1

- FRONT-END, ACQUIRES DATA
  - \* STANDALONE/DEDICATED TO A TEST CELL
  - \* VMEbus BASED
  - \* PLUG & PLAY DATA SOURCES CONFIGURABLE FOR EACH TEST CELLS REQUIREMENTS
  - \* I/O CONTROLLER - CONTROLS ACQUISITION OF DATA
  - \* 1st LEVEL ENGINEERING UNIT CONVERSION
  - \* USER INTERFACE - SUPPORTS LOCAL CONTROL & OPERATIONAL ACTIVITIES
- DATA RECORDING STATION
  - \* SHARED BETWEEN TEST CELLS
  - \* SUPPORTS CONTINUOUS RECORDING
  - \* DATA POINT RECORDING/PLAYBACK
  - \* TRANSMITS DATA TO DATA PROCESSING COMPUTERS
  - \* USER INTERFACE - PROVIDES SYSTEM CONTROL AND STATUS DURING TEST
- DATA ROUTER, DISTRIBUTES REAL-TIME DATA TO DISPLAYS AND OTHER AUXILIARY SYSTEMS
  - \* 2nd LEVEL ENGINEERING UNIT CONVERSION
  - \* INTERFACE TO AUXILIARY SYSTEMS (TUSS, CADDMAS)
  - \* USER INTERFACE - PROVIDES;
    - \* CONTROL AND DISPLAY OF REAL-TIME GRAPHICS
    - \* INTERFACE TO INFORMATION SYSTEMS (INSTRUMENT BOOK, AIMS)
    - \* ACCESS TO REAL-TIME VIDEO
    - \* ACCESS TO PROCESSED DATA



# REQUIREMENTS OVERVIEW

- AGGREGATE DATA RATE: 500 ks/s
- ACQUIRE DATA FROM VARIOUS ASYNCHRONOUS SOURCES:  
IEEE-488  
1553  
ARINC-429  
APMS  
RS422  
ETHERNET
- REPLACE ALL ETF DATA ACQUISITION SYSTEMS WITH ONE COMMON PLUG & PLAY DESIGN, EASILY CONFIGURABLE FOR THE NEEDS OF EACH SPECIFIC TEST CELL.
- REAL-TIME EU CONVERSION
- CONTINUOUS RECORDING OF ALL DATA
- ON-LINE TRANSMISSION OF DATA PTS TO PROCESSING COMPUTERS
- SUPPORT AUXILIARY SYSTEMS WITH EU DATA: TUSS, DISPLAY SYSTEM, CADDMAS, CONTROL SYSTEMS
- SUPPORT OPERATIONAL NEEDS; (CHECKOUT ACTIVITIES))
- INCORPORATE OPEN SYSTEM STANDARDS, OFF-THE-SHELF HARDWARE AND SOFTWARE WHERE POSSIBLE

# TYPICAL ETF ANALYSIS AREA

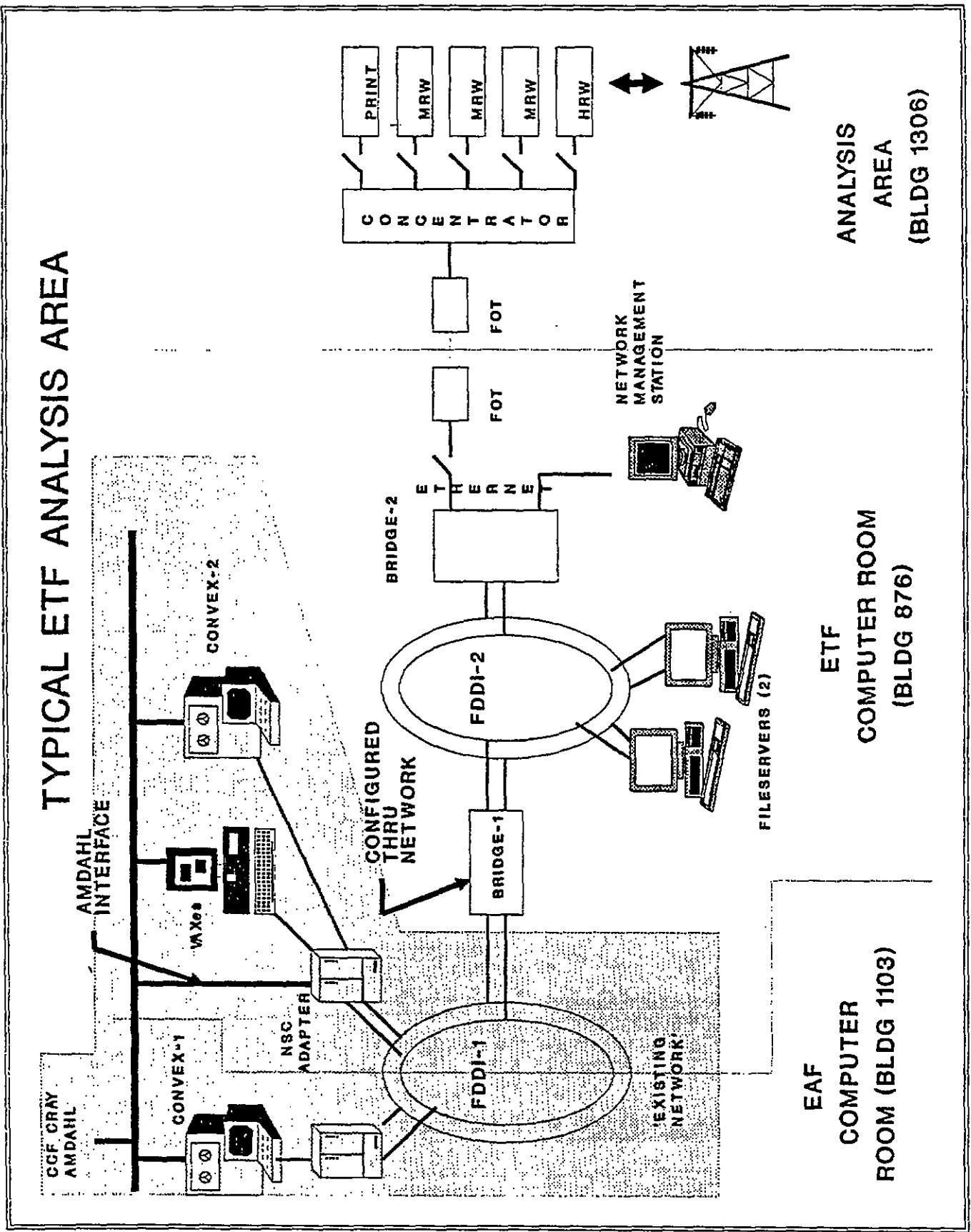

# CUSTOMER SATISFACTION

- LONG TERM CUSTOMERS
- ON-BASE REPRESENTITIVES
- INVOLVED IN DEVELOPMENT OF DATA SYSTEM REQUIREMENTS
- LONG TERM ALLIANCES
- AEDC SPONSORED CUSTOMER DAYS
- OVERALL CUSTOMERS ARE PLEASED WITH DATA TURNAROUND AT AEDC



# Data Visualization

# Test Data Visualization

An Analytical Tool  
for  
Data Reduction and Analysis

**PRESENTED BY:**

JERRY TAYLOR  
CODE C3251

**WRITTEN BY:**

TOMAS BOZACK  
CODE C3252



# Data Visualization

## Definition

Visualization is the use of computer graphics technology to describe physical phenomena.

- Visualization uses graphical characteristics such as:
  - Color
  - Motion
  - Three Dimensions
  - Lighting and Shading
  - Transparency
  - Translucency



# Data Visualization

## Capabilities

Visualization is used to describe complex data sets in a way that is easily interpreted by a human observer/analyst.

- Visualization can:
  - Combine data from multiple sources
  - Represent complex abstract data in a simple form
  - Show physical phenomena that cannot be directly observed
  - Provide visual form to mathematical constructs
  - Provide a simplified representation of complex phenomena



# Data Visualization

## Applications

- **Mathematics**
  - Chaos Theory
  - Topology
- **Physics**
  - Meteorology
  - Astrophysics
- **Engineering**
  - Computational Fluid Dynamics
  - Finite Element Analysis
  - Systems Engineering



# Data Visualization

## • Traditional From of Data Presentation

- Limited Number of Functions Displayed at One time
- Not Intuitive
- Not interactive

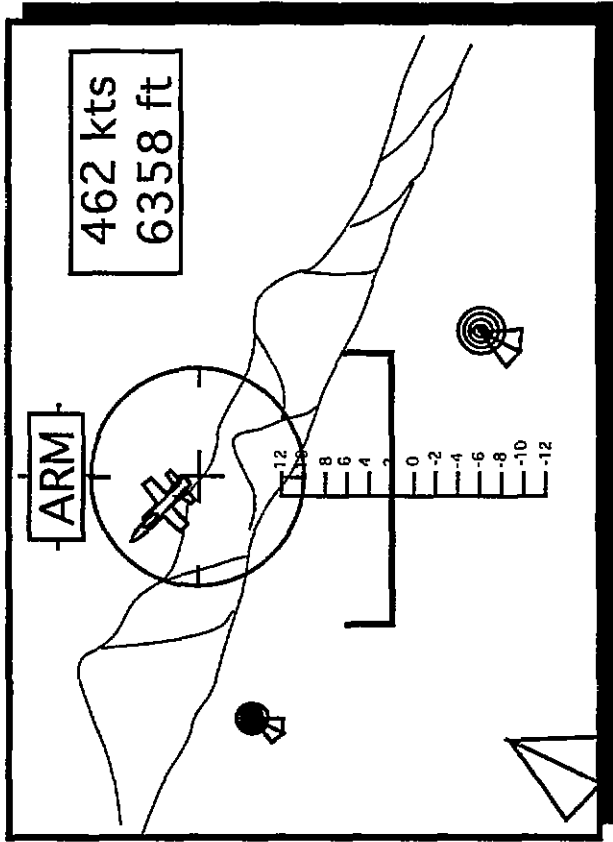
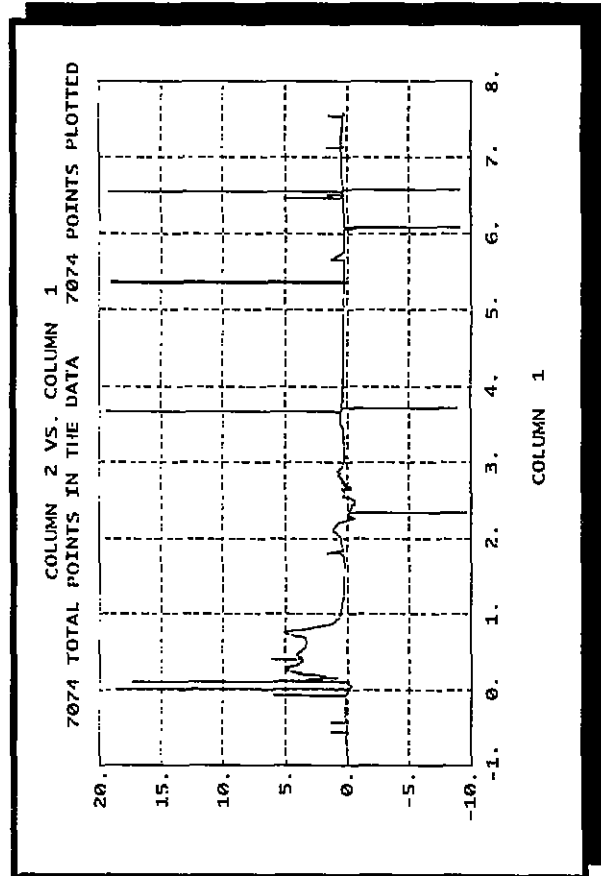

## • Visualization

- Large Number of Functions Displayed at One time
- Intuitive
- Interactive
- Extendable/Configurable





# Data Visualization

## Visualization Application

### • Antiradiation Missile Visualization

- Data Sources
  - Missile Telemetry
  - Ground Based TSPI
  - Threat Simulator Data
- Data Display
  - Flight Dynamics
  - Seeker Data
  - Guidance Data
  - Inertial Nav. Data
  - RF/ECM Environment

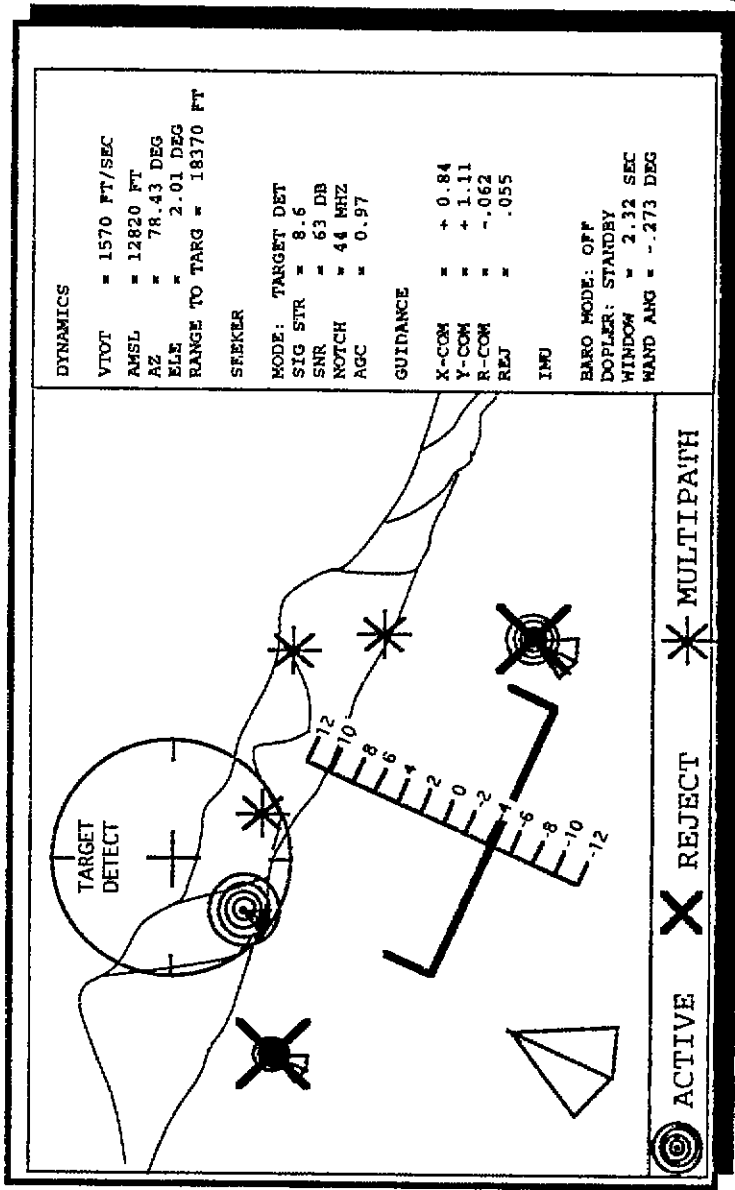



# Data Visualization

## Data Reduction and Analysis System

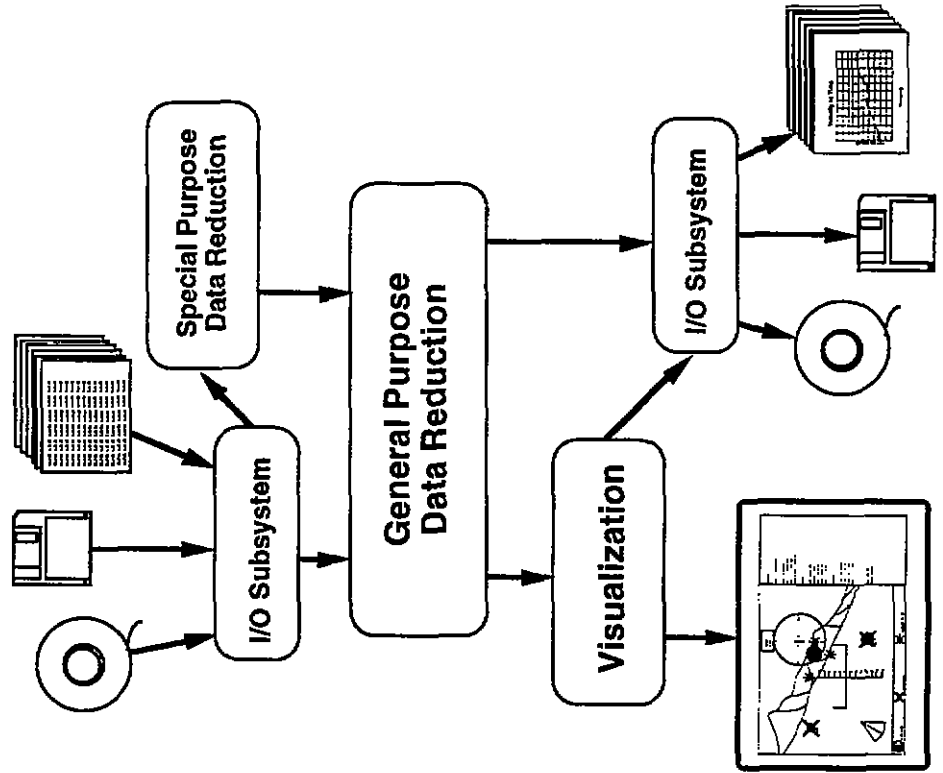



# Data Visualization

## Computing Resources

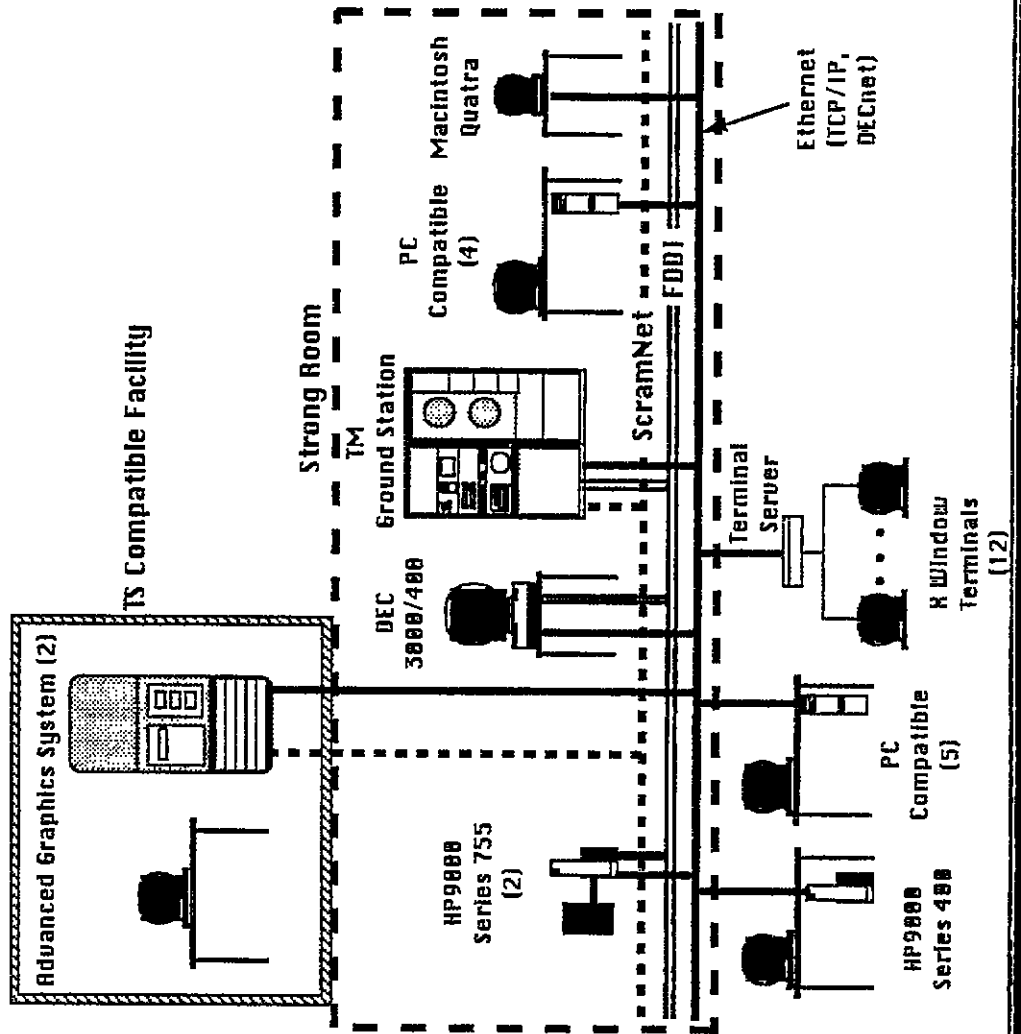

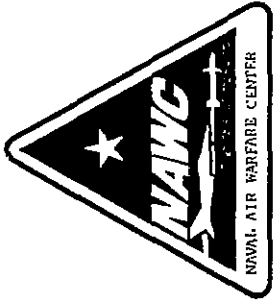

# Data Visualization

## Status

- **Visualization today.**
  - Use of standard off the shelf hardware and software products (UNIX workstations and Wave Front software)
  - Flexible but slow (up to a minute per video frame)
- **Visualization tomorrow.**
  - Multiprocessors executing customized software
  - Systems operating at real-time performance



# Data Visualization

## Demonstration Video Tape

- Missile TM Display
- Missile Trajectory and Seeker View Display
- Simulation of Bomb Release from F/A-18

# TSPI DATA PROCESSOR DEVELOPMENT

Kenneth J. Williamson

Air Force Wright Laboratory/Armament Directorate  
Eglin Air Force Base, Florida 32542

## ABSTRACT

This paper describes the concepts and philosophies used by the Wright Laboratory Armament Directorate Instrumentation Technology Branch in the development of the Time Space Position Information (TSPI) Data Processor (TDP). The TDP will provide common hardware and software for real-time Kalman filtering to be used on DoD test ranges. The design will allow for easy integration of the TDP with existing range assets.

## 1. INTRODUCTION

High accuracy Time-Space-Position-Information (TSPI) of aircraft and released munitions is essential data for all flight test programs. This data is provided by TSPI data sources (such as GPS, instrumentation radars, photo/ video-theodolites, and multilateration systems) that have unique strengths and weaknesses. It would be highly desirable to integrate all available inputs to improve data accuracy. Kalman filtering is a proven methodology for integrating data and providing optimal estimates. Because of the computational burden Kalman filtering imposes, this type of processing has traditionally been used as a post flight activity. Some real-time Kalman filter systems have utilized multiple general purpose machines; however, this is not a cost effective approach in providing optimal TSPI estimates. These large systems are not only costly to implement but the associated maintenance and facility real estate add to that cost. With the rapid increase in computational power becoming available in microprocessors, the ability to cost effectively provide real-time optimal TSPI estimates has become a reality.

The TSPI solution will support real-time evaluation of mission activities at both central and remote sites. This will improve the utilization and quality of mission time on the test range. The filter solution from integrated multiple sensors will also provide greater safety, improved system fault tolerance, and enhanced sensor slaving by the use of velocity and acceleration estimates. The TSPI Data Processor Program, created by the Instrumentation Technology branch and funded by OSD/DDRE to develop a low cost, real-time system will provide high accuracy TSPI estimates for DoD range applications.

## 2. DEVELOPMENT EFFORTS

Several concepts were initially proposed for the TSPI Data Processor. One concept was to use special purpose Very Large Scale Integrated (VLSI) chips to perform the computationally demanding parts of the Kalman filtering algorithms. Because of the high costs of complex circuit board designs and limited system flexibility, the performance improvement was not justified. These

factors conveyed the need to develop low cost systems using groups of microprocessors to achieve required performance levels. Several multi-processor configurations were considered, but the INMOS Transputer offered the higher cost-performance ratio and the ability to easily interconnect transputers for parallel processing. (Ref 1.)

The transputer, schematically illustrated in figure 2-1, is a high performance microprocessor developed by INMOS Corporation. The architecture is similar to Reduced Instruction Set Computing (RISC) microprocessors, but the presence of hardware that allows the interconnection of transputers through high speed communication links makes it unique.

These four direct memory access (DMA) communication channels act like small I/O computers supporting serial data rates of up to 20 Megabits/second. Because inter-transputer communication occurs via these DMA "links" this task does not require the use of the main processing unit. The transputer was the first microprocessor to move the floating point unit onto the same chip as the integer arithmetic unit. This architecture allows the concurrent execution of integer operations with

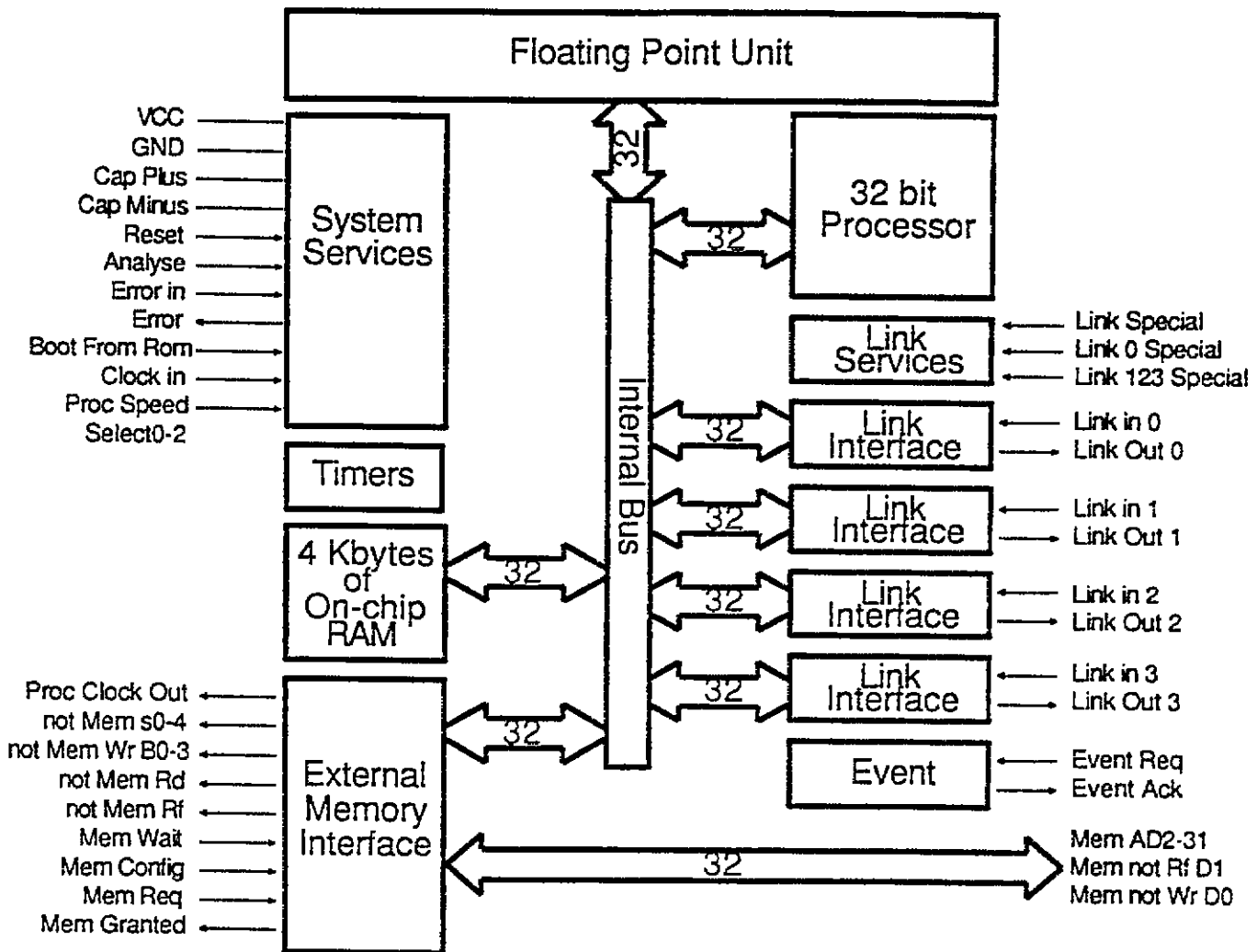

Figure 2-1. Transputer Structure

floating point operations which makes the unit perform much like an array processor. The transputer can perform scientific calculations at three to four times that of a Digital Equipment Corporations Virtual Address eXtension (VAX) model 11/780. The extreme processing power and the inter-transputer communications make possible the construction of low cost parallel processor systems that are well suited for solving Kalman filter algorithms. With these advancements in processor technology, design of a proof of principle prototype was initiated.

## **2.1 Proof of principle prototype**

Rapidly evolving transputer technology provided the opportunity to use these devices for computationally intensive tasks, which previously required the use of mainframe computers. The development of a "proof of principle prototype" was initiated to show that low cost real-time TSPI Data Processors are feasible. The system was to process real-time streams of flight test data from multiple radars and provide the real-time Best Estimate of Trajectory (BET) for display and analysis.

The Kalman filter portion of the TSPI Data Processor utilized the Multi-Station Solution (MSS) program that was used at Edwards Air Force base. The MSS program, coded in FORTRAN, is an efficient optimal estimation formulation known as the Square Root Information Filter (SRIF). Originally developed on a VAX, much of the MSS code was used without change, but additions were made to support the multiprocessor approach and the real-time, raw data characteristics. The goals of the prototype system involved porting the large MSS FORTRAN code to the transputer, interfacing the TSPI processor to a real-time data stream and implementing the system using multiple transputers.

### **2.1.1 Prototype Hardware**

The prototype TSPI Data Processor system is shown in Figure 2-2. The transputer based boards were hosted on a compatible Personal Computer Advanced Technology series (PC-AT) system that used a disk system to store the real-time program for downloading to the transputers. The PC-AT was also used to display real-time processing statistics. The first board was an interface card used to bidirectionally convert RS-232 to/from the transputer link format, which serves as the interface to the VAX. The use of the RS-232 served two functions: it minimized the modifications to the Eglin AFB Central Control Facility (CCF) system necessary for integration and demonstration; and the nature of the RS-232 standard demonstrated the general interface for other machines and communication systems. The fact that the CCF VAX hardware restricted the data transfer rate to 19.2 Kilo baud was a major disadvantage to this approach. The data transfer time at this rate would be 0.1 seconds even with two separate input lines and one output line.

The RS-232 interface card made by Computer System Architects (CSA) contains an INMOS T414 (non-floating-point transputer) connected to four serial interface chips. This design supports several modes for data transfer. This provided sufficient data transfer and increased flexibility for status and control.



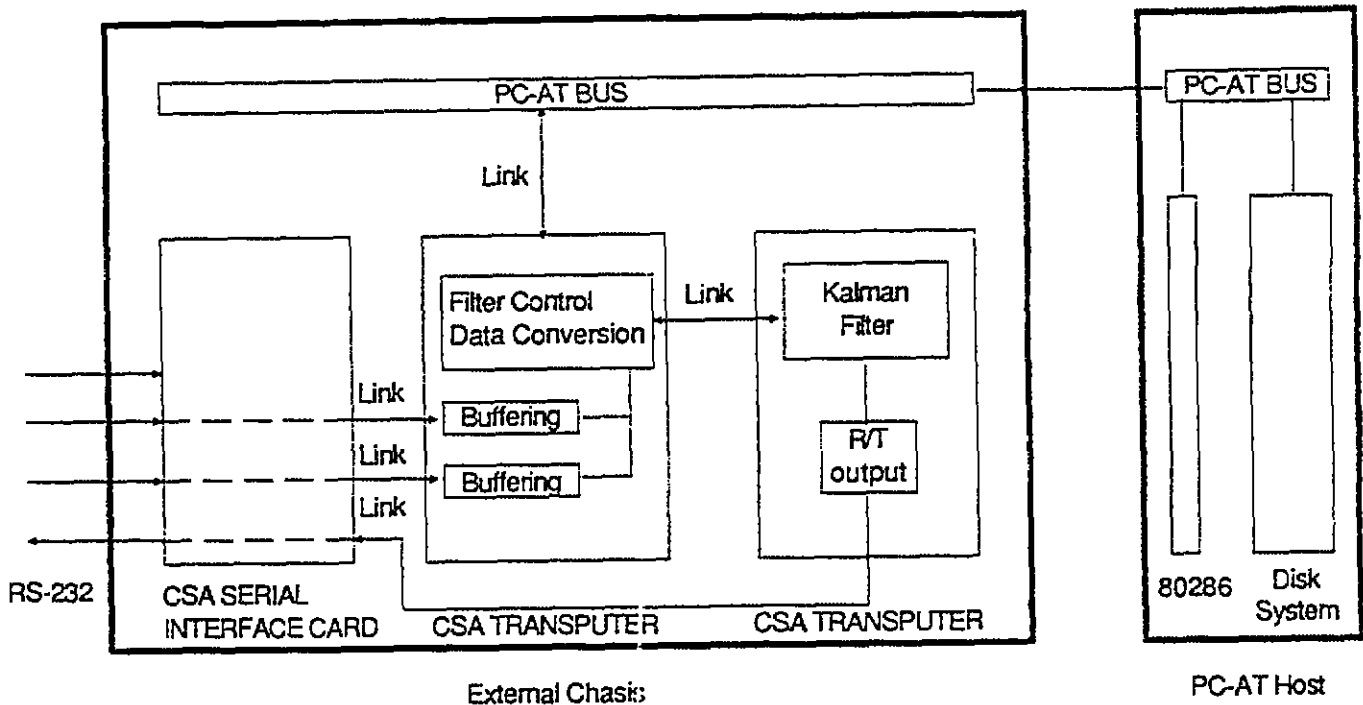

Figure 2-2. Hardware / Software Structure for Prototype System

The other two boards, also made by CSA, are identical and contain an INMOS T800 floating point transputer with 1 Megabyte of high speed memory. The transputer cards have significantly more capability than required, but each performs an important function for the optimal position estimate. The first transputer card is used for Filter Control, Data conversions and Buffering. The next transputer card is used to perform the data integration and evaluation using the SRIF algorithm, and data format for real-time output.

### 2.1.2 Prototype Software

The real-time Software utilizes multiple tasks, concurrently running on two transputers. The first transputer is running three tasks and the second transputer is running two. The description of these modules is described below.

#### 2.1.2.1 Filter Controller

The filter controller is the root of the system process. It is the only component that can communicate with the PC-AT host disk and video display. At startup the controller reads and distributes information from the disk that is used by other tasks. This data includes radar instrument locations, measurement noise estimates, weather information, pre-mission calibration corrections, and input/output parameters. Determining the source and format of input and output data is an important task for the filter controller. The flexibility of being able to change input and output options became very useful during system testing.

The filter controller performs several important run-time functions such as determining when to call the filter process. Each 0.1 second interval is seen as a frame of data and all data in the current frame is held by the controller until the first data point of the next frame. Although this approach adds latency it is a simple means of synchronizing the incoming data. The controller also checks for data dropouts and invokes the filter to provide an updated estimate even if there is no new data. The controller also uses data from the Filter task and provides auto-tuning of filter parameters to prevent solution divergence.

The prototype utilized binary format real-time radar data as inputs, which were translated into engineering units by the filter controller. The controller applies calibration and refraction corrections to the real-time data. This is accomplished by using pre-mission angle and range calibration data, along with atmospheric weather data.

### **2.1.2.2 Real-Time Buffering**

The buffering tasks support the input of real-time data via the two serial lines. The two identical tasks monitor each of the serial lines and buffer the incoming data. The rejection of incorrect data is accomplished by the buffering task checking the incoming data for sync words and their positions. This buffering was required because of the limited buffering capacity of the serial interface card.

### **2.1.2.3 Filter**

The Filter task is an extended square root information filter (SRIF) that generates optimal estimates and error covariances from TSPI measurement data. At start-up, initialization messages are sent to the filter task via the physical link connecting the two processors. These messages come from the Filter Controller and describe the instruments and the type of processing to be performed. The Filter task also provides the transmission of data messages on each call to the Filter. With a fixed time interval in measurement data of 0.1 seconds, 1000 messages were required to be sent over the link. The architecture used makes it more efficient to send small messages individually rather than use a lot of time packing and unpacking large messages. The Filter task was also responsible for passing its results to the Real-Time Output task.

### **2.1.2.4 Real-Time Output**

The Real-Time Output task extracts the desired real-time output data from the Filter task and formats it for serial output. This is accomplished by formatting the data into a record structure that contains position, velocity, uncertainty, and filter status. This task also converts the transputer floating point numbers (IEEE Format) into the VAX format. The data is then sent to the serial interface via a transputer link connecting the two boards.

## **2.1.3 Prototype Performance**

The prototype TDP was successfully interfaced and demonstrated at the Eglin Air Force Base CCF. The TDP provided real-time filtered output from five streams of 10 Hz radar data and was displayed on mission consoles for accuracy evaluation. Comparisons were made between the off-line

MSS filter and the TDP and the results showed no degradation of track accuracy by using the transputers.

System loading and data latency were also concerns to be investigated. The transputer loading was evaluated by off-line timing using embedded timers in the code. The Filter and Output transputer used about 50% of the available processor time. The Control and Buffering transputer used about 70% of the available cycles when refraction corrections were calculated, and 50% when these calculations were turned off.

The latency was measured by comparing the time tag of the solution to the time the data arrived at the source (VAX) computer. This resulted in a measurement of latency of 0.3 seconds and Table 2-1 below shows the possible causes of this latency. (Ref 2.)

VAX TO TRANSPUTER REPORT TRANSFER TIME	0.075
DATA VERIFICATION	0.025
REPORT CONTROLLER DELAY	0.05
CALIBRATION/REFRACTION CALCULATION	0.025
SRIF	0.05
TRANSPUTER TO VAX REPORT TRANSFER	0.025
VAX MULTIPROCESSING	0.025 (est)

Table 2-1. Contribution to TDP System Latency (Times in Seconds)

The TDP demonstrated that high-performance, real-time TSPI data processors can be built from transputers at extremely low costs. This success lead to the development of a higher performance Breadboard TDP system capable of supporting the integration of Global Positioning System (GPS), Radar, Multilateration and processed Theodolite data.

## 2.2 Breadboard TDP

The development of the Breadboard TDP was initiated to bring the program one step closer to a production Data Processor for DoD Test ranges. The Breadboard TDP expanded the prototype to integrate data from multiple range sensors. These sensors included: GPS, Multilateration systems, such as the Gulf Range Drone Control Upgrade System (GRDCUS) used at Eglin and future real-time theodolites. The breadboard also utilized multiple transputers and all software is coded in Ada for added maintainability. The breadboard TDP included designs to demonstrate its utility under actual flight test conditions.

### 2.2.1 Breadboard TDP Hardware

The breadboard TDP is a single PC-AT (16 bit IBM compatible) I/O card with INMOS TRANputer Module (TRAM) components. The card is capable of accepting 20 TRAMS which allows the TDP to be constructed on a single board. The breadboard TDP consists of five TRAMS identified as the Serial, Front-End, Root, Filter Core and the Givens B. The Serial TRAM is used to convert the transputer communication signals to RS-232 compatible signals. The other four TRAMS contain the latest INMOS 25 MHz T800 transputers and execute the algorithms that are functionally described in the next section. Figure 2-3 shows the interconnections between each module. The TDP is hosted on a PC compatible INTEL 386 computer (386 PC) that is used to download the code to the transputers and display filter statistics during operations.

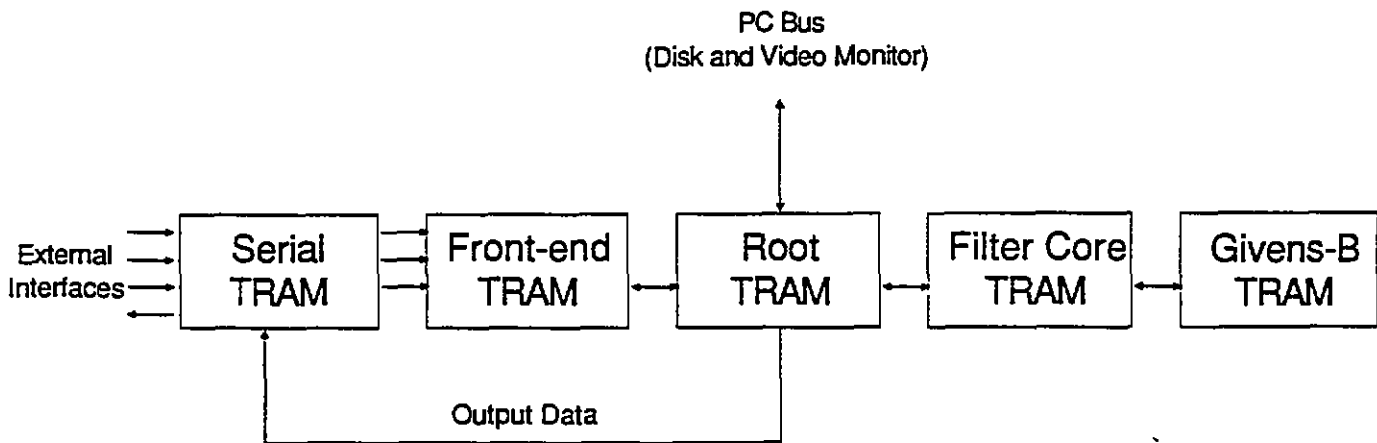

Figure 2-3. TRAM functional connections

The TDP demonstration was designed not only to show the applicability of real-time TSPI data, but show the validity and accuracy of the output data in real-time. This was accomplished by providing the real-time TDP solution to a remote site for automatically pointing a video camera at an aircraft during an actual flight test mission. The computer at the remote site (a 386 PC slaving computer) was responsible for converting the TDP solution and generating servo commands to point the video camera tracking mount.

### 2.2.2 Breadboard TDP Software

Because transputer software development tools for Ada were limited, most of the development was conducted on a 386 PC. The nature of the Ada language permitted the emulation of the multiple processors by the use of separate Ada tasks. This approach provided a means to debug major software problems and check the overall program logic. The testing of the inter-processor timing, task timing and serial I/O could not be conducted until the code was ported to the transputers. Once this was accomplished the Front-End module and the inter-transputer communications could be tested.

### **2.2.2.1 Front-End TRAM**

The Front-end TRAM hosts the module that is used to buffer the data from the Serial TRAM and performs refraction corrections, sensor coordinate and engineering unit conversions. This module must respond to incoming data with low latency to avoid loss of data from the CCF system since flow control is not used in the transfer.

### **2.2.2.2 Root TRAM**

The Root TRAM contains the module that performs many of the statistical functions for the filter. The Root TRAM also supports disk and video I/O for initialization and system diagnosis. This module calculates filter residual Sigmas, the time propagation of state estimates, state Sigmas and combines the GPS XYZ solution with the filter estimate. The health of the filter can be monitored by the statistical data that is periodically reported through the PC video.

### **2.2.2.3 Filter Core TRAM**

The Filter Core TRAM performs the large matrix operations for each filter cycle that are computationally intensive. These operations convert large matrices to an upper triangular form using the Givens formulation. With modifications to the algorithms for parallelization the operation is performed on two processors. This allows the transformations to be performed extremely quickly and is an essential part of the SRIF in the TDP.

### **2.2.2.4 Givens B TRAM**

The Givens B TRAM performs the second half of the Givens transformation as mentioned above.

## **2.2.3 Breadboard TDP Performance**

The breadboard TDP utilized a SRIF implementation, like that used in the prototype, and is very similar to the Advanced Range Data System (ARDS) filter used by Edwards AFB. This provided a means of testing the TDP for correct implementation of the algorithm by comparing results from the ARDS system. Analysis showed that all aspects (including Sigmas and error states) of the filter were correctly implemented.

The TDP system throughput was tested off-line using simulated data. Table 2-2 describes the results. The number of error states (other Biases estimated by the filter) used to calculate the optimal solution has a direct impact on the system throughput. Improvement of the system throughput may be desired for certain applications. The hardware implementation for this algorithm was optimum. Some code optimization can be implemented but further performance increase will result from the use of higher performance processors and more mature compilers. (Ref 3.)

Sensors	Error States	Throughput rate
Three Radars 4 GRDCUS Stations GPS XYZ	9 Kinematic States No Error States	12 Hz
Three Radars 4 GRDCUS Stations GPS XYZ	9 Kinematic States 10 Error States	5 Hz
Three Radars 4 GRDCUS Stations GPS XYZ	9 Kinematic States 3 Radar Error States	10 Hz
Two Radars GPS Method 3 (raw pseudo-range)	9 Kinematic States 4 Error States	9 Hz

Table 2-2. TDP Throughput results

The flight test demonstration used the real-time solution from the TDP to automatically point a remote tracking pedestal with a video camera mounted on it. The solution was sent via a microwave link to the slaving computer located at a remote test site (C-10). This computer was responsible for reading the current range time, the pedestal position, converting the solution to a local reference frame, compensating for latency in the solution and generating the error signal for the mount servo system. The slaving computer was a 386 PC that used 3 digital I/O cards and a modem to interface to the remote site data systems. Figure 2-4 shows the TDP interface connections and the data flow structure used for the demonstration. The figure shows tracking data coming into CCF and processed by the TDP where it is then sent via microwave to the tracker at site (C-10).

This demonstration was very successful and showed the TDP system providing significantly better and smoother tracking than the existing Secondary Data slaving system used at Eglin AFB. When GPS data was used, the demonstration showed that the system pointed the mount for both low and high dynamic maneuvers with extreme accuracy (sometimes within 3-5 feet). This was possible because of the ability for GPS to provide accurate velocity estimates and accurate data even at low altitudes. A short video tape of this demonstration was made and is available for viewing.

### 2.3 Fixed-Lag Smoother

Optimal smoothers have traditionally used fixed interval smoothers operating in a reverse time manner, starting at the end of a filtered data process and working backwards to the beginning. This technique is used where real-time highly accurate solutions are not needed and are typically performed as a post mission process. The Fixed-Lag Smoother works in parallel with the real-time optimal filter and uses filter information to produce state estimates that lag the real-time estimates by a small fixed interval.

# FPS 16 RADAR SITE

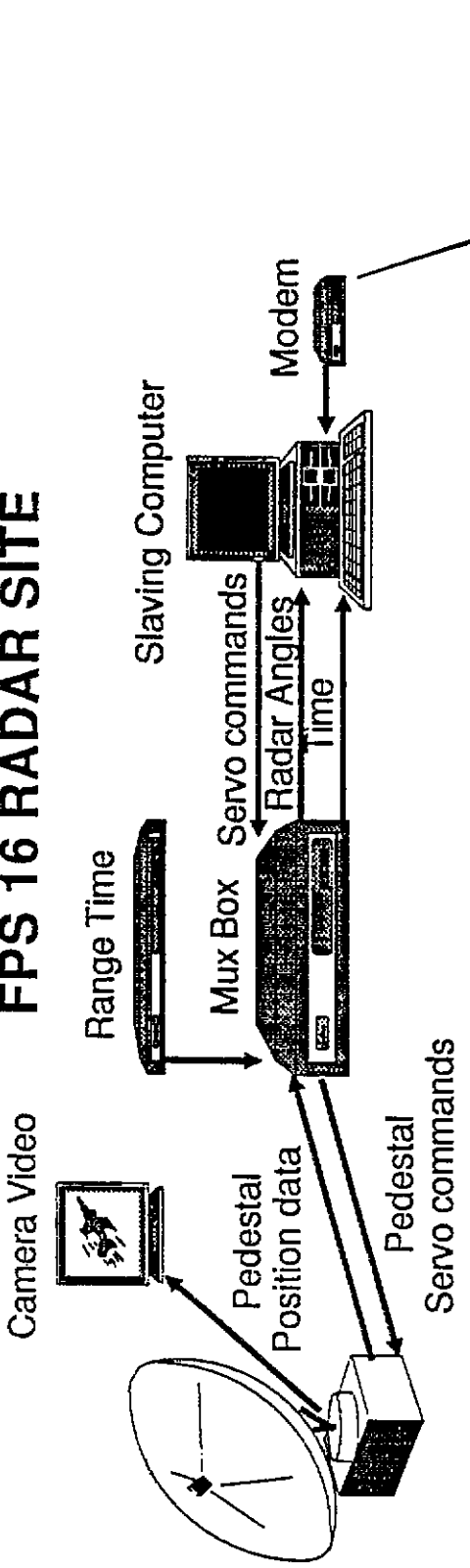

# CENTRAL CONTROL FACILITY

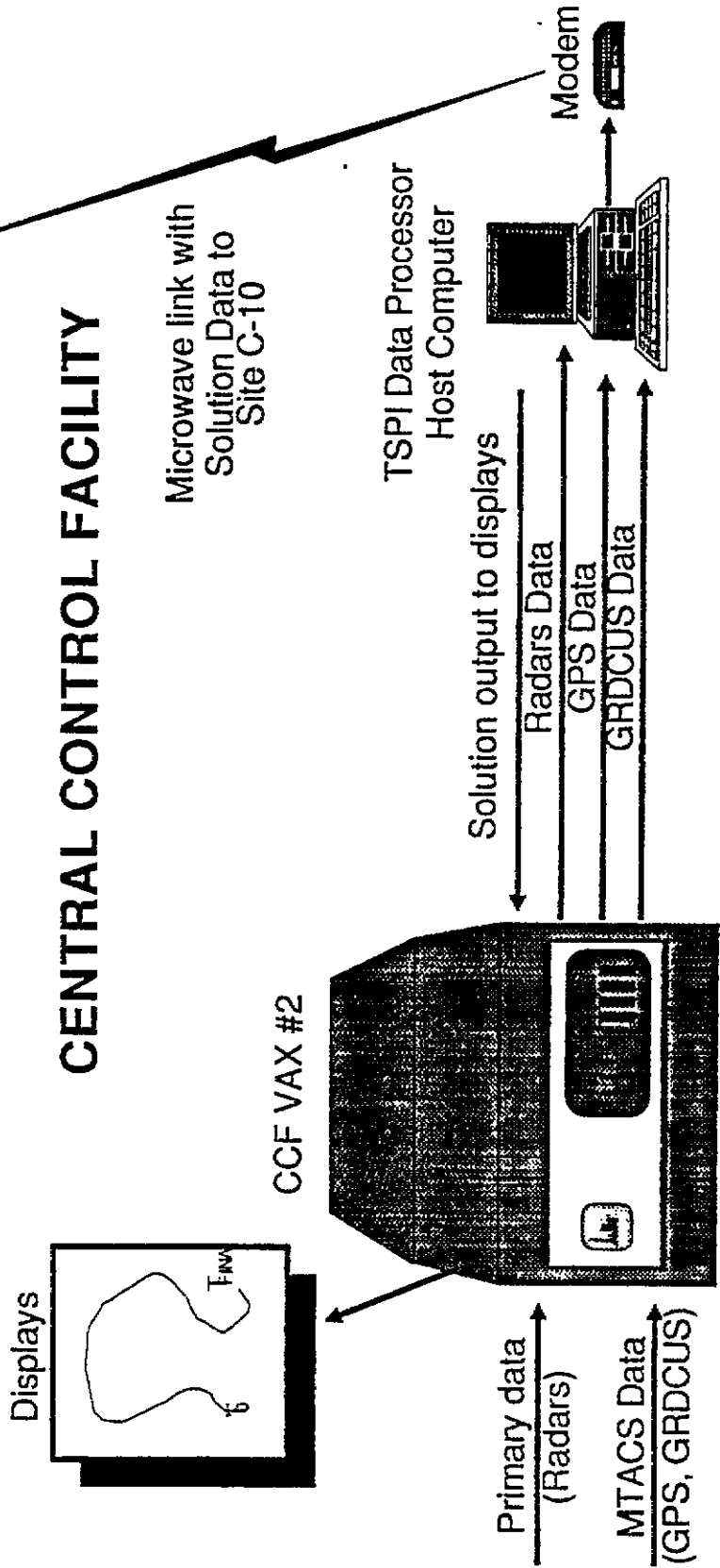

Figure 2-4. Breadboard interface connections

### **2.3.1 Fixed-Lag Smoother Software**

The algorithm essentially buffers data from the Filter over a small delta time period and then runs the smoother formulation backwards to the previous delta time interval. This process is continuous and smoothed, but slightly delayed estimates are provided along with the real-time output. All algorithms were coded in Ada and tested on a 386 PC but were not integrated into multiple transputers. Loading analysis indicated that the Fixed-Lag Smoother could be implemented using one additional transputer.

### **2.3.2 Fixed-Lag Smoother Performance**

The accuracy evaluation required the use of synthetic radar data and synthetic GPS pseudo-range and delta pseudo-range data. This provided a "truth" data set to compare the filtered results to. The synthetic data was corrupted with characteristic error signals for each range sensor. The first test used radar data at 5 Hz with a fixed lag of 2 seconds. The results compared the filter errors to the smoother errors. The smoother reduced the Root Mean Square (RMS) position error by 30 percent and the velocity errors by 70 percent. The next test used GPS data at 5 Hz with a 2 second lag. The position errors were reduced by 30 percent, the velocity errors more than 80 percent and acceleration errors by over 90 percent. (Ref 4.)

The Fixed-Lag Smoother demonstrated significant accuracy improvements relative to the real time filter with fixed lags of 0.5 to 2.0 seconds that are reasonable for most real-time needs. This provides a solution comparable in accuracy to post flight smoothing processes that typically required hours or even days of turnaround time. This work will continue during the Brassboard development.

## **2.4 Brassboard TDP**

The demonstrations in the previous efforts showed that low cost real-time TSPI data processors can be developed to provide optimal estimates to be used for slaving and mission analysis. This substantiated the need to develop a fieldable system to be used by all DoD Test ranges. The TDP system will improve the reliability and maintainability of DoD test range tracking systems through the use of standardized and common hardware. The use of common equipment required a survey of requirements from all applicable DoD test ranges. The results of these surveys are reflected in the system designs.

### **2.4.1 Brassboard System Designs**

The TDP will use industry standard computer processors, communications interfaces and software to provide accurate trajectory estimates through the integration of range sensor data. The minimum TDP will provide filtering for a single track and shall be expandable to allow filtering for up to six separate tracks simultaneously. When required, the full TDP will support up to three tracks and three smoothers simultaneously. The TDP will select, from an incoming data stream, the appropriate information and route it to proper processors providing the multiple TSPI tracks. Each track processor has the capability of processing data from up to 10 instruments and providing estimates at rates of up to 60 Hz. The configuration, control and monitoring of the TDP is



accomplished using an external Host Computer communicating via a well defined control/status interface.

The TDP will support three modes of operation. The first mode will provide a low latency (less than 0.1 seconds), high accuracy trajectory estimate to be used in slaving of closed loop systems such as video tracking systems. The second mode will provide near-real-time generation of higher accuracy estimates. These estimates can lag the current time by as much as 0.5 seconds and will be used for on-line analysis and display for mission control. The third mode will support smoothing to provide additional accuracy to the trajectory estimate. The smoothed trajectories will lag the filtered outputs by several seconds and can be used for post-flight mission review.

The TDP will use the VMEbus open system architecture well accepted by industry and the military. The use of this architecture provides the capability for end users to purchase low cost, non-proprietary, standard off-the-shelf modules to assemble and construct a TDP system. The TDP system architecture is shown in figure 2-5. The TDP is partitioned into two major sections known as the Range Interface and the Track Generator. The communications between these two sections will utilize the high performance VME data bus. The primary communications will be data flow, but the bus will also serve as a means for the Range Interface to control the processors in the track generator.

The Range Interface is responsible for input/output and control functions of the TDP. These functions include: receiving the raw data, receiving and processing control commands, monitoring the track generator output, routing data to the appropriate compute modules and all data conversions. The Range Interface will require at least one general purpose processor and one or more intelligent I/O cards. The Range Interface will also assume the role of the bus master for the VME system and places the VME chassis and bus within its domain. The addition of non-TDP hardware will be supported by the Range Interface with restrictions identified for address and interrupts. Some of the interfaces supported include: Host interface (status, command, and setup information), Track solution interface, Range Time interface and the sensor interface. The sensor interface is where the measurement data is made available for the TDP. The structure of this data has been organized to provide a generic description that can apply to many different facilities. These generic descriptions are provided in table 2-3.

The Track Generator modules perform the computationally intensive Kalman filtering of sensor data. The Track Generator accepts data and commands from the Range Interface and provides a filtered or smoothed output. Each module contains two high-performance microprocessors and is capable of executing either one filter or one smoother. It should be noted when configured as a smoother an additional module must be configured as a filter to provide the smoother the appropriate data.

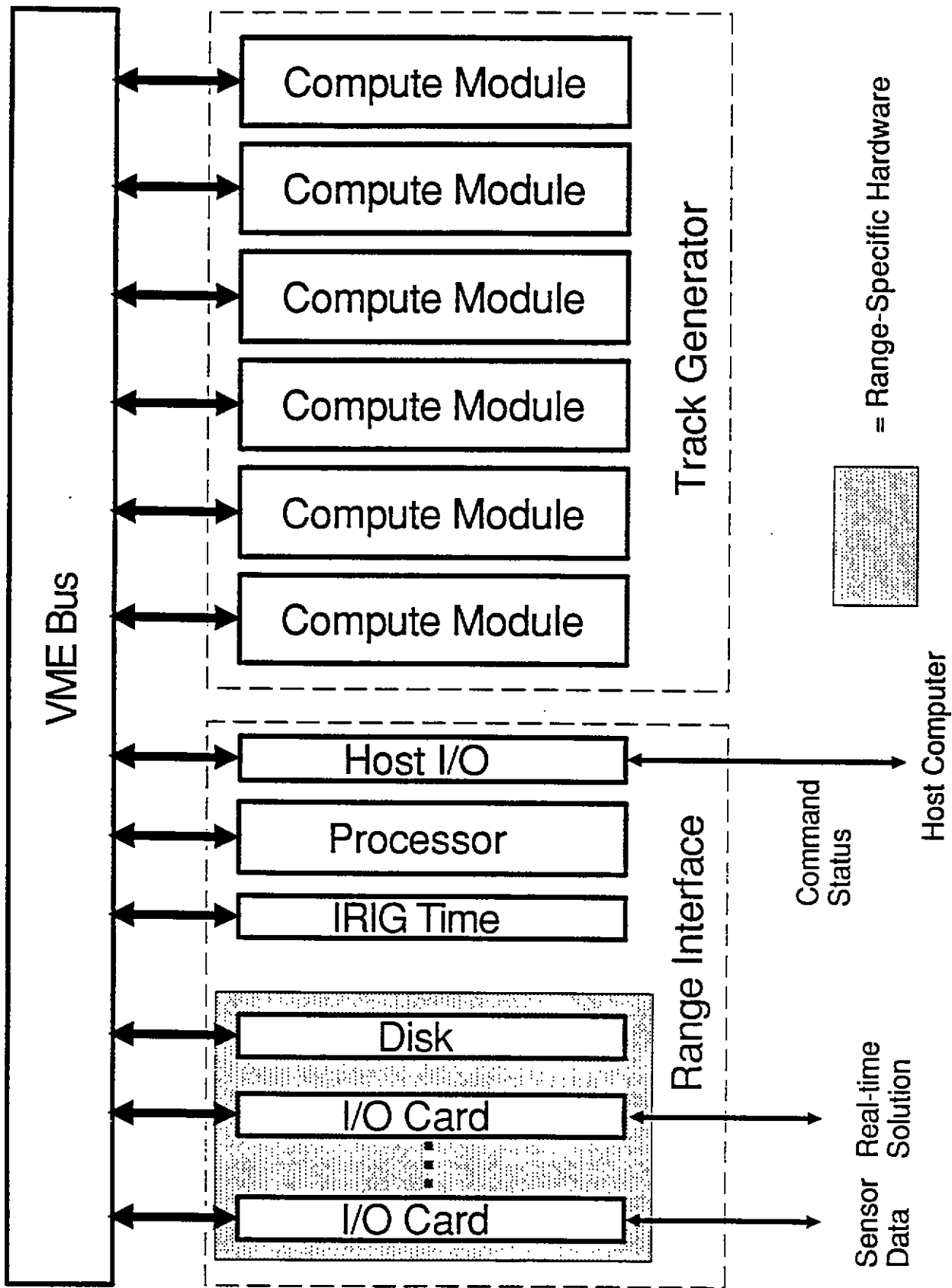

Figure 2-5. Brassboard TDP System Architecture

TDP DATA TYPE	CANDIDATE SENSORS	DATA DESCRIPTIONS
Ground based tracker	Conventional Radar, Laser Radar, Doppler Velocimeter Radar, MOTR Theodolite, Ranger	Azimuth, Elevation, Range, Range Rate. Used as filter measurements.
Altimeter	Baro Altimeter	Altitude above Spheroid. Used as filter measurements.
Cartesian Position	GPS XYZ Position Solution Other XYZ Position Solutions	XYZ ECEF Position or ENU Position (Fixed-Site Local Tangent Plane). Used as filter measurements.
Velocity	INS GPS XYZ Velocity Solution Other XYZ Velocity Solutions	XYZ ECEF Velocity or ENU Velocity (Fixed-Site Local Tangent Plane) or Velocity (Vehicle Local Level). Used as filter measurements.
Acceleration	INS Other Acceleration Source	Acceleration (Vehicle Local Level), Used to improve the INS Velocity model. (Optional)
Attitude	INS Other Attitude Source	Heading, Pitch, Roll. Used to improve track-point corrections (Optional)
GPS Raw Measurements	HDIS, Joint Program Office User Equipment. Other GPS receivers	Pseudo-range, Delta Pseudo-range. Used as filter measurements.
GPS Satellite Constellation	GPS Receiver GPS Reference Receiver	Various Ephemeris quantities for determining satellite locations. Used to support processing of raw GPS.
GPS Reference Receiver	Range Applications JPO GPS Reference Receiver. Other GPS Reference Receivers.	Differential corrections, Tropospheric correction, Ionospheric delay, rate of change for iono delay. Used for differential corrections of raw GPS.
Model Aiding Event	Bomb Tone, Telemetry, Other Event Signal	Event Signal. Used to transition filter from dead reckoner to model aided.
Model Aiding Reference	Off-Line Simulation	Position, Velocity and acceleration time history. Stored at setup.

Table 2-3. Generic data descriptions (Ref 5.)

The algorithms from the previous tasks will be adapted to increase and add new requirements from various DoD Test ranges. The original strategy for the brassboard designs would have used the next generation transputer, but INMOS will not have it available in time for our development. The present approach will utilize the latest Reduced Instruction Set Computing (RISC) microprocessors that have been benchmarked at 10 to 12 times faster than the T800 Transputer used in the breadboard. The importance of these high performance processors becomes evident when the TDP is providing very low latency real-time estimates for systems like those discussed in section 3.

### **3. TDP APPLICATIONS**

The use of real-time optimal TSPI estimates can provide many benefits for flight tests at DoD ranges. Some applications that are well suited for the TDP are addressed in the following sections.

#### **3.1 Conventional Slaving Systems**

Current Radar Simulation systems require high accuracy, low latency TSPI solutions to accurately point radar emitters for systems evaluation. As demonstrated during the breadboard flight testing the TDP is quite capable of providing solid, accurate and low latency solutions to be used for pointing these and other types of systems.

Other applications require the illumination of a target for higher accuracy tracking systems to acquire. An example of this could be an infrared optical tracking system using the TDP to point an infrared emitter allowing the tracker to acquire the target or eliminating background interference by detecting the illuminated target.

An obvious application of the TDP's real-time solution is to provide a best estimate of trajectory to be used in pointing video theodolites. The improved accuracy of a TDP solution relative to a raw or single sensor system will allow tracking with longer focal lengths, and hence greater effective resolution, of targets. The TDP breadboard system was used quite successfully in this mode during 1991 demonstrations at Eglin AFB.

#### **3.2 Real-time Integration of Video Tracker Data**

The TDP has been developed to allow the processing of both raw and filtered data. This allows the solution provided by a centralized TDP to be used as an input to a TDP processing video tracker data. The pedestal and offset data would be sent through the local TDP operating in a fixed-lag smoother mode to provide high accuracy, near-real-time trajectory solutions. These solutions could be used locally or sent back to the centralized location for real-time mission analysis.

#### **3.3 Closed Loop Integration of Video Tracker Data**

A very useful TDP application is the incorporation of the TDP in a closed loop mode with optical trackers. This is shown in Figure 3-1. Here the high accuracy solution that incorporates all of the video tracker data into the solution is fed back to each mount. The major advantage of this approach is to provide automatic correction when a single mount loses track (e.g., the video tracker locks onto the wrong object). The filter will reject the data from the mount that has lost track because it will be inconsistent with the other sensors. However, all mounts will continue to receive correct pointing commands (including the incorrect mount) based on the incorporation of the data from all the on-track video systems. This provides improved robustness and should significantly enhance the effectiveness of the individual pedestal/tracker.

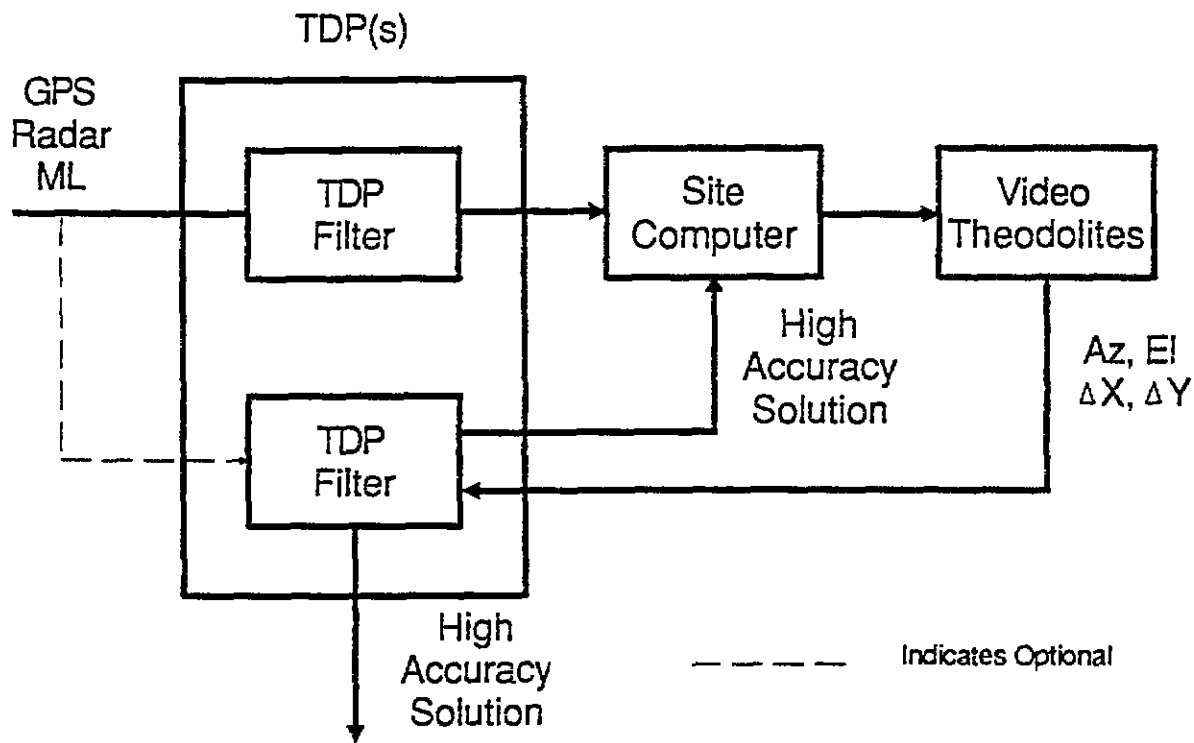

Figure 3-1. Closed Loop Tracker data integration

### 3.4 Model Aiding

Objects having extremely rapid changes in acceleration (jerk) have typically been extremely problematic for video and other types of tracking systems. The TDP can overcome these problems through its support of a "model aided" filtering mode. In this mode an external event (e.g., telemetry signal) is used to trigger the use of an a priori velocity profile in the filter. The filter uses this for state propagation and therefore only has to track the variation from the expected trajectory. This improves the ability to follow the target, and improves the filtering output since the filter gain, and Q can be kept low. (Ref 6.)

### 3.5 Improved Real-Time Data Accuracy/Reliability

With the rapid advancements in weapon systems development, test range requirements have become increasingly complex. DoD test ranges are finding that these systems require larger test areas for systems evaluation. The TDP can provide improved real-time accuracy/reliability thereby reducing the safety footprint requirement and allowing efficient testing of longer range munitions.

### 3.6 Current Planned Applications

The TDP project is actively involved in several video related applications. At Eglin the TDP will be demonstrated at two facilities. In the Central Control Facility, the TDP will be used provide mission managers with BET solutions in real-time. This solution will also be made available for

other range users. A second facility, a 3 station video tracker range, will use the TDP to support slaving, real-time video integration, and closed loop tracking. The TDP at that site will also include a processor to calculate and output error signals to the pedestal servos. This computer will use shared VME bus memory to minimize system latency. Figure 3-2 illustrates this system.

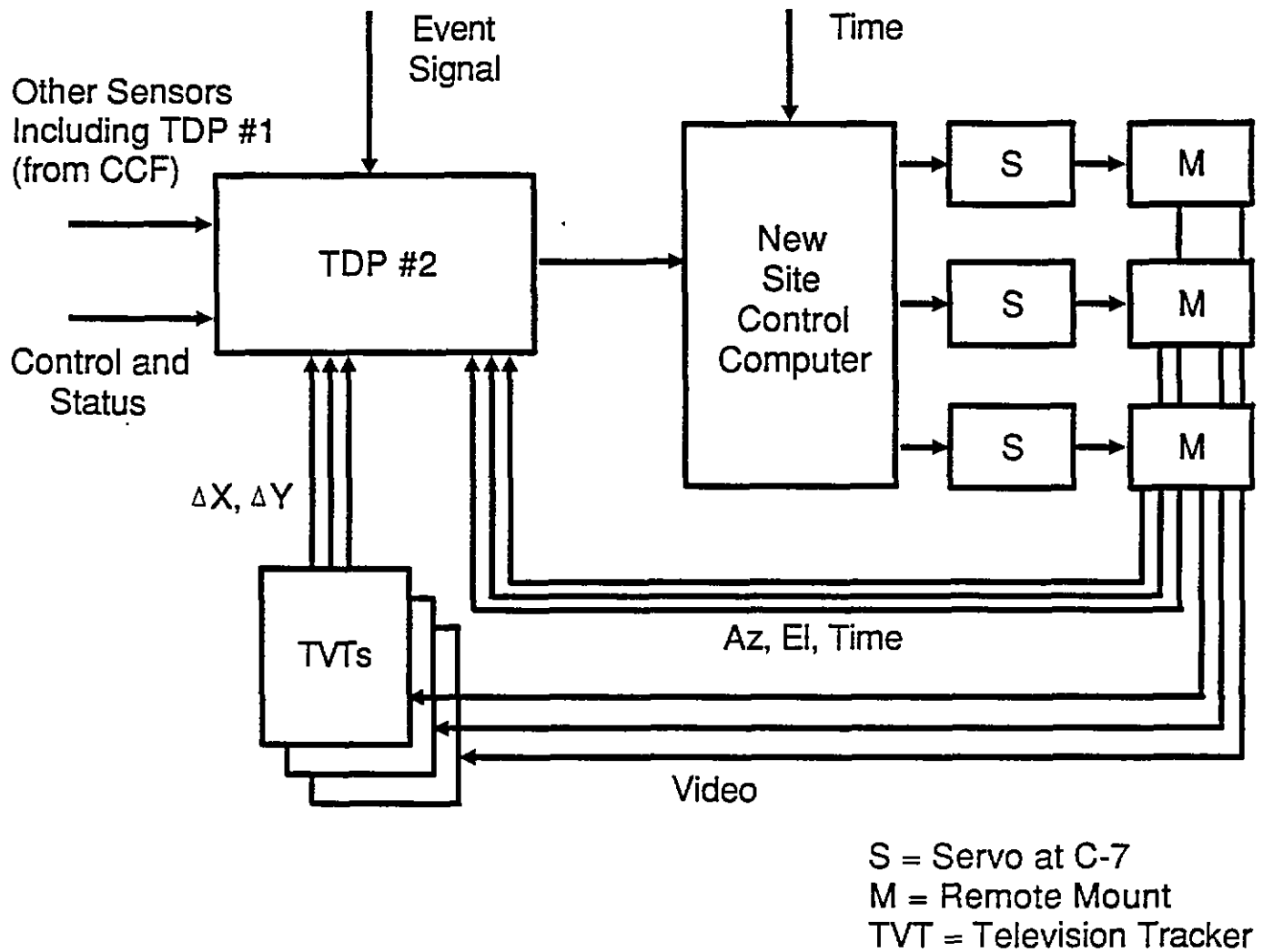

Figure 3-2. Remote Site TDP system

A similar project at White Sands is initially limited to processing a large number of radar tracks and providing pointing commands to documentation cameras. It is expected that this will be upgraded to closed-loop control of the video system.

Finally, there are tentative plans for the use of the TDP in a mobile theodolite (KTM mount) system. In this Edwards Air Force Base system, the TDP would provide both real-time coordination of the mounts and quick-look TSPI results.

#### 4. CONCLUSION

The TSPI Data Processor breadboard, developed by Wright Laboratory, demonstrated that low cost processors can be used to process and integrate range test data from multiple range sources and compute optimal real-time TSPI solutions for test aircraft and weapons. The current effort will develop standardized, fault tolerant, and ruggedized TDP systems for use at DoD test ranges.

Real-Time integration of TSPI data can provide many benefits. Use of the TSPI Data Processor can significantly increase the Services' capability to evaluate new aircraft and weapon systems. The current procedure for flight test missions is to process TSPI data after the mission is completed. If the test engineer determines that the data was not adequate, then all test resources are rescheduled and another mission is flown. The TSPI Data Processor can provide accurate data that would allow the test engineer to assess the mission while it is in progress. This capability, when coupled with real-time test item data, could reduce the number of flight test missions by a factor of 2 or more, with like reductions in test costs. For the first time, it allows presently installed range instrumentation to be integrated with, and optimally benefit from, the much improved performance that real-time GPS data can provide.

#### 5. REFERENCES

1. Gross, L., Investigation of Precision Tracking Platform for Portable TSPI.  
Report No. R-012-88, Ball Systems Engineering Division, San Diego, CA, February 1988.
2. Gross, L., TSPI Processor Demonstration Subtasks 1 & 2 Final Report.  
Report No. R-040-89, Ball Systems Engineering Division, San Diego, CA, May 1989.
3. Gross, L., TSPI Processor Final Report.  
Report No. R-020-91, Ball Systems Engineering Division, San Diego, CA, July 1991.
4. VanderStoop, D., Development and Evaluation of Fixed-Lag Smoother.  
Report No. R-008-91, Ball Systems Engineering Division, San Diego, CA, March 1991.
5. Gross, L., Rozelle, K., TDP System Design Review.  
Report No. B-034-92, Ball Systems Engineering Division, San Diego, CA, June 1992.
6. Rozelle, K., Todd, J., Square Root Information Filter Adaptation.  
Report No. R-082-87, Ball Systems Engineering Division, San Diego, CA, September 1987.

# **TSPI DATA PROCESSOR**

**AIR FORCE WRIGHT LABORATORY**

**ARMAMENT DIRECTORATE**

**INSTRUMENTATION TECHNOLOGY BRANCH**

**EGLIN AFB, FLORIDA**

**MNSI POC  
Ken Williamson  
DSN 872-8434**



# TSPI DATA PROCESSING (PRESENT)

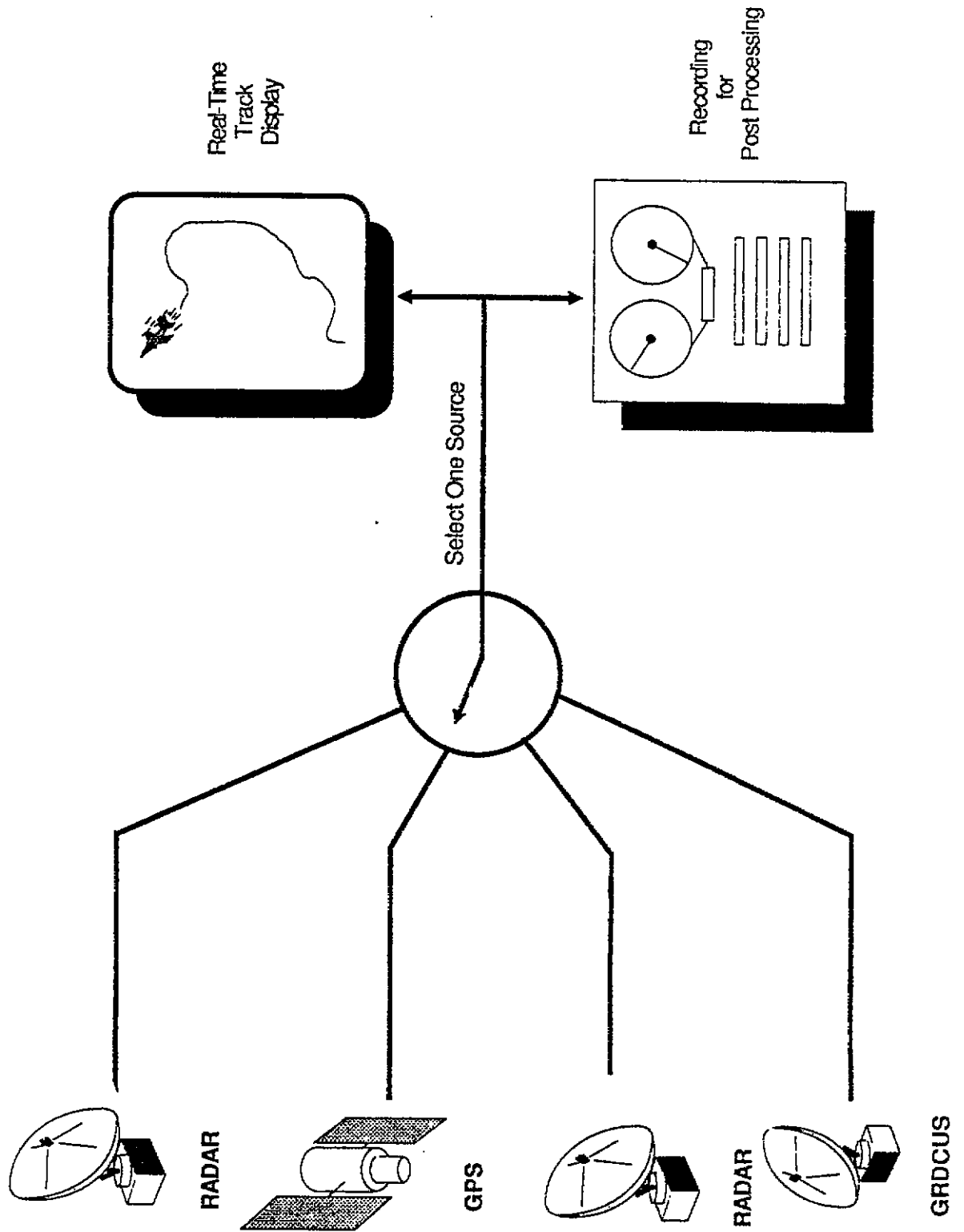

# TSPI DATA PROCESSING (OPTIMAL)

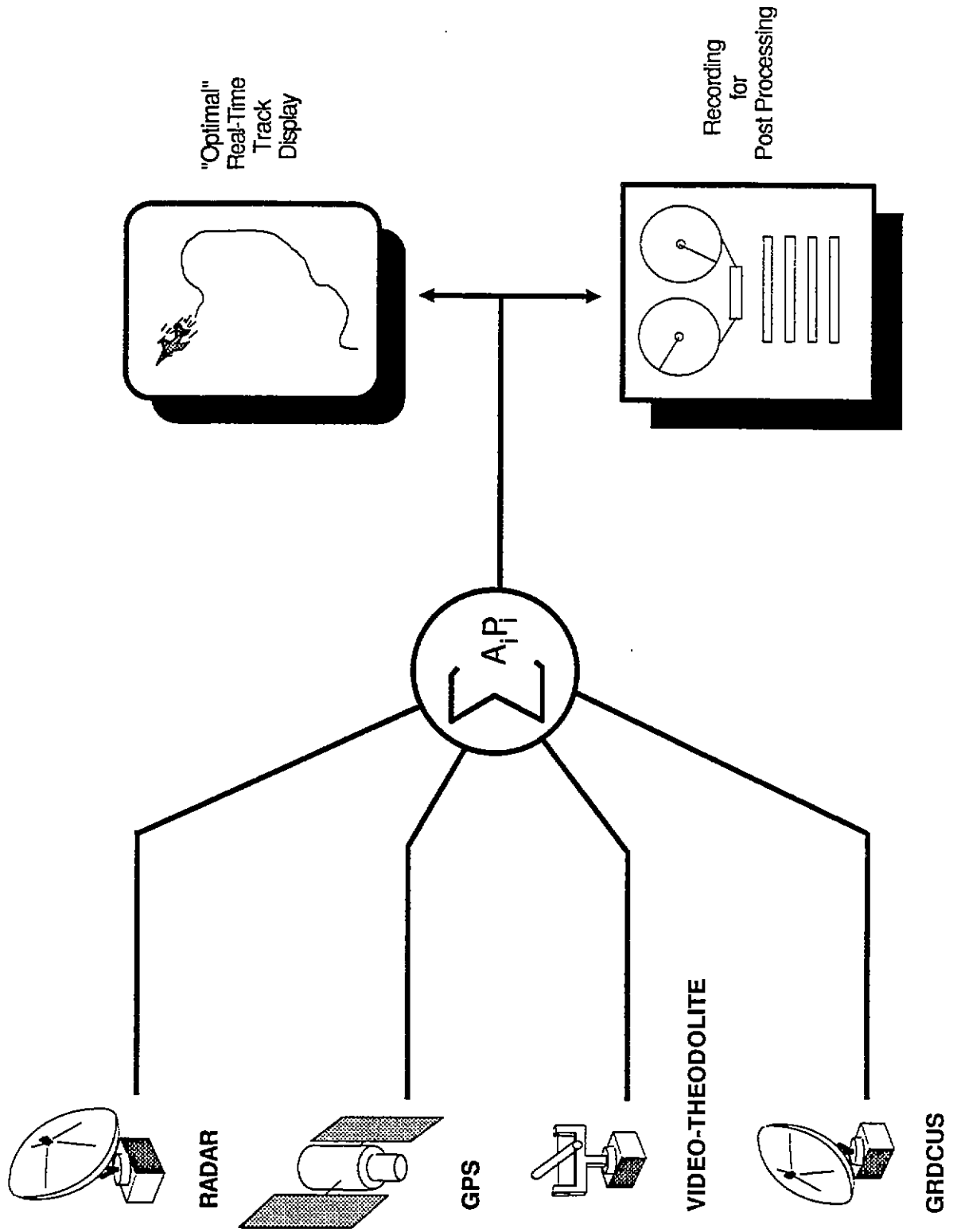

# TSPI DATA PROCESSOR

- PROGRAM
  - DEVELOP LOW COST, TSPI DATA PROCESSOR (TDP) TO INTEGRATE MULTIPLE SENSOR DATA AND PROVIDE (IN REAL-TIME) OPTIMAL TSPI ESTIMATE. DEMONSTRATE ITS UTILITY UNDER ACTUAL FLIGHT TEST CONDITIONS.
- MULTI-PHASE PROGRAM
  - PHASE I - MULTI-RADAR TSPI DATA PROCESSOR
  - PHASE II - MULTI-SENSOR TSPI DATA PROCESSOR
  - PHASE III - BRASSBOARD MULTI-TRACK TSPI DATA PROCESSOR

# **TDP BRASSBOARD GOALS**

**DEVELOP SYSTEM TO PROCESS AND INTEGRATE  
VARIOUS SENSOR DATA AND PROVIDE HIGH ACCURACY  
REAL-TIME ESTIMATES**

**PROVIDE PROCESSING AT LOW COST ( LESS THAN \$10K  
PER TRACK)**

**DESIGN SYSTEM FOR EASY INTEGRATION FOR  
VARIOUS DOD APPLICATIONS (SLAVING, PORTABLE  
SYSTEMS, AND CENTRAL FACILITIES)**

**UTILIZE EVOLVING OPEN ARCHITECTURE CONCEPTS**

**DEVELOP ALL CODE IN ADA**

TDP DATA TYPE	CANDIDATE SENSORS	DATA DESCRIPTIONS
Ground based tracker	Conventional Radar, Laser Radar, Doppler Velocimeter Radar, MOTR Theodolite, Ranger	Azimuth, Elevation, Range, Range Rate. Used as filter measurements.
Altimeter	Baro Altimeter	Altitude above Spheroid. Used as filter measurements.
Cartesian Position	GPS XYZ Position Solution Other XYZ Position Solutions	XYZ ECEF Position or ENU Position (Fixed-Site Local Tangent Plane). Used as filter measurements.
Velocity	INS GPS XYZ Velocity Solution Other XYZ Velocity Solutions	XYZ ECEF Velocity or ENU Velocity (Fixed-Site Local Tangent Plane) or Velocity (Vehicle Local Level). Used as filter measurements.
Acceleration	INS Other Acceleration Source	Acceleration (Vehicle Local Level), Used to improve the INS Velocity model. (Optional)
Attitude	INS Other Attitude Source	Heading, Pitch, Roll. Used to improve track-point corrections (Optional)
GPS Raw Measurements	HDIS, Joint Program Office User Equipment. Other GPS receivers	Pseudo-range, Delta Pseudo-range. Used as filter measurements.
GPS Satellite Constellation	GPS Receiver GPS Reference Receiver	Various Ephemeris quantities for determining satellite locations. Used to support processing of raw GPS.
GPS Reference Receiver	Range Applications JPO GPS Reference Receiver. Other GPS Reference Receivers.	Differential corrections, Tropospheric correction, Ionospheric delay, rate of change for iono delay. Used for differential corrections of raw GPS.
Model Aiding Event	Bomb Tone, Telemetry, Other Event Signal	Event Signal. Used to transition filter from dead reckoner to model aided.
Model Aiding Reference	Off-Line Simulation	Position, Velocity and acceleration time history. Stored at setup.

# TSPI DATA PROCESSOR

## IMMEDIATE-FILTER MODE

- Low Latency (less than 0.1 Sec from time data arrived at TDP)
- Real-time pointing/slaving applications
- Filter immediately uses all available data when completed with previous filter cycle

## DELAYED-FILTER MODE

- Moderate latency (up to 0.5 Sec)
- Real-time mission display/analysis applications
- Filter waits for arrival of key data before next filter cycle

## LAGGED-SMOOTHER MODE

- Larger latency (dependent on smoother lag)
- Near-Real-Time display/analysis applications
- Fixed-Lag Smooth based on filter results

# **FIXED LAG SMOOTHER**

- ADDITIONAL ACCURACY AT THE PRICE OF ADDITIONAL LATENCY.
- CURRENT OFF-LINE SYSTEMS (EGLIN TDOP, ARDS SYSTEM) PERFORM TWO-PASS PROCESSING
  - FORWARD FILTERING
  - BACKWARD SMOOTHING
- TDP UTILIZES FIXED INTERVAL WITH SHORT INTERVALS RECURSIVE TECHNIQUES WERE NUMERICALLY UNSTABLE.

# FIXED INTERVAL SMOOTHING

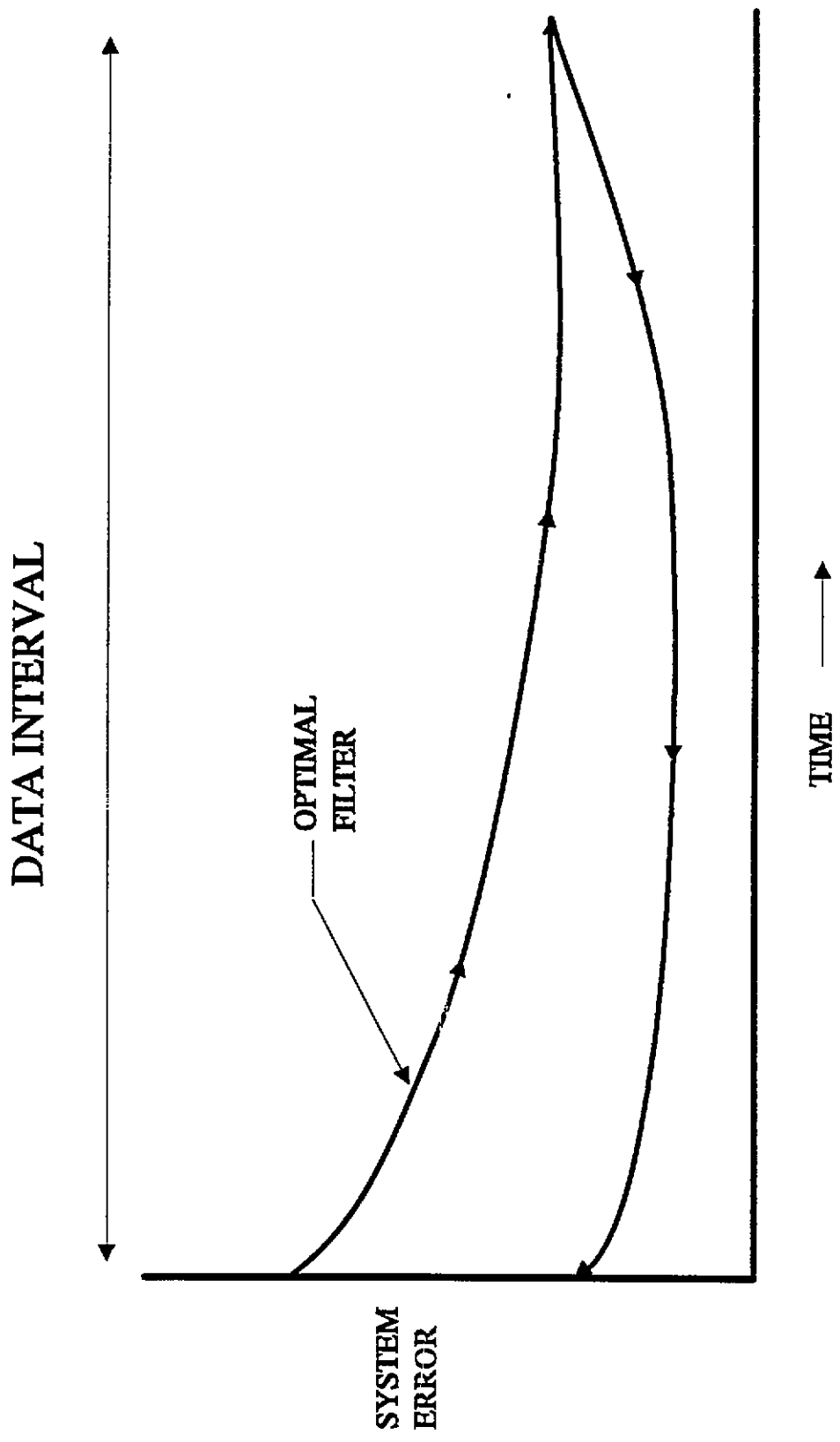



# FIXED LAG SMOOTHER

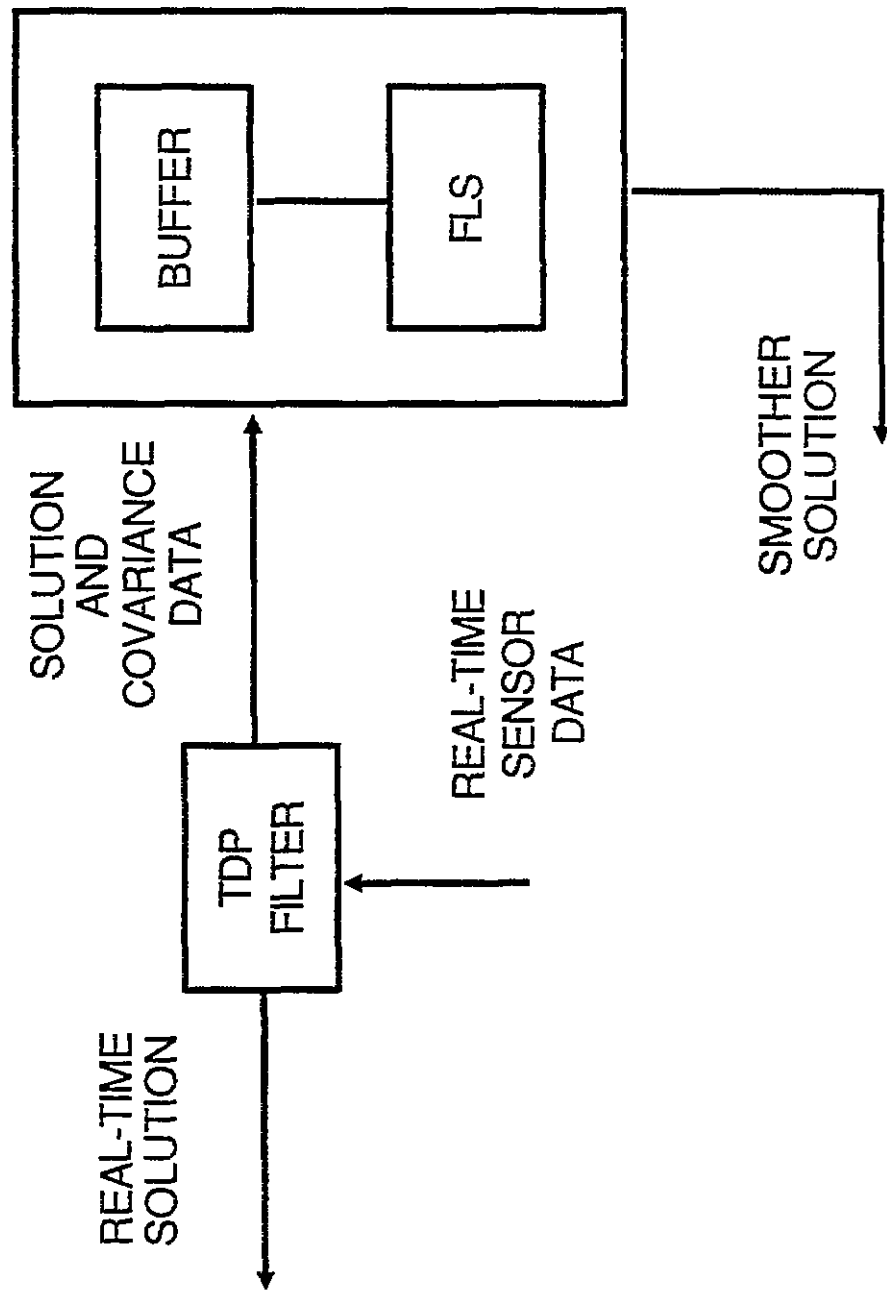

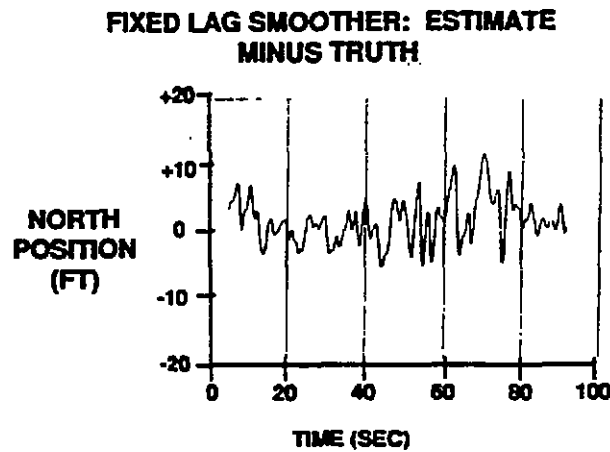
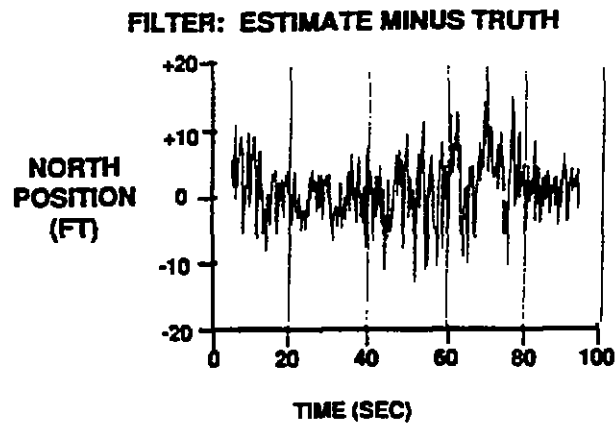

<b>COMPARISON SUMMARY - ONE-SIGMA POSITION ERROR, FT -</b>			
	<b>FILTER</b>	<b>SMOOTHER</b>	<b>PERCENT IMPROVEMENT</b>
<b>NORTH</b>	4.8	3.4	29
<b>EAST</b>	3.6	2.4	33
<b>UP</b>	4.0	2.6	39

Figure 3-2. Comparison of Real-Time Filter and Fixed-Lag Smoother (Position Accuracy).

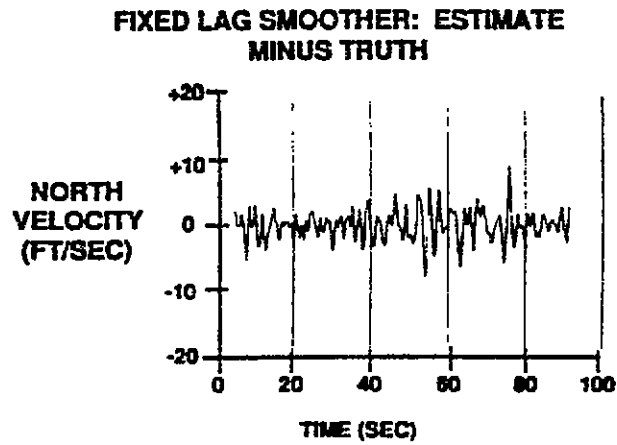
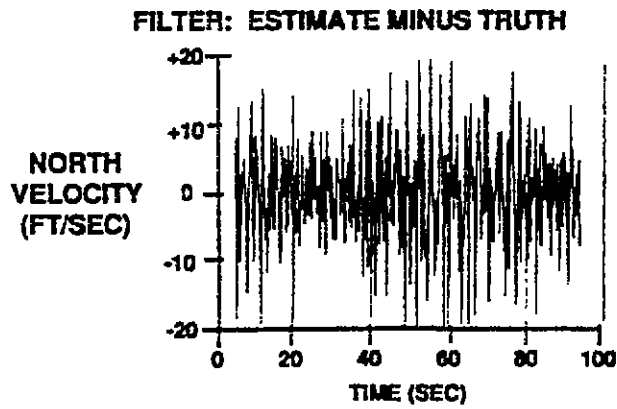

<b>COMPARISON SUMMARY</b>			
<b>- ONE-SIGMA VELOCITY ERROR, FT/SEC -</b>			
	<b>FILTER</b>	<b>SMOOTHER</b>	<b>PERCENT IMPROVEMENT</b>
<b>NORTH</b>	<b>15.3</b>	<b>4.8</b>	<b>69</b>
<b>EAST</b>	<b>12.5</b>	<b>3.8</b>	<b>70</b>
<b>UP</b>	<b>14.8</b>	<b>4.5</b>	<b>70</b>

Figure 3-3. Comparison of Real-Time Filter and Fixed-Lag Smoother (Velocity Accuracy).

- Pseudorange and delta pseudorange measurements at 5 Hz.
- Fixed Lag = 2 sec (10 measurements).

**POSITION ERROR**

	<b>FILTER</b>	<b>SMOOTHER</b>	<b>% IMPROVEMENT</b>
<b>EAST</b>	<b>0.4</b>	<b>0.3</b>	<b>25</b>
<b>NORTH</b>	<b>1.0</b>	<b>0.6</b>	<b>40</b>
<b>UP</b>	<b>1.4</b>	<b>1.2</b>	<b>14</b>

**VELOCITY ERROR**

	<b>FILTER</b>	<b>SMOOTHER</b>	<b>% IMPROVEMENT</b>
<b>EAST</b>	<b>1.2</b>	<b>0.09</b>	<b>93</b>
<b>NORTH</b>	<b>0.9</b>	<b>0.15</b>	<b>83</b>
<b>UP</b>	<b>0.9</b>	<b>0.13</b>	<b>86</b>

**ACCELERATION ERROR**

	<b>FILTER</b>	<b>SMOOTHER</b>	<b>% IMPROVEMENT</b>
<b>EAST</b>	<b>24</b>	<b>0.63</b>	<b>97</b>
<b>NORTH</b>	<b>16</b>	<b>1.5</b>	<b>91</b>
<b>UP</b>	<b>17</b>	<b>0.69</b>	<b>96</b>

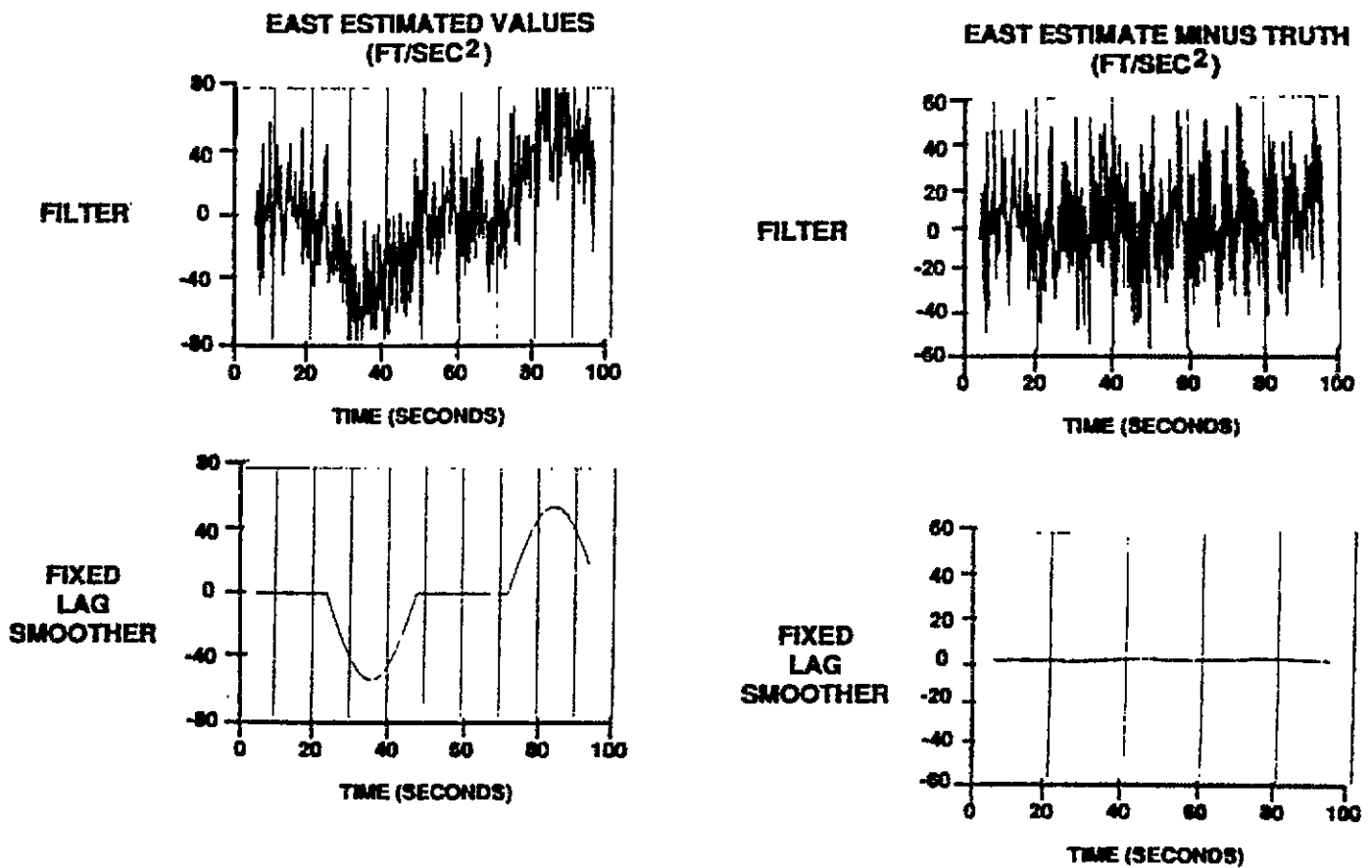

Figure 3-4. Acceleration Estimation with Fixed-Lag Smoother is Particularly Impressive

# **FIXED LAG SMOOTHER**

- **LAGGING SMOOTHED ESTIMATES PROVIDED SIMULTANEOUSLY WITH REAL-TIME ESTIMATES.**
- **A MEANS TO PROVIDE A SET OF DATA TO THE CUSTOMER IMMEDIATELY FOLLOWING THE MISSION FOR QUICK LOOK ANALYSIS**
- **CAN BE DISPLAYED FOR NEAR-REAL TIME ANALYSIS**

# TDP APPLICATIONS

- RADAR SIMULATION/EMITTERS
- OPTICAL ILLUMINATORS
- POINTING OF HIGH ACCURACY TRACKING SYSTEMS FOR ACQUISITION
- PROVIDING REAL-TIME ESTIMATES OF INTEGRATED OPTICAL TRACKER DATA
- CLOSED LOOP INTEGRATION OF OPTICAL TRACKERS
- MODEL AIDING FOR RAPID CHANGES IN TARGET DYNAMICS

# TSPI DATA PROCESSOR MODEL AIDING

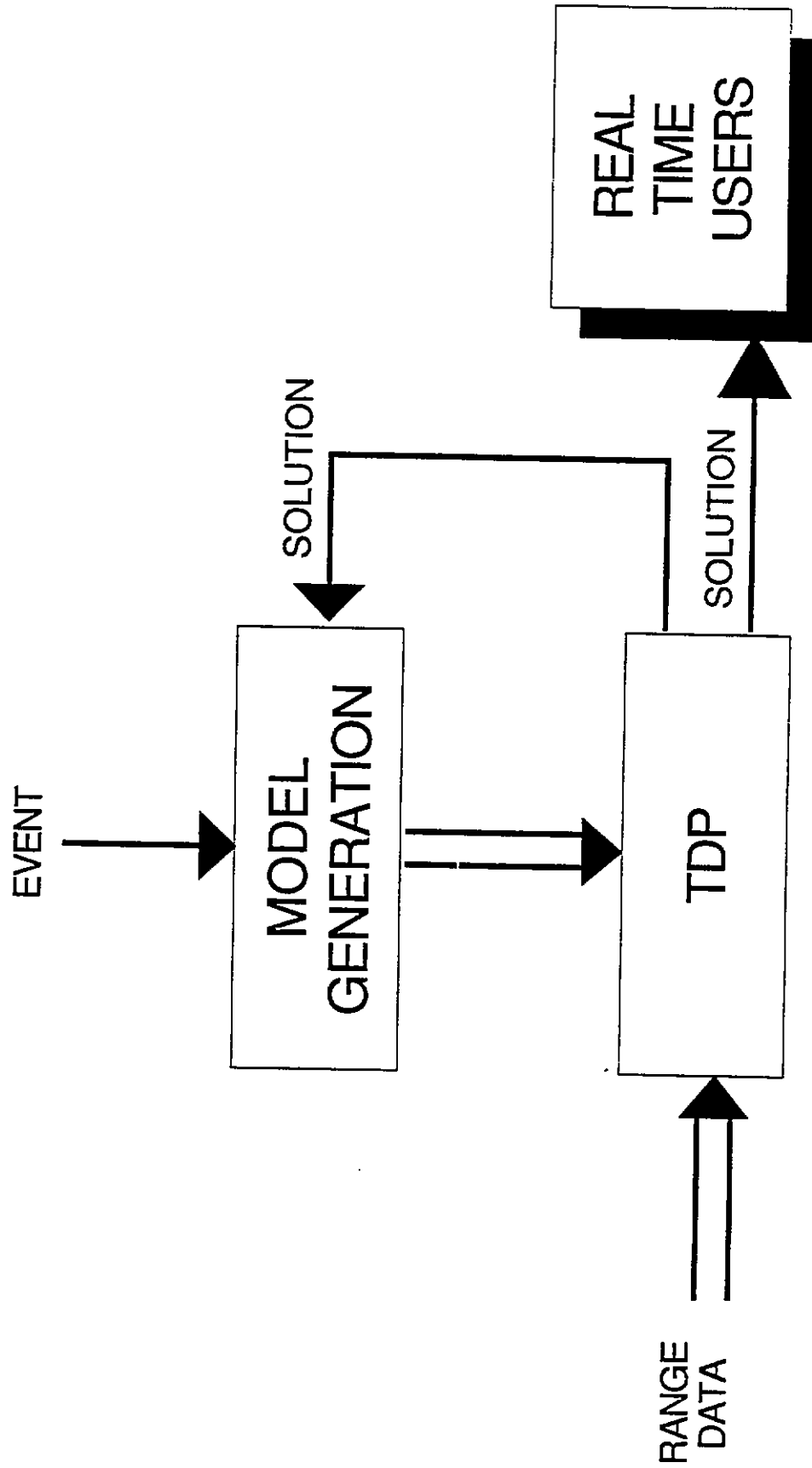



# **TSPI DATA PROCESSOR MODEL AIDING**

- IMPROVES KALMAN FILTER RESULTS WHEN OBJECT DYNAMICS CAN BE PREDICTED.
- THE MODEL PROVIDES THE MEANS TO OVERCOME ERRORS CAUSED BY FILTER CONSTANT ACCELERATION ASSUMPTIONS DURING THE TIME UPDATE INTERVAL.
- TDP WILL BE ABLE TO ACCEPT EXTERNAL MODELS IN TABLE FORM.

# TSPI DATA PROCESSOR

## MUNITION SCENARIO

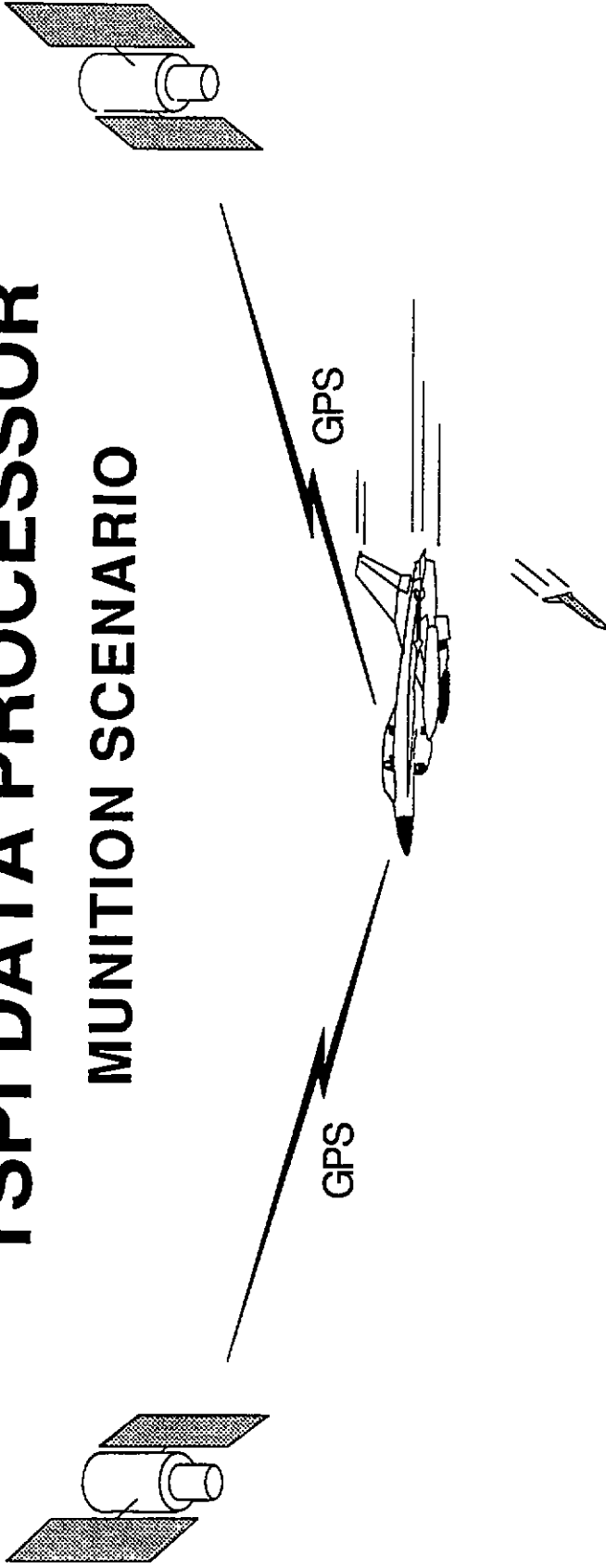

TO/ FROM  
TDP

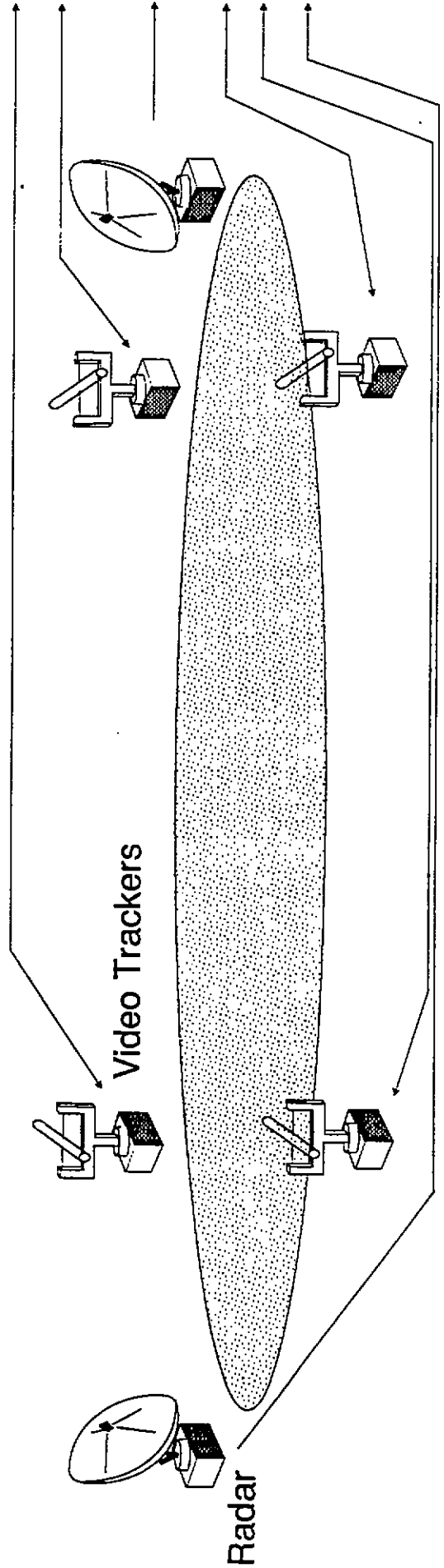

# Time Space Position Information Data Processor

## MILESTONE SCHEDULE

### PHASE II

GPS/RADAR SLAVING DEMO



### PHASE III

RANGE REQUIREMENTS



BRASSBOARD DESIGNS



SYSTEMS LEVEL REVIEW



DETAIL DESIGN REVIEW



DESIGN IMPLEMENTATION



INTEGRATION/FLIGHT TESTS

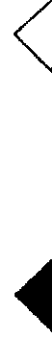

IOC



HW/SW REQUIREMENTS  
SUPPORT



1	2	3	4	O	N	D	J	F	M	A	M	J	J	A	S	1	2	3	4
FY92				FY93												FY94			



THE DEVELOPMENT AND PRODUCTION  
OF NEAR-REAL-TIME REPORTS  
AT  
WHITE SANDS MISSILE RANGE

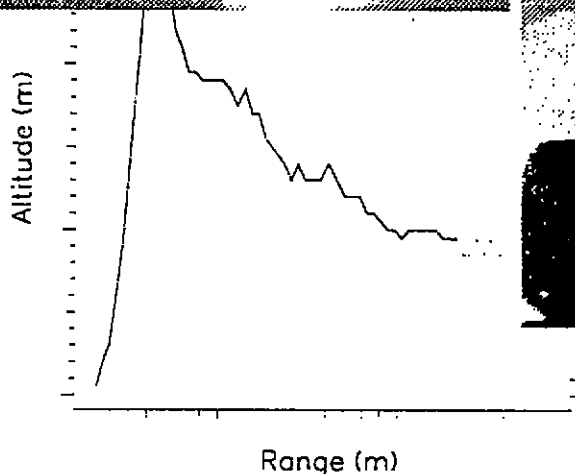

MAY, 1992

*Prepared by*  
**Michael S. Garcia**  
Computer Engineer

Software Branch  
Data Sciences Division  
National Range Operations Directorate  
White Sands Missile Range, New Mexico

## TABLE OF CONTENTS

	<u>Page</u>
Introduction	1
The Rise of "Quick Look"	1
The Decline and Rebirth of "Quick Look"	2
Basic Requirements for New NRTRs	3
NRTR Data Sources	3
NRTR Template Generation	4
IGDS TSPI Data Collection	4
Video/Optical Data Collection	5
NRTR Final Production	5
NRTR Production Time	6
Maximizing NRTR Value	6
<b>Figure 1 - Main NRTR Platform in IGDS Host Network</b>	<b>7</b>
The Final product	8
NRTR Production System Components	9
Conclusion	9
Epilogue - After a Year of Production - written August 1993	9a
<b>Appendix A - First NRTR Template</b>	<b>10</b>
<b>Appendix B - Refined NRTR Template</b>	<b>15</b>
<b>Appendix C - First Actual NRTR</b>	<b>19</b>



## INTRODUCTION

It has been quite interesting to observe the cyclic waxing and waning of Test and Evaluation reporting requirements over the last several years. The changing geopolitical, fiscal, technological and chronological facets of the Test and Evaluation (T & E) arena have driven these requirements through a nearly circular course of development, decline, and redevelopment, as each has evolved to exert varying influence upon the overall reporting process. As data scientists we have struggled to track and define these changing requirements and implement state-of-the-art hardware and software systems designed to meet current reporting needs and provide for those in the foreseeable future. Of particular interest here will be the details of these aforementioned elements as they pertain to publication of Near-Real-Time data reports (NRTRs), often referred to as quick-look reports; the evolution of requirements for these kinds of data representations at White Sands Missile Range, NM (WSMR); the concepts and methodologies employed by data scientists at WSMR to meet current requisites in this area; and the plans, being made at this very moment, to meet the projected near-real-time reporting needs of the Army well into the next century.

## THE RISE OF "QUICK-LOOK"

A decade and a half ago, renewed interest was building rapidly in the idea of generating "quick-look" representations of data being collected in real-time. Test data collection and reduction requirements had become immense with huge volumes of data being generated upon which extremely complex iterative processes were being performed to derive test results. As testing costs escalated more measurements were being squeezed out of fewer test flights, further adding to data collection and reduction burdens. The most obvious effect of these ever increasing test requirements was a commensurate increase in the post-flight data reduction time period needed to meet them. Test conductors could expect to wait up to 30 days to receive reduced data reports from a modestly complex mission. To provide interim data products during this post-flight period many test ranges put together special quick-look systems usually comprised of strip chart recorders, video hard-copy machines, video recorders, data collection computer line printers, pen-plotters and other data display system hardcopy devices. These systems supplied the test conductor with "raw" data, on paper and in real-time, that could usually give some good initial indications of the relative success or failure of key elements of a particular test. These initial results, that could be immediately reported up the chain of command, were becoming increasingly important to the political, administrative and budgetary captains with whom the futures

of many projects were resting. Although definitely "quick" these data representations were fraught with limitations. They were produced in as many different formats and form sizes as there were machines to produce them, with each data source producing a distinct and separate output that was generally incompatible with those of other sources. These materials were invariably in forms that required a good deal of analytical interpretation and were useful only to those individuals that had extensive and specific knowledge of the test. This reliance on manual interpretation also led, on occasion, to the release of subjectively positive or negative results that could not later be verified. As such, the information had no lack of accuracy or detail, but was monochromatic, repetitive, incohesive and generally unappealing to the eye - certainly not the kind of material that one would forward to the Pentagon for consideration.

### **THE DECLINE AND REBIRTH OF "QUICK-LOOK"**

Faced with these limitations and encouraged by post-flight data reduction latencies that were shortening as computing technologies caught up with, then surpassed, test requirements, test conductors seemed to lose their interest in quick-look data products during the 1980s. So much so that many of the software and hardware systems set up to provide them at WSMR were ultimately removed from service for lack of use. The decade of the nineties, however, has brought with it staggering budget deficits, shrinking defense spending, and a fiercely competitive market for Government contracts, T & E dollars and development funding. Test conductors, Program Managers and Range Commanders are compelled not only to provide progressive technical results but to continuously justify their very existence, and "sell" their products as being the very best and most cost effective that are available. With new technologies emerging daily and both private and public budget axes falling all around, decisions that dramatically effected the futures of many programs, were being made at the highest administrative levels, from one moment to the next, using whatever information was currently available. Here at WSMR it was realized that the stage was being set, again, for the reemergence of quick-look materials as vital T & E data products. The task was set then, to redefine this type of test reporting and find state-of-the-art solutions that would eliminate the limitations of past systems and break new ground in the application of desktop publishing applied to the production of near-real-time test reports.

## BASIC REQUIREMENTS FOR NEW NRTRs

Armed with observations of past quick-look systems and well aware of the new T & E environment of the 90s (ie. sell, sell, sell) it was rather simple to define the basic requirements for a viable NRTR publishing system. The system would have to provide concise, mission specific, reports that combined the data outputs from a wide array of sources into a single, cohesive product that was accurate, colorful and appealing, and available on standard size forms. Most importantly the NRTR would have to be publishable immediately after the completion of a test, at little or no extra cost to the test conductor, and would have to be meaningful to top level administrators as well as engineers and scientists. Sounds like a tall order - but with a seemingly endless selection of inexpensive, off-the-shelf desktop publishing hardware and software to choose from, ready access to the vast data collection and display resources at WSMR, and a motivated team of engineering and scientific experts, a prototype NRTR publishing system that meets these basic requirements was implemented and put into operation at WSMR. Details of the implementation of individual elements of the system, as they relate to the fulfillment of the stated basic requirements, will now be examined.

## NRTR DATA SOURCES

It was decided that the report would be based on three major data sources. First, the detailed operational requirements documents (ORs), classification guides, and expected milestone schedules of the project for whom a NRTR was being produced would be used. Second, TSPI data from RADARs and Telemetry being processed and displayed on the Interactive Graphics Display Systems at WSMR would be utilized. These displays provide position plots against detailed map backgrounds, Instantaneous Impact predictions (IIPs), multi-trace axis graphs, animations of three dimensional scale models showing test vehicle attitude, and digital representations of numeric data. The key here was the IGDS' ability to provide hardcopy of all of these display formats on 8.5 x 11 forms, in real-time. And third, optical and video data from field cameras transmitted to a central collection point for storage on video tape, in real-time, would be included. Emphasis would be placed on maximizing use of color, recognizable logos and symbology, graphical and tabular data representations, flowing, variable font and pitch text, and avoidance of overly technical language or unintelligible acronyms. Every attempt would be made to create substantive reports that were unclassified to provide for widest possible dissemination, while maintaining the capability to produce classified reports if the need arose. The overall report would be kept as concise as possible with a maximum length of three printed pages.



## NRTR TEMPLATE GENERATION

Close personal interaction with project engineers and test conductors while examining project ORs, and expected mission milestone scheduling was key to incorporating these data into an NRTR. After intense consultation with these personnel, test background information, discrete test objectives, mission requirements, expected results, and mission milestone progressions were extracted as the most substantive reporting elements. These elements were then assembled into a textual "template" from which the final report would be fashioned. This template was iteratively reviewed by the project representatives and revised by the NRTR production team until a highly refined foundation of pre-mission determinable data had been created. Real-time data from optics and the IGDS could then be inserted, in immediate post-flight, to produce a final report. This process of defining substantive reporting elements, getting the project to decide just exactly what it was they wanted to see in an NRTR, was the most difficult and time consuming segment of NRTR production requiring weeks of preparatory work long before mission T-time. It was time well spent, however, as it would ensure high customer satisfaction and reduce final report generating processes and times to a minimum. In fact, all that would remain to be done in immediate post-flight would be the insertion of key words and measurements into the template text and overlaying of digitized optical and IGDS data into template slots prepared for them.

## IGDS TSPI DATA COLLECTION

A listing of TSPI data milestones, as called for in the NRTR template, would be provided to operations personnel in the WSMR IGDS display area. These individuals would capture the mission events, as they occurred in real-time, on the laser hardcopy printers of the IGDS. A member of the NRTR production team would take those 8.5 x 11 hardcopies, as they were produced, and digitize them using a 600 x 600 dot scanner attached to a 386 PC platform. The results of this digitizing process would be standard TIF files of laser-quality graphics images that could be transferred to a main NRTR production platform were they could be cropped, sized, colored and enhanced for inclusion in the finished report.

## VIDEO/OPTICAL DATA COLLECTION

At the same time another member of the NRTR team would be monitoring video and optical transmissions from the field as they were being taped in the main optical data collection facility at WSMR. A separate set of tapes, one for each active camera, would be made expressly for NRTR production. The NRTR team member would be marking particularly noteworthy frames of optical data as they occurred. Typical examples of such frames would be at launch, intercept, warhead event, or ground impact. As soon as the mission completed, this team member would access those marked frames through a high quality video recorder and digitize them with a video frame grabber attached to a 386 PC platform. The results of this digitizing process would be standard EPS files of photo-quality images that could be transferred to the main NRTR production platform for cropping, sizing and image enhancement similar to that which was applied to the TIF files previously described.

## NRTR FINAL PRODUCTION

While team members worked with the image data, the NRTR team leader would be preparing for final report generation by inserting key wording describing the initial success or failure of the mission, along with specific numeric measurements or assessments and prevailing weather data, into the NRTR textual template. Then TIF files of the IGDS TSPI data would be overlaid into awaiting template positions. Borders, connecting lines and text annotations would be affixed to the TIF images to create composite graphics around which the text of the template would flow. Finally the EPS optical images would be brought into their template positions with appropriate borders and captions being applied as needed. This final report assembly process would be preformed using a general purpose desk-top publishing package running on a 486 PC platform. The final product would then be printed, in Postscript format, on a high resolution, full color thermal wax transfer printer attached to the 486 publishing platform. At an average of twelve minutes per page this would be the most lengthy single process in the production of the NRTR. After printing completed, the original report pages would be reproduced on a high quality color copier as specified by the project.

## NRTR PRODUCTION TIME

The NRTR production time goal would be **two hours** after mission completion. To achieve this goal several noteworthy steps would be taken. Of course, as much work as was possible would be done before the mission ever started. The major processes involved in NRTR production would be done in parallel, on separate PC platforms. Key facets of the NRTR process, from the initiation of IGDS hardcopies to the production of color copies would be handled by specific team members as their sole responsibilities. And, most importantly, the team would practice, practice, practice, going through countless dry-runs where equipment and production logistics would be exercised under actual time and data conditions. Great attention would also be given to logistical contingencies. Each production hardware system would be provided with a hot backup; each production process team member would be prepared to execute using alternate sources and methods; a library of representative photographic and graphic images was built as an emergency source in case field video or IGDS hardcopies could not be collected for some reason. These contingency plans would prove invaluable during the first NRTR production run.

## MAXIMIZING NRTR VALUE

The final goal was to minimize costs to the customer for production of NRTRs. Ideally, this could be achieved by simply defraying the costs of production within the standard rates already being charged for using the WSMR range facilities. The customer would then see no "extra charge" for a substantially useful new data product. It seems as though one might be losing their shirt on a deal like this, but in fact, conditions at WSMR were perfect for the development of this capability without procuring new equipment, soliciting outside expertise or hiring extra personnel. The basic hardware and software systems used to create NRTRs had already been purchased as part of an upgrade to the IGDS display system, and were being used to document Government developed software, and to prepare briefing and presentation materials (see figure 1). Many of the methods and practices employed in NRTR production were actually perfected while the system was being used for this original purpose. A similar system, used for graphics arts production at the WSMR visual information department was also already in operation. It was a simple matter to slightly reconfigure and reassign these systems, neither of which was being 100% utilized, to the purposes of creating NRTRs. There were several Government personnel who were experts in the operation of these systems, and who were top real-time programmers and analysts familiar with the WSMR data collection and display systems. These individuals would make up the NRTR production team and would take on this responsibility as a part of their normal duties. Thus, the creation of a new and substantial capability would be facilitated essentially without additional cost to the Government, or the customer.

# IGDS HOST NETWORK AND DISPLAY FLOW DIAGRAM

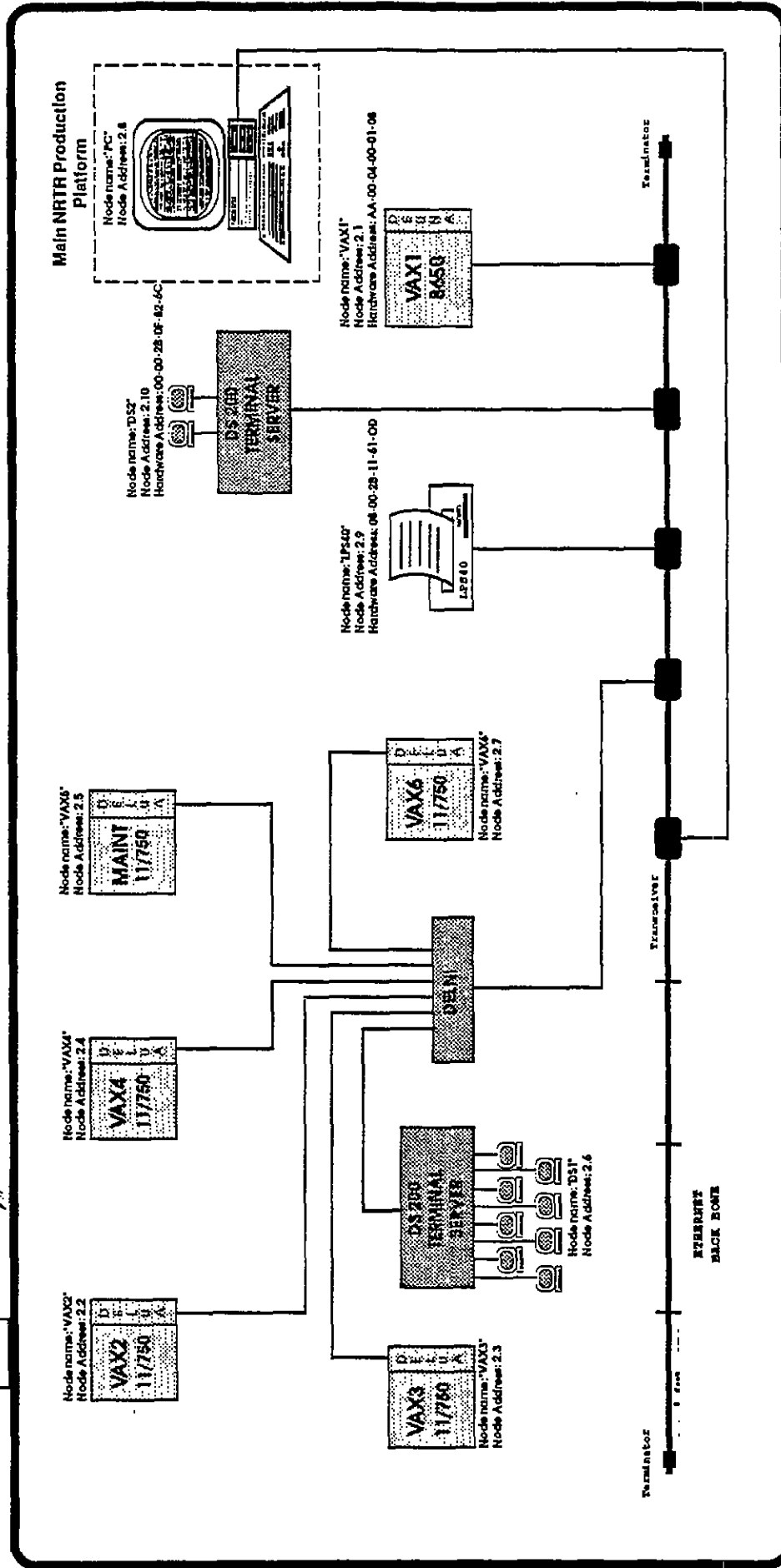
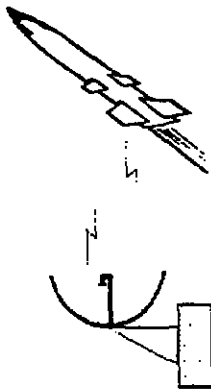
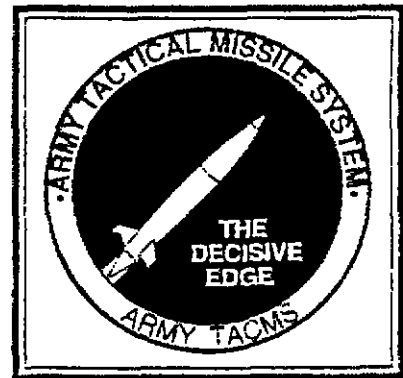

Figure 1

## THE FINAL PRODUCT

The fruition of these concepts, methods, processes and practices that have just been described are the final NRTR. A reborn quick-look report that is packed with data from many sources and flush with color, imagery, photographs and icons. It was meant to be as "commercial" as it was scientific; as much a public relations vehicle as it was a forum for vital test data. It is as appropriate on the desk of an engineer as it is as an inclusion in the most formal Pentagon report. The reports that have been generated so far came out very nicely and created quite a stir among users and customers of WSMR. The reports have been described by many as "brochures" or "magazines" - a testimony to their quality and appeal. The appendices at the end of this document show some examples of NRTRs that were generated during the development of the template for the first real NRTR customer - the Army Tactical Missile System (Army TACMS).

The progression of overall concept development from the first template (appendix A), to the finished product (appendix C) is quite evident, as is the movement to greater information density, succinctness, and "openness". It should be noted that the sample of appendix C is a copy of the first actual NRTR that was ever produced at WSMR. This NRTR was made on 14 April, 1992 immediately following an Army TACMS full production test using exactly the methodologies that have just



been described. The two hour production time goal was actually exceeded such that there was time to go back and make small changes to the finished product - a little extra polish (recall that the original plan called for a "once through" approach to meet the time line)! Several wonderful examples of Murphy's Law were experienced, to the extent that if we had not had "hot" hardware backups, production would have been impossible. Unusual failures or temporary "glitches" in the type of PC equipment that was being utilized is actually very common, and can usually be corrected by rebooting or resetting systems. These are slow recovery procedures, however, and the value of hot spares to address this problem cannot be overstressed. Production of the NRTR of 14 April was an unqualified success that launched the NRTR product into visibility and demand as a new and desirable data product. Before he left WSMR after completion of his mission, the Army TACMS PM had twenty full-color copies of an NRTR, created largely from his personal input. He distributed these copies to his personnel, contractor representatives, congressional staffers and a host of other interested parties all over the country where they began making their way into formal reports and presentations of all kinds.

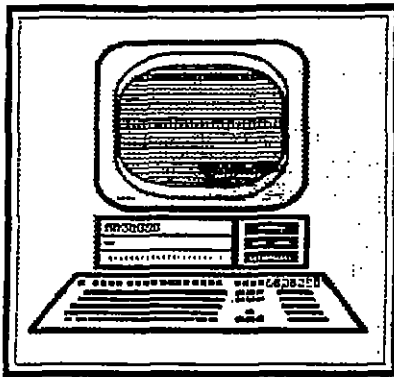

## NRTR PRODUCTION SYSTEM COMPONENTS

The hardware and software components of the NRTR production systems were selected from standard, off-the-shelf, personal computer products that are readily available from a variety of vendors. The main NRTR assembly platform was a 486, 33 Mhz PC with 8 megabytes of RAM and a super-VGA color monitor. The main platform supported a NEC colormate PS thermal wax transfer printer with 8 megabytes of local RAM, 300 x 300 dot resolution and maximum text only print rate of about 1 page per minute. This platform was running MSDOS 5.0 and Microsoft Windows 3.0 as operating system and graphical user interface. The actual report creation was accomplished using Aldus Pagemaker 4.0 which proved to be an amazingly capable and versatile desktop publishing utility. As shown in figure 1, the main system was connected to the IGDS host computer network where it could take advantage of laser printing, mass storage, and other large system resources that were available there. The graphics imaging platform was a 386, 25 Mhz PC with 2 Megabytes of RAM running the same DOS and Windows as the main platform. This system supported a Microtek Scanmaker 600G, 600 x 600 dot resolution, greyscale scanner being controlled by the Photostyler utility. The video and photographic imaging platform was identical to the graphics imaging system. This PC supported a Hauppauge Win/TV video capture unit being controlled by the Photoshop utility. Image files were transferred between the systems using 3.5 inch, 1.4 megabyte floppy disks.

## CONCLUSION

With the success of the 14 April NRTR, this new kind of reporting has begun to take its place among the many fine data products produced at WSMR. Each week another customer asks for a demonstration of the NRTR production system, and many have written the requirement for one into their ORs. Many others have initiated working dialogues with WSMR to begin development of templates to facilitate the production of NRTRs for their tests in the near future. The NRTR production team will continue to refine and enhance its reporting systems and has already begun planning and specifying the NRTR system of the future. A system based on work-station technologies will allow the integration of all the NRTR production processes into a single system, provide for revolutionary NRTR production times approaching 30 minutes, and the inclusion of target motion resolution and other complex reduced data into the NRTR. For now the NRTR production team will look forward to serving its ever growing customer base by providing the very best data products and services available anywhere in the U. S. Army.

## EPILOGUE - After A Year of Production

It has been a little more than a year since the first WSMR NRTR was produced and a great deal of progress and change in this rediscovered arena continues to take place. Initially, interest waned after the fanfare surrounding the ATAMCS NRTR of April 1992. Soon, though, the word was out and by the end of calendar year 1992 there were more requests for NRTR template development than could be processed. Since then a steady stream of test conductors have taken advantage of this new product and have come away as satisfied NRTR customers. About thirty NRTRs have been produced in the last fifteen months, for some ten different projects including Army TACMS, ARMY Hawk, Army ERINT, MLRS TGW and SADARM, Army Patriot, and TMD. This translates to an average NRTR production load of two reports per month, which is about all the currently available equipment and manpower can handle. The process itself has been steadily refined and tuned with several reports produced well under the guaranteed two hour production time with a "world record" time on one MLRS NRTR of one hour 37 minutes. A new data reduction process has been recently developed to replace the manually intensive and sometimes low resolution method of scanning axis and map plots for importation into the NRTR publishing software. This process takes digital graphics display data logged on the hard disks of the IGDS host systems (fig. 1) and transmits them via a fiber optically coupled network link to a remotely located Decstation 5000 workstation. This station takes raw data and produces map and axis plots in Encapsulated Postscript format and returns them, via the network, to the NRTR assembly station where they can be directly imported into the publishing software. This capability represents an important successful first step toward the total automation of the reporting process and its assumption into a truly merged real-time data processing, display, reduction and reporting system. Perhaps the most important lasting result of this whole endeavor has been the intense and widespread interest it has spurred in speeding up and integrating data reporting in general. At WSMR at least three high level working groups are moving on incorporating and expanding on the concepts proven through these first NRTRs for processes throughout the Range in a continuing effort to maximize customer service and satisfaction through better, more timely and more cost effective test and evaluation data products.

**Appendix A**  
*First NRTR template*





**Immediate Postflight  
Synopsis of Mission  
Data for**



**ATACMS Operation AB  
Performed on  
29 May, 1991**

at

**White Sands Missile Range, NM**

Initial Mission Assessment: **FULLY SUCCESSFUL**

*ATACMS operation AB was fired from launcher 351 at LC 33 ,for intended impact within the 90 mile impact area, on 29 May, 1991.*

*Launch was nominal, at an angle of approximately 55 degrees. Optical , IMU and RADAR tracking data were nominal from launch.*

*Weather conditions were nominal .*

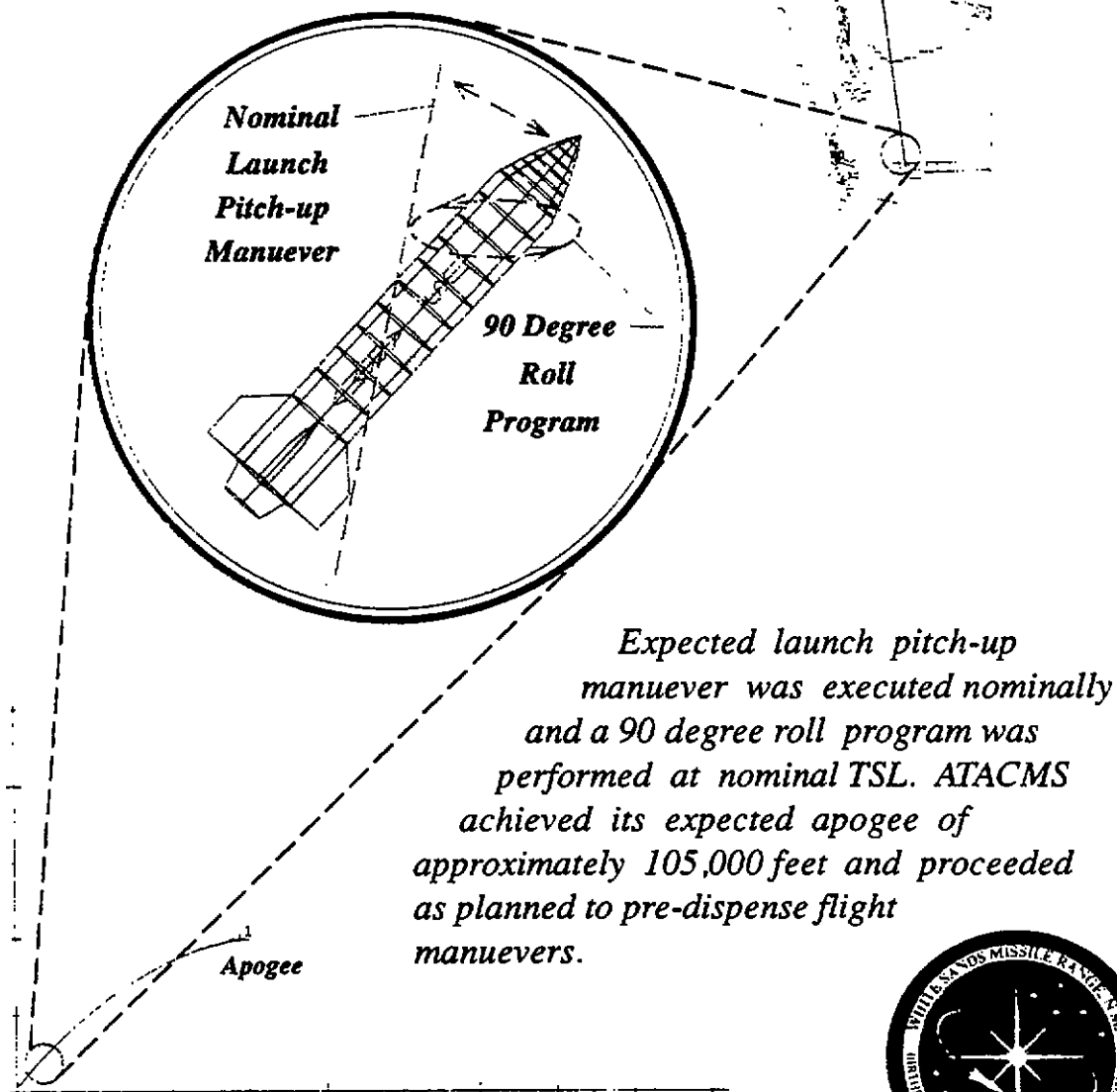

*Expected launch pitch-up maneuver was executed nominally and a 90 degree roll program was performed at nominal TSL. ATACMS achieved its expected apogee of approximately 105,000 feet and proceeded as planned to pre-dispense flight maneuvers.*



*ATACMS performed nominal pitch-down to level flight maneuvers over the intended impact area and proceeded to a nominal submunitions dispense event at expected TSL.*

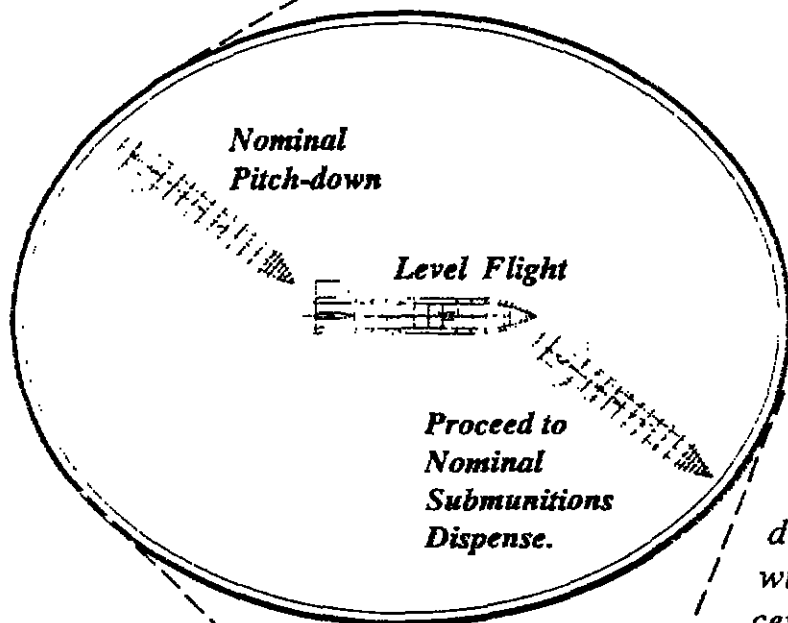

*ATACMS submunitions dispersal was nominal with impact footprint centered at :  
Latitude - 33.59  
Longitude - 106.58  
Within the intended Target area .*

*Mission Assessment: ATACMS Operation AB Was Fully Successful With Majority Of Mission Objectives Achieved*



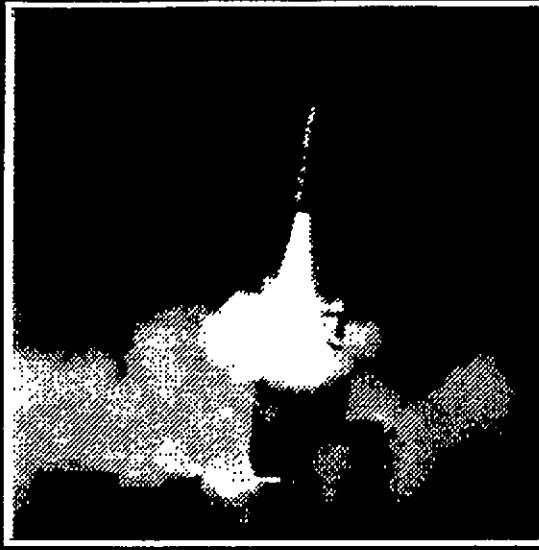

## LAUNCH

*Nominal launch of ATACMS operation AB on 29 May, 1991*

*Image taken from optical data gathered at launch site*

## DISPENSE

*Nominal ATACMS operation AB submunition dispense event.*

*Image taken from video data gathered near impact area.*

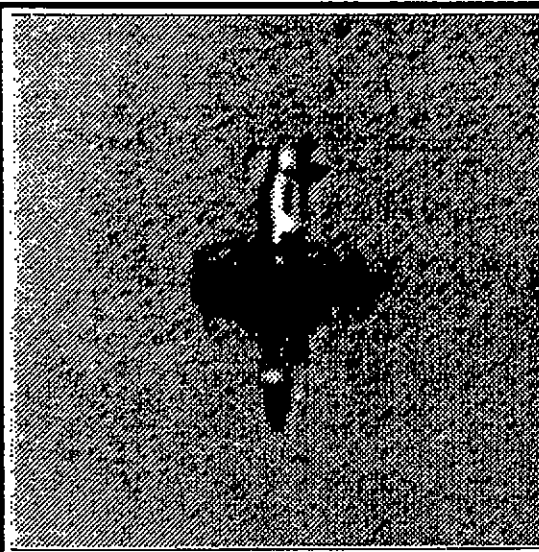
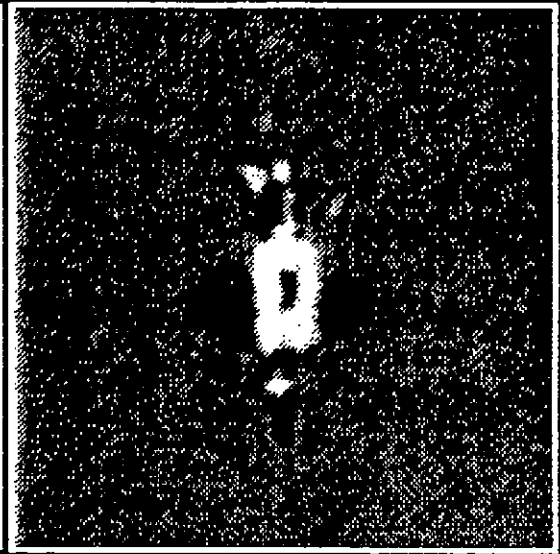

## DISPERSION

*Nominal ATACMS operation AB submunition dispersion.*

*Image taken from video data gathered near impact area.*



**Appendix B**  
*Refined NRTR Template*

UNCLASSIFIED



# Immediate Test Report for Army TACMS Low Rate



## Initial Production Validation Test 29 May, 1991

**BACKGROUND:** *Second of three firings of early production missiles. These were identical to those used in Operation Desert Storm.*

**TEST OBJECTIVES:**

- Demonstrate -*
- Off-the-side launch.*
- Performance and accuracy.*
- New electronic safe/arm fuse (ESAF).*

**MISSION REQUIREMENTS:**

RANGE	MISSILE TEMP.	OFF-AXIS TO TGT	LAUNCHER POSITION	WARHEAD PAYLOAD	WARHEAD PATTERN	LLM POS'N (Amils)
LONG	AMB	L3	PITCH-UP 5 deg.	LIVE	MED	OTS-R +i840

**RESULTS:** *Off-the-side launch and flight performance were as expected. Intended target area was reached and submunitions were dispensed normally with expected accuracy achieved. ESAF performed as designed. Mission was on schedule and within budget. All mission objectives were met.*

Preliminary data indicates mission was : **FULLY SUCCESSFUL**

UNCLASSIFIED

**UNCLASSIFIED**

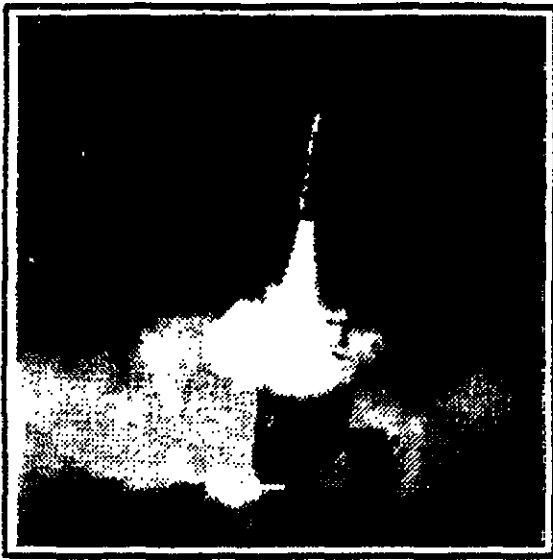

Army TACMS flight 46 (WSMR operation AB) was fired off-the-side from a standard MLRS launcher at Launch Complex 33, for intended impact within the 90 mile impact area.

Launch was normal with initial flight proceeding as planned. RADAR tracking, Telemetry data, and Optical data were nominal from launch.

Off-the-side launch of Army TACMS from MLRS launcher

Average weather conditions at the launch and target sites prevailed with light SW winds, less than 5 MPH, and unlimited visibility down-range.

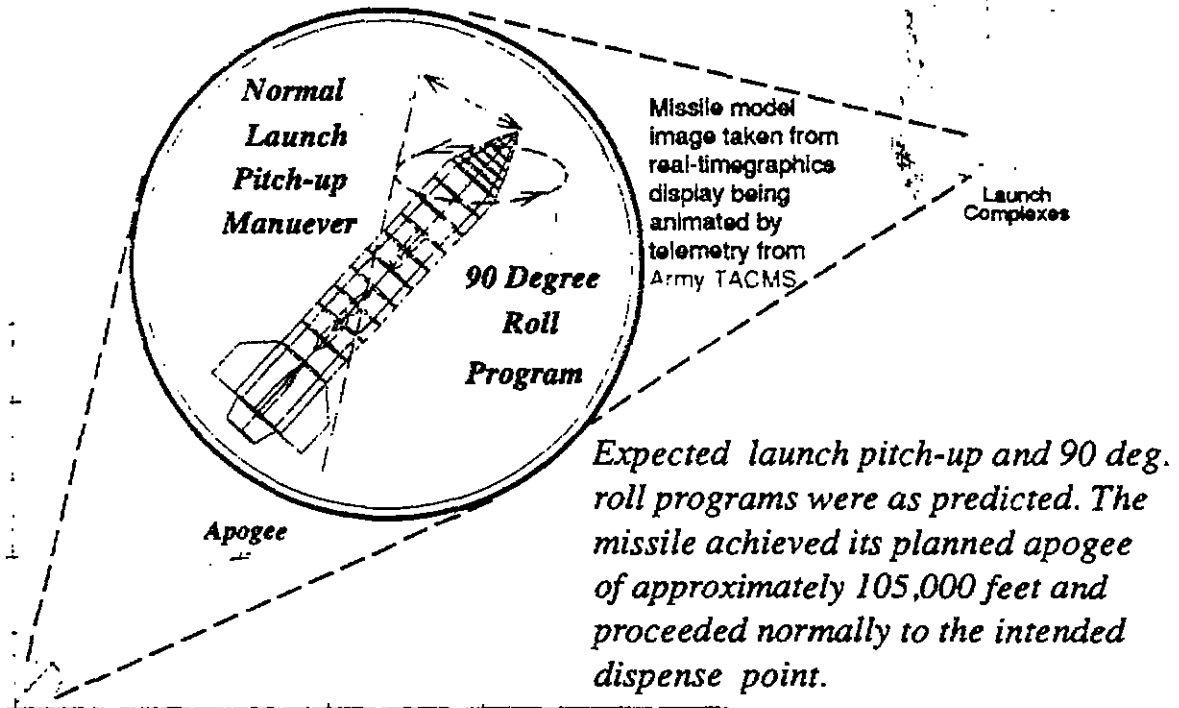

**UNCLASSIFIED**

**UNCLASSIFIED**

*Army TACMS performed planned pitch-down to level flight maneuvers over the intended target area and proceeded to a submunitions dispense event as expected.*

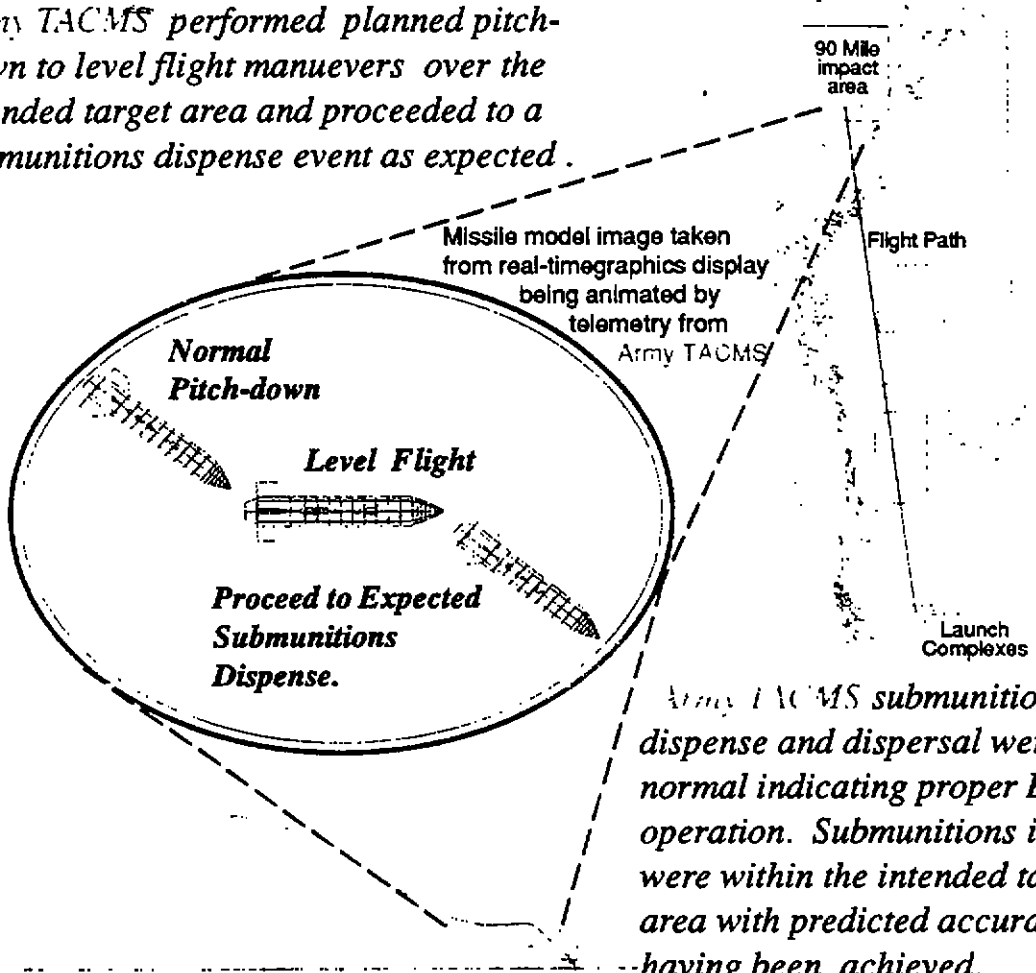

*Army TACMS submunitions dispense and dispersal were normal indicating proper ESAF operation. Submunitions impacts were within the intended target area with predicted accuracy having been achieved.*

***DISPENSE***

<b>Table of Flight Parameters</b>	
Max Altitude	105,000 ft.
Max Velocity	1,500 ft/sec
Down-Range Distance	80 km
Dispense Altitude	30,000 ft

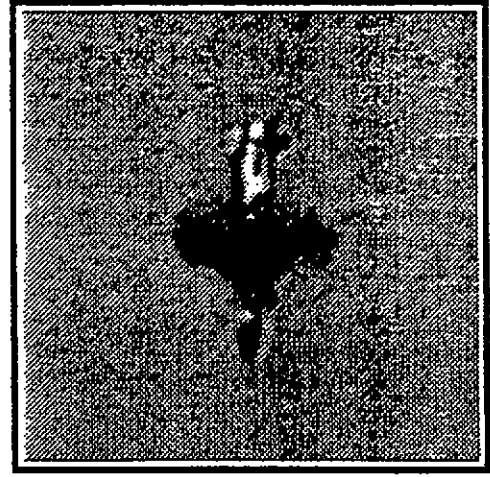

Successful dispense of Army TACMS submunitions

**UNCLASSIFIED**



**Appendix C**  
*First Actual NRTR*



# Immediate Test Report for Army TACMS Full Production Test 14 April, 1992



**BACKGROUND:** *Third firing of early full scale production missiles .  
This was a Block I , Phase II missile - indicating  
that the warhead contained live M74 bomblets .*

**TEST OBJECTIVES:** *To Evaluate -*

- *Missile/Launch Pod Assemblies (M/LPAs) and M270 launcher hardware and software interfaces in an off-the-side firing scenario.*
- *Aerodynamic and propulsion performance.*
- *Blast effects of M270 launcher.*
- *Guidance system performance.*
- *Warhead performance (arming, dispersion, dud rate).*

**MISSION REQUIREMENTS:**

RANGE	MISSILE TEMP.	OFF-AXIS TO TGT	LAUNCHER POSITION	WARHEAD PAYLOAD	WARHEAD PATTERN
SHORT	AMB	NONE	PITCH-UP 1 deg.	LIVE	LARGE

**RESULTS:** *Off-the-side launch and flight performance were as expected.  
Warhead arming was normal. Intended target area was reached  
and submunitions were dispensed normally with planned in-  
flight dispersion achieved. Mission was on schedule and within  
budget. All in-flight mission objectives were met.*

**Preliminary data indicates mission was : SUCCESSFUL**



Off-the-side launch of Army TACMS from M270 launcher

Army TACMS flight 54 (WSMR operation AE) was fired off-the-side from a standard M270 launcher at Deerhorn site, for intended impact within the Denver Wit impact area.

Launch was normal with initial flight proceeding as planned. RADAR and interferometer tracking data were nominal from launch. Telemetry data from the missile

was received normally.

Average weather conditions at the launch and target sites prevailed with light NE winds, less than 6 Knots, and unlimited visibility down-range. These conditions facilitated full optical coverage of the entire mission.

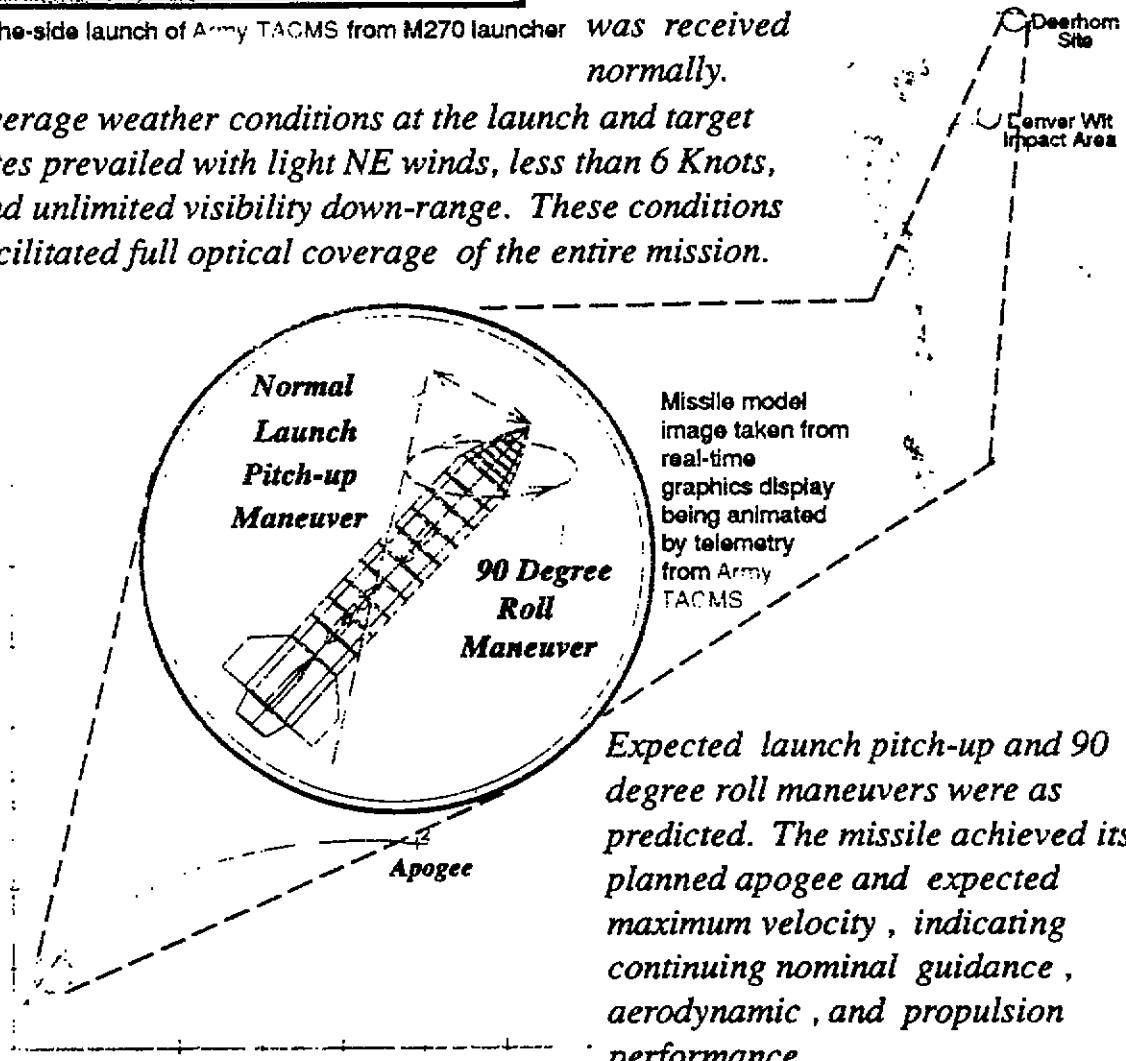

Expected launch pitch-up and 90 degree roll maneuvers were as predicted. The missile achieved its planned apogee and expected maximum velocity, indicating continuing nominal guidance, aerodynamic, and propulsion performance.

Army TACMS performed planned pitch-down flight maneuver over the intended target area and proceeded to a submunitions dispense event as expected, indicating further nominal guidance, propulsion and aerodynamic performance.

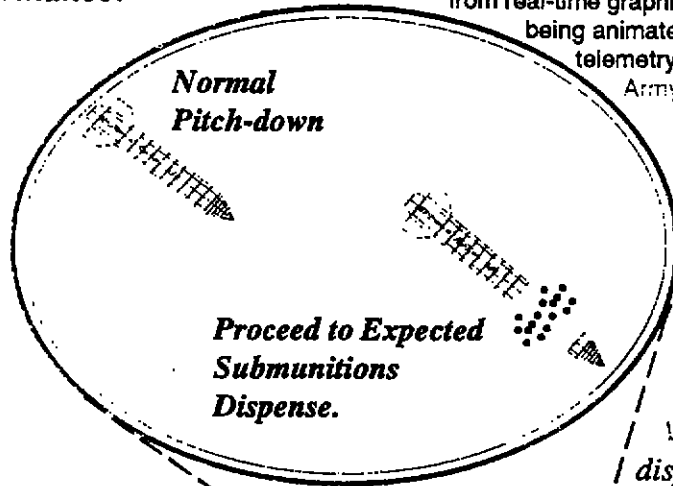

Missile model image taken from real-time graphics display being animated by telemetry from Army TACMS

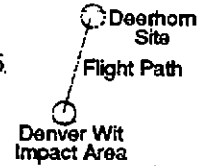

Army TACMS submunitions dispense and in-flight dispersal were normal indicating proper warhead arming. Submunitions impacts were within the intended target area with predicted flight accuracy having been achieved. Actual submunition dispersal and dud rate will be determined through ground surveys.

<b>Table of Flight Milestones</b>	
Max Altitude	Normal
Max Velocity	Normal
Down-Range Distance	Normal
Dispense	Normal
Ground Impact	Normal

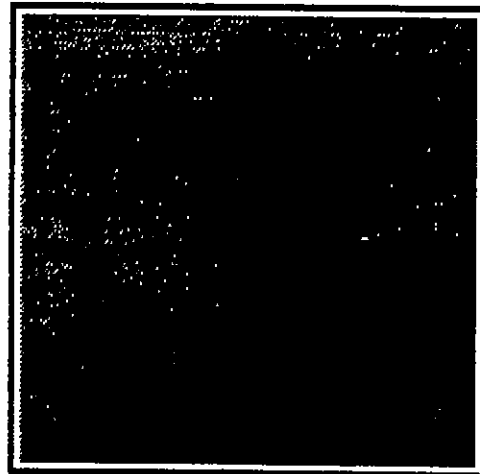

Successful dispense of Army TACMS submunitions

# DESKTOP DATA ANALYSIS



RANGE DIRECTORATE  
NAWCAD, PAX RIVER, MD

*Data Reduction Initiatives*

# Future Data Reduction Approach

Wide Area Network



Local Area Network

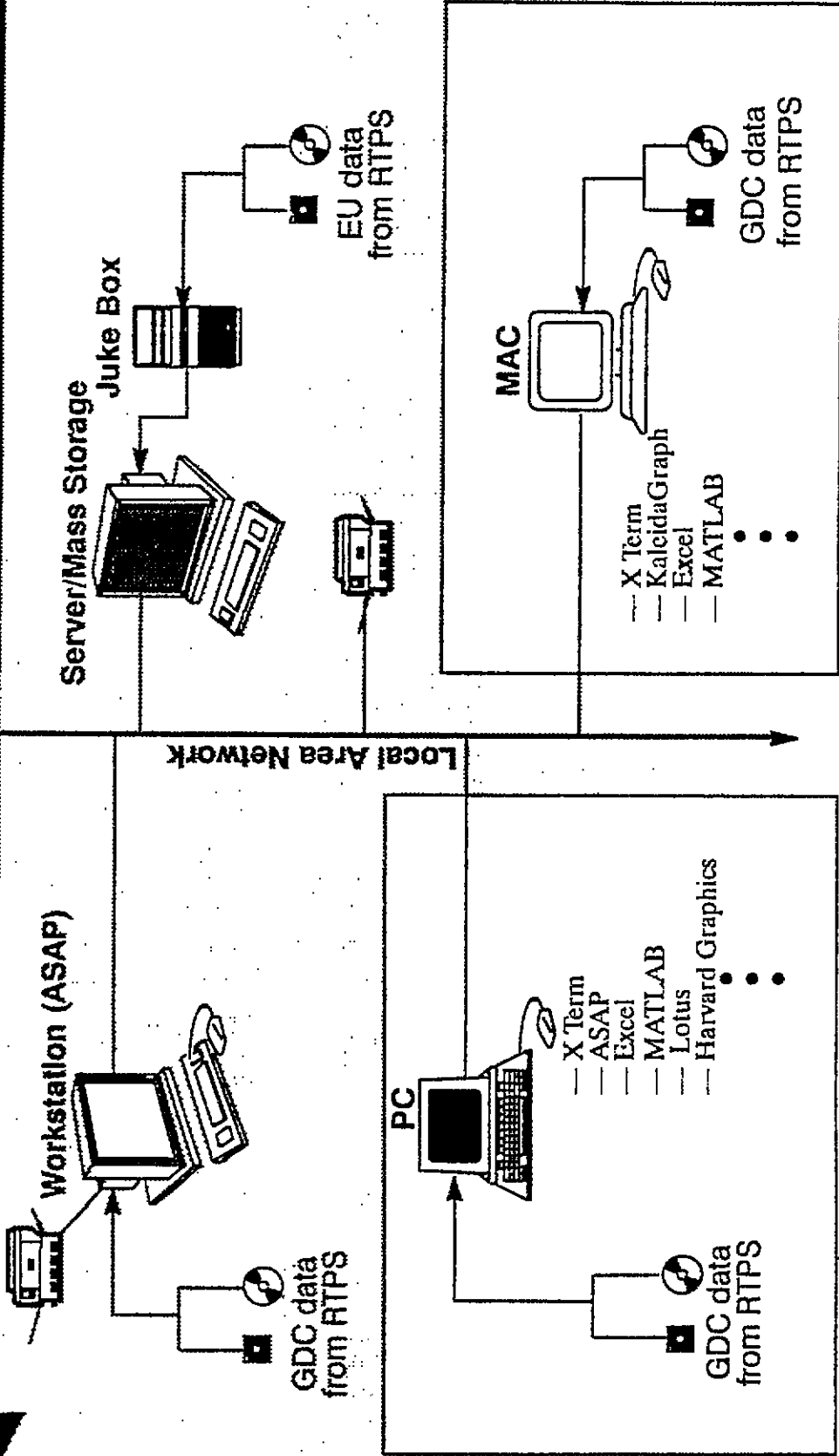

Workstation (ASAP)

Server/Mass Storage  
Juke Box

GDC data  
from RTPS

EU data  
from RTPS

PC

MAC

GDC data  
from RTPS

GDC data  
from RTPS

- X Term
- ASAP
- Excel
- MATLAB
- Lotus
- Harvard Graphics
- 

- X Term
- KaleidaGraph
- Excel
- MATLAB
- 

**Legend**

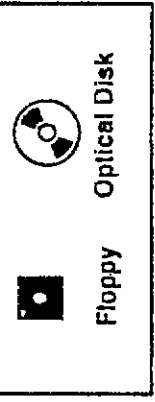

Floppy

Optical Disk

# ASAP

## Advanced Scientific Analysis Package

An easy-to-use, menu-driven software system designed to assist the engineer in editing, reducing and displaying large amounts of flight test data.

ASAP can be utilized on any computer system that supports SAS. These include:

- Personal Computers
- Sun, Apollo, HP, VAX, & SGI Workstations
- Mainframe Computers

ASAP is actually a series of software modules built around the commercially-available Statistical Analysis System (SAS). SAS was chosen as the core software because of its relational database structure, wide variety of data analysis capabilities, menu-driven structure, and graphical display techniques.

# ASAP

## Advanced Scientific Analysis Package

With ASAP, the engineer can perform a wide variety of analyses, including:

- data validation and verification  
(cross plots, autoscaling, windowing, parameter selection/viewing, etc.)
- highly interactive analyses
- statistical analysis
- *Rainflow* analysis
- 3-D rotations
- time history displays
- X-Y plots
- min/max analysis
- spectral analysis
- any user-requested techniques and plot formats



## **Additional Tools**

- Multi-media Data Support (MDS) provides connectivity to commercial off-the-shelf software:

- Excel
- Data Probe
- Harvard Graphics
- Lotus
- KaleidaGraph
- Sigma Plot
- MATLAB

and prime contractor specified formats.

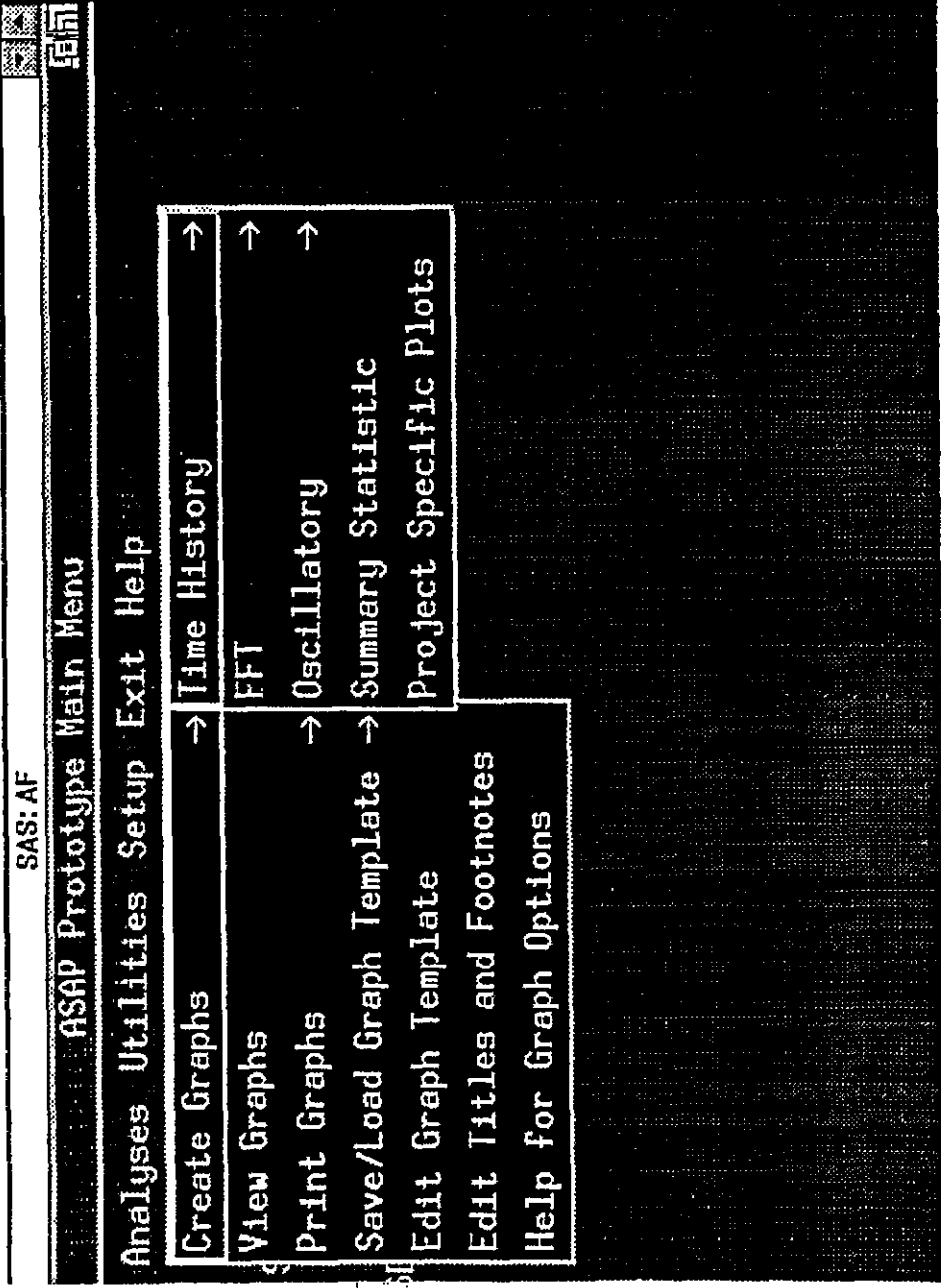

Windows

Graphs Report Analyses Utilities Setup Exit Help

Create Graphs	→ Time	Time History Technical Report
View Graphs	FFT	1 Column of 8 Time Histories
Print Graphs	→ Oscil	2 Columns of 4 Time Histories
Save/Load Graph Template	→ Summe	Cross
Edit Graph Template	Proje	Air 530
Edit Titles and Footnotes		Air 530 scales based on 10
Help for Graph Options		Y22 4 Time Histories

Maneuver Code:

█

TECHNICAL REPORT - TIME HISTORY(1X8)

Project V22 Demo Flight 2 Event 35 Graph Number 112

Options Titles & Footnotes

Parameter #	Parameter Name	Parameter Info	Parameter #	Parameter Name	Parameter Info
1	[REDACTED]	List	2	List	Info
3		List	4	List	Info
5		List	6	List	Info
7		List	8	List	Info

X-Axis Increment: 2 X-Axis Tick Marks: .  
Graph Start Time: 7:11:21.0289 Graph Stop Time: 7:11:43.8359  
Event Start Time 7:11:21.0289 Event Stop Time 7:11:43.8359

OK Go Back Cancel Help

**GRAPH OPTIONS**

X Axis Major Grid

Off

On

X Axis Minor Grid

Off

On

Y Axis Major Grid

Off

On

Y Axis Minor Grid

Off

On

X Log

Off

On

Y Log

Off

On

Y Axis Labels

Full

Mnemonics

Print Orientation

Portrait

Landscape

Symbols:

List

Interpolation:

List

Curve Fit:

List

OK

Cancel

**Interpolation:**

None  
Join  
Smooth

**Symbol List:**

None  
X  
Plus  
Star  
Triangle (hollow)  
Square (hollow)  
Square (filled)  
Circle (hollow)  
Circle (filled)

**Curve Fit:**

None  
1st order  
2nd order  
3rd order

TITLES & FOOTNOTES FOR CURRENT GRAPH ONLY

=====  
=====  
Titles

=====  
=====  
Project Info Lines

- 1. \_\_\_\_\_
- 2. \_\_\_\_\_

Flight Info Lines

- 3. \_\_\_\_\_
- 4. \_\_\_\_\_

Event Info Lines

- 5. \_\_\_\_\_
- 6. \_\_\_\_\_

=====  
=====  
Footnotes

- 1. \_\_\_\_\_
- 2. \_\_\_\_\_

# Time History Technical Report 1x8

Title line 1  
 Title line 2  
 Title line 3  
 Title line 4  
 Title line 5  
 Title line 6

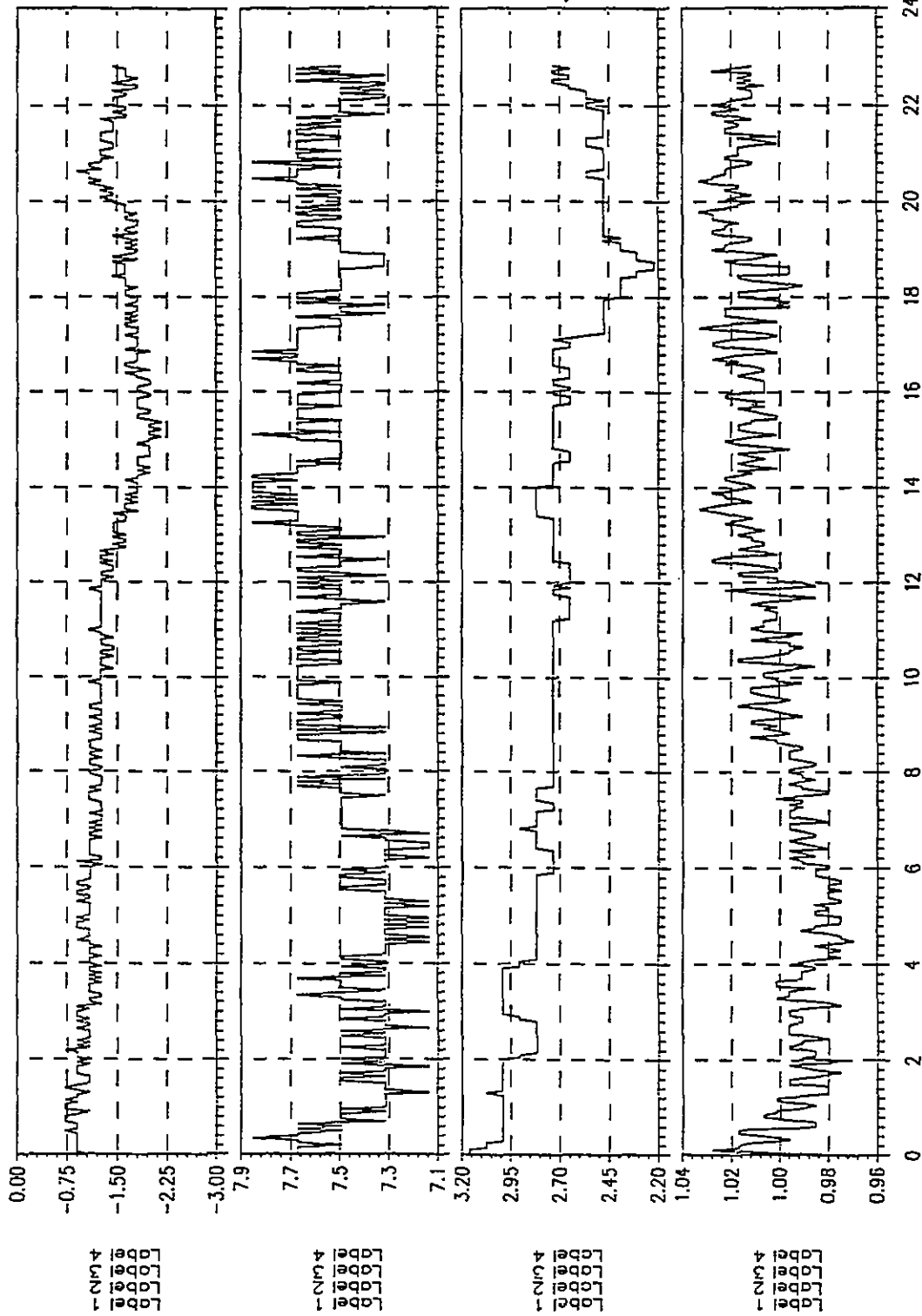

Time(Seconds)  
 Footnote line 1  
 Footnote line 2

Graph Start Time: 7:11:21.0289  
 Event Start Time: 7:11:21.0289

Graph Stop Time: 7:11:43.835  
 Event Stop Time: 7:11:43.839

# Time History 2x4

TIME HISTORY 2X4

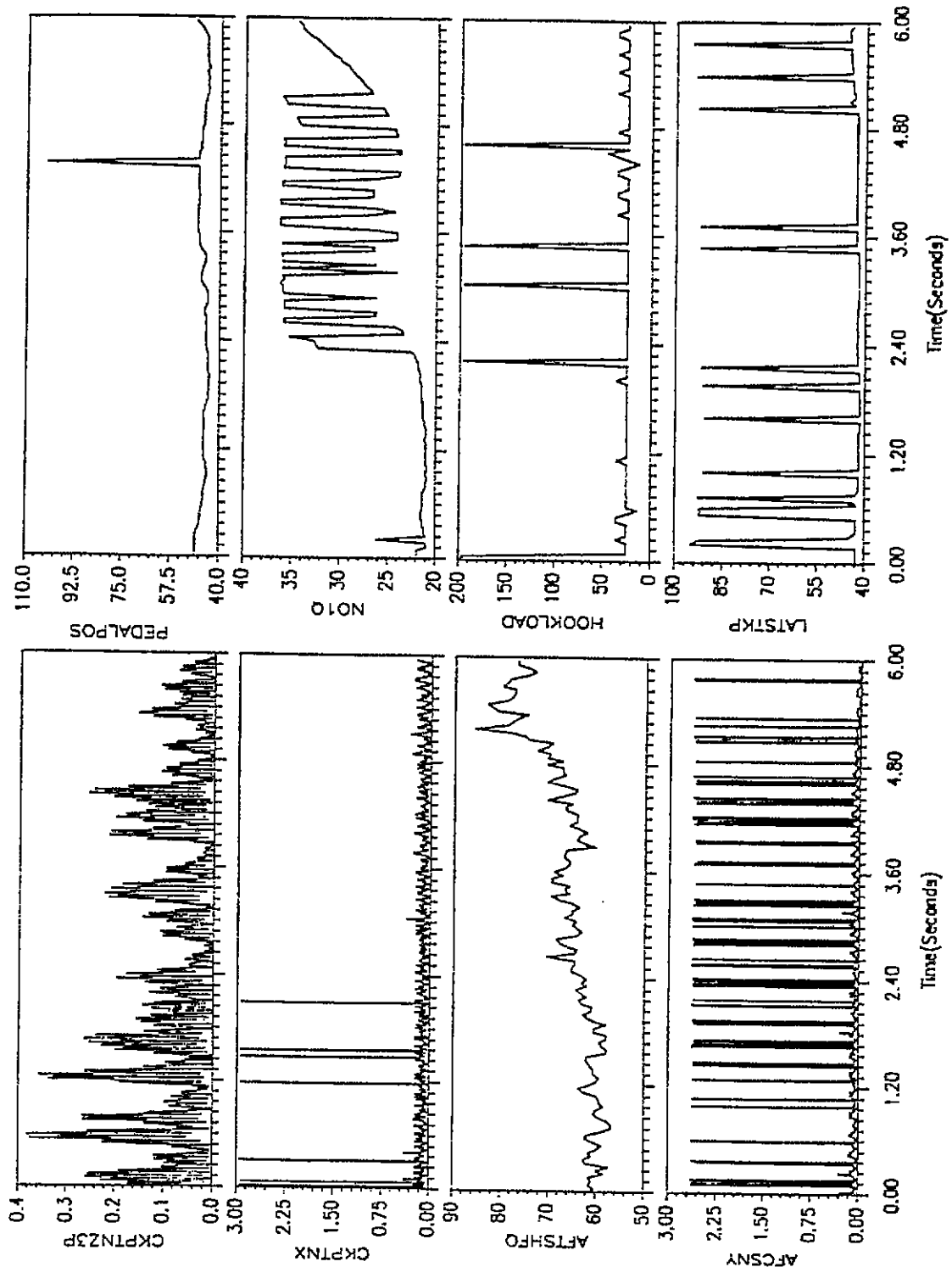

Event Number 01

Graph Start Time: 18:09:29.0549  
Event Start Time: 18:09:29.0549

Graph Stop Time: 18:09:35.00  
Event Stop Time: 18:09:35.00



# V-22 Time History

Graph Begin Time: 18:09:29.055  
Event Begin Time: 18:09:29.055  
Graph End Time: 18:09:35.010  
Event End Time: 18:09:35.010

data

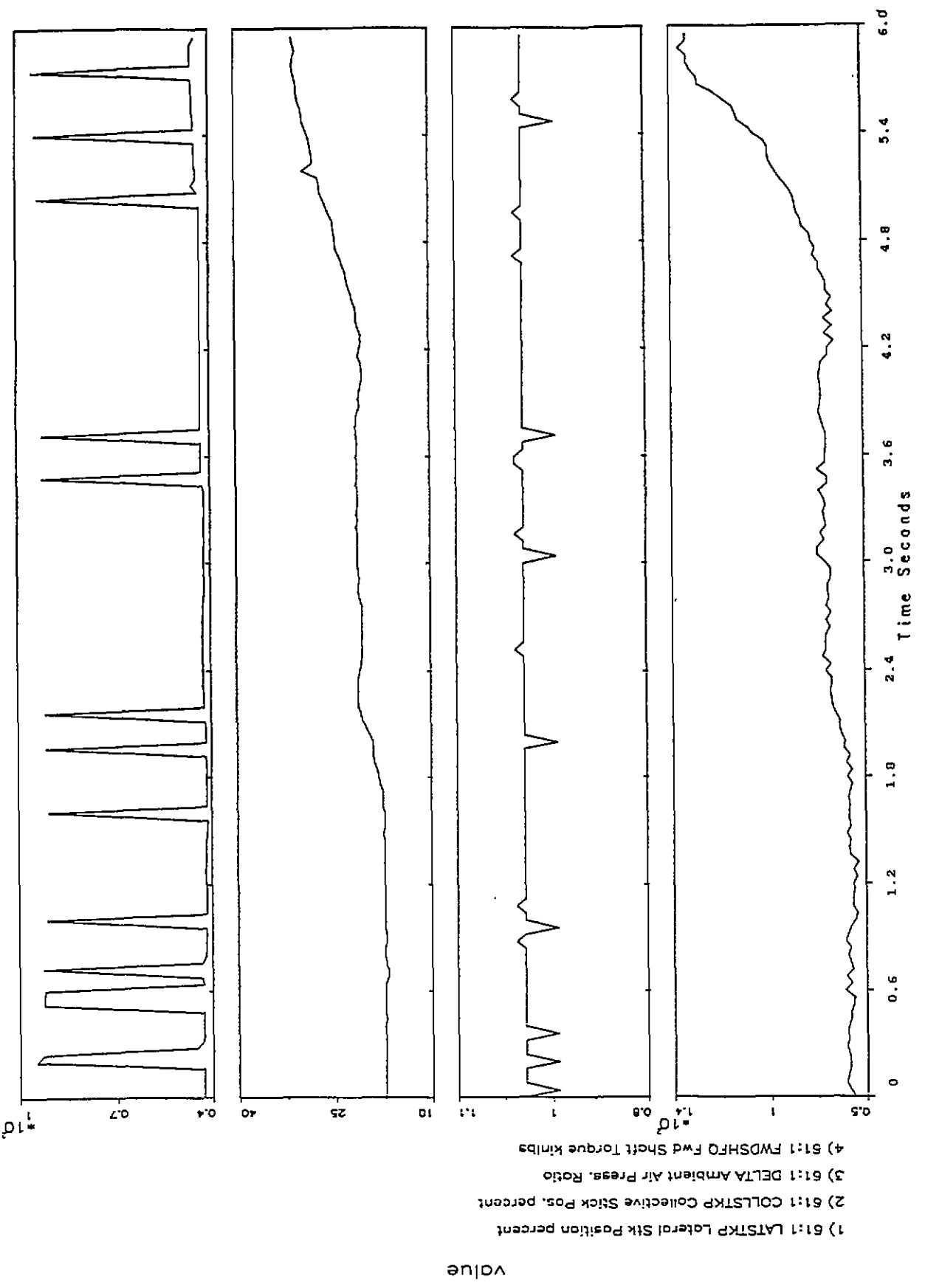

# FFT Frequency Domain / Time History

FFT FREQUENCY DOMAIN/TIME HISTORY

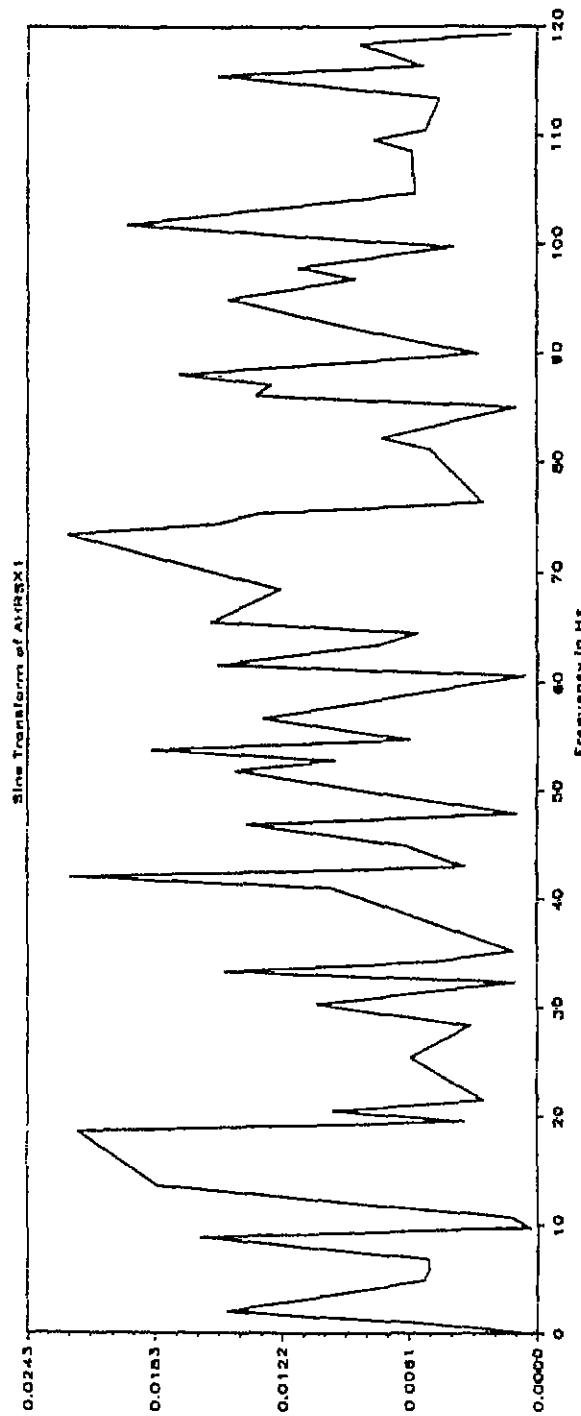
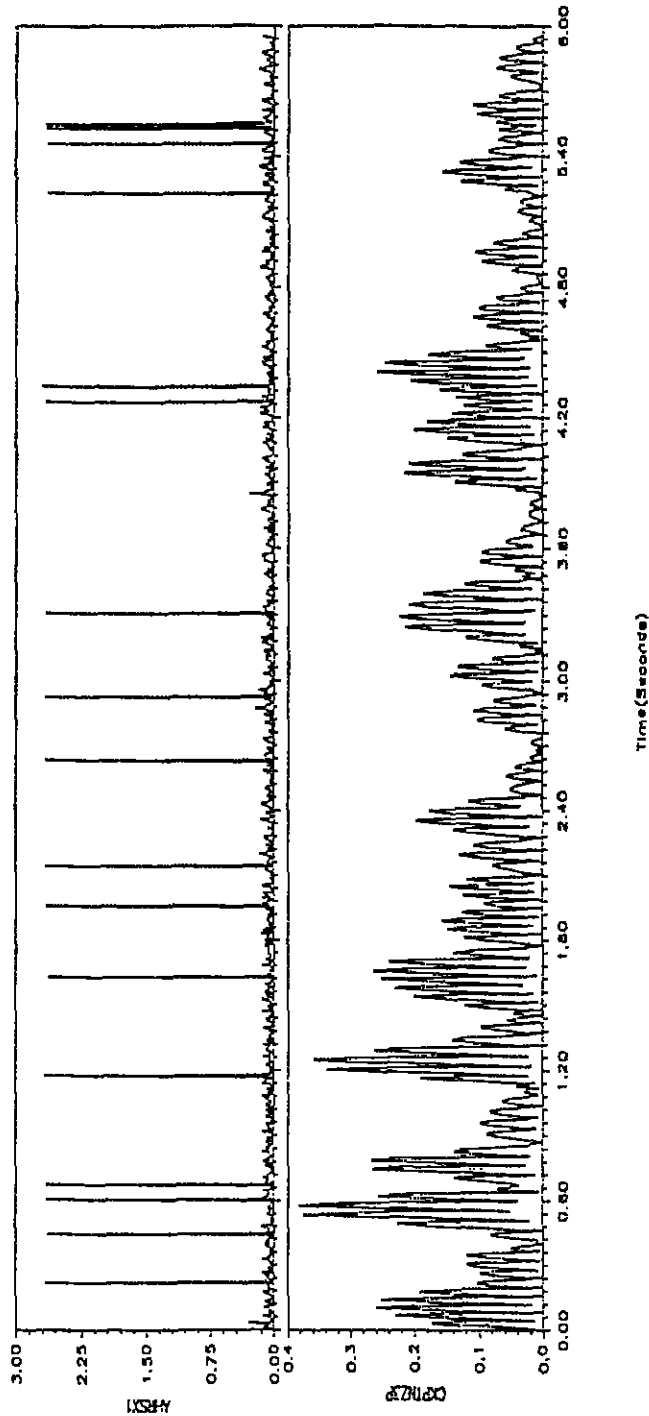

Date has been dimensioned  
 FFT End Time 18:09:35.010  
 Event End Time 18:09:35.010

Rectangular Window used on 200.378 sample/second Data  
 Event Number 01

288 Points Used in 5 FFTs with 0 s Overlay  
 Frequency Resolution = 0.978  
 FFT Begin Time 18:09:29.055  
 Event Begin Time 18:09:29.055

# Summary Statistics for Maximum

DEMO PROJECT  
DEMO-01 BuNo 123456  
Flight Number 10A on 13MAY90

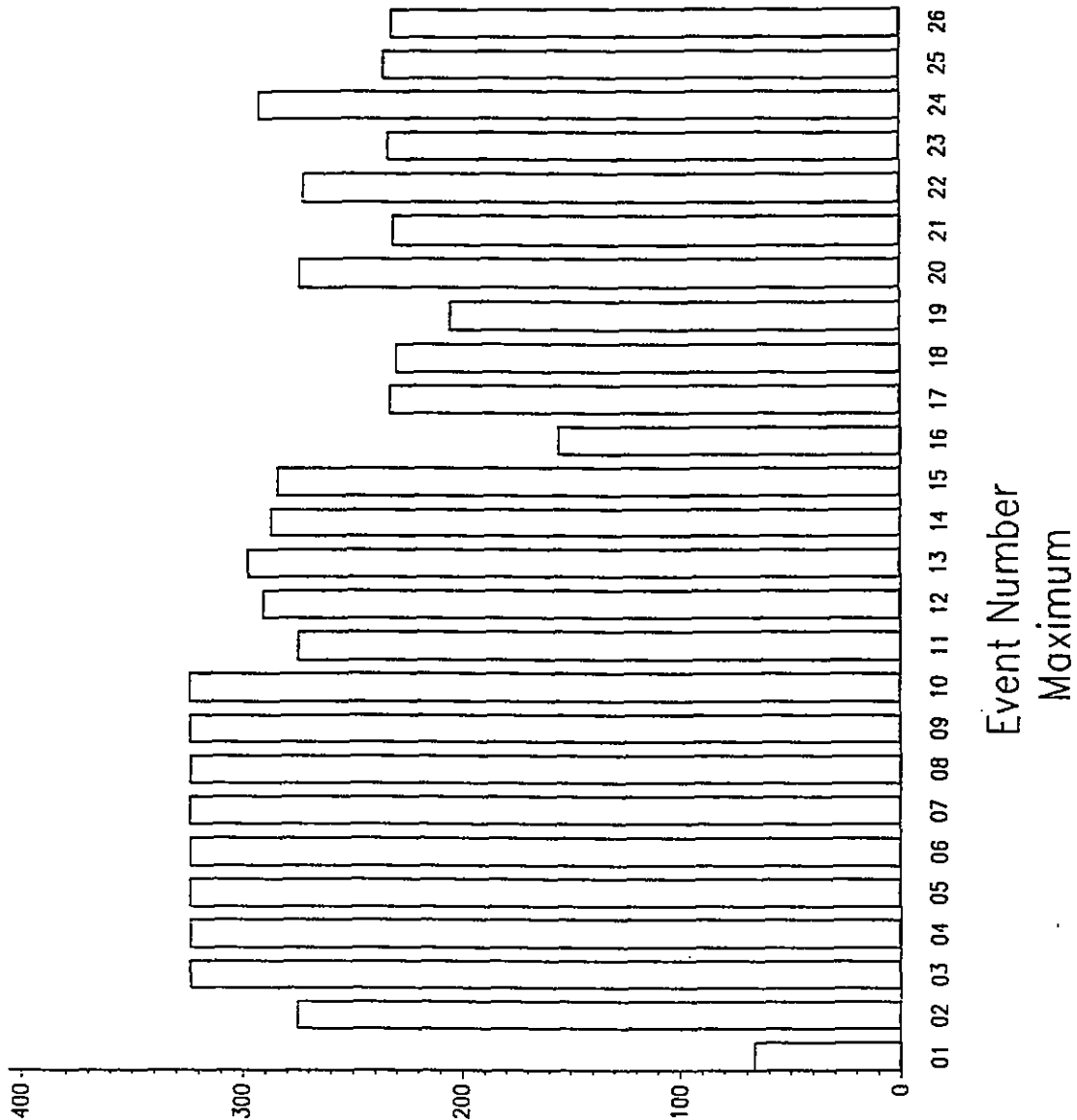

# Summary Statistics for minimum

DEMO PROJECT  
DEMO-01 BuNo 123456  
Flight Number 10A on 13MAY90

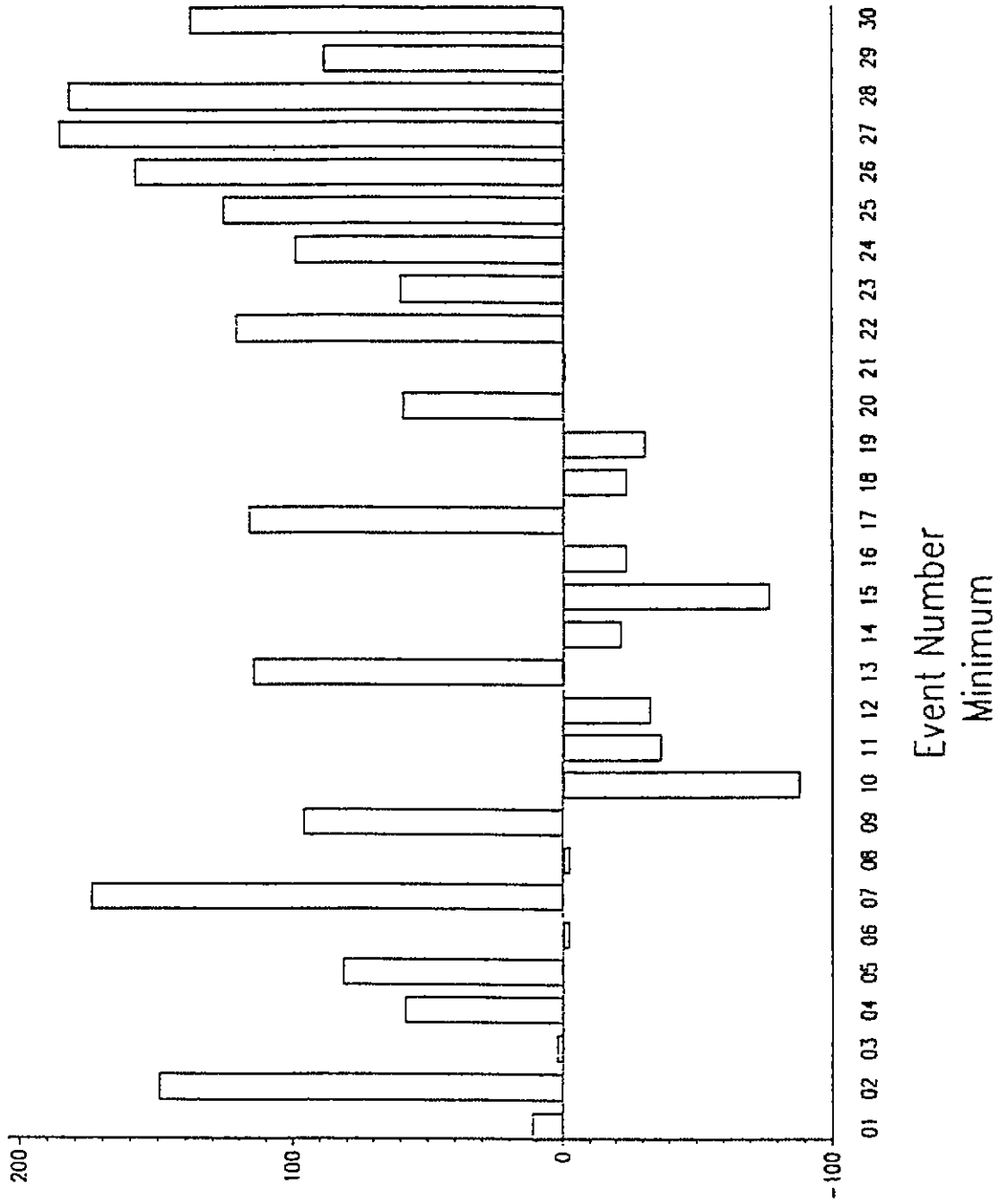

# Summary Statistics for Range

DEMO PROJECT  
DEMO-01 BuNo 123456  
Flight Number 10A on 13MAY90

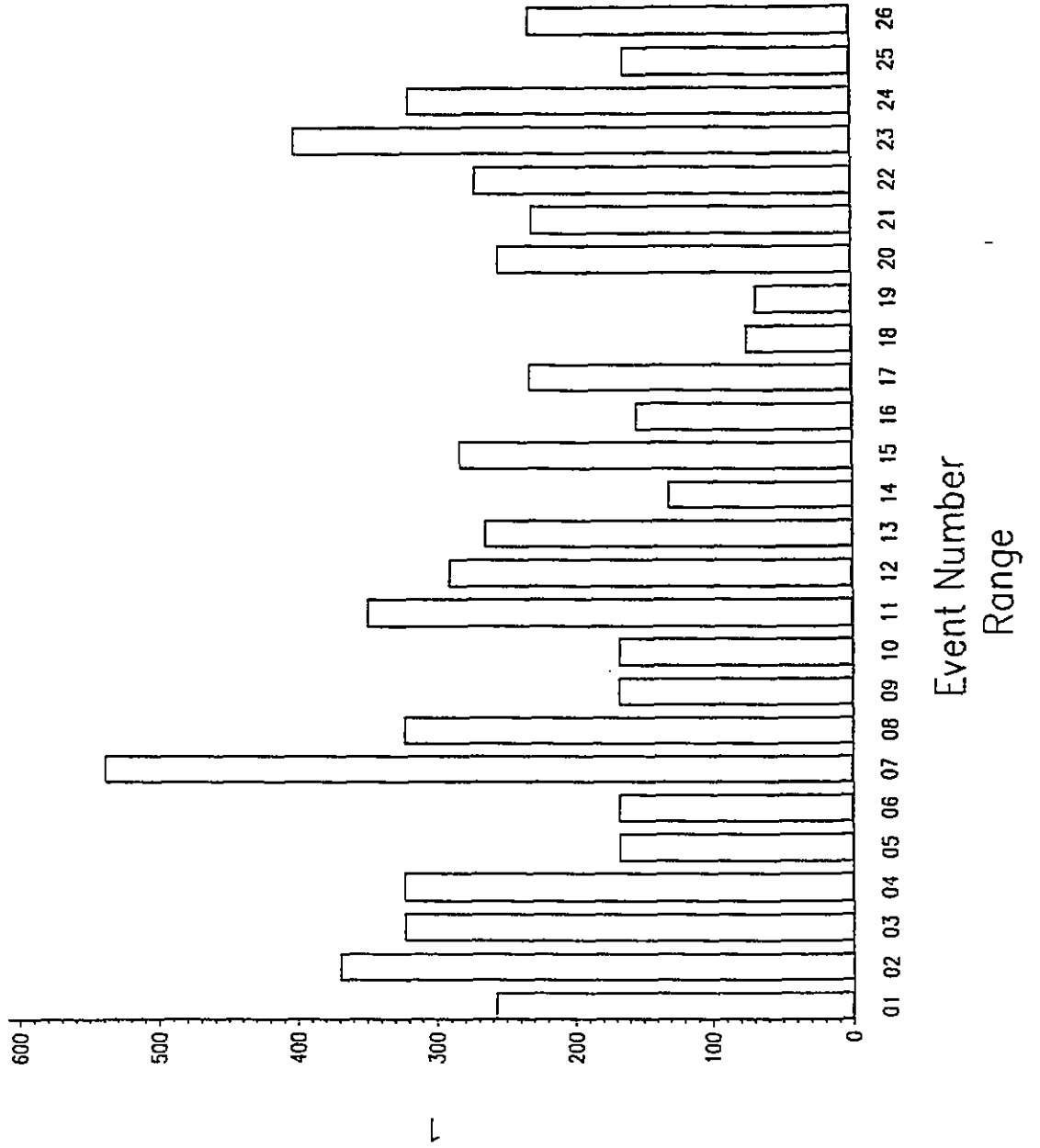

# Summary Statistics for Mean

DEMO PROJECT  
DEMO-01 BUONO 123456  
Flight Number 10A on 13MAY90

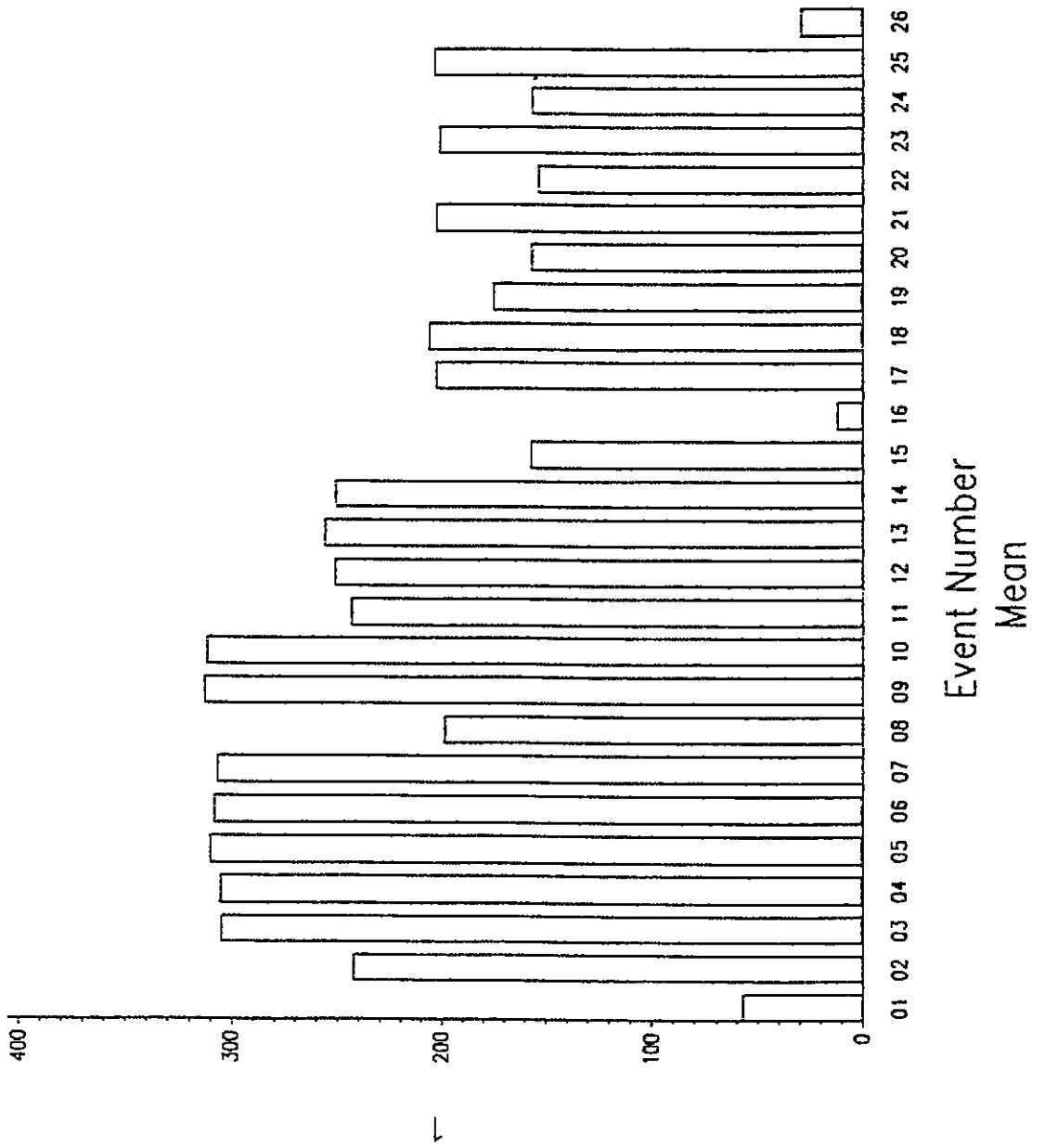

# Summary Statistics for STD

DEMO PROJECT  
DEMO-01 BuNo 123456  
Flight Number 10A on 13MAY90

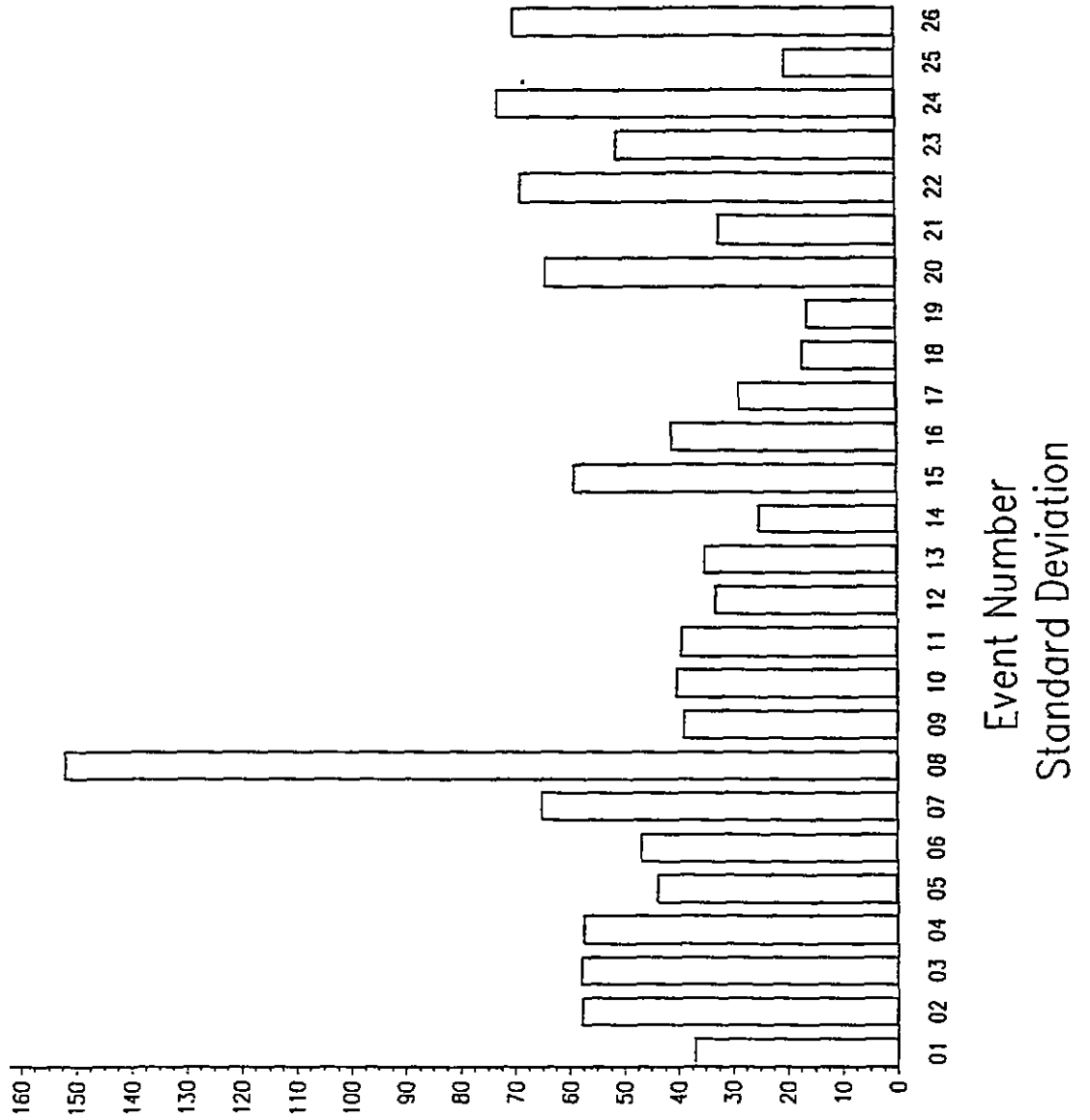

# DATA ANALYSIS NETWORK

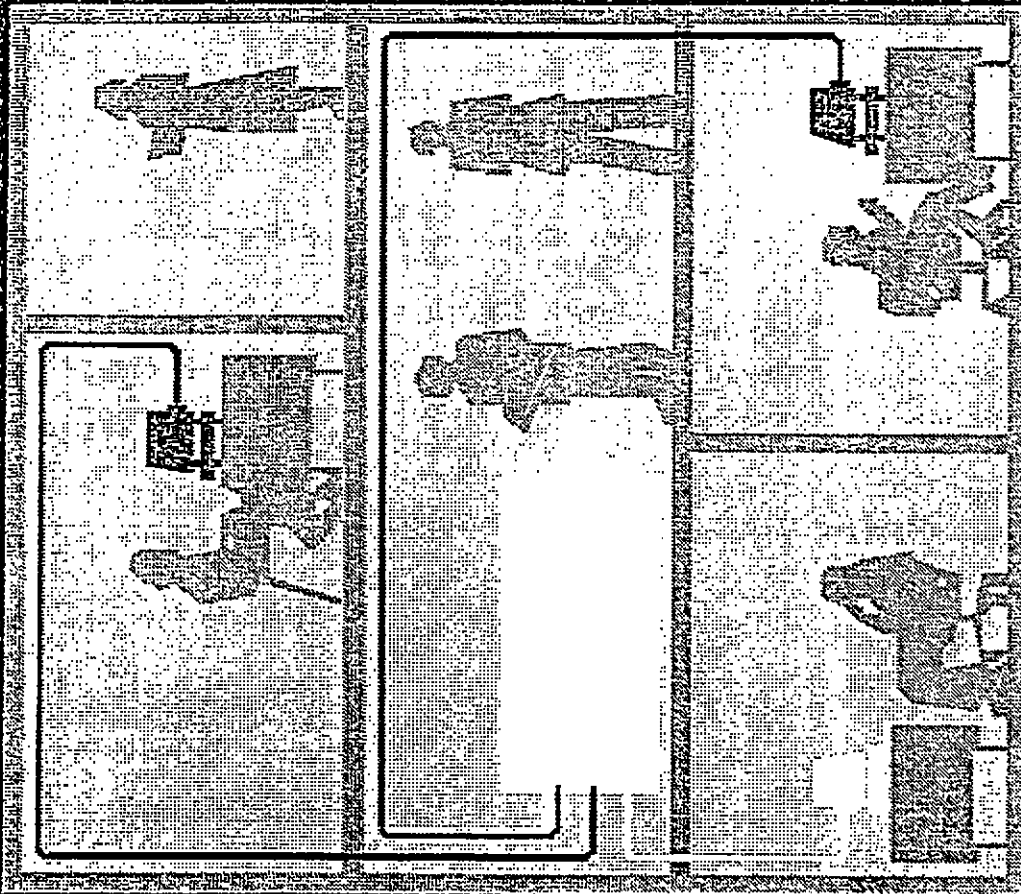

DATA REDUCTION  
AND  
COMPUTER GROUP

TYNDALL AIR FORCE BASE  
18 AUG 1993

SOFTWARE PROJECT SECTION  
412 TW/TSRC



# DATA ANALYSIS USER BENEFITS

- ⇒ Network connection +  
Terminal +  
Local printer =
  - ⇒ Access to all platforms,  
data, and analysis tools
- ⇒ Local hardcopy (text & graphics)

# DATA ANALYSIS USER BENEFITS

⇒ Network connection +  
Terminal +  
Local printer =

⇒ Maximize multiple workstation access  
and utility + minimize CTF expense,  
maintenance, and configuration control

# DATA ANALYSIS NETWORK

## FUNCTIONALITY

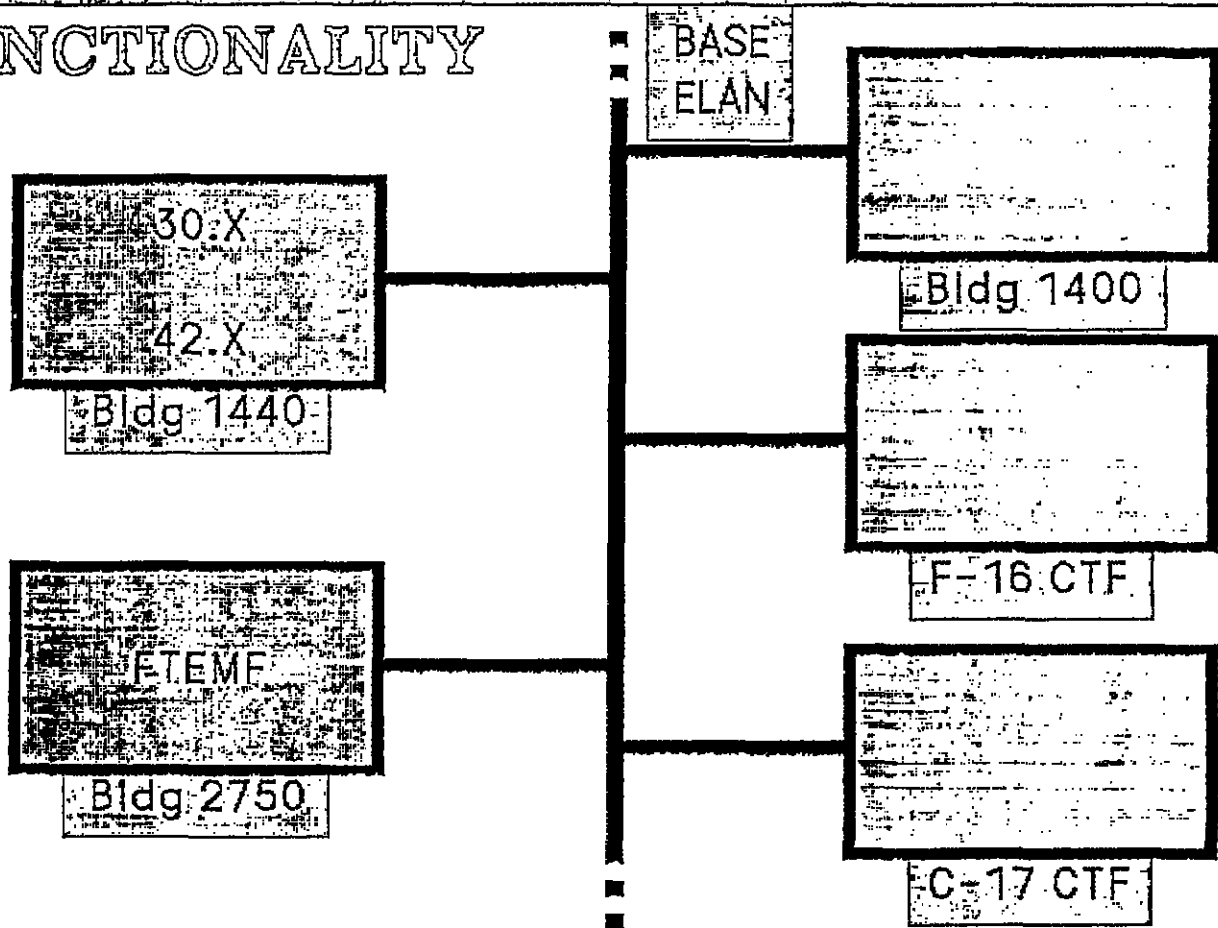

# DATA ANALYSIS NETWORK

## Bldg. 1440 Network - CYBER Branch

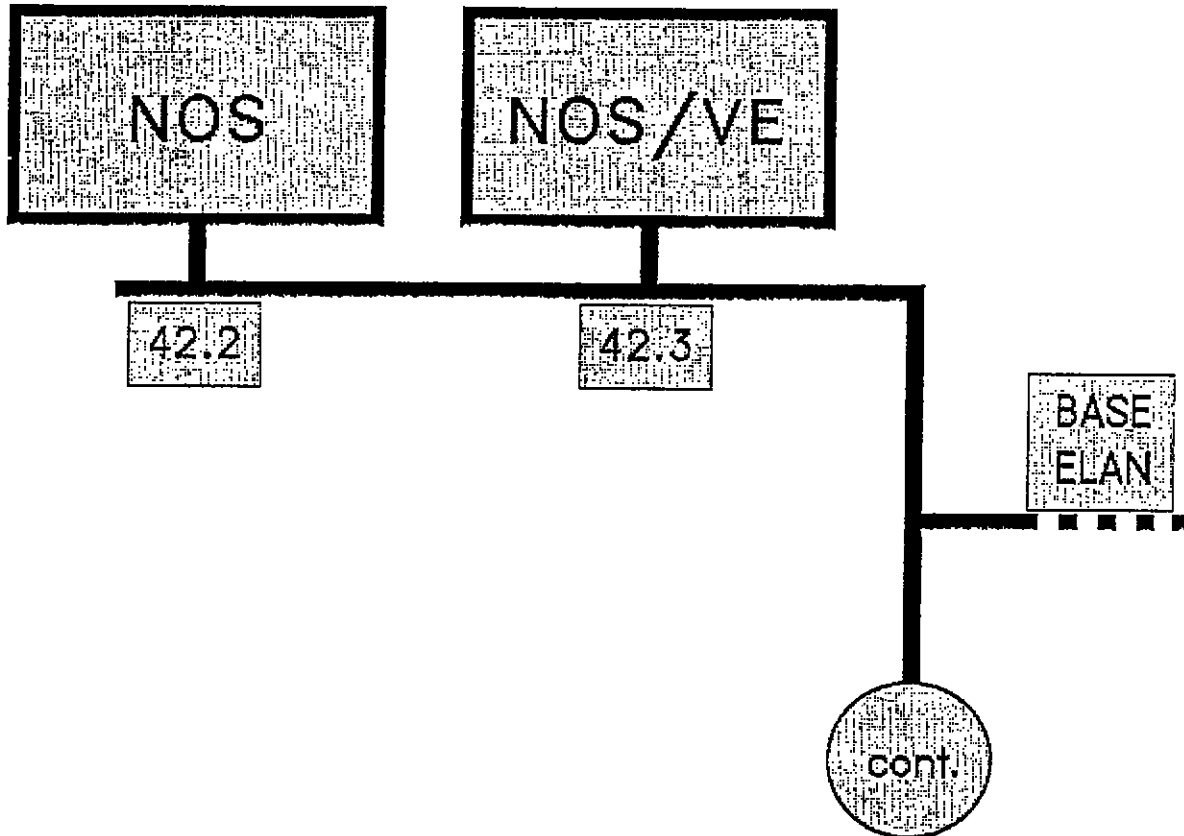

# POST-FLIGHT NETWORK DEVELOPMENT

## Bldg. 1440 Network - Other Platforms

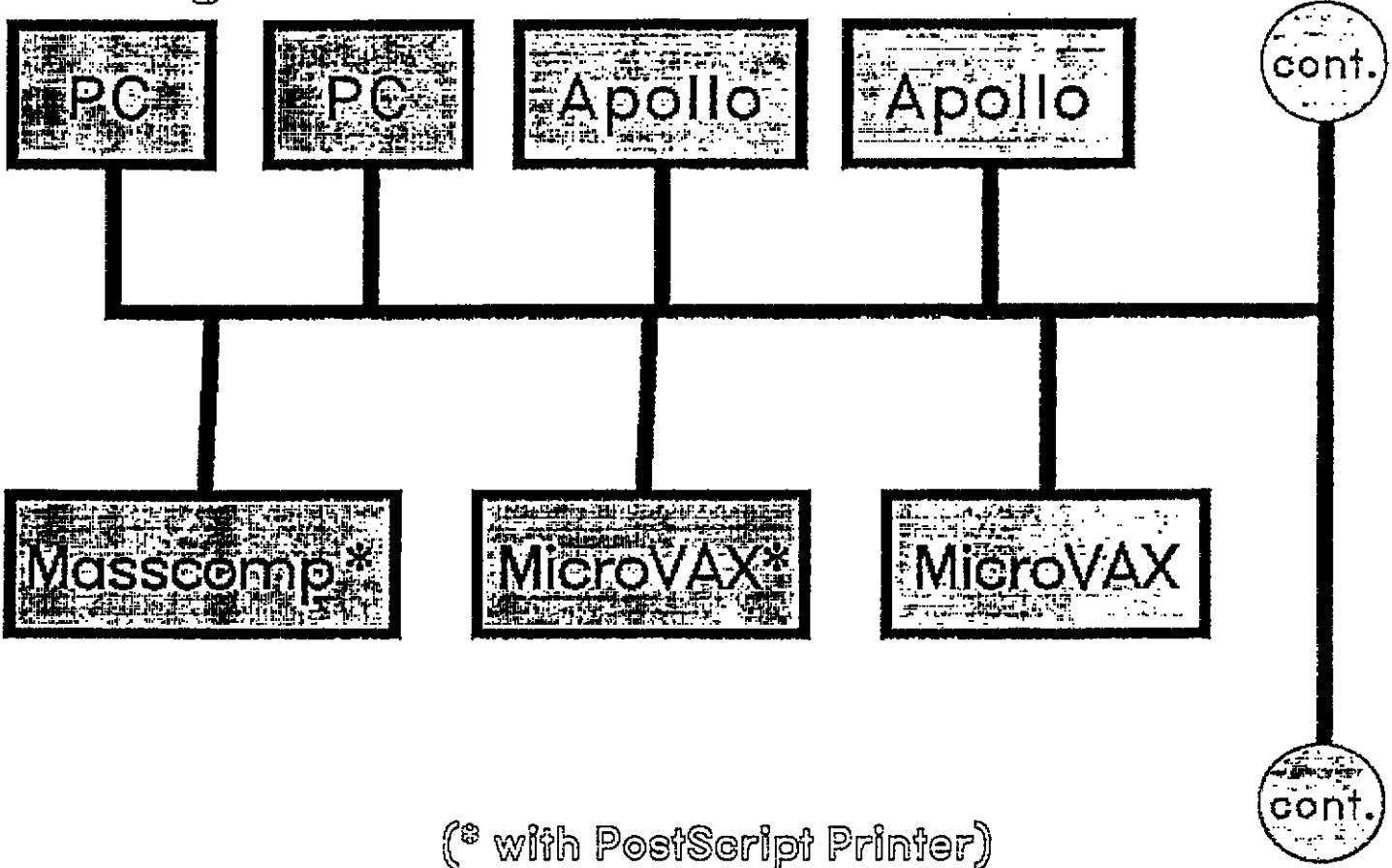

(\* with PostScript Printer)

# DATA ANALYSIS NETWORK

---

## Bldg. 1440 Network

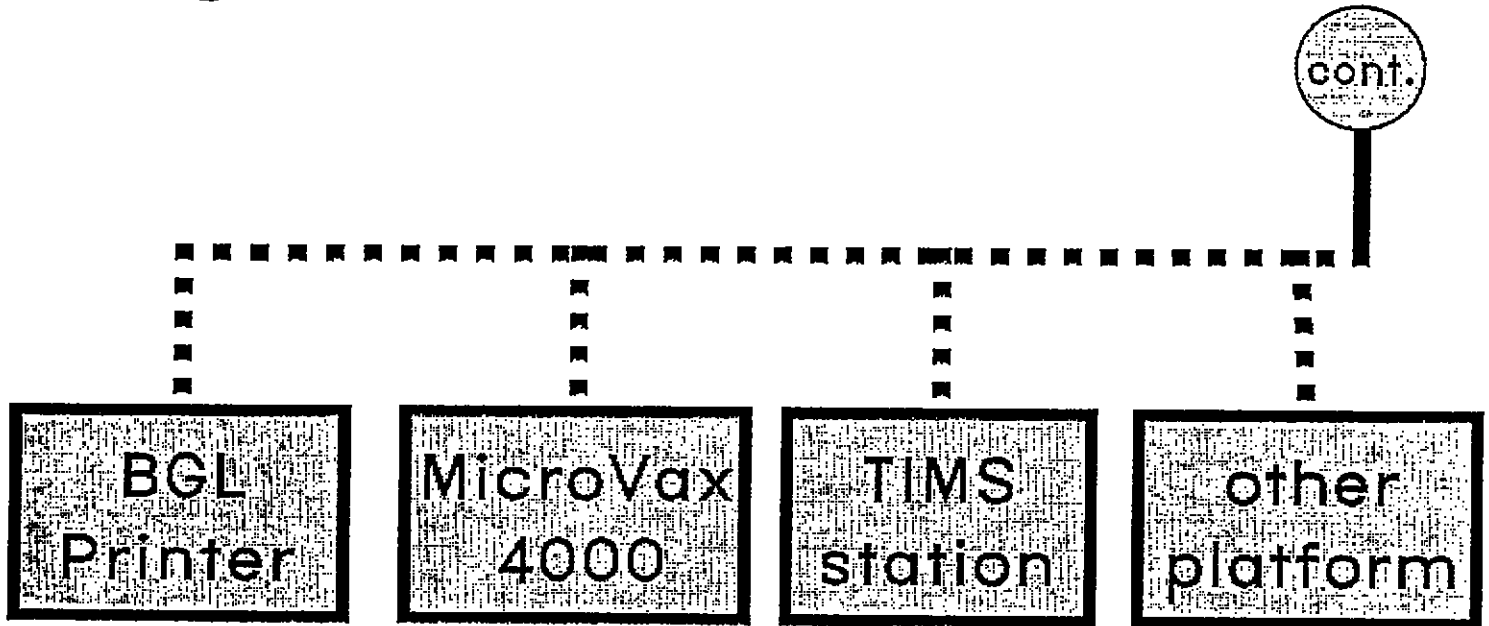

# DATA ANALYSIS NETWORK

---

## CURRENT CAPABILITY

➔ Post-flight data accessible to all platforms

➔ Analysis available:

UFTAS (CYBER)

ISDMS (CYBER)

Dataviews (MicroVax)

TEX (PC)

# DATA ANALYSIS NETWORK

---

## RCP SERVICES

- o Data Analysis Plans
- o Consult on Math, Comp. Sci.
- o Configure/Develop Analysis S/W
- o User Training
- o Systems Administration
- o Configuration Control
- o Evaluate S/W Packages  
for future network expansion



# DATA ANALYSIS CONCLUSION

Users access resources through network:

➔ Analysis

➔ Visualization

➔ Modeling

➔ Publishing

and

➔ Training

# DANET Hardware

18 Aug 93

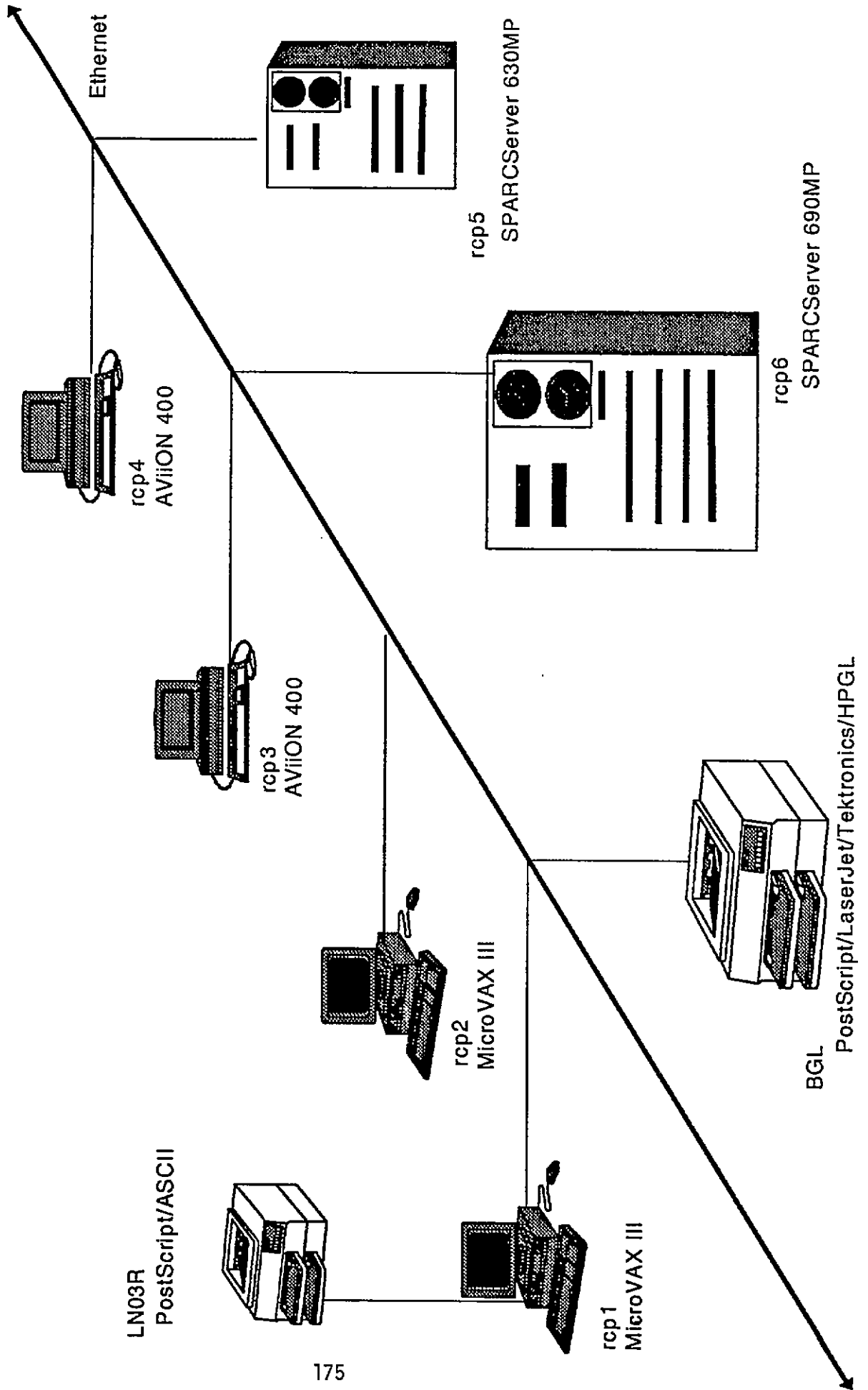

# DANET Software

18 Aug 93

- RCP & RCP2: Ultrix 4.2
  - X11, C & FORTRAN, DataViews, PV~WAVE
- RCP3 & RCP4: DG/UX 5.4
  - X11, MOTIF GUI, C & gnu C, TIMS, ASQL, TEX
- RCP5: Solaris 1.1
  - X11, OpenLook GUI, C++ & FORTRAN, WordPerfect,
  - FrameMaker, PV~WAVE, PV~WAVE Point&Click
- RCP6: Solaris 1.1
  - X11, OpenLook GUI, C++ & FORTRAN, Ada Development Environment,
  - System Software AnswerBook, InterLeaf Publishing,
  - PV~WAVE, PV~WAVE Point&Click, JobAcct Accounting system.

# Levels of Software

- Seamless system:  
Multifunctional system with a *single* user interface
- Seamless subsystems:  
Several seamless systems accessible through a *common* interface
- Multiple systems:  
Unique interfaces accessible via networks
- Isolated systems with no common interface

# Heterogeneous Network

- Adapts with growth
- Manages islands of automation
- Enables resource sharing
- Optimizes current & future computing resources

# Distributed Processing

in a heterogeneous network

- Processing activities occur in more than one system or computer -- can be simultaneous!
- Systems can be geographically located anywhere
- End users are unaware of physical distribution
- Authentication (user validation, device access, file access, print services...) are handled remotely

# Characteristics of DANET

- Separation
  - Parallel execution in multiple systems
- Transparency
  - Projection of single integrated processing facility
  - Conceals the separation from end users and application programs

# Network Services

## Tools & Utilities

- All systems linked by TCP/IP  
Reliable, user-transparent protocols
- Remote logins: TELNET
- Remote file transfer: FTP
- Distributed file systems: NFS  
Transparent access to remote filesystems
- Remote applications with interprocess  
communication: XDR & RPC



# Integration of Multivendor Systems & Desktops

- o CDC Cyber mainframe (NOS, NOS/VE)
  - Large computing and storage capacity
  - Digital tape to disk files, fundamental analyses.
  - UFTAS, MMLE, PEST, ISDMS, IBEDIT, ...
  
- o SUN SPARCServer 690MP (SUN OS, SOLARIS)
  - Graphical analysis of 2nd generation data.
  - Network services, mail & printing services.
  - Simultaneous multihost access by X-Windows
  - PV~WAVE, In-house scientific applications, ...
  
- o Data General and Sun workstations (UNIX variations)
  - Graphics processing, publishing, report generation.
  - Network services, mail & printing services.
  - Simultaneous multihost access by X-Windows
  - FRAMEMAKER, INTERLEAF, ...
  
- o Personal desktop computers (386/486, DOS, UNIX)
  - Desktop publishing, report writing.
  - Personal, classified data storage & transfer.
  - WordPerfect, Microsoft Word, Corel Draw, ...