



**AIRBORNE NETWORK CAMERA STANDARD**

**ABERDEEN TEST CENTER  
DUGWAY PROVING GROUND  
REAGAN TEST SITE  
WHITE SANDS MISSILE RANGE  
YUMA PROVING GROUND**

**NAVAL AIR WARFARE CENTER AIRCRAFT DIVISION  
NAVAL AIR WARFARE CENTER WEAPONS DIVISION  
NAVAL UNDERSEA WARFARE CENTER DIVISION, KEYPORT  
NAVAL UNDERSEA WARFARE CENTER DIVISION, NEWPORT  
PACIFIC MISSILE RANGE FACILITY**

**30TH SPACE WING  
45TH SPACE WING  
96TH TEST WING  
412TH TEST WING  
ARNOLD ENGINEERING DEVELOPMENT COMPLEX**

**NATIONAL AERONAUTICS AND SPACE ADMINISTRATION**

**DISTRIBUTION A: APPROVED FOR PUBLIC RELEASE  
DISTRIBUTION IS UNLIMITED.**

This page intentionally left blank.

**Document 466-15**

**Airborne Network Camera Standard**

**June 2015**

**Prepared by**

**Optical Systems Group**

**Range Commanders Council**

**Published by**

**Secretariat**

**Range Commanders Council  
US Army White Sands Missile Range  
New Mexico 88002-5110**

This page intentionally left blank.

## Table of Contents

<b>Preface</b> .....	<b>vii</b>
<b>Acronyms</b> .....	<b>ix</b>
<b>Chapter 1. Introduction</b> .....	<b>1-1</b>
1.1 Scope.....	1-1
1.2 Purpose.....	1-1
<b>Chapter 2. General Overview</b> .....	<b>2-1</b>
2.1 Interface Levels and Requirements Matrix.....	2-3
2.2 System Architecture Overview .....	2-4
<b>Chapter 3. System Devices and Operational Environments</b> .....	<b>3-1</b>
3.1 Useful Terms.....	3-2
3.2 Types of On-Board Cameras .....	3-2
3.2.1 Type I Camera.....	3-2
3.2.2 Type II Camera .....	3-2
3.2.3 Type III Camera.....	3-2
3.2.4 Type IV Camera.....	3-2
<b>Chapter 4. Operational Requirements</b> .....	<b>4-1</b>
4.1 Bootstrap Registers .....	4-1
4.2 Device Discovery.....	4-2
4.2.1 Static IP.....	4-3
4.2.2 Device Discovery Message.....	4-4
4.2.3 Device Discovery IP Address .....	4-4
<b>Chapter 5. GenICam Features</b> .....	<b>5-1</b>
5.1 Device Control.....	5-1
5.1.1 Device Control Parameters .....	5-1
5.1.2 Device Control Custom Features .....	5-2
5.2 Image Format Control.....	5-3
5.3 Acquisition Control.....	5-5
5.3.1 Continuous .....	5-7
5.3.2 Single Frame .....	5-7
5.3.3 Multi-Frame .....	5-7
5.3.4 Acquisition Control Features .....	5-8
5.3.5 Acquisition Control Custom Features.....	5-9
5.4 Exposure Control .....	5-13
5.4.1 Exposure Control Features.....	5-13

5.4.2	Exposure Control Custom Features .....	5-14
5.5	Buffer Control.....	5-15
5.5.1	Buffer Control Features .....	5-15
5.5.2	Buffer Control Custom Features.....	5-16
5.6	Local Media Control.....	5-23
5.6.1	Local Media Control Features .....	5-24
5.6.2	Local Media Custom Features .....	5-24
5.7	Digital I/O Control.....	5-28
5.8	Event Control.....	5-28
5.8.1	Event Control Features .....	5-29
5.8.2	Event Control Custom Features .....	5-33
5.9	Analog Control.....	5-43
5.9.1	Analog Control Features .....	5-43
5.9.2	Analog Custom Features.....	5-44
5.10	Transport Layer Control .....	5-45
5.11	User Set Control.....	5-47
5.12	Time Source Control.....	5-48
5.12.1	Time Source Control Features .....	5-48
5.12.2	Time Source Control Custom Features.....	5-48
5.13	File Access .....	5-50
5.13.1	File Access Features .....	5-50
5.13.2	File Access Control Custom Features.....	5-51
<b>Chapter 6.</b>	<b>GEV Control Protocol .....</b>	<b>6-1</b>
6.1	Control Channel Command and Acknowledge Values .....	6-1
6.2	Message Channel .....	6-2
6.2.1	Message Channel Bootstrap Registers.....	6-3
<b>Chapter 7.</b>	<b>Streaming Protocol .....</b>	<b>7-1</b>
7.1	Continuous Live Streaming .....	7-1
7.2	Continuous Memory Acquisition.....	7-1
7.3	Multi-Frame Acquisition .....	7-1
7.4	Acquisition Data Storage .....	7-1
7.4.1	Timing Source and Synchronization.....	7-2
7.4.2	Relative Time Counter.....	7-3
7.4.3	Acquisition Data Storage - Setup Record Packets .....	7-3
7.4.4	Acquisition Data Storage - Time Packets .....	7-3
7.4.5	Acquisition Data Storage - Index/Event Packets .....	7-3
7.4.6	Acquisition Data Storage - Dynamic Image Packets.....	7-4

<b>Chapter 8. User Test Cases .....</b>	<b>8-1</b>
8.1 Live Preview/Local Storage/Multiple Buffers/Buffer Automation .....	8-1
8.2 Live Preview/Buffer Recording/No Local Storage.....	8-3
8.3 Live Preview/Local Storage Recording .....	8-6
<b>Appendix A. Definitions .....</b>	<b>A-1</b>
<b>Appendix B. References .....</b>	<b>B-1</b>

### List of Figures

Figure 1. Airborne Network Camera Standard Network .....	vii
Figure 2. Requirement Categories.....	2-2
Figure 3. Functional Diagram .....	3-1
Figure 4. Device Discovery Process.....	4-3
Figure 5. Image Format Control.....	5-4
Figure 6. Acquisition Control Process .....	5-6
Figure 7. Trigger Capture Point .....	5-6
Figure 8. Data Transfer Path .....	5-7
Figure 9. Buffered Acquisition and Streaming .....	5-15
Figure 10. Event Message .....	5-28
Figure 11. Acquisition Data Storage Directory/File .....	7-2

### List of Tables

Table 1. Requirement Interface Levels .....	2-3
Table 2. Optical Systems Group-Standard-Compliant Registers.....	4-1
Table 3. Message Numerical Values.....	6-1

This page intentionally left blank.



## Preface

The deployment of network-based airborne instrumentation systems is leading to cost-efficient replacement for legacy equipment. One application of airborne data acquisition that has to this point been developed without the focus of standardization for interoperable command and control, storage, and data streaming has been the airborne network camera systems used throughout all Department of Defense (DoD) Major Range and Test Facility Bases (MRTFBs).

This Range Commanders Council (RCC) Optical Systems Group (OSG) standard has been developed to facilitate compliancy and interoperability between airborne cameras and components. This standard defines queries, action commands, recording format, and data streaming requirements for cameras utilized in airborne applications by both industry and DoD ranges. Not all requirements may be applicable to all types of camera implementations. The intent of this standard is primarily to cover terminology included in or consistent with the GigE Vision<sup>1</sup> (GEV) and IRIG 106-13 Chapter 10<sup>2</sup> standards for command and control over a variety of different interfaces. Functionality associated with this standard include the acquisition, processing, recording, streaming, and timing of high-speed airborne imagery. When an OSG-compliant airborne camera simultaneously supports multiple interfaces, it must comply with the interface and command precedence specified in this standard.

An OSG-compliant system may consist of a single camera or multiple cameras in a network. A camera may support a single or multiple network interfaces, as illustrated in [Figure 1](#). Strict adherence to the GEV standard and requirements of this standard is required to enable interoperability of cameras from different manufacturers. This allows a plug-and-play system environment between devices and implementations. This standard does not define control application or requirements. Although the GEV standard provides for a wide spectrum of network topologies, this standard will only focus on a topology representative of an aircraft configuration. Other topologies may be included as a separate standard of the OSG for other on-board or ground systems.

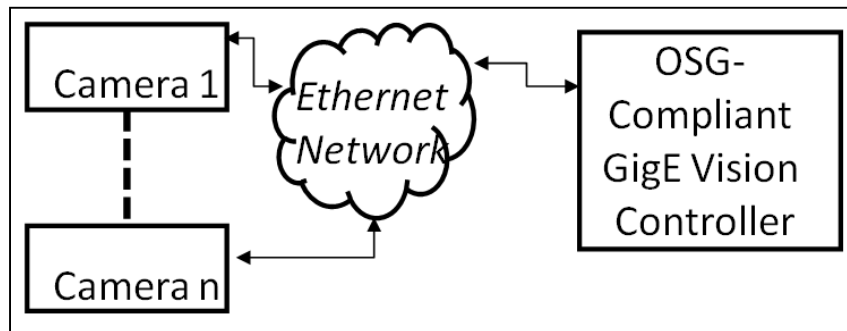

Figure 1. Airborne Network Camera Standard Network

<sup>1</sup> Automated Imaging Association. GigE Vision Standard Specification. Version 2.0. November 2011. May be superseded by update. Available at [http://www.visiononline.org/form.cfm?form\\_id=701](http://www.visiononline.org/form.cfm?form_id=701).

<sup>2</sup> Range Commanders Council. Telemetry Standards. Chapter 10, Digital Recording Standard. IRIG 106-13. June 2013. May be superseded by update. Available at [http://www.wsmr.army.mil/RCCsite/Documents/106%20Previous%20Versions/106-13\\_Telemetry\\_Standards/chapter%2010.pdf](http://www.wsmr.army.mil/RCCsite/Documents/106%20Previous%20Versions/106-13_Telemetry_Standards/chapter%2010.pdf).

The OSG prepared this standard, which provides the ranges with a standards-based solution for implementation of network-based airborne cameras from multiple vendors and an improvement in cost competitiveness.

Any range that requires cameras will benefit from this standard. The purpose of this OSG effort is the identification of the needs of the MRTFB community for standardized data acquisition and recording from airborne cameras. This document presents a common standard for use by industry to ensure interoperability and competition for a more cost-effective solution for the ranges. Use of this document will also eliminate the need to rely on a single source for critical equipment in the support of range missions within the MRTFBs.

For the development of this standard, the RCC gives special recognition to Mr. Alfredo Berard, 96 TW, 96 RANSS/RNRE, Eglin AFB, Florida, and the OSG Digital Imager Working Group chair, Mr. Nestor Portilla.

For their exceptional technical support during the developmental effort, the RCC is also indebted to the following individuals:

Mark Buckley, Telspan Data  
Stephen Cszasz, Parks Photographic Laboratory  
Reto Huber, AOS Technologies  
Rick Southerland, IDT Inc  
Peter Chen, Ampex Corp.  
Eric Lamphear, Telspan Data  
Boris Nalibotski, A&B Software LLC  
Dr. Joe Stufflebeam, TRAX WSMR  
Eric Buckthal, 96 TW  
Craig Bidstrup, 96 TW

For general information about this document or the OSG, you may contact the following.

Secretariat, Range Commanders Council  
ATTN: TEDT-WS-RCC  
1510 Headquarters Avenue  
White Sands Missile Range, New Mexico 88002-5110  
Telephone: (575) 678-1107, DSN 258-1107  
E-mail [usarmy.wsmr.atec.list.rcc@mail.mil](mailto:usarmy.wsmr.atec.list.rcc@mail.mil)

## Acronyms

μs	microseconds
ANCS	Airborne Network Camera Standard
DHCP	Dynamic Host Configuration Protocol
DoD	Department of Defense
GenICam	Generic Interface for Cameras
GEV	GigE Vision
GVCP	GigE Vision Control Protocol
GVSP	GigE Vision Streaming Protocol
IAW	in accordance with
IPH	intra-packet header
MRTFB	Major Range and Test Facility Base
OSG	Optical Systems Group
RAM	random-access memory
RCC	Range Commanders Council
ROI	region of interest
RTC	relative time counter
TCP	Transmission Control Protocol
UDP	Universal Datagram Protocol
XML	extensible markup language

This page intentionally left blank.

## CHAPTER 1

### **Introduction**

#### **1.1 Scope**

This standard addresses airborne on-board cameras operated in a networked architecture. The sections of this standard are devoted to camera network discovery, camera configuration, data streaming, and local data recording.

#### **1.2 Purpose**

The purpose of this document is to define the minimum standardization and parameter requirements in a manner that allows for multiple cameras from different vendors to be utilized on the same platform or across all MRTFBs. It is not the intent of this standard to require that all ANCS-compliant cameras provide the same capability. Rather, it is to establish minimum threshold requirements that will facilitate plug-n-play systems integration and data interoperability. This standard does not define system architecture as it only defines the standard queries, action commands, recording format, and data streaming requirement for airborne separation video cameras utilized in vehicle applications. Not all requirements may be applicable to all types of ANCS implementations. The intent of this standard is primarily to cover terminology included in or consistent with the GEV standard and the IRIG 106 Chapter 10 standard document.

This page intentionally left blank.

## CHAPTER 2

### General Overview

This standard will leverage the GEV standard employing a proven set of Open Systems Interconnection layer protocols. The GEV standard was ratified in May 2006 by members of the Automated Imaging Association. The GEV standard provides an open framework for transferring images and control signals between cameras and a control application over Gigabit Ethernet connections and now 10-Gigabit Ethernet in Version 2.0. The GEV standard has been adopted by dozens of leading hardware and software companies that develop and sell equipment, high-performance video, and imagery applications. The value of the GEV standard in high-performance, real-time video and imagery applications has been proven in thousands of deployments in the military, aerospace, medical, and manufacturing sectors.

The GEV standard is based on Ethernet protocol; however, it is customized for machine vision applications with a goal to offer more reliable image data transmission and a uniform camera control standard. The GEV standard uses Universal Datagram Protocol (UDP) to handle transport at Layer 4 rather than Transmission Control Protocol (TCP). The UDP was selected for its simplicity, low overhead, and multicast support. A benefit to an on-board application are low-latency networked video. The GEV standard includes an optional mechanism that allows video sources to resend undelivered data to video receivers. This mechanism, together with other areas of the standard, allows performance-oriented implementations of the GEV standard to guarantee video transport and achieve low and predictable latency, even during a resend.

The GEV standard consists of four major parts plus it incorporates the Generic Interface for Cameras (GenICam) standard<sup>3</sup> to describe the features supported by the camera. Critical to interoperability between GEV cameras and GEV application software, any OSG GEV device MUST provide an extensible markup language (XML) device description file compliant to the syntax of the GenICam as mandated by this standard. This standard will define unique GenICam features of cameras that are required for MRTFB interoperability.

Interface requirements are divided into three categories as follows.

- a. **Mandatory**: This category contains the minimum set of requirements for interoperability. In this standard, (M) means mandatory.
- b. **Optional**: This category contains requirements that may or may not be implemented and may be shown as references. In this standard, (O) means optional.
- c. **Conditional**: A conditional requirement is mandatory if an optional requirement is being met. In this standard, (C) means conditional.

This standard will provide clear definition of mandatory, optional, and conditional requirements. Features that are unique to this standard will be denoted in ***bold italic***. Features that are standard to the GEV and GenICam standards will be provided for each functional category. This standard requires at a minimum for a camera to be compliant with GEV 1.2 and

---

<sup>3</sup> European Machine Vision Association. Generic Interface for Cameras. Version 2.0. 11 June 2009. May be superseded by update. Available at [http://www.emva.org/cms/upload/Standards/GenICam\\_Downloads/GenICam\\_Standard\\_v2\\_0.pdf](http://www.emva.org/cms/upload/Standards/GenICam_Downloads/GenICam_Standard_v2_0.pdf).

GenICam 2.0 specifications. Specific categories provided by this standard are displayed in [Figure 2](#).

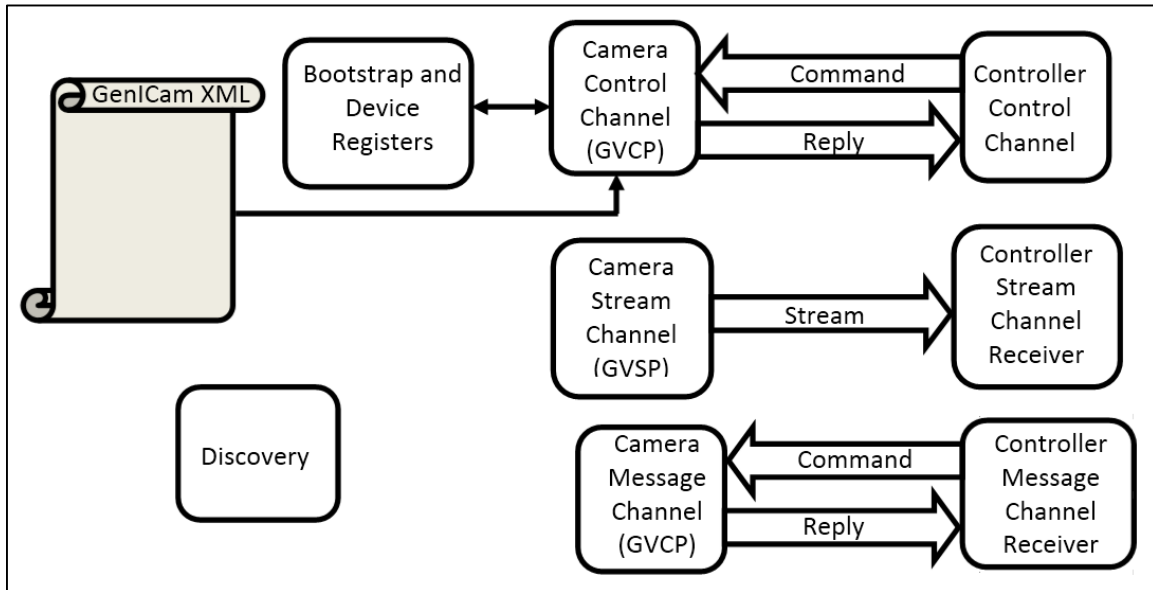

Figure 2. Requirement Categories

**Device Discovery:** Covers the sequence of events for a controllable device to get a connection through its network interface and obtain a valid IP addressing standard IP protocols and for a control application to enumerate devices on the network.

This standard provides specific discovery requirements from the GEV standard. Critical to on-board applications are the ability of the system to automatically recover from camera cycles and for cameras to be discovered as they may be replaced during pre-flight operations. Section [4.2](#) outlines the mandated requirements for discovery.

**GigE Vision Control Protocol (GVCP):** An application layer protocol replying on the UDP transport layer protocol. It allows an application to configure a device (typically a camera) and instantiate stream channels (GVSP transmitters or receivers, when applicable) on the device and for the device to notify an application when specific events occur. Specific GVCP requirements applicable to an ANCS-compliant camera are provided in [Chapter 6](#).

**GigE Vision Streaming Protocol (GVSP):** The GVSP is an application layer protocol. It allows a GVSP receiver to receive image data, image information, or other information from a GVSP transmitter. The GVSP packets always travel from a GVSP transmitter to a receiver. Specific GVSP requirements applicable to an ANCS-compliant camera are provided in [Chapter 7](#).

**Bootstrap Registers:** Provides configuration of a device via read/write registers. These registers are common to GEV devices and are located at fixed addresses. This standard utilizes contents of bootstrap registers for identification and tracking of data from the devices. For example, a bootstrap register may indicate location of an ANCS-compliant camera. The image data stream or acquisition storage file is tagged with the location name, providing identification and position



of an on-board camera. Specific bootstrap register requirements applicable to an ANCS-compliant camera are provided in Section [4.1](#).

**GenICam Features:** All GEV-compliant devices must provide a GenICam XML file to describe the features supported by the device. To allow interoperability of on-board cameras within the MRTFB, this standard outlines specific and mandated features within the GenICam XML file. The XML device description file provides the mapping between a device feature and the device register supporting it. There are specific and mandatory features that must be provided from a device to allow for compliance with this standard. Tables will be provided where applicable, defining OSG-mandatory features. Additional features may be added to the XML file as required; however, additional features shall not duplicate functionality of mandated features.

## 2.1 Interface Levels and Requirements Matrix

This standard establishes the following for an ANCS-compliant camera utilized by MRTFB organizations: a common interface; command and control; and acquisition. This standard does not imply specific hardware architecture or components such as the coupling of data acquisition, multiplexing, and media storage. Rather, interface levels and their requirements are put forth to achieve standardization and interoperability of system devices and data. The requirements interface levels provided by this standard are outlined in [Table 1](#).

<b>Table 1. Requirement Interface Levels</b>		
<b>Interface Level</b>	<b>Requirement</b>	<b>Applicable Section</b>
Bootstrap Registers	(M)	<a href="#">4.1</a>
Device Discovery	(M)	<a href="#">4.2</a>
Device Control	(M)	<a href="#">5.1</a>
Image Format Control	(M)	<a href="#">5.2</a>
Acquisition Control	(M)	<a href="#">5.3</a>
Exposure Control	(M)	<a href="#">5.4</a>
Buffer Control	(C)	<a href="#">5.5</a>
Local Media Control	(C)	<a href="#">5.6</a>
Digital I/O Control	(M)	<a href="#">5.7</a>
Event Control	(M)	<a href="#">5.8</a>
Analog Control	(O)	<a href="#">5.9</a>
Transport Layer Control	(M)	<a href="#">5.10</a>
User Set Control	(M)	<a href="#">5.11</a>
Time Source Control	(M)	<a href="#">5.12</a>
File Access	(M)	<a href="#">5.13</a>
GigE Vision Control Protocol	(M)	<a href="#">Chapter 6</a>
Control Channel Command and Acknowledge Values	(M)	<a href="#">6.1</a>
Message Channel	(M)	<a href="#">6.2</a>
GigE Vision Streaming Protocol	(M)	<a href="#">Chapter 7</a>
Live Streaming	(M)	<a href="#">7.1</a>
Multi-Frame Acquisition	(M)	<a href="#">7.3</a>
Acquisition Data Storage	(C)	<a href="#">7.4</a>

## **2.2 System Architecture Overview**

An ANCS-compliant camera may operate in stand-alone mode or as an integral component of a network. A network may have a single or multiple cameras. Strict adherence to the GEV standard and requirements of this standard is required to facilitate interoperability of cameras from different manufacturers. On a vehicle platform, it is critical of the system to be automated with minimum operator assistance. As video and imaging technology advances, the types of cameras and their interfaces continually evolve to meet the needs of a host of applications. In its most basic form, the requirement for an on-board camera is to trigger, capture the data of interest, and store the captured data to nonvolatile storage. In an ANCS system there is a requirement to enforce a more rigid or known network topology of devices than perhaps a ground system might employ. In a ground-based system a network device can be removed and replaced rather easily in a “hot-swap” mode but in an on-board environment this is not the case. This chapter does not define the control application, network architecture, and/or limitations. Although the GEV standard provides for a wide spectrum of network topologies, this standard will only focus on requirements of an OSG-compliant camera.

## CHAPTER 3

### System Devices and Operational Environments

It is recognized that different ANCS-compliant camera capabilities are required for MRTFB application environments. This section defines different camera capabilities within this standard. The basic building blocks of a compliant OSG ANCS-compliant camera are listed in [Figure 3](#). [Table 1](#) provides links to the applicable sections for each building block. This standard can also be implemented for compliance and interoperability on MRTFB on-board devices (network switches, network controllers, host applications) such as GEV primary or secondary applications that are not specifically defined herein.

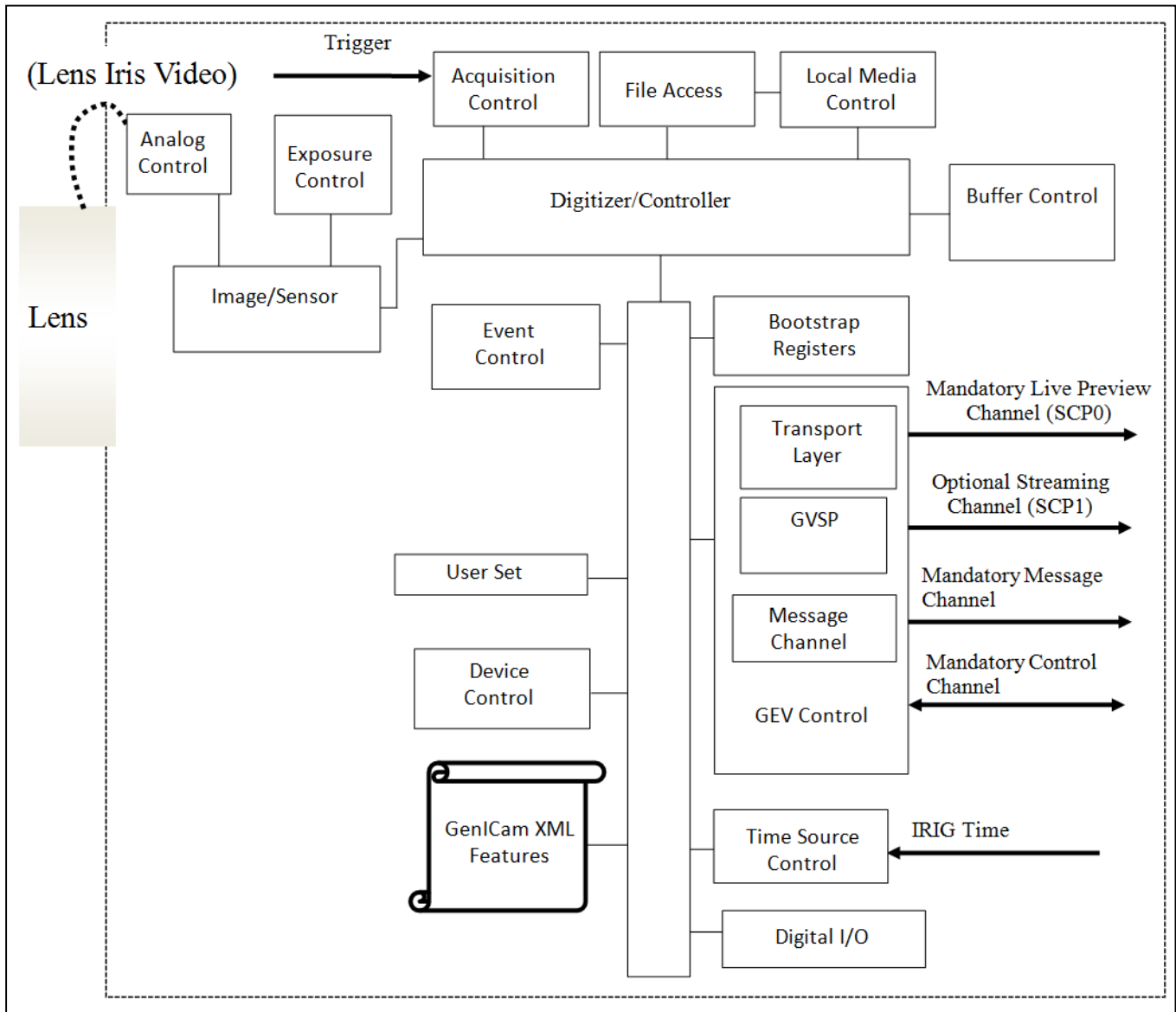

Figure 3. Functional Diagram

### 3.1 Useful Terms

In defining specific camera architectures and their operational environments the following terms and section definitions are presented.

Live Streaming: Live images are continuously streamed in a preview mode. Live streaming shall be in accordance with (IAW) the GEV standard and requirements of this standard utilizing SCP0.

Sensor Buffer Storage: Image data that is captured by the sensor is stored in a single or multiple buffers in RAM. The data can be transferred to a destination on the network IAW the GEV standard and utilizing SCP1 defined in this standard.

Acquisition Data Storage: Buffer data is stored to non-volatile memory IAW the IRIG 106 Chapter 10 standard and Section 7.4. Stored data will be accessed IAW the IRIG 106 Chapter 10 standard from local or removable memory.

Stored Data Transfer: Data that has been acquired into a buffer or multiple buffers may be optionally transferred utilizing SCP1.

### 3.2 Types of On-Board Cameras

There are currently four types of on-board cameras covered by this standard, as listed below. The rate of live streaming for each camera can be programmable.

 <p><b>NOTE</b></p>	<p>Cameras may operate in stand-alone mode without use of a controller configured from GenICam features.</p>
-------------------------------------------------------------------------------------------------------	--------------------------------------------------------------------------------------------------------------

#### 3.2.1 Type I Camera

This camera provides only live streaming of images. The Ethernet interface to the camera shall comply with the GEV standard and requirements of this standard.

#### 3.2.2 Type II Camera

In addition to live streaming utilizing SCP0, this camera includes storage to multiple buffers. This type of camera provides multiple sequential acquisitions to multiple memory buffers. Transfer of data from the buffers shall be accomplished utilizing SCP1 IAW the GEV standard and this standard.

#### 3.2.3 Type III Camera

In addition to the features of a Type II camera, this camera provides acquisition data storage. The Ethernet interface to the camera shall be in compliance with the GEV standard and requirements of this standard.

#### 3.2.4 Type IV Camera

This camera adds stored data transfer to the features of a Type III camera. The camera has the capability for live streaming of image data, acquisition data storage IAW Section 7.4, and stored data transfer utilizing SCP1. The Ethernet interface to the camera shall be in compliance with the GEV standard and requirements of this standard.

<p><b>NOTE</b></p> 	<p>Cameras that support sensor buffer storage (TYPE II and TYPE IV) have their image format control features indexed by the BufferSelector feature. The BufferSelector feature allows for buffers to have their own region of interest (ROI) or image format and can be utilized to set format for live stream data to be different from the one that is recorded.</p>
------------------------------------------------------------------------------------------------------	------------------------------------------------------------------------------------------------------------------------------------------------------------------------------------------------------------------------------------------------------------------------------------------------------------------------------------------------------------------------

This page intentionally left blank.

## CHAPTER 4

**Operational Requirements**

The operation requirements are defined in this section for device discovery, configuration and control, live streaming, triggering, and acquisition.

**4.1 Bootstrap Registers**

The device bootstrap registers allow a GEV primary application to configure the device, create the message, and stream channels. It is not possible for a GEV primary application to instantiate a message or stream channels if it does not first have a control channel with exclusive or control access (without or with switchover enabled) to the device. All mandatory bootstrap registers shall be present on all GEV-compliant devices. Mandatory OSG-standard-compliant registers are defined in [Table 2](#).

<b>Table 2. Optical Systems Group-Standard-Compliant Registers</b>	
<b>Bootstrap</b>	<b>Description</b>
0x0000	Version
0x0004	Device Mode
0x0008	Device MAC address - High
0x000C	Device MAC address - Low
0x0010	Supported IP configuration
0x0014	Current IP configuration procedure
0x0024	Current IP address
0x0034	Current subnet mask
0x0044	Current default Gateway
0x0048	Manufacturer name
0x0068	Model name
0x0088	Device version
0x00A8	Manufacturer specific information
0x00D8	Serial number
0x00E8	User-defined name
0x0200	First choice of URL for XML device description file
0x0400	Second choice of URL for XML device description file
0x0600	Number of network interfaces
0x064C	Persistent IP address (Network interface #0)
0x065C	Persistent subnet mask (Network interface #0)
0x066C	Persistent default gateway
0x0670	Link Speed (Network interface #0)
0x0900	Number of Message channels
0x0904	Number of Stream channels
0x0908	Number of Action Signals
0x090C	Action Device Key Register

0x092C	Stream channels Capability
0x0930	Message channel Capability
0x0934	GVCP Capability
0x0938	Heartbeat timeout
0x093C	Timestamp tick frequency - High
0x0940	Timestamp tick frequency - Low
0x0944	Timestamp control
0x0948	Timestamp value (latched) - High
0x094C	Timestamp value (latched) - Low
0x0954	GVCP Configuration Register
0x0958	Pending Timeout
0x095C	Control Switchover Key
0x0A00	Control Channel Privilege register
0x0B00	Message Channel Port Register (MCP)
0x0B10	Message Channel Destination Address Register (MCDA)
0x0B14	Message Channel Transmission Timeout Register (MCTT)
0x0B18	Message Channel Retry Count Register (MCRC)
0x0B1C	Message Channel Source Port Register (MCSP)
0x0D00	Stream Channel Port Registers (SCP <sub>x</sub> )
0x0D04	Stream Channel Packet Size Registers (SCPS <sub>x</sub> )
0x0D08	Stream Channel Packet Delay Registers (SCPD <sub>x</sub> )
0x0D18	Stream Channel Destination Address Registers (SCDA <sub>x</sub> )
0x0D1C	Stream Channel Source Port Registers (SCSP <sub>x</sub> )
0x0D20	Stream Channel Capability Registers (SCC <sub>x</sub> )
0x0D24	Stream Channel Configuration Registers (SCCFG <sub>x</sub> )

## 4.2 Device Discovery

Device discovery covers the sequence of events required for a device to obtain a valid IP address using standard IP protocols and for a GEV primary application to enumerate devices on the network. Since cameras can be added to the network at any time, a GEV primary application must have some way to discover new cameras. To accomplish this, GEV primary applications broadcast a discovery message over the network and each OSG-compliant on-board camera shall respond with its IP address within a minimum of five seconds.

Once device discovery is completed, a GEV primary application is ready to send control requests to a device. [Figure 4](#) outlines the device discovery process.



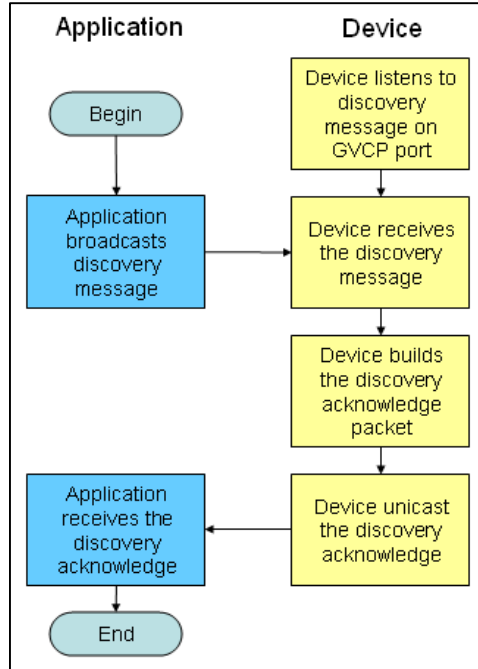



Figure 4. Device Discovery Process

Dynamic Host Configuration Protocol (DHCP) IAW the GEV standard may be utilized but an OSG-compliant ANCS requirement is to be installed on any platform without prior configuration of the IP address. A GEV primary application will manually set the IP address on the on-board camera. The IP addresses shall be predefined with the GEV primary application. The predefined address will override the existing camera address. An IP address may be lost on power cycle or reset so IAW the GEV standard the IP address shall be stored in the on-board camera non-volatile memory (bootstrap registers) to be used on power-up or reset.

In operation during system configuration, a GEV primary application will search for broadcast device discovery messages. Each camera upon power up will utilize a UDP broadcast to a destination address of 255.255.255.255. The GEV primary application will then force the IP to the device for each assigned port. It is almost a guarantee that camera power may be removed and applied during operation. Additionally, not all devices (cameras, controllers, switches) may be powered from the same power source. An instrumentation system may utilize platform power for some components and instrumentation power for others. It is critical that camera attachment and removal IAW the GEV standard be followed.

<b>Example</b> 	Source	Destination	Protocol	
	169.254.100.144	255.255.255.255	UDP	Source port: GVCP Destination port: 60496
	191.168.1.201	255.255.255.255	UDP	Source port: GVCP Destination port: 60496

#### 4.2.1 Static IP

A static IP shall be utilized in all cameras. A GEV primary application shall always set a predefined IP address.

#### 4.2.2 Device Discovery Message

If a device has a valid IP address, then it shall answer a broadcast device discovery message to the GEV primary application. This applies to any type of broadcast requests (including limited-broadcast and subnet-directed broadcasts).

In the answer message, the device shall set the source IP address, subnet mask, and default gateway equal to the IP information obtained during IP configuration. A device shall answer a unicast device discovery message using a unicast answer message to a GEV primary application.

#### 4.2.3 Device Discovery IP Address

Once a valid IP address is assigned to the device, it shall be copied into the following bootstrap registers:

- a. Current IP address (address 0x0024 for first network interface);
- b. Current subnet mask (address 0x0034 for first network interface);
- c. Current default gateway (address 0x0044 for first network interface).

## CHAPTER 5

**GenICam Features**

The roles of the GenICam Standard Features Naming Convention<sup>4</sup> are to provide a common set of features and to define a standard behavior for them. The GenICam technology allows exposing arbitrary features of a camera through a unified naming convention. Each feature can be defined in an abstract manner by its name, interface type, unit of measurement, and behavior. In this section there are *Mandatory GenICam features*, *Mandatory OSG GenICam features*, and *Conditional features* that shall be followed in order to achieve the desired levels of interoperability. In case of discrepancy, those sections describing the features in detail prevail.

**5.1 Device Control**

Device control features provide general information and control for the device. This is mainly used to identify the device during the enumeration process and to obtain information. Other information and controls pertaining to the general state of the device are also included in this category.

**5.1.1 Device Control Parameters**

Name	GenICam	OSG	Interface	Access	Unit	Description
DeviceControl	M	M	ICategory	R		Category for device information and control.
DeviceVendorName	M	M	IString	R		Name of the manufacturer of the device.
DeviceModelName	M	M	IString	R		Model of the device.
DeviceVersion	M	M	IString	R		Version of the device.
DeviceFirmwareVersion	M	M	IString	R		Version of the firmware in the device.
<b>DSPVersion</b>	M	C	IString	R		Displays the currently loaded DSP firmware version.
<b>FPGAVersion</b>	M	M	IString	R		Displays the currently loaded FPGA firmware version.
DeviceID	M	M	IString	R		Device Identifier (serial number).
DeviceUserID	M	M	IString	R/W		User-programmable Device Identifier.
MacAddress	M	M	IString	R		48-bit MAC address of the device.
DeviceReset	M	M	ICommand	W		Resets the device to its power up state.
DeviceMaxThroughput	M	M	IInteger	R	Bps	Maximum bandwidth of the data that can be streamed out of the device (bits per second).
DeviceScanType	R	M	IEnumeration	R/W		Scan type of the sensor of the device.
<b>CameraLogicVersion</b>		C	<i>IString</i>	<i>R</i>		<i>Camera logic version.</i>
<b>CameraStatus</b>		M	<i>IInteger</i>	<i>R</i>		<i>Indicates the current status of the camera.</i>

<sup>4</sup> European Machine Vision Association. Standard Features Naming Convention. Version 2.2. 17 December 2014. May be superseded by update. Available at [http://www.emva.org/cms/upload/Standards/GenICam\\_Downloads/GenICam\\_SFNC\\_2\\_2.pdf](http://www.emva.org/cms/upload/Standards/GenICam_Downloads/GenICam_SFNC_2_2.pdf).

5.1.2 Device Control Custom Features

5.1.2.1 Camera Logic Version Feature

This feature displays the currently loaded logic version. For GEV bootstrap registers, this string has a maximum length of 32 bytes (including the NULL-terminating character).

<b>Name</b>	CameraLogicVersion
<b>Level</b>	Recommended
<b>Interface</b>	IString
<b>Access</b>	Read
<b>Unit</b>	N/A
<b>Values</b>	Any NULL-terminated string

5.1.2.2 Camera Status

This feature indicates the status of the camera.

<b>Name</b>	CameraStatus																																														
<b>Level</b>	Mandatory																																														
<b>Interface</b>	IInteger																																														
<b>Access</b>	Read																																														
<b>Unit</b>	N/A																																														
<b>Values</b>	This field is a 32-bit hexadecimal value. The bit definitions are listed below.																																														
	<table border="1"> <thead> <tr> <th>Mask (Hex)</th> <th>Description</th> </tr> </thead> <tbody> <tr> <td>01</td> <td>BIT Failure</td> </tr> <tr> <td>02</td> <td>Setup Failure</td> </tr> <tr> <td>04</td> <td>MediaPlayback</td> </tr> <tr> <td>08</td> <td>Media Busy Unable to Accept Command</td> </tr> <tr> <td>10</td> <td>No Media</td> </tr> <tr> <td>20</td> <td>Media I/O Failure</td> </tr> <tr> <td>40</td> <td>Media 90% Full</td> </tr> <tr> <td>80</td> <td>Media Full</td> </tr> <tr> <td>100</td> <td>Buffer Allocation Locked</td> </tr> <tr> <td>200</td> <td>Idle</td> </tr> <tr> <td>400</td> <td>Buffer Automation</td> </tr> <tr> <td>800</td> <td>BufferPlayback</td> </tr> <tr> <td>1000</td> <td>Erasing Local Media</td> </tr> <tr> <td>2000</td> <td>Local Media Erased</td> </tr> <tr> <td>4000</td> <td>Acquisition Start</td> </tr> <tr> <td>8000</td> <td>Media Recording</td> </tr> <tr> <td>10000</td> <td>Buffer Upload</td> </tr> <tr> <td>20000</td> <td>Buffer Download</td> </tr> <tr> <td>40000</td> <td>Buffer Recording</td> </tr> <tr> <td>80000</td> <td>Live Video</td> </tr> <tr> <td>100000</td> <td>Time Sync</td> </tr> <tr> <td>200000</td> <td>ARM</td> </tr> </tbody> </table>	Mask (Hex)	Description	01	BIT Failure	02	Setup Failure	04	MediaPlayback	08	Media Busy Unable to Accept Command	10	No Media	20	Media I/O Failure	40	Media 90% Full	80	Media Full	100	Buffer Allocation Locked	200	Idle	400	Buffer Automation	800	BufferPlayback	1000	Erasing Local Media	2000	Local Media Erased	4000	Acquisition Start	8000	Media Recording	10000	Buffer Upload	20000	Buffer Download	40000	Buffer Recording	80000	Live Video	100000	Time Sync	200000	ARM
	Mask (Hex)	Description																																													
	01	BIT Failure																																													
	02	Setup Failure																																													
	04	MediaPlayback																																													
	08	Media Busy Unable to Accept Command																																													
	10	No Media																																													
	20	Media I/O Failure																																													
	40	Media 90% Full																																													
	80	Media Full																																													
	100	Buffer Allocation Locked																																													
	200	Idle																																													
	400	Buffer Automation																																													
	800	BufferPlayback																																													
	1000	Erasing Local Media																																													
	2000	Local Media Erased																																													
	4000	Acquisition Start																																													
	8000	Media Recording																																													
	10000	Buffer Upload																																													
20000	Buffer Download																																														
40000	Buffer Recording																																														
80000	Live Video																																														
100000	Time Sync																																														
200000	ARM																																														

	400000	Trigger Mode	
	800000	Buffer Automation	
	1000000	Battery Fail	
	2000000	Over temperature	
	4000000	Invalid time Sync	
		Bits xx-xx reserved	

<b>Example</b> 	<pre>IString= 00080000</pre> <p>The string listed above indicates that the unit is in live preview mode.</p>
--------------------------------------------------------------------------------------------------	--------------------------------------------------------------------------------------------------------------

## 5.2 Image Format Control

This section describes how to influence and determine the camera/sensor image size and format. It also provides the necessary information to acquire and to display the image data. It assumes that a camera generates a single rectangular image.

The camera/sensor provides a grid of pixels the same width and height as the sensor. The DecimationHorizontal and DecimationVertical features shrink the image to a grid of pixels equivalent to Width.Max by Height.Max. In addition the features Reverse X and Reverse Y can be used to flip the image respectively along the X-axis or Y-axis. The flipping is done before the ROI is applied. Within the shrunken image an ROI can be set using the features Offset X, Offset Y, Width, and Height. The resulting image measures Width pixels by Height pixels. Offset X and Offset Y are given with respect to the upper-left corner of the image that has the coordinate (0, 0). [Figure 5](#) displays the dimensions described above. All measures are given in the unit [pixel]. As a result the values should not change if the pixel format changes. For monochrome cameras/sensors each pixel corresponds to one gray value. For color camera in raw mode (Bayer pattern, etc.) each pixel corresponds to one pixel in the color mask. For color cameras/sensors in RGB mode each pixel corresponds to one RGB triplet. For color cameras/sensors in YUV mode each pixel corresponds to one Y value with the associated color information.

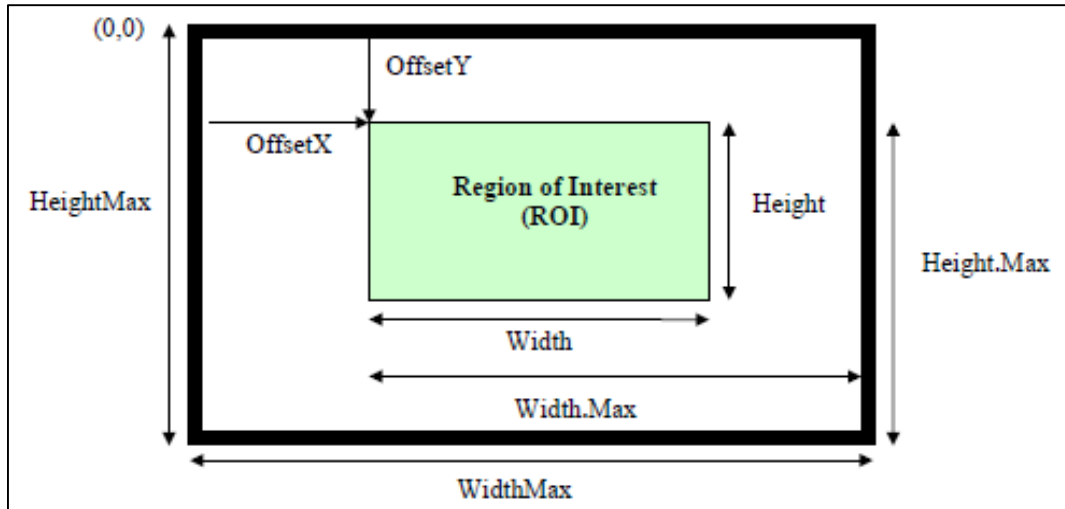

Figure 5. Image Format Control

The feature height describes the height of the image in lines. The pixels within a line are contiguous. The lines, however, may be not contiguous (e.g., in order to yield a data word alignment). Line pitch gives the number of bytes separating the starting pixels of two consecutive lines. Each pixel in the image has a format defined by pixel format. For details reference the GEV standard section on pixel formats.

The BufferSelector feature allows for buffers to have their own ROI or image format and may be utilized to set format for live stream data to be different from the one that is recorded. If a camera supports the conversion buffer feature, image format controls could be used to set the destination format for buffer reformatting on the device (e.g., for buffer contents preview). See Section 5.5 for the details. When a camera does not support multiple buffers, BufferSelector is assumed to be 0 and all the parameters control just one virtual camera buffer.

Name	GenICam	OSG	Interface	Access	Description
ImageFormatControl	R	M	ICategory	R	Category for image format control features.
BinningSelector[ <b>TransferSelector</b> ]	O	O	IEnumeration	R/W	Selects which binning engine is controlled by the BinningHorizontal and BinningVertical features.
BinningHorizontal[ <b>BufferSelector</b> ] [ <b>TransferSelector</b> ]	O	O	IInteger	R/W	Number of horizontal photosensitive cells to combine.
BinningVertical[ <b>BufferSelector</b> ] [ <b>TransferSelector</b> ]	O	O	IInteger	R/W	Number of vertical photosensitive cells to combine.
SensorWidth	M	M	IInteger	R	Effective width of the sensor in pixels.
SensorHeight	M	M	IInteger	R	Effective height of the sensor in pixels.
WidthMax	R	M	IInteger	R	Maximum width (in pixels) of the image to set ROI.
HeightMax	R	M	IInteger	R	Maximum height (in pixels) of the image to set ROI.
Width[ <b>BufferSelector</b> ] [ <b>TransferSelector</b> ]	M	M	IInteger	R/W	Width of the image provided by the device (in pixels) utilized to set ROI.

Name	GenCam	OSG	Interface	Access	Description
Height[ <b>BufferSelector</b> ] [ <b>TransferSelector</b> ]	M	M	IInteger	R/W	Height of the image provided by the device (in pixels) utilized to set ROI.
OffsetX[ <b>BufferSelector</b> ] [ <b>TransferSelector</b> ]	R	O	IInteger	R/W	Horizontal offset from the origin to the ROI (in pixels).
OffsetY[ <b>BufferSelector</b> ] [ <b>TransferSelector</b> ]	R	O	IInteger	R/W	Vertical offset from the origin to the ROI (in pixels).
DecimationHorizontal[ <b>BufferSelector</b> ] [ <b>TransferSelector</b> ]	O	O	IInteger	R/W	Horizontal sub-sampling of the image.
DecimationVertical[ <b>BufferSelector</b> ] [ <b>TransferSelector</b> ]	O	O	IInteger	R/W	Vertical sub-sampling of the image.
PixelFormat[ <b>BufferSelector</b> ] [ <b>TransferSelector</b> ]	M	M	IEnumeration	R/(W)	Format of the pixel provided by the device.
PixelCoding[ <b>BufferSelector</b> ] [ <b>TransferSelector</b> ]	R	M	IEnumeration	R/(W)	Coding of the pixels in the image.
PixelSize[ <b>BufferSelector</b> ] [ <b>TransferSelector</b> ]	R	M	IEnumeration	R/(W)	Total size in bits of a pixel of the image.
TestImageSelector[ <b>BufferSelector</b> ] [ <b>TransferSelector</b> ]	O	M	IEnumeration	R/W	Selects the type of test image that is sent by the device. Color bars are required.
ReverseX[ <b>BufferSelector</b> ] [ <b>TransferSelector</b> ]	R	O	IBoolean	R/W	Flip horizontally the image sent by the device.
ReverseY [ <b>BufferSelector</b> ] [ <b>TransferSelector</b> ]	R	O	IBoolean	R/W	Flip vertically the image sent by the device.
PixelColorFilter[ <b>BufferSelector</b> ] [ <b>TransferSelector</b> ]	R	M	IEnumeration	R/(W)	Type of color filter that is applied to the image.

### 5.3 Acquisition Control

This section describes all features related to image acquisition and transfer, including the trigger and exposure control. It describes the basic model for acquisition and the typical behavior of the device as displayed in [Figure 6](#).

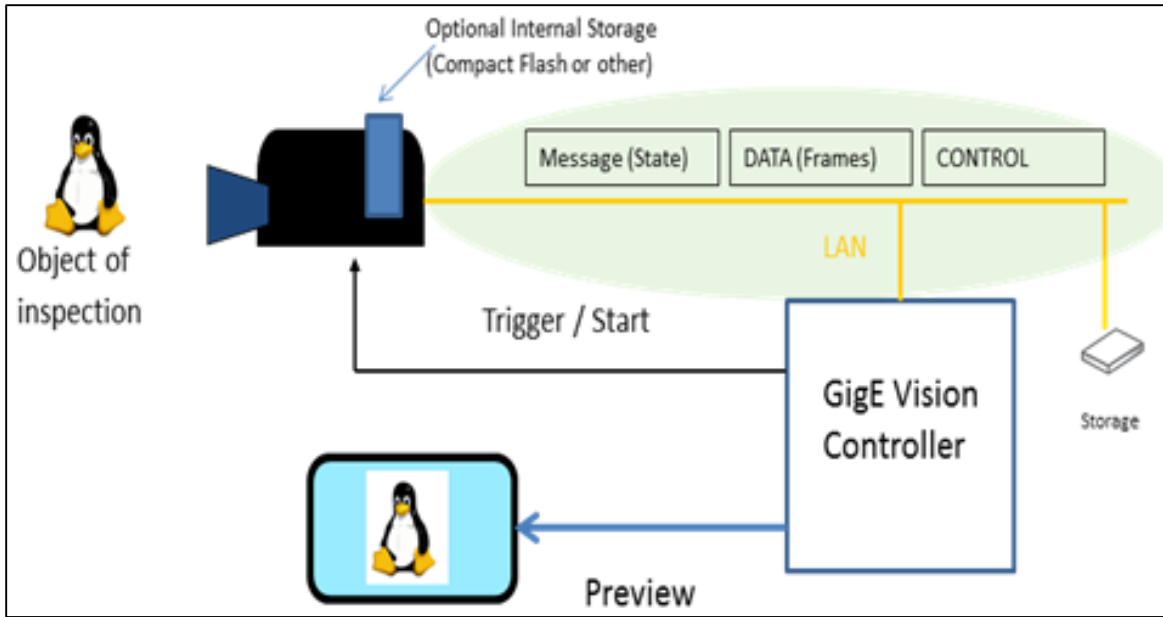

Figure 6. Acquisition Control Process

An acquisition is defined as the capture or transfer of one frame or a sequence of many frames. The start of a recording is accomplished from either a hardware or software trigger. The trigger is typically provided from a GEV primary application used by an ANCS-compliant camera. The trigger capture point may be preceded by x number of frames indicated by the Pre-Trigger custom feature. A typical acquisition is illustrated in [Figure 7](#).

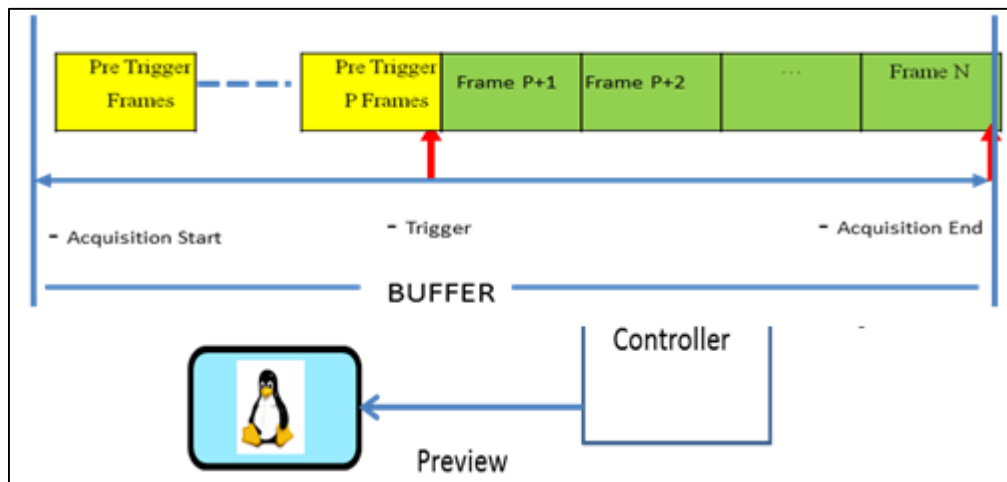

Figure 7. Trigger Capture Point

Data from the sensor may be held in a temporary buffer or recorded directly to local media. From buffer storage, data can be handled in one of three ways: it may be transferred over the network to storage media (Buffer Playback); it may be downloaded to local storage media (Buffer Download); it may be both transferred over the network and downloaded to local storage. The potential data transfer paths are shown in [Figure 8](#) below.

Recording: Sensor -> RAM or Media (BufferRecording, MediaRecording)



Playback: RAM or Media -> Ethernet (BufferPlayback, MediaPlayback)

BufferDownload: RAM -> Media

BufferUpload: Media -> RAM

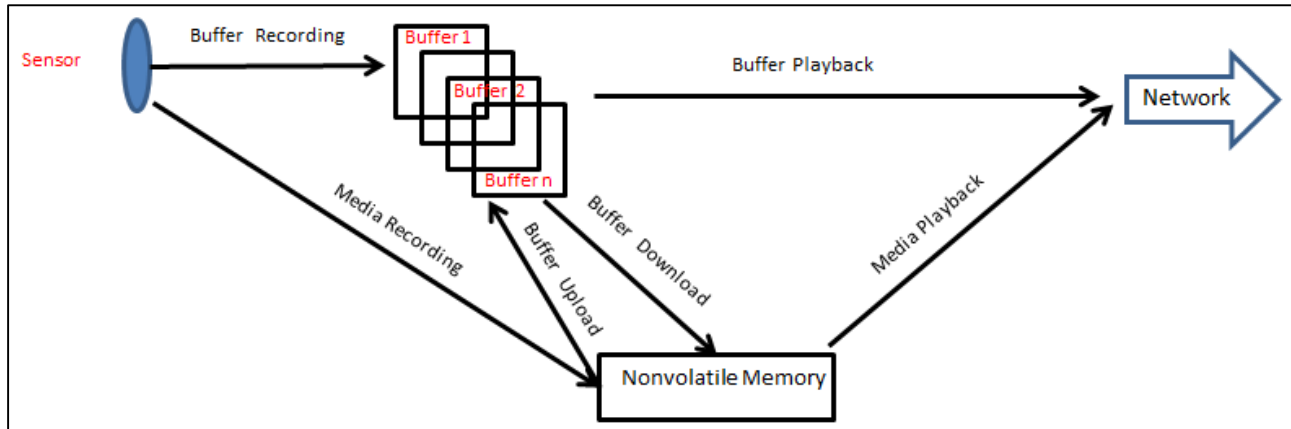

Figure 8. Data Transfer Path

The Trigger Control section describes all features related to image acquisition using one or multiple triggers. An ANCS-compliant camera may be triggered from software (over the network), external input discrete signal, or both software and external. A trigger selector is used to select which type of trigger to configure. The standard trigger types are Software Acquisition Start, Acquisition End, and a physical input line or internal signal to be used for the selected trigger.

With a software trigger source, the Trigger Software command can be used by a GEV primary application to generate an internal trigger signal. With the hardware trigger source, Trigger Activation specifies the activation mode of the trigger. This can be a Rising Edge, Falling Edge, Any Edge, Level High, or Level Low. The Trigger Delay specifies IAW the GenICam standard the delay in microseconds to apply after the trigger reception before activating it.

The transfer of the frame(s) of an acquisition starts with the beginning of the transfer of the first frame and ends with the completion of the transfer of the last one. There are several acquisition modes of ANCS-compliant cameras. The types of acquisition modes are dependent on the user specification as follows.

### 5.3.1 Continuous

Frames are continuously transferred from a GEV transmitter to a GEV receiver. If the volatile memory or media are involved in the transfer, it continues in a loop from the start of the buffer after the end of the buffer is reached.

### 5.3.2 Single Frame

A single frame is transferred from a GEV transmitter to a GEV receiver or captured to the volatile memory.

### 5.3.3 Multi-Frame

Only a specified number of frames are transferred from a GEV transmitter to a GEV receiver or captured to the volatile memory depending on the AcquisitionFrameCount setting. If

the AcquisitionFrameCount is set to zero, data will be transferred until the end of the memory (buffer of file) is reached.

#### 5.3.4 Acquisition Control Features

An ANCS-compliant camera may operate in either stand-alone mode or as an integral component in a network. In stand-alone mode a single or multiple configuration files may reside in the camera. The ANCS features are provided for selection of a configuration file.

Name	GenCam	OSG	Interface	Access	Description
AcquisitionControl	R		ICategory	R	Category for the acquisition and trigger control features.
AcquisitionMode[TransferSelector]	M	M	IEnumeration	R/(W)	Selects the type of acquisition (Single, Multiple, Continuous)
AcquisitionStart[TransferSelector][BufferSelector]	M	M	ICommand	(R)/W	Starts the acquisition of the device.
AcquisitionStop[TransferSelector][BufferSelector]	M	M	ICommand	(R)/W	Stops the acquisition of the device at the end of the current frame.
AcquisitionAbort[TransferSelector][BufferSelector]	R	M	ICommand	(R)/W	Aborts the acquisition immediately.
AcquisitionFrameCount[TransferSelector][BufferSelector]	R	O	IInteger	R/W	Number of frames to acquire in MultiFrameAcquisition mode.
AcquisitionFrameRate[TransferSelector][BufferSelector]	R	M	IFloat	R/W	Controls the acquisition rate (in hertz) at which the frames are captured.
AcquisitionPreTriggerFrameCount[BufferSelector]		C	<i>IInteger</i>	<i>R/W</i>	<i>Count of Pretrigger frames to set up.</i>
TriggerSelector[TransferSelector][BufferSelector]	R	M	IEnumeration	R/W	Selects the type of trigger to configure.
TriggerMode[BufferSelector][TriggerSelector]	R	M	IEnumeration	R/W	Controls if the selected trigger is active.
TriggerSoftware[BufferSelector][TriggerSelector]	R	M	ICommand	R/W	Generates an internal trigger.
TriggerSource[BufferSelector][TriggerSelector]	R	M	IEnumeration	R/W	Specifies the internal signal or physical input line to use as the trigger source.
TriggerDelay[BufferSelector][TriggerSelector]	R	M	IFloat	R/W	Specifies the delay in microseconds to apply after the trigger reception before activating it.
TriggerTime[TransferSelector][BufferSelector]		M	<i>IString</i>	<i>R</i>	<i>Specifies time of trigger relative to external time.</i>
TriggerDelayEnable[TransferSelector][BufferSelector]		M	IBoolean	<i>R/W</i>	<i>Delayed for the time value.</i>
TriggerDebounce[TransferSelector][BufferSelector]		O	IEnumeration	<i>R/W</i>	<i>Avoids false trigger signals.</i>
TriggerActivation[TransferSelector][BufferSelector]	R	M	IEnumeration	R/W	Specifies the activation mode of the trigger.
TriggerThreshold[TransferSelector][BufferSelector]		M	IInteger	R	Provides the host application with trigger detect threshold required
TransferSelector		M	IEnumeration	<i>R/W</i>	Selects the acquisition transfer route to control.

Name	GenICam	OSG	Interface	Access	Description
TransferStreamChannel [TransferSelector]		M	IInteger	R/W	Selects the SCP 0 or 1
AcquisitionArm[BufferSelector]		M	ICommand	R/W	<b>Initiates Pre Trigger before an Acquisition Start command.</b>
AcquisitionArmStatus[BufferSelector]		M	IEnumeration	R/W	<b>Arm state of ANCS-compliant camera</b>
AcquisitionStartTime [BufferSelector]		M	IString	R	<i>Time of acquisition Start</i>
AcquisitionArmTime [BufferSelector]		M	IString	R	<i>Time of Acquisition Arm</i>

**NOTE**  *AcquisitionMode* is a GenICam standard parameter that uses custom enumerated entries as well as standard entries. GenICam standard values for *AcquisitionMode* are *Continuous*, *Multi-frame*, and *Single Frame*.

**NOTE**  *Depending on the value of the TransferSelector feature, the AcquisitionMode, AcquisitionStart, AcquisitionStop, AcquisitionAbort, AcquisitionFrameCount, and TransferStreamChannel features are used to control acquisition ether from the live video source or buffer content.*

**NOTE**  *TriggerSelector* is typically constrained by the following.

- a. *FrameStart* - trigger signal initiates the acquisition of an individual frame. *FrameStart* is typically utilized by industrial cameras. An ANCS-compliant camera will utilize the *AcquisitionStart* and *AcquisitionStop* functions.
- b. *AcquisitionStart* - trigger signal starts the acquisition process
- c. *AcquisitionStop* - trigger signal ends the acquisition process (after it is started by the *AcquisitionStart* command).

### 5.3.5 Acquisition Control Custom Features

#### 5.3.5.1 Acquisition Mode

This feature selects the type of acquisition.

<b>Name</b>	AcquisitionMode
<b>Level</b>	Conditional
<b>Interface</b>	IEnumeration
<b>Access</b>	Read/Write
<b>Unit</b>	N/A
<b>Values</b>	0 = Single Frame 1= Multi-frame 2= Continuous

## 5.3.5.2 Acquisition Frame Count

This feature defines the number of frames to acquire.

<b>Name</b>	AcquisitionFrameCount
<b>Level</b>	Conditional
<b>Interface</b>	IInteger
<b>Access</b>	Read/Write
<b>Unit</b>	N/A
<b>Values</b>	The values identify the amount of frames to acquire or transfer. If 0 and the volatile memory is selected for the transfer, the transfer will stop when it reaches the end of the buffer or file.

## 5.3.5.3 AcquisitionPreTriggerFrameCount

This feature identifies the number of pre-trigger frames to set up for a specific buffer.

<b>Name</b>	AcquisitionPreTriggerFrameCount[BufferSelector]
<b>Level</b>	Conditional
<b>Interface</b>	IInteger
<b>Access</b>	Read/Write
<b>Unit</b>	N/A
<b>Values</b>	N/A

## 5.3.5.4 TransferSelector

This feature selects the acquisition/transfer route to control.

<b>Name</b>	TransferSelector
<b>Level</b>	Conditional
<b>Interface</b>	IEnumeration
<b>Access</b>	Read/Write
<b>Unit</b>	N/A
<b>Values</b>	0 = Live Video 1= Buffer Recording 2= Buffer Playback 3=Buffer Download 4=Buffer Upload 5= Media Recording 6= Media Playback

## 5.3.5.5 TriggerActivation

This feature defines how a trigger is detected.

<b>Name</b>	TriggerActivation[BufferSelector]
<b>Level</b>	Conditional
<b>Interface</b>	IEnumeration
<b>Access</b>	Read/Write
<b>Unit</b>	N/A

<b>Values</b>	0 = Rising Edge 1= Falling Edge 2= Any Edge
---------------	---------------------------------------------------

### 5.3.5.6 TriggerTime

This feature identifies the time the trigger is activated.

<b>Name</b>	TriggerTime
<b>Level</b>	Mandatory
<b>Interface</b>	IString
<b>Access</b>	Read
<b>Unit</b>	N/A
<b>Values</b>	String formatted as DDD HH:MM:SS:TTT:UUU where DDD is the day of the year from 1 to 366; HH is the hour from 0 to 23; MM is the minute from 0 to 59; SS is the second in the minute from 0 to 59; TTT is the millisecond from 0 to 999; UUU are the microseconds.

### 5.3.5.7 Trigger Delay Enable Feature

The trigger command will be delayed for the time value in “Trigger Delay” (in  $\mu$ s).

<b>Name</b>	TriggerDelayEnable
<b>Level</b>	Mandatory
<b>Interface</b>	IBoolean
<b>Access</b>	Read/Write
<b>Unit</b>	N/A
<b>Values</b>	True/False

### 5.3.5.8 Trigger De-Bounce Feature

The trigger de-bounce feature introduces a delay from the reception of the initial trigger signal to avoid false trigger signals due to voltage fluctuations. If the trigger signal is still active after the de-bounce period, it is then considered an actual trigger.

<b>Name</b>	TriggerDebounce
<b>Level</b>	Optional
<b>Interface</b>	IBoolean
<b>Access</b>	Read/Write
<b>Unit</b>	N/A
<b>Values</b>	True/False

### 5.3.5.9 Trigger Threshold

This feature provides the host application with the required trigger detection threshold.

<b>Name</b>	TriggerThreshold[BufferSelector]
<b>Level</b>	Mandatory
<b>Interface</b>	IInteger
<b>Access</b>	Read

<b>Unit</b>	N/A
<b>Values</b>	5VDC 3.3 VDC 28 VDC GND

#### 5.3.5.10 Acquisition Arm Status

This feature provides the arm status of an ANCS-compliant camera.

<b>Name</b>	AcquisitionArmStatus[BufferSelector]
<b>Level</b>	Conditional
<b>Interface</b>	<i>IEnumeration</i>
<b>Access</b>	Read
<b>Unit</b>	N/A
<b>Values</b>	0= Idle 1= Armed

#### 5.3.5.11 Acquisition Arm Time

This feature identifies the acquisition arm time.

<b>Name</b>	AcquisitionArmTime [BufferSelector]
<b>Level</b>	Mandatory
<b>Interface</b>	IString
<b>Access</b>	Read
<b>Unit</b>	N/A
<b>Values</b>	String formatted as DDD HH:MM:SS:TTT:UUU where DDD is the day of the year from 1 to 366; HH is the hour from 0 to 23; MM is the minute from 0 to 59; SS is the second in the minute from 0 to 59; TTT is the millisecond from 0 to 999; UUU are the microseconds.

#### 5.3.5.12 Acquisition Start Time

This feature lists the acquisition start time.

<b>Name</b>	AcquisitionStartTime [BufferSelector]
<b>Level</b>	Mandatory
<b>Interface</b>	IString
<b>Access</b>	Read
<b>Unit</b>	N/A
<b>Values</b>	String formatted as DDD HH:MM:SS:TTT:UUU where DDD is the day of the year from 1 to 366; HH is the hour from 0 to 23; MM is the minute from 0 to 59; SS is the second in the minute from 0 to 59; TTT is the millisecond from 0 to 999; UUU are the microseconds.

#### 5.3.5.13 Acquisition Arm

This feature arms the device before an AcquisitionStart command. It also initiates a pre-trigger acquisition if required by the ANCS-compliant camera.

<b>Name</b>	AcquisitionArm
<b>Level</b>	Mandatory
<b>Interface</b>	<i>ICommand</i>
<b>Access</b>	Read/Write
<b>Unit</b>	N/A
<b>Values</b>	N/A

## Example

### Preview:

```
TransferSelector ="LiveVideo "
BufferSelector=0
AcquisitionMode= Continuous
TransferStreamChannel=0
AcquisitionFrameRate=30
AcquisitionStart
```

### Capture:

```
TransferSelector ="BufferRecording"
BufferSelector=0
AcquisitionMode=MultiFrame
AcquisitionFrameCount=100
AcquisitionFrameRate=1000
AcquisitionStart
```

### Transfer:

```
TransferSelector="BufferPlayback"
BufferSelector=0
AcquisitionMode=MultiFrame
AcquisitionFrameCount=0
TransferStreamChannel=1
AcquisitionStart
```

### Postview:

```
TransferSelector="BufferPlayback"
BufferSelector=0
AcquisitionMode=Continuous
TransferStreamChannel=0
AcquisitionFrameRate=30
AcquisitionStart
```

## 5.4 Exposure Control

### 5.4.1 Exposure Control Features

The ExposureControl features describe the exposure of the photosensitive cells (shutter control) during image acquisition, which can be in three different modes. ExposureMode can be

off to disable the shutter and let it open. ExposureMode can be timed to have a timed exposure and allow programming the duration using the ExposureTime or ExposureAuto features. ExposureMode can be “Trigger Width” to use the width of the current frame or line trigger signal(s) to control exposure duration.

Name	GenICam	OSG	Interface	Access	Unit	Description
ExposureControl		R	ICategory	R		Category for the exposure control features.
ExposureMode[BufferSelector] [TransferSelector]	R	M	IEnumeration	R/W		Sets the operation mode of the exposure (or shutter).
ExposureTime[BufferSelector] [TransferSelector]	R	M	IFloat	R/W	μs	Sets the exposure time (in microseconds [μs]) when exposure mode is timed and exposure auto is off.
ExposureAuto[BufferSelector] [TransferSelector]	O	O	IEnumeration	R/W		Sets the automatic exposure mode when exposure mode is timed.
LowLight[BufferSelector] [TransferSelector]	O	O	IBoolean	R/W		Temporarily sets lighting adjustment.

## 5.4.2 Exposure Control Custom Features

### 5.4.2.1 ExposureMode

This feature sets the operation mode of the exposure (or shutter).

<b>Name</b>	ExposureMode
<b>Level</b>	Mandatory
<b>Interface</b>	IEnumeration
<b>Access</b>	Read/Write
<b>Unit</b>	N/A
<b>Values</b>	0 = Off 1 = Timed 2 = Low Light 3 = Trigger Width

### 5.4.2.2 ExposureTime

This feature sets the exposure time in cases where the ExposureMode is timed and the ExposureAuto is off.

<b>Name</b>	ExposureTime
<b>Level</b>	Mandatory
<b>Interface</b>	IFloat
<b>Access</b>	Read/Write
<b>Unit</b>	μs
<b>Values</b>	>=0

### 5.4.2.3 ExposureAuto

This feature sets the automatic exposure mode if the ExposureMode is timed.



<b>Name</b>	ExposureAuto
<b>Level</b>	Mandatory
<b>Interface</b>	IEnumeration
<b>Access</b>	Read/Write
<b>Unit</b>	N/A
<b>Values</b>	0 = Off 1 = Once 2 = Continuous

### 5.5 Buffer Control

An ANCS-compliant camera may provide volatile memory to be segmented into different buffers. The intent is to be able to accomplish multiple data acquisitions without having to wait for download or transfer of data.

When an ANCS-compliant camera supports multiple buffers as illustrated in [Figure 9](#), acquisition-related features are based on the selected buffer. A buffer represents intermediate entity between actual acquisition and streaming. In operation when the ANCS-compliant camera makes an acquisition, the acquired data goes into a specific buffer and when the device streams, it streams the content of a selected buffer.

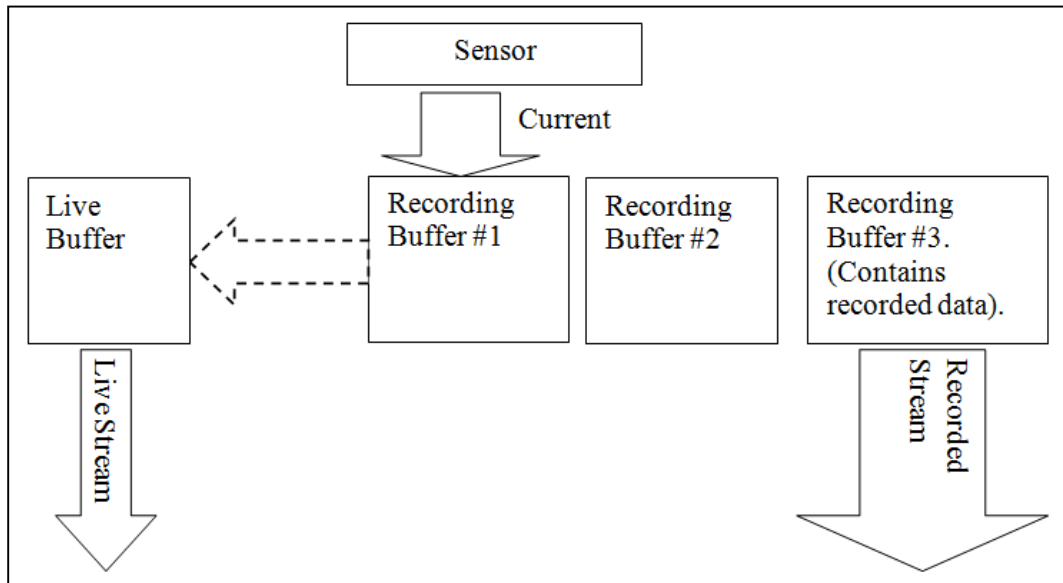

Figure 9. Buffered Acquisition and Streaming

#### 5.5.1 Buffer Control Features

Name	OSC	Interface	Access	Description
<b>BufferControl</b>	C	ICategory	R	Category that contains the buffer control features.
<b>BufferAllocationLocked</b>	C	IBoolean	R/W	Lock or unlock the current allocation state of all buffers.

Name	OSG	Interface	Access	Description
<b>TotalMemorySize</b>	C	IInteger	R	Total size of memory available for buffer allocations in bytes.
<b>FreeMemorySize</b>	C	IInteger	R	Size of memory block not allocated by any buffer.
<b>BufferFrameCount[BufferSelector]</b>	C	IInteger	R/W	Buffer length in frames allocated or to be allocated. If 0, the buffer will be collapsed to zero size.
<b>BufferSize[BufferSelector]</b>	C	IInteger	R/W	Size of selected buffer in bytes allocated or to be allocated. If 0, the buffer will be collapsed to zero size.
<b>BufferFrameSize[BufferSelector]</b>	C	IInteger	R	Size of one frame stored or to be recorded in the selected buffer.
<b>BufferRecordedFrameCount [BufferSelector]</b>	O	IInteger	R	Number of frames recorded in the buffer.
<b>BufferCount</b>	C	IInteger	R/W	Number of buffers currently allocated or to be allocated. If 0, all buffers will be deleted.
<b>BufferSelector</b>	C	IInteger	R/W	Select a particular buffer by index to control and get info.
<b>BufferStatus[BufferSelector]</b>	C	IEnumeration	R	Status of the selected buffer [“Empty”, “Full”, “Busy”, “Stored”].
<b>BufferTriggerTime[BufferSelector]</b>		IInteger	R	Timestamp of a recording trigger in selected buffer.
<b>BufferAutomation</b>	C	IBoolean	R/W	Proceed to NextBuffer when current buffer recording or playback is finished.
<b>BufferRemainingFrameCount</b>	C	IInteger	R/W	Number of remaining frames (unused volatile memory), in frames.
<b>BufferProgress[BufferSelector]</b>	C	IInteger	R	The progress of the current buffer operation, in %.
<b>BufferBusy[BufferSelector]</b>	C	IBoolean	R	True if selected buffer is involved in the acquisition process with the currently selected source.
<b>BufferActiveIndex</b>	C	IInteger	R	Index of the buffer currently being transferred. Can be different from BufferSelector during the automation.
<b>BufferRecordedFrameRate [BufferSelector]</b>	C	IInteger	R	Frame rate of the selected buffer.
<b>BufferDecimation[BufferSelector]</b>	C	IBoolean	R/W	If true, the playback frame rate will be decimated to make the perceived speed of video match the speed of the recorded video.
<b>IndividualBufferSettingsEnabled</b>	C	IBoolean	R/W	The buffer and acquisition control features apply to all buffers regardless of the BufferSelector parameter when false.
<b>BufferAcquisitionTime [BufferSelector]</b>	M	IInteger	R	Time of buffer acquisition start.
<b>BufferArmTime [BufferSelector]</b>	M	IInteger	R	Time the buffer is armed.

## 5.5.2 Buffer Control Custom Features

### 5.5.2.1 BufferControl Category

This feature is the category for the buffer control features.

<b>Name</b>	BufferControl
<b>Level</b>	Conditional
<b>Interface</b>	ICategory
<b>Access</b>	Read
<b>Unit</b>	N/A
<b>Values</b>	N/A

#### 5.5.2.2 BufferAllocationLocked

This feature locks the existing state of the buffers.

<b>Name</b>	BufferControl
<b>Level</b>	Conditional
<b>Interface</b>	IBoolean
<b>Access</b>	Read
<b>Unit</b>	N/A
<b>Values</b>	True= Locks all Buffers False = Unlocks Buffers

#### 5.5.2.3 Total Memory Size

This feature identifies the device's total memory size available for buffer fragmentation.

<b>Name</b>	TotalMemorySize
<b>Level</b>	Conditional
<b>Interface</b>	IInteger
<b>Access</b>	Read
<b>Unit</b>	Bytes
<b>Values</b>	N/A

#### 5.5.2.4 Free Memory Size

This feature identifies the memory size left unallocated.

<b>Name</b>	FreeMemorySize
<b>Level</b>	Conditional
<b>Interface</b>	IInteger
<b>Access</b>	Read
<b>Unit</b>	Bytes
<b>Values</b>	N/A

#### 5.5.2.5 BufferFrameCount

This feature provides the number of frames in the selected buffer.

<b>Name</b>	BufferFrameCount[BufferSelector]
<b>Level</b>	Conditional
<b>Interface</b>	IInteger
<b>Access</b>	Read/Write
<b>Unit</b>	N/A

<b>Values</b>	N/A
---------------	-----

5.5.2.6 BufferSize

This feature lists the buffer size in bytes. BufferSize should be greater or equal to BufferFrameSize. If BufferSize is 0 or less than BufferFrameSize buffer cannot be used for recording or streaming and is considered to be inactive. BufferSize can be changed only if all other buffers are empty.

<b>Name</b>	BufferSize[BufferSelector]
<b>Level</b>	Conditional
<b>Interface</b>	IInteger
<b>Access</b>	Read/Write
<b>Unit</b>	Bytes
<b>Values</b>	N/A

5.5.2.7 BufferFrameSize

This feature is the size of one acquisition frame in current conditions (ROI, pixel depth). This is in-buffer frame size and might be different from PayloadSize, because of different buffer frame formats.

<b>Name</b>	BufferFrameSize[BufferSelector]
<b>Level</b>	Conditional
<b>Interface</b>	IInteger
<b>Access</b>	Read
<b>Unit</b>	Bytes
<b>Values</b>	N/A

5.5.2.8 BufferRecordedFrameCount

This feature is the number of frames that have been recorded in the selected buffer.

<b>Name</b>	BufferRecordedFrameCount [BufferSelector]
<b>Level</b>	Conditional
<b>Interface</b>	IInteger
<b>Access</b>	Read
<b>Unit</b>	N/A
<b>Values</b>	N/A

5.5.2.9 BufferCount

This feature is for the number of buffers currently allocated.

<b>Name</b>	BufferCount
<b>Level</b>	Conditional
<b>Interface</b>	IInteger
<b>Access</b>	Read
<b>Unit</b>	N/A
<b>Values</b>	N/A

5.5.2.10 BufferSelector

This feature selects a buffer to control and obtain information from.

<b>Name</b>	BufferSelector
<b>Level</b>	Conditional
<b>Interface</b>	IInteger
<b>Access</b>	Read
<b>Unit</b>	N/A
<b>Values</b>	N/A

5.5.2.11 BufferStatus

This feature provides the status of the selected buffer.

<b>Name</b>	BufferStatus[BufferSelector]
<b>Level</b>	Conditional
<b>Interface</b>	IEnumeration
<b>Access</b>	Read
<b>Unit</b>	N/A
<b>Values</b>	0: Empty 1: Full 2. Busy : In progress of transfer to local media 3. Stored : Buffer has been stored to local media

5.5.2.12 BufferTriggerTime

This feature contains the time of data capture.

<b>Name</b>	BufferTriggerTime[BufferSelector]
<b>Level</b>	Conditional
<b>Interface</b>	IInteger
<b>Access</b>	Read
<b>Unit</b>	μs
<b>Values</b>	>0

5.5.2.13 BufferAutomation

This feature sets or disables the automatic proceeding to the next buffer when the current buffer acquisition is completed.

<b>Name</b>	BufferAutomation
<b>Level</b>	Conditional
<b>Interface</b>	IBoolean
<b>Access</b>	(Read)/Write
<b>Unit</b>	N/A
<b>Values</b>	False True - Step to next buffer after acquisition or playback

## 5.5.2.14 BufferRemainingFrameCount

This feature outputs the size of unused volatile memory that's available to be allocated to a new buffer.

<b>Name</b>	BufferRemainingFrameCount
<b>Level</b>	Conditional
<b>Interface</b>	IInteger
<b>Access</b>	Read
<b>Unit</b>	Bytes
<b>Values</b>	0 or greater

## 5.5.2.15 BufferProgress

This feature outputs the percent complete of buffer operation (recording, playback, download, upload).

<b>Name</b>	BufferProgress[BufferSelector]
<b>Level</b>	Conditional
<b>Interface</b>	IInteger
<b>Access</b>	Read
<b>Unit</b>	N/A
<b>Values</b>	0 or greater

## 5.5.2.16 BufferBusy

This feature outputs the state of a buffer.

<b>Name</b>	BufferBusy[BufferSelector]
<b>Level</b>	Conditional
<b>Interface</b>	IBoolean
<b>Access</b>	Read
<b>Unit</b>	N/A
<b>Values</b>	False True

## 5.5.2.17 BufferActiveIndex

This feature displays the index number of the currently selected buffer.

<b>Name</b>	BufferActiveIndex[TransferSelector]
<b>Level</b>	Conditional
<b>Interface</b>	IInteger
<b>Access</b>	Read
<b>Unit</b>	N/A
<b>Values</b>	$\geq 0$

## 5.5.2.18 BufferRecordedFrameRate

This feature lists the recorded frame rate of the selected buffer.

<b>Name</b>	BufferRecordedFrameRate[BufferSelector]
-------------	-----------------------------------------

<b>Level</b>	Conditional
<b>Interface</b>	IInteger
<b>Access</b>	Read
<b>Unit</b>	Hz
<b>Values</b>	>0

#### 5.5.2.19 BufferDecimation

This feature outputs the decimated frame rate for playback utilizing SCP0.

<b>Name</b>	BufferDecimation[BufferSelector]
<b>Level</b>	Conditional
<b>Interface</b>	IBoolean
<b>Access</b>	Read
<b>Unit</b>	Hz
<b>Values</b>	True/False

#### 5.5.2.20 Buffer Acquisition Time

This feature outputs the time of buffer acquisition.

<b>Name</b>	BufferAcquisitionTime[BufferSelector]
<b>Level</b>	Mandatory
<b>Interface</b>	IInteger
<b>Access</b>	Read
<b>Unit</b>	N/A
<b>Values</b>	N/A

#### 5.5.2.21 BufferArmTime

This feature outputs the time at which the buffer was armed.

<b>Name</b>	BufferArmTime[BufferSelector]
<b>Level</b>	Mandatory
<b>Interface</b>	IInteger
<b>Access</b>	Read

#### 5.5.2.22 IndividualBufferSettings

This feature defines if control features apply to a single buffer or to all buffers.

<b>Name</b>	IndividualBufferSettingsEnabled
<b>Level</b>	Conditional
<b>Interface</b>	IBoolean
<b>Access</b>	Read
<b>Unit</b>	N/A
<b>Values</b>	True = Control features apply to individual buffers. False = IndividualBufferSettings is not used, features apply to all buffers.

**Example**

The following features allocate a single buffer over all available memory (the default allocation).

```
BufferAllocationLocked=False
BufferCount=1
BufferSelector=0
BufferSize=TotalMemorySize
BufferAllocationLocked=True
```

The following features allocate two buffers of 200 frames with 100 pre-trigger frames.

```
BufferAllocationLocked=False
BufferCount=2
BufferSelector=0
BufferFrameCount=200
AcquisitionPreTriggerFrameCount=100
BufferSelector=1
BufferFrameCount=200
AcquisitionPreTriggerFrameCount=100
BufferAllocationLocked=True
```

The following features divide all memory equally over three buffers.

```
BufferAllocationLocked=False
BufferCount=3
BufferSelector=0
BufferSize=FreeMemorySize / 3
BufferSelector=1
BufferSize=FreeMemorySize / 2
BufferSelector=2
BufferSize=FreeMemorySize
BufferAllocationLocked=True
```

**Example**

The following features allocate three buffers of 1000 frames and set recording to the buffers to the BufferAutomation mode.

```
GVCP> BufferAllocationLocked=False
GVCP> BufferCount=3
GVCP> TransferSelector=BufferRecording
GVCP> BufferSelectorEnabled=False
GVCP> Width=1600
GVCP> Height=1200
GVCP> BufferFrameCount=1000
GVCP> BufferFrameCount=1000
```



	<pre> GVCP&gt; BufferAllocationLocked=True GVCP&gt; ExposureTime=1500 GVCP&gt; AcquisitionFrameRate=500 GVCP&gt; AcquisitionMode=Continuous GVCP&gt; TriggerSelector=AcquisitionStart GVCP&gt; TriggerSource=Software GVCP&gt; TriggerMode=True GVCP&gt; BufferAutomation=True GVCP&gt; AcquisitionStart() GVCP&gt;SoftwareTrigger() GVCP&gt;SoftwareTrigger() GVCP&gt;SoftwareTrigger() </pre> <p>The following features set transferring multi-buffer data on the SCP1 in the BufferAutomation mode.</p> <pre> GVCP&gt; TransferSelector=BufferPlayback GVCP&gt; BufferSelectorEnabled=False GVCP&gt; AcquisitionMode=MultiFrame GVCP&gt; AcquisitionFrameCount=BufferRecordedFrameCount GVCP&gt; TransferStreamChannel=1 GVCP&gt; BufferAutomation=True GVCP&gt; AcquisitionStart() </pre> <p>The following features set playing back multi-buffer data on the SCP0 in the BufferAutomation mode.</p> <pre> GVCP&gt; TransferSelector=BufferPlayback GVCP&gt; BufferSelectorEnabled=False GVCP&gt; Width=640 GVCP&gt; Height=480 GVCP&gt; AcquisitionFrameRate=30 GVCP&gt; AcquisitionMode=Continuous GVCP&gt; TransferStreamChannel=0 GVCP&gt; BufferAutomation=True GVCP&gt; AcquisitionStart() GVCP&gt; AcquisitionStop() </pre>
--	----------------------------------------------------------------------------------------------------------------------------------------------------------------------------------------------------------------------------------------------------------------------------------------------------------------------------------------------------------------------------------------------------------------------------------------------------------------------------------------------------------------------------------------------------------------------------------------------------------------------------------------------------------------------------------------------------------------------------------------------------------------------------------------------------------------------------------------------------------------------------------------------------------------------------------------------------------------------------------------------------------------------------------------------------------------------------------------------------------------------------------------------------------------------------------------------------------------------------------------

## 5.6 Local Media Control

An ANCS-compliant camera that provides local storage media shall transfer the images from volatile memory to local storage IAW Section [7.4](#) of this standard. Images from multiple buffers may be transferred to a single file or multiple files.

### 5.6.1 Local Media Control Features

Name	GenCam	OSG	Interface	Access	Unit	Description
<b>LocalMediaControl</b>	R	C	<i>ICategory</i>	R		Category that contains the Local Media control features.
<b>MediaFileSelector</b>	R	C	<i>IInteger</i>	R/W		Selects the target file in the device.
<b>MediaFileSize</b> <b>[MediaFileSelector]</b>	R	C	<i>IInteger</i>	R		Represents the size of the selected file in bytes.
<b>AutoBufferSave</b>		C	<i>IEnumeration</i>	R/W		<i>Configures the ANCS-compliant camera to automatically save the captured data within a buffer to local media.</i>
<b>EraseMedia</b>		C	<i>ICommand</i>			<i>Resets the STANAG Directory.</i>
<b>NumberofFiles</b>		C	<i>IInteger</i>	R/W		<i>Number of files in the media.</i>
<b>MediaStatus</b>		C	<i>IEnumeration</i>	R/W		<i>Status of local media.</i>
<b>FreeMediaSize</b>			<i>IInteger</i>	R		<i>Total size of media available for storage of acquisitions.</i>
<b>MultiFile</b>		C	<i>IBoolean</i>			<i>Provides s either a single file or multiple files per buffer.</i>

### 5.6.2 Local Media Custom Features

#### 5.6.2.1 Local Media Control Feature

This feature is the category for the local media control features.

<b>Name</b>	LocalMediaControl
<b>Level</b>	Conditional
<b>Interface</b>	<i>ICategory</i>
<b>Access</b>	Read
<b>Unit</b>	N/A
<b>Values</b>	N/A

#### 5.6.2.2 MediaFileSelector

This feature selects the file number in media.

<b>Name</b>	MediaFileSelector
<b>Level</b>	Mandatory
<b>Interface</b>	<i>IInteger</i>
<b>Access</b>	Read
<b>Unit</b>	N/A
<b>Values</b>	$\geq 0$

#### 5.6.2.3 MediaFileSize

This feature provides the size in bytes of the selected file.

<b>Name</b>	MediaFileSize[MediaFileSector]
<b>Level</b>	Mandatory

<b>Interface</b>	IInteger
<b>Access</b>	Read
<b>Unit</b>	N/A
<b>Values</b>	$\geq 0$

#### 5.6.2.4 AutoBufferSave

This feature defines when the buffer is saved.

<b>Name</b>	AutoBufferSave
<b>Level</b>	Conditional
<b>Interface</b>	IEnumeration
<b>Access</b>	Read
<b>Unit</b>	N/A
<b>Values</b>	0- Commanded 1- AfterEachBuffer 2- AfterLastBuffer

 <b>NOTE</b>	If the AfterEachBuffer feature is selected, the data will be saved after it has been captured for the selected buffer.
--------------------------------------------------------------------------------------------------	------------------------------------------------------------------------------------------------------------------------

 <b>NOTE</b>	If the AfterLastBuffer feature is selected, the data from all the buffers will be saved upon completion of capture in the last buffer.
---------------------------------------------------------------------------------------------------	----------------------------------------------------------------------------------------------------------------------------------------

#### 5.6.2.5 EraseMedia Feature

This feature is the command to erase the media residing in the camera. Only the directory block needs to be erased or rewritten.

<b>Name</b>	EraseMedia
<b>Level</b>	Mandatory
<b>Interface</b>	ICommand
<b>Access</b>	R/W
<b>Unit</b>	N/A
<b>Values</b>	N/A

#### 5.6.2.6 NumberofFiles Feature

This feature returns the number of files in the camera.

<b>Name</b>	NumberofFiles
<b>Level</b>	Mandatory
<b>Interface</b>	IInteger
<b>Access</b>	Read
<b>Unit</b>	N/A
<b>Values</b>	$\geq 0$

 <b>NOTE</b>	An on-board camera may have multiple files IAW Section <a href="#">7.4</a> of this standard. Each file corresponds to an acquisition; or a single file may have multiple acquisitions.
-----------------------------------------------------------------------------------------------	----------------------------------------------------------------------------------------------------------------------------------------------------------------------------------------

#### 5.6.2.7 Media Status Feature

The feature returns the status of media residing in the camera.

<b>Name</b>	MediaStatus
<b>Level</b>	Mandatory
<b>Interface</b>	IEnumeration
<b>Access</b>	Read
<b>Unit</b>	N/A
<b>Values</b>	0: OK 1: Full 2: Erased 3: Fault

#### 5.6.2.8 FreeMediaSize

This feature returns the total size of media available for acquisition storage.

<b>Name</b>	FreeMediaSize
<b>Level</b>	Mandatory
<b>Interface</b>	IInteger
<b>Access</b>	Read
<b>Unit</b>	N/A
<b>Values</b>	$\geq 0$

#### 5.6.2.9 MultiFile Selector Feature

This feature provides either a single file or multiple files per buffer.

<b>Name</b>	MultiFile
<b>Level</b>	Mandatory
<b>Interface</b>	IBoolean
<b>Access</b>	N/A
<b>Unit</b>	N/A
<b>Values</b>	True: Single File False: Multiple Files

<b>Example</b> #1 	<p>The following features configure saving automatically to local media.</p> <pre>TransferSelector = BufferRecording BufferSelector = 0 AutoSave = AfterEachBuffer AcquisitionMode = Continuous</pre>
----------------------------------------------------------------------------------------------------------	-------------------------------------------------------------------------------------------------------------------------------------------------------------------------------------------------------

	<pre>AcquisitionStart() ... SoftwareTrigger ... //BufferRecording will be completed //Auto start saving to local media AcquisitionStop()</pre>
--	------------------------------------------------------------------------------------------------------------------------------------------------

<p><b>Example #2</b> </p>	<p>The following features configure transferring files from local media.</p> <pre>//----- TransferSelector = MediaPlayerback AcquisitionMode = Continuous FileSelector = 0 AcquisitionStart() ... //File 0 will be streamed over selected SCP AcquisitionStop()</pre>
------------------------------------------------------------------------------------------------------------	-----------------------------------------------------------------------------------------------------------------------------------------------------------------------------------------------------------------------------------------------------------------------

<p><b>Example #3</b> </p>	<p>The following features configure saving manually to local media.</p> <pre>//----- TransferSelector = BufferRecording BufferSelector = 0 AutoSave = Disable AcquisitionMode = Continuous AcquisitionStart() ... SoftwareTrigger ... //BufferRecording will be completed  AcquisitionStop()  TransferSelector = MediaRecording BufferSelector = 0 AcquisitionMode = Continuous AcquisitionStart() ... //Buffer will be saved in local media ... AcquisitionStop()</pre>
-------------------------------------------------------------------------------------------------------------	--------------------------------------------------------------------------------------------------------------------------------------------------------------------------------------------------------------------------------------------------------------------------------------------------------------------------------------------------------------------------------------------------------------------------------------------------------------------------

### 5.7 Digital I/O Control

Digital I/O covers the features required to control the general input and output signals of the device. This includes input and output control signals for triggers, timers, counters, and static signals such as user-configurable input or output bits. The digital I/O control section models each I/O line as a physical line that comes from the device connector and that goes into an I/O control block, permitting the device to condition and to monitor the incoming or outgoing signal.

Name	GenICam	OSG	Interface	Access	Unit	Description
DigitalIOControl	R	O	ICategory	R		Category that contains the digital input and output control features.
LineSelector	R	C	IEnumeration	R/W		Selects the physical line (or pin) of the external device connector to configure.
LineMode[LineSelector]	O	C	IEnumeration	R/W		Controls if the physical line is used to input or output a signal.
LineInverter[LineSelector]	R	C	IBoolean	R/W		Controls the inversion of the signal of the selected input or output line.
LineStatus[LineSelector]	R	C	IBoolean	R		Returns the current status of the selected input or output line.
LineSource[LineSelector]	R	C	IEnumeration	R/W		Selects which internal acquisition or I/O source signal to output on the selected line.
UserOutputSelector	R	C	IEnumeration	R/W		Selects which bit of the user output register will be set by user output value.
UserOutputValue [UserOutputSelector]	R	C	IBoolean	R/W		Sets the value of the bit selected by user output selector.

### 5.8 Event Control

A requirement is for an ANCS-compliant camera to provide state and status messages to the host application IAW the GEV standard. Messages are utilized to notify the host application that events have occurred. Event and status may be provided by utilization of GigE event messages and polling for status by the host application. This standard provides for predefined device-specific events defined by the EventSelector feature. A requirement is for both EVENT and EVENT DATA messages to be provided. For EVENT DATA the first 4 bytes of data shall consist of the buffer index number, and the next 4 bytes shall consist of status data (i.e., percentage remaining) as denoted in [Figure 10](#). The remaining 532 bytes will be reserved and may not be used to denote any camera functionality.

0x42	Flag	Command=EVENTDATA_CMD
Length		Req_id
Stream Channel Index		Block_ID for event
Time Stamp For Event (High Part)		
Time Stamp For Event (Low Part)		
4 Data Bytes (Buffer Counter)	4 Data Bytes (Camera Data)	532 Data Bytes Reserved

Figure 10. Event Message

5.8.1 Event Control Features

Name	GenICam	OSG	Interface	Access	Unit	Description
EventControl	R	M	ICategory	R		Category that contains event control features.
EventSelector	R	M	IEnumeration	R/W		Selects which event to signal.
PollEventStatus[EventSelector]	R	M	IBoolean	R		Returns the state of the event number.
EventNotification[EventSelector]	R	M	IEnumeration	R/W		Activate or deactivate the notification of the occurrence of the selected event.
EventAcquisitionTriggerData	R	M	ICategory	R		Category that contains AcquisitionTrigger event control features.
EventAcquisitionTrigger	R	M	IInteger	R		Returns the TriggerEvent ID 36885.
<b>EventAcquisitionTriggerTimestamp</b>		M	IInteger	R		Returns the timestamp of the AcquisitionTrigger event. It can be used to determine precisely when the event occurred.
<b>EventAcquisitionTriggerBufferID</b>		M	IInteger	R		Returns the unique identifier of the buffer that generated the event.
<b>EventFrameStartData</b>		M	ICategory	R		Category that contains FrameStart event control features.
<b>EventFrameStart</b>		M	IInteger	R		Returns the FrameStart event ID equal to 36875.
<b>EventFrameStartTimestamp</b>		M	IInteger	R		Returns the timestamp of the FrameStart event.
<b>EventAcquisitionFrameStartFrameID</b>		M	IInteger	R		Returns Block ID of the frame associated with the FrameStart event.
<b>EventMediaErrorData</b>		M	ICategory	R		Category that contains media error event control features.
<b>EventMediaError</b>		M	IInteger	R		Returns the media error ID that is equal to 36916.
<b>EventMediaErrorTimestamp</b>		M	IInteger	R		Returns the timestamp of the MediaError event.
<b>EventOverTemperatureData</b>		M	ICategory	R		Category that contains OverTemperature event features.
<b>EventOverTemperature</b>		M	IInteger	R		Returns the OverTemperature ID that is equal to 36917.
<b>EventOverTemperatureTimestamp</b>		M	IInteger	R		Returns the timestamp of the OverTemperature event.
<b>EventBatteryFailData</b>		C	ICategory	R		Category that contains battery fail event features.
<b>EventBatteryFail</b>		C	IInteger	R		Returns the BatteryFail ID that is equal to 36918.

Name	GenICam	OSG	Interface	Access	Unit	Description
<b>EventBatteryFailTimestamp</b>		C	Integer	R		Returns the timestamp of the BatteryFail event.
<b>TestMessage</b>		O	IEnumeration	R/W	2	Provides a test message.
<b>EventTimeSyncData</b>		M	ICategory	R		Category that contains TimeSync event features.
<b>EventTimeSync</b>		M	Integer	R		Returns the time sync ID that is equal to 36919.
<b>EventTimeSyncTimestamp</b>		M	Integer	R		Returns the timestamp of the TimeSync event.
<b>EventInvalidTimeSyncData</b>		M	ICategory	R		Category that contains InvalidTimeSync event features.
<b>EventInvalidTimeSync</b>		M	Integer	R		Returns the invalid time ID that is equal to 36920.
<b>EventInvalidTimeSyncTimestamp</b>		M	Integer	R		Returns the Timestamp of the InvalidTimeSync Event.
<b>EventAcquisitionEndData</b>		M	ICategory	R		Category that contains acquisition end event features.
<b>EventAcquisitionEnd</b>		M	Integer	R		Returns the acquisition end event ID that is equal to 36921.
<b>EventAcquisitionEndTimestamp</b>		M	Integer	R		Returns timestamp of the AcquisitionEnd event.
<b>EventAcquisitionEndBufferID</b>		M	Integer	R		Returns the unique identifier of the buffer that generated the event.
<b>EventAcquisitionEndTransferMode</b>		M	IEnumeration	R		Returns the transfer mode of the AcquisitionEnd event (see TransferSelector for values).
<b>EventAcquisitionArmData</b>		M	ICategory	R		Category that contains acquisition arm event features.
<b>EventAcquisitionArm</b>		M	Integer	R		Returns the acquisition arm event ID that is equal to 36865.
<b>EventAcquisitionArmTimestamp</b>		M	Integer	R		Returns timestamp of the AcquisitionArm event.
<b>EventAcquisitionStartData</b>		M	ICategory	R		Category that contains acquisition start event features.
<b>EventAcquisitionStart</b>		M	Integer	R		Returns the AcquisitionStart event ID that is equal to 36933.
<b>EventAcquisitionStartTimestamp</b>		M	Integer	R		Returns timestamp of the AcquisitionStart event.
<b>EventOneRemainingAcquisitionStorageData</b>		O	ICategory	R		Category that contains one remaining acquisition storage event feature.
<b>EventOneRemainingAcquisitionStorage</b>		O	Integer	R		Returns the one remaining acquisition storage ID that is equal to 36924.



Name	GenICam	OSG	Interface	Access	Unit	Description
<b>EventOneRemainingAcquisitionStorageTimestamp</b>		O	Integer	R		Returns the timestamp of the one remaining acquisition storage event.
<b>EventOneRemainingAcquisitionStorageBufferID</b>		M	Integer	R		Returns the unique identifier of the buffer that generated the event.
<b>EventMotionDetectedData</b>	R	C	ICategory	R		Category that contains MotionDetected event features.
<b>EventMotionDetected</b>		C	Integer	R		Returns the motion detected ID that is equal to 36925.
<b>EventMotionDetectedTimestamp</b>		C	Integer	R		Returns timestamp of the motion detection event.
<b>EventMediaFullData</b>		C	ICategory	R		Category that contains MediaFull event features.
<b>EventMediaFull</b>		C	Integer	R		Returns the MediaFull ID that is equal to 36926.
<b>EventMediaFullTimestamp</b>		C	Integer	R		Returns the timestamp of the MediaFull event.
<b>EventNextBufferSelectedData</b>		M	ICategory	R		Category that contains next buffer selected event features.
<b>EventNextBufferSelected</b>		M	Integer	R		Returns the next buffer selected ID that is equal to 36927.
<b>EventNextBufferSelectedTimestamp</b>		M	Integer	R		Returns the timestamp of the next buffer selected event.
<b>EventNextBufferSelectedBufferID</b>		M	Integer	R		Returns buffer index of the next selected buffer.
<b>EventMultiBufferDownloadCompleteData</b>		M	ICategory	R		Category that contains multi-buffer download complete event features.
<b>EventMultiBufferDownloadComplete</b>		M	Integer	R		Returns the buffer multi-download complete ID that is equal to 36928.
<b>EventMultiBufferDownloadCompleteTimestamp</b>		M	Integer	R		Returns the timestamp of the multi-buffer download event.
<b>EventBufferUploadProgressData</b>		M	ICategory	R		Category that contains buffer transfer progress event features.
<b>EventBufferUploadProgress</b>		M	Integer	R		Returns buffer upload progress event ID that is equal to 36939.
<b>EventBufferUploadTimestamp</b>		M	Integer	R		Returns the timestamp of the buffer transfer progress event.
<b>EventBufferUploadProgressBufferID</b>		M	Integer	R		Returns the buffer index currently being transferred.
<b>EventBufferUploadProgressPercentage</b>		M	Integer	R		Returns the percentage transfer.

Name	GenICam	OSG	Interface	Access	Unit	Description
<b>EventBufferUploadComplete</b>		M	Integer	R		Returns the buffer multi-download complete ID that is equal to 36937.
<b>EventBufferRecordingProgressData</b>		C	ICategory	R		Category that contains buffer recording progress event features.
<b>EventBufferRecordingProgress</b>		C	Integer	R		Returns the buffer recording progress event ID that is equal to 36929.
<b>EventBufferRecordingProgressTimestamp</b>		C	Integer	R		Returns the timestamp of the buffer recording progress event.
<b>EventBufferRecordingProgressBufferID</b>		C	Integer	R		Returns the buffer index currently being recorded.
<b>EventBufferRecordingProgressPercentage</b>		C	Integer	R		Returns the percentage of the buffer recording progress.
<b>EventMediaPlaybackProgressData</b>		C	ICategory	R		Category that contains buffer media playback progress event features.
<b>EventMediaPlaybackProgress</b>		C	Integer	R		Returns the media playback progress event ID that is equal to 36922.
<b>EventMediaPlaybackProgressTimestamp</b>		C	Integer	R		Returns the timestamp of the media playback progress event.
<b>EventMediaPlaybackBufferID</b>		C	Integer	R		Returns the index of the buffer currently being downloaded.
<b>EventMediaPlaybackPercentage</b>		C	Integer	R		Returns the percentage of the media playback .
<b>EventBufferDownloadProgressData</b>		M	ICategory	R		Category that contains buffer transfer progress event features.
<b>EventBufferDownloadProgress</b>		M	Integer	R		Returns buffer download progress event ID that is equal to 36931.
<b>EventBufferDownloadProgressTimestamp</b>		M	Integer	R		Returns the timestamp of the buffer transfer progress event.
<b>EventBufferDownloadCompleteData</b>		M	ICategory	R		Category that contains multi-buffer download complete event features.
<b>EventBufferDownloadComplete</b>		M	Integer	R		Returns the buffer multi-download complete ID that is equal to 36932.
<b>EventBufferDownloadComplete Timestamp</b>		M	Integer	R		Returns the timestamp of the multi-buffer download event.
<b>EventMultiBufferRecordingCompleteData</b>		M	ICategory	R		Category that contains multi-buffer download complete event features.

Name	GenICam	OSG	Interface	Access	Unit	Description
<b>EventMultiBufferRecordingComplete</b>		M	IInteger	R		Returns the buffer multi-download complete ID that is equal to 36930.
<b>EventMultiBufferRecordingComplete Timestamp</b>		M	IInteger	R		Returns the timestamp of the multi-buffer download event.
<b>EventBufferPlaybackCompleteData</b>		M	ICategory	R		Category that contains buffer playback complete event features.
<b>EventBufferPlaybackComplete</b>		M	IInteger	R		Returns the buffer playback complete ID that is equal to 36934.
<b>EventBufferPlaybackProgress</b>		M	IInteger	R		Returns buffer playback progress event ID that is equal to 36923.
<b>EventBufferPlaybackComplete Timestamp</b>		M	IInteger	R		Returns the timestamp of the buffer complete event.
<b>EventMultiBufferPlaybackCompleteData</b>		C	ICategory	R		Category that contains multi buffer playback complete event features.
<b>EventMultiBufferPlaybackComplete</b>		C	IInteger	R		Returns the multi-buffer complete playback ID that is equal to 36935.
<b>EventMultiBufferPlaybackComplete Timestamp</b>		C	IInteger	R		Returns the timestamp of the multi-buffer playback event.
<b>EventMediaRecordingProgressData</b>		C	ICategory	R		Category that contains media recording progress.
<b>EventMediaRecordingProgress</b>		C	IInteger	R		Returns the media recording progress 36936.
<b>EventMediaRecordingProgress Timestamp</b>		C	IInteger	R		Returns the timestamp of the media recording event.
<b>PollEventPercentage</b>		C	IInteger	R		Returns percentage complete of the poll status selector value.
<b>PollEventBlockID</b>		C	IInteger	R		Returns value of poll selector.
<b>PollEventTimeStamp</b>		C	IInteger	R		Returns the time of the event selected by the poll selector value.

## 5.8.2 Event Control Custom Features

### 5.8.2.1 Event Selector

This feature selects which event to signal or poll. The trigger event is mandatory and must be provided as a GEV message. If events are not provided as a GEV message they must be available as a PollEventStatus feature.

<b>Name</b>	EventSelector
<b>Level</b>	Mandatory
<b>Interface</b>	IInteger

<b>Unit</b>	Read/Write	
	Event	Event Number
	Acquisition Trigger	36885
	FrameStart	36875
	Media Error	36916
	Over Temperature	36917
	Battery Fail	36918
	Time Sync	36919
	Invalid Time Sync	36920
	AcquisitionEnd	36921
	MediaPlaybackProgress	36922
	BufferPlaybackProgress	36923
	One Remaining Acquisition Storage	36924
	Motion Detected	36925
	Media Full	36926
	<b>EventNextBufferSelected</b>	36927
	Multi-Buffer Download Complete	36928
	BufferRecordingProgress	36929
	Acquisition Arm	36865
	Acquisition Start	36933
	Buffer Download Progress	36931
	Buffer Download Complete	36932
	Buffer Playback Complete	36934
	Multi-Buffer Playback Complete	36935
	Multi-Buffer Recording Complete	36930
	Media Recording Progress	36936
	EventBufferUploadComplete	36937
	EventMultiBufferUploadComplete	36938
	EventUploadProgressEvent	36939

### 5.8.2.2 Event Acquisition Trigger Detected

This feature defines the ID for a trigger event.

<b>Name</b>	EventAcquisitionTrigger
<b>Level</b>	Mandatory
<b>Interface</b>	IInteger
<b>Access</b>	Read
<b>Type Command</b>	EVENT_CMD
<b>Unit</b>	N/A
<b>Values</b>	Req_id = 36885

### 5.8.2.3 FrameStart

This feature defines the ID for the start of acquisition event.

<b>Name</b>	EventFrameStart
-------------	-----------------

<b>Level</b>	Mandatory
<b>Interface</b>	IInteger
<b>Access</b>	Read
<b>Type Command</b>	EVENTDATA_CMD
<b>BufferIndex</b>	IInteger
<b>Unit</b>	N/A
<b>Values</b>	Req_id = 36875 BufferIndex = First four bytes of data

#### 5.8.2.4 Media Error

This feature defines the ID for a media error event.

<b>Name</b>	EventMediaError
<b>Level</b>	Conditional
<b>Interface</b>	IInteger
<b>Access</b>	Read
<b>Type Command</b>	EVENT_CMD
<b>Unit</b>	N/A
<b>Values</b>	Req_id = 36916

#### 5.8.2.5 OverTemperature

This feature defines the ID for an over-temperature event.

<b>Name</b>	EventOverTemperature
<b>Level</b>	Conditional
<b>Interface</b>	IInteger
<b>Access</b>	Read
<b>Type Command</b>	EVENT_CMD
<b>Unit</b>	N/A
<b>Values</b>	Req_id = 36917

#### 5.8.2.6 Battery Fail

This feature defines the ID for a battery fail event.

<b>Name</b>	EventBatteryFail
<b>Level</b>	Conditional
<b>Interface</b>	IInteger
<b>Access</b>	Read
<b>Type Command</b>	EVENT_CMD
<b>Unit</b>	N/A
<b>Values</b>	Req_id = 36918

#### 5.8.2.7 TestMessage

This feature generates a test message at a 1-Hz rate.

<b>Name</b>	TestMessage
-------------	-------------

<b>Level</b>	Mandatory	
<b>Interface</b>	IEnumeration	
<b>Access</b>	N/A	
<b>Unit</b>	N/A	
<b>Values</b>	<b>Description</b>	<b>Value</b>
	None	0
	Buffer Playback Complete	36934
	Multi-Buffer Playback Complete	36935
	Media Recording Progress	36936
	Acquisition Start	36933
	Acquisition Arm	36865
	AcquisitionTrigger	36885
	FrameStart	36875
	Media Error	36916
	Over Temp	36917
	Battery Fail	36918
	Time Sync	36919
	Invalid Time Sync	36920
	AcquisitionEnd	36921
	MediaPlaybackProgress	36922
	BufferPlaybackProgress	36923
	OneRemainingAcquisition Storage	36924
	MotionDetected	36925
	MediaFull	36926
	<b>EventNextBufferSelected</b>	36927
	MultiBufferDownloadComplete	36928
	BufferRecordingProgress	36929
	Buffer Download Progress	36931
	Buffer Download Complete	36932
MultiBufferRecordingComplete	36930	
EventBufferUploadComplete	36936	
EventMultiBufferUploadComplete	36937	

5.8.2.8 Poll Event Status

This feature allows for polling of specific camera states.

<b>Name</b>	PollEventStatus[StatusSelector]
<b>Level</b>	Conditional
<b>Interface</b>	IBoolean
<b>Access</b>	Read
<b>Unit</b>	N/A
<b>Values</b>	State of Status Selector equal to: 36933: Acquisition Start (T/F) 36865: Armed (T/F)

36875: Frame Start (T/F)
36885: Acquisition Trigger (T/F)
36916: Media Error (T/F)
36917: Over Temp (T/F)
36918: Batter Fail (T/F)
36919: Time Sync (T/F)
36920: Invalid Time Sync (T/F)
36921: AcquisitionEnd (T/F)
36924: One Remaining Acquisition Storage (T/F)
36925: Motion Detected (T/F)
36926: Media Full (T/F)
36928: Multi-Buffer download Complete (T/F)
36929: Buffer recording Progress (Percentage)
36922: Media Playback (Progress Percentage)
36931: Buffer Download Progress (Progress Percentage)
36932: Buffer Download Complete (T/F)
36930: Multi-Buffer Download Complete (T/F)
36923: Buffer Playback Progress ( Progress Percentage)
36936: Media Recording Progress (Progress Percentage)
36934: Buffer Playback Complete (T/F)
36935: Multi-Buffer Playback Complete (T/F)

5.8.2.9 Poll Event Percentage

This feature provides percentage complete of the poll status selector value.

<b>Name</b>	PollEventPercentage
<b>Level</b>	Conditional
<b>Interface</b>	IInteger
<b>Access</b>	Read
<b>Unit</b>	Percent
<b>Values</b>	>=0<=100

5.8.2.10 Poll Event Block ID

This feature provides the value of a poll selector.

<b>Name</b>	PollEventBlockID
<b>Level</b>	Conditional
<b>Interface</b>	IInteger
<b>Access</b>	Read
<b>Unit</b>	N/A
<b>Values</b>	>=0

5.8.2.11 Poll Event Timestamp

This feature provides the time of the event selected by the poll selector value.

<b>Name</b>	PollEventTimestamp
<b>Level</b>	Conditional

<b>Interface</b>	IInteger
<b>Access</b>	Read
<b>Unit</b>	Ticks
<b>Values</b>	>0

#### 5.8.2.12 Time Sync

This feature provides an event denoting that the camera is synchronized to an external time source.

<b>Name</b>	EventTimeSync
<b>Level</b>	Conditional
<b>Interface</b>	IInteger
<b>Access</b>	Read
<b>Type Command</b>	EVENT_CMD
<b>Unit</b>	N/A
<b>Values</b>	Req_id = 36919

#### 5.8.2.13 Invalid Time Synchronization

This feature provides an event denoting that the camera has failed to synchronize to an external time source.

<b>Name</b>	EventInvalidTimeSync
<b>Level</b>	Conditional
<b>Interface</b>	IInteger
<b>Access</b>	Read
<b>Type Command</b>	EVENT_CMD
<b>Unit</b>	N/A
<b>Values</b>	Req_id = 36920

#### 5.8.2.14 Event Acquisition Start

This feature provides an event denoting the start of acquisition.

<b>Name</b>	EventAcquisitionStart
<b>Level</b>	Mandatory
<b>Interface</b>	IInteger
<b>Access</b>	Read
<b>Type Command</b>	EVENT_CMD
<b>Unit</b>	N/A
<b>Values</b>	Req_id = 36933

#### 5.8.2.15 Event Acquisition Arm

This feature provides an event denoting that the camera is armed.

<b>Name</b>	EventAcquisitionArm
<b>Level</b>	Mandatory
<b>Interface</b>	IInteger



<b>Access</b>	Read
<b>Type Command</b>	EVENT_CMD
<b>Unit</b>	N/A
<b>Values</b>	Req_id = 36865 BufferIndex = First four bytes of data

## 5.8.2.16 Acquisition End

This feature provides an event denoting that acquisition has completed.

<b>Name</b>	AcquisitionEnd
<b>Level</b>	Conditional
<b>Interface</b>	Integer
<b>Access</b>	Read
<b>Type</b>	EVENTDATA_CMD
<b>BufferIndex</b>	Integer
<b>Unit</b>	N/A
<b>Values</b>	Req_id = 36921 BufferIndex = First four bytes of data

## 5.8.2.17 One Acquisition Remaining

This feature provides an event denoting that only one acquisition remains.

<b>Name</b>	EventOneRemainingAcquisitionStorage
<b>Level</b>	Conditional
<b>Interface</b>	Integer
<b>Access</b>	Read
<b>Type Command</b>	EVENT_CMD
<b>Unit</b>	N/A
<b>Values</b>	Req_id = 36924

## 5.8.2.18 Motion Detected

This feature provides an event denoting that motion has been detected.

<b>Name</b>	EventMotionDetected
<b>Level</b>	Conditional
<b>Interface</b>	Integer
<b>Access</b>	Read
<b>Type Command</b>	EVENT_CMD
<b>Unit</b>	N/A
<b>Values</b>	Req_id = 36925

## 5.8.2.19 Media Full

This feature provides an event denoting that media is full.

<b>Name</b>	EventMediaFull
<b>Level</b>	Conditional

<b>Interface</b>	IInteger
<b>Access</b>	Read
<b>Type Command</b>	EVENT_CMD
<b>Unit</b>	N/A
<b>Values</b>	Req_id = 36926

#### 5.8.2.20 Buffer Download Complete

This feature provides an event denoting that download is complete.

<b>Name</b>	EventBufferDownloadComplete
<b>Level</b>	Mandatory
<b>Interface</b>	IInteger
<b>Access</b>	Read
<b>Type</b>	EVENTDATA_CMD
<b>BufferIndex</b>	IInteger
<b>Unit</b>	N/A
<b>Values</b>	Req_id = 36932 BufferIndex = First four bytes of data

#### 5.8.2.21 Next Buffer Selected

This feature provides an event denoting a change of buffer.

<b>Name</b>	EventNextBufferSelected
<b>Level</b>	Conditional
<b>Interface</b>	IInteger
<b>Access</b>	Read
<b>Type</b>	EVENTDATA_CMD
<b>BufferIndex</b>	IInteger
<b>Unit</b>	N/A
<b>Values</b>	Req_id = 36927 BufferIndex = First four bytes of data

#### 5.8.2.22 Buffer Playback Complete

This feature provides an event denoting that playback from the selected buffer is complete.

<b>Name</b>	EventBufferPlaybackComplete
<b>Level</b>	Conditional
<b>Interface</b>	IInteger
<b>Access</b>	Read
<b>Type</b>	EVENT_CMD
<b>BufferIndex</b>	IInteger
<b>Unit</b>	N/A
<b>Values</b>	Req_id = 36934 BufferIndex = First four bytes of data

## 5.8.2.23 Multi-Buffer Playback Complete

This feature provides an event denoting that playback from all buffers is complete.

<b>Name</b>	EventMultiBufferPlaybackComplete
<b>Level</b>	Conditional
<b>Interface</b>	IInteger
<b>Access</b>	Read
<b>Type</b>	EVENT_CMD
<b>BufferIndex</b>	IInteger
<b>Unit</b>	N/A
<b>Values</b>	Req_id = 36935

## 5.8.2.24 Multi-Buffer Download Complete

This feature provides an event denoting that download from all buffers is complete.

<b>Name</b>	EventMultiBufferDownloadComplete
<b>Level</b>	Conditional
<b>Interface</b>	IInteger
<b>Access</b>	Read
<b>Type</b>	EVENT_CMD
<b>BufferIndex</b>	IInteger
<b>Unit</b>	N/A
<b>Values</b>	Req_id = 36928

## 5.8.2.25 Multi-Buffer Recording Complete

This feature provides an event denoting that recording from all buffers is complete.

<b>Name</b>	EventMultiBufferRecordingComplete
<b>Level</b>	Conditional
<b>Interface</b>	IInteger
<b>Access</b>	Read
<b>Type</b>	EVENT_CMD
<b>BufferIndex</b>	IInteger
<b>Unit</b>	N/A
<b>Values</b>	Req_id = 36930

## 5.8.2.26 Event Buffer Playback Progress

This feature provides an event denoting the percentage of playback completed.

<b>Name</b>	EventBufferPlaybackProgress
<b>Level</b>	Conditional
<b>Interface</b>	IInteger
<b>Access</b>	Read
<b>Type</b>	EVENTDATA_CMD
<b>BufferIndex</b>	IInteger
<b>Percentage</b>	IInteger

<b>Unit</b>	N/A
<b>Values</b>	Req_id = 36923 BufferIndex = First four bytes of data Percentage = Next four bytes of data

 <b>NOTE</b>	An EventTransferProgress may not be generated faster than once per 10% of the transfer progress.
--------------------------------------------------------------------------------------------------	--------------------------------------------------------------------------------------------------

#### 5.8.2.27 Buffer Download Progress

This feature provides an event denoting the percentage of buffer download completed.

<b>Name</b>	BufferDownloadProgress
<b>Level</b>	Mandatory
<b>Interface</b>	IInteger
<b>Access</b>	Read
<b>Type</b>	EVENTDATA_CMD
<b>BufferIndex</b>	IInteger
<b>Percentage</b>	IInteger
<b>Unit</b>	N/A
<b>Values</b>	Req_id = 36931 BufferIndex = First four bytes of data Percentage = Next four bytes of data

#### 5.8.2.28 Media Recording Progress

This feature provides an event denoting the percentage of media recording completed.

<b>Name</b>	EventMediaRecordingProgress
<b>Level</b>	Conditional
<b>Interface</b>	IInteger
<b>Access</b>	Read
<b>Type</b>	EVENTDATA_CMD
<b>BufferIndex</b>	IInteger
<b>Percentage</b>	IInteger
<b>Unit</b>	N/A
<b>Values</b>	Req_id = 36936 BufferIndex = First four bytes of data Percentage = Next four bytes of data

#### 5.8.2.29 Event Buffer Recording Progress

This feature provides an event denoting the percentage of buffer recording completed.

<b>Name</b>	EventBufferRecordingProgress
<b>Level</b>	Conditional
<b>Interface</b>	IInteger
<b>Access</b>	Read

<b>Type</b>	EVENTDATA_CMD
<b>BufferIndex</b>	IInteger
<b>Percentage</b>	IInteger
<b>Unit</b>	N/A
<b>Values</b>	Req_id = 36929 BufferIndex = First four bytes of data Percentage = Next four bytes of data

 <b>NOTE</b>	An EventBufferRecordingProgress may not be generated faster than once per 10% of the recording progress.
--------------------------------------------------------------------------------------------------	----------------------------------------------------------------------------------------------------------

### 5.8.2.30 Event Media Playback

This feature provides an event denoting the percentage of media playback completed.

<b>Name</b>	EventMediaPlayback
<b>Level</b>	Conditional
<b>Interface</b>	IInteger
<b>Access</b>	Read
<b>Type</b>	EVENTDATA_CMD
<b>BufferIndex</b>	IInteger
<b>Percentage</b>	IInteger
<b>Unit</b>	N/A
<b>Values</b>	Req_id = 36922 BufferIndex = First four bytes of data Percentage = Next four bytes of data

 <b>NOTE</b>	An EventMediaPlayback may not be generated faster than once per 10% of the playback progress.
----------------------------------------------------------------------------------------------------	-----------------------------------------------------------------------------------------------

## 5.9 Analog Control

Features in this section describe how to influence the analog features of an image, such as gain, black level, white clip, and gamma.

### 5.9.1 Analog Control Features

Name	GenICam	OSG	Interface	Access	Unit	Description
AnalogControl	O	O	ICategory	R	-	Category that contains the analog control features.
GainSelector	O	O	IEnumeration	R/W	-	Selects which gain is controlled by the various gain features.

Name	GenlCam	OSG	Interface	Access	Unit	Description
Gain[GainSelector]	O	O	IFloat	R/W	-	Controls the selected gain as an absolute physical value.
GainAuto[GainSelector]	O	O	IEnumeration	R/W	-	Sets the automatic gain control mode.
GainAutoBalance	O	O	IEnumeration	R/W	-	Sets the mode for automatic gain balancing between the sensor color channels or taps.
BlackLevelSelector	O	O	IEnumeration	R/W	-	Selects which black level is controlled by the various black level features.
BlackLevel[BlackLevelSelector]	O	O	IFloat	R/W	-	Controls the analog black level as an absolute physical value.
BlackLevelAuto[BlackLevelSelector]	O	O	IEnumeration	R/W	-	Controls the mode for automatic black level adjustment.
BlackLevelAutoBalance	O	O	IEnumeration	R/W	-	Controls the mode for automatic black level balancing between the sensor color channels or taps.
WhiteClipSelector	O	O	IEnumeration	R/W	-	Selects which white clip to control.
WhiteClip[WhiteClipSelector]	O	O	IFloat	R/W	-	Controls the maximal intensity taken by the video signal before being clipped as an absolute physical value.
BalanceRatioSelector	O	O	IEnumeration	R/W	-	Selects which balance ratio to control.
BalanceRatio[BalanceRatioSelector]	O	O	IFloat	R/W	-	Controls ratio of the selected color component to a reference color component.
BalanceWhiteAuto	O	O	IEnumeration	R/W	-	Controls the mode for automatic white balancing between the color channels.
<b>VideoAnalogOut</b>	O	O	IEnumeration	R/W	-	Selects type of analog output signal.
Gamma	O	O	IFloat	R/W	-	Controls the gamma correction of pixel intensity.

### 5.9.2 Analog Custom Features

The Analog Out feature selects the analog video output format of a camera.

<b>Name</b>	VideoAnalogOut
<b>Level</b>	Optional
<b>Interface</b>	IEnumeration
<b>Access</b>	Read
<b>Unit</b>	N/A
<b>Values</b>	0: None 1: RS-170 2: SVideo

## 5.10 Transport Layer Control

This section provides the transport layer control features. The generic features are under the transport layer category and transport layer-specific features are under their respective sub-category. The GEV category lists the features necessary to access GEV bootstrap registers and other information related to the GEV transport medium.

Name	GenICam	OSG	Interface	Access	Unit	Description
TransportLayerControl	R	M	ICategory	R		Category that contains the transport layer control features.
PayloadSize	M	M	IInteger	R	B	Provides the number of bytes transferred for each image or chunk on the stream channel.
GevVersionMajor	R	M	IInteger	R		Major version of the specification.
GevVersionMinor	R	M	IInteger	R		Minor version of the specification.
GevDeviceModeIsBigEndian	O	M	IBoolean	R		Endianness of the device registers.
GevDeviceModeCharacterSet	O	M	IEnumeration	R		Character set used by all the strings of the bootstrap registers.
GevInterfaceSelector	O	C	IInteger	R/W		Selects which physical network interface to control.
GevMACAddress[GevInterfaceSelector]	O	M	IInteger	R		MAC address of the network interface.
GevSupportedOptionSelector	O	M	IEnumeration	R/W		Selects the GEV option to interrogate for existing support.
GevSupportedOption	O	M	IBoolean	R		Returns if the selected GEV option is supported.
GevCurrentIPConfigurationDHCP [GevInterfaceSelector]	O	M	IBoolean	R/W		Controls whether the DHCP IP configuration scheme is activated on the given network interface.
GevCurrentIPAddress [GevInterfaceSelector]	O	M	IInteger	R		Reports the IP address for the given network interface.
GevCurrentSubnetMask [GevInterfaceSelector]	O	M	IInteger	R		Reports the subnet mask of the given interface.
GevCurrentDefaultGateway [GevInterfaceSelector]	O	M	IInteger	R		Reports the default gateway IP address to be used on the given network interface.
GevSecondURL	O	M	IString	R		Indicates the second URL to the XML device description file.
GevNumberOfInterfaces	O	M	IInteger	R		Indicates the number of physical network interfaces supported by this device.
GevPersistentIPAddress [GevInterfaceSelector]	O	M	IInteger	R/W		Controls the persistent IP address for this network interface.
GevPersistentSubnetMask [GevInterfaceSelector]	O	M	IInteger	R/W		Controls the persistent subnet mask associated with the persistent IP address on this network interface.
GevPersistentDefaultGateway [GevInterfaceSelector]	O	M	IInteger	R/W		Controls the persistent default gateway for this network interface.
GevLinkSpeed[GevInterfaceSelector]	O	M	IInteger	R	Mbps	Indicates the speed of transmission negotiated by the given network interface.

Name	GenICam	OSG	Interface	Access	Unit	Description
GevMessageChannelCount	O	M	IInteger	R		Indicates the number of message channels supported by this device.
GevStreamChannelCount	O	M	IInteger	R		Indicates the number of stream channels supported by this device.
GevHeartbeatTimeout	O	M	IInteger	R/W	ms	Controls the current heartbeat timeout in milliseconds.
GevTimestampTickFrequency	O	M	IInteger	R	Hz	Indicates the number of timestamp ticks in 1 second (frequency in Hz).
GevTimestampControlLatch	O	M	ICommand	W		Latches the current timestamp counter into GevTimestampValue.
GevTimestampControlReset	O	M	ICommand	W		Resets the timestamp counter to 0.
GevTimestampValue	O	M	IInteger	R		Returns the latched 64-bit value of the timestamp counter.
GevCCP	O	M	IEnumeration	R/W		Controls the device access privilege of an OBCS controller.
GevStreamChannelSelector	O	M	IInteger	R/W		Selects the stream channel to control.
GevSCPIInterfaceIndex [GevStreamChannelSelector]	O	M	IInteger	R/W		Index of network interface to use.
GevSCPHostPort [GevStreamChannelSelector]	O	M	IInteger	R/W		Controls the port of the selected channel to which a GVSP transmitter must send data stream or the port from which a GVSP receiver may receive data stream.
GevSCPSFireTestPacket [GevStreamChannelSelector]	O	M	IBoolean	R/W		Sends a test packet.
GevSCPSDoNotFragment [GevStreamChannelSelector]	O	M	IBoolean	R/W		The state of this feature is copied into the “do not fragment” bit of IP header of each stream packet.
GevSCPSBigEndian [GevStreamChannelSelector]	O	M	IBoolean	R/W		Endianness of multi-byte pixel data for this stream.
GevSCPSPacketSize [GevStreamChannelSelector]	O	M	IInteger	R/(W)	B	Specifies the stream packet size, in bytes, to send on the selected channel for a GVSP transmitter or specifies the maximum packet size supported by a GVSP receiver.
GevSCPD[GevStreamChannelSelector]	O	M	IInteger	R/W		Controls the delay (in timestamp counter unit) to insert between each packet for this stream channel.
GevMCPHostPort	O	M	IInteger	R/W		Controls the port to which the device must send messages.
GevMCDA	O	M	IInteger	R/W		Controls the destination IP address for the message channel.
GevMCTT	O	M	IInteger	R/W	ms	Provides the transmission timeout value in milliseconds.
GevMCRC	O	M	IInteger	R/W		Controls the number of retransmissions allowed when a message channel message times out.



Name	GenICam	OSG	Interface	Access	Unit	Description
GevSCDA[GevStreamChannelSelector]	O	M	IInteger	R/W		Controls the destination IP address of the selected stream channel to which a GVSP transmitter must send data stream or the destination IP address from which a GVSP receiver may receive data stream.
TLParamsLocked	M	M	IInteger			Used by Transport Layer to prevent critical features changes during acquisition

 <p><b>NOTE</b></p>	<p>Most of these registers are mapped according to GEV standard. In most situations, these registers are directly handled by the framework managing the transport layer and are not directly visible to user (for example, deciding which UDP port number to use for a stream channel).</p> <p>Convention for the GEV section:</p> <p style="padding-left: 40px;">All GEV features start with the “Gev” prefix.</p> <p style="padding-left: 40px;">GEV registers are 32-bit. If a GEV register has multiple fields within this 32-bit, then they are separated in multiple features.</p>
------------------------------------------------------------------------------------------------------	------------------------------------------------------------------------------------------------------------------------------------------------------------------------------------------------------------------------------------------------------------------------------------------------------------------------------------------------------------------------------------------------------------------------------------------------------------------------------------------------------------------------------------------------------------------------------------------

 <p><b>NOTE</b></p>	<p>If the user has configured the camera front end, they can read from the back end which payload size will be transferred for each image. This number covers all kind of data coming with the image (e.g., stamps, etc.) If the user allocates payload size for each buffer he is insured that each frame will fit into his target buffers.</p>
-------------------------------------------------------------------------------------------------------	--------------------------------------------------------------------------------------------------------------------------------------------------------------------------------------------------------------------------------------------------------------------------------------------------------------------------------------------------

### 5.11 User Set Control

These features are for global control of the device settings. It allows loading or saving factory or user-defined settings. Loading the factory default user set guarantees a state where a continuous acquisition can be started using only the mandatory features.

Name	GenICam	OSG	Interface	Access	Unit	Description
UserSetControl	R	M	ICategory	R	-	Category that contains the user set control features.
UserSetSelector	R	M	IEnumeration	R/W	-	Selects the feature user set to load, save, or configure.
UserSetLoad[UserSetSelector]	R	M	ICommand	(R)/W	-	Loads the user set specified by UserSetSelector to the device and makes it active.
UsersetSave[UserSetSelector]	R	O	ICommand	(R)/W	-	Save the user set specified by UserSetSelector to the non-volatile memory of the device.
UserSetDefaultSelector	O	M	IEnumeration	R/W	-	Selects the feature user set to load and make active when the device is reset.

## 5.12 Time Source Control

An OSG- and ANCS-compliant camera derives time from external IRIG time inputs, from IEEE-1588 Precision Time Protocol IAW the GEV standard, or from a free-running clock. Requirements for IRIG AM or DC code signals shall be part of an on-board camera specification and are not defined in this standard. The free-running clock requirements shall be part of an on-board camera specification and are not defined in this standard.

### 5.12.1 Time Source Control Features

Name	GenCam	OSG	Interface	Access	Unit	Description
<b>TimeSourceControl</b>		M	ICategory	R		Category that contains the time source settings.
<b>TimeSourceSelect</b>		M	IEnumeration	R/W		Selects the type of external time source that is to be used.
<b>TimeSourceStatus</b>		M	IEnumeration	R		Gets the lock status of the external time source.
<b>TimeOverlay</b>		O	IEnumeration	R/W		Selects if character overlay display method
<b>TimeOverlayXLoc</b>		O	IInteger	R/W		Position on X axis of time overlay
<b>TimeOverlayYLoc</b>		O	IInteger	R/W		Position on Y axis of time overlay
<b>TimeOverlayEvent</b>		O	IBoolean	R/W		Selects if a trigger event causes time display to change.
<b>TimeOverlayFmt</b>		O	IEnumeration	R/W		Selects the characters to display

### 5.12.2 Time Source Control Custom Features

#### 5.12.2.1 Time Source Control Category

This feature is the category for the time source control features.

<b>Name</b>	TimeSourceControl
<b>Level</b>	Mandatory
<b>Interface</b>	ICategory
<b>Access</b>	Read
<b>Unit</b>	N/A
<b>Values</b>	N/A

#### 5.12.2.2 Time Source Select Feature

This feature selects the time source.

<b>Name</b>	TimeSourceSelect
<b>Level</b>	Mandatory
<b>Interface</b>	IEnumeration
<b>Access</b>	Read/Write
<b>Unit</b>	N/A
<b>Values</b>	0: FREERUN 1: IRIGAAC 2: IRIGADC 3: IRIGBAC

	4: IRIGBDC 5: IRIGGAC 6: IRIGGDC 7: IEEE1588
--	-------------------------------------------------------

### 5.12.2.3 Time Source Status Feature

This feature identifies the lock status of the time source.

<b>Name</b>	TimeSourceStatus
<b>Level</b>	Mandatory
<b>Interface</b>	IEnumeration
<b>Access</b>	Read
<b>Unit</b>	N/A
<b>Values</b>	0: UnLocked 1: Locked

### 5.12.2.4 Character Overlay Selection

<b>Name</b>	TimeOverlay
<b>Level</b>	Optional
<b>Interface</b>	IEnumeration
<b>Access</b>	Read
<b>Unit</b>	N/A
<b>Values</b>	0: None 1: blackOntransparent 2: whiteOntransparent 3: blackOnwhite 4:whiteOnblack

### 5.12.2.5 Time Overlay X Location

This feature identifies the horizontal (X) location of the overlaid time on the image.

<b>Name</b>	TimeOverlayXLoc
<b>Level</b>	Optional
<b>Interface</b>	IInteger
<b>Access</b>	Read
<b>Unit</b>	N/A
<b>Values</b>	> 0

### 5.12.2.6 Time Overlay Y Location

This feature identifies the vertical (Y) location of the overlaid time on the image.

<b>Name</b>	TimeOverlayYLoc
<b>Level</b>	Optional
<b>Interface</b>	IInteger
<b>Access</b>	Read
<b>Unit</b>	N/A

<b>Values</b>	> 0
---------------	-----

5.12.2.7 Time Overlay Event

The normal character color (white) and the normal background color (black) shall reverse to black characters on white background for trigger event occurrence.

<b>Name</b>	TimeOverlayEvent
<b>Level</b>	Optional
<b>Interface</b>	IBoolean
<b>Access</b>	Read
<b>Unit</b>	N/A
<b>Values</b>	True = Event Enabled False = Event disabled

5.12.2.8 Overlay Format

The time overlay may be selected to exclude day and microsecond fields.

<b>Name</b>	TimeOverlayFmt
<b>Level</b>	Optional
<b>Interface</b>	IEnumeration
<b>Access</b>	Read
<b>Unit</b>	N/A
<b>Values</b>	0= DDD:HH:MM:SS:TTT:UUU 1= HH:MM:SS:TTT:UUU 2= HH:MM:SS:TTT

5.13 File Access

Data that has been captured and stored to an OSG- and ANCS-compliant camera’s local or removable memory may optionally be transferred to SCP1 for the purposes of post-acquisition review.

5.13.1 File Access Features

Name	GenCam	OSG	Interface	Access	Unit	Description
FileAccessControl	R	C	ICategory	R		Category that contains the FileAccess control features.
FileSelector	R	C	IEnumeration	R/(W)		Selects the target file in the device.
FileAccessBuffer	R	C	IRegister	R/(W)		Defines the intermediate access buffer that allows the exchange of data between the device file storage and a GEV receiver.
FileOperationStatus [FileSelector]	R	C	IEnumeration	R		Represents the file operation execution status.
FileSize[FileSelector]	R	C	IInteger	R		Represents the size of the selected file in bytes.
<i>Numfiles</i>		C	<i>IInteger</i>	<i>R</i>		<i>Represents number of files in the on-board camera.</i>

### 5.13.2 File Access Control Custom Features

The NumFiles feature provides the number of files residing in the media of the camera.

<b>Name</b>	NumFiles
<b>Level</b>	Conditional
<b>Interface</b>	Integer
<b>Access</b>	Read
<b>Unit</b>	N/A
<b>Values</b>	$\geq 0$

## CHAPTER 6

### GigE Vision Control Protocol

A control channel is required to send commands from a GEV primary application to a GEV device and to receive the corresponding acknowledge packet (when one is requested). The GVCP defines two types of control channels: a primary and secondary control. The primary control channel is created by a GEV primary application. A GEV primary application is the one that is allowed to write to the device registers. Only one GEV primary application is allowed for a device. The secondary control channel is created by any GEV secondary application. A GEV secondary application can only read from the device registers (they cannot write into them).

A control channel shall be instantiated by a GEV primary application before stream or message channels can be created. The packet flow sequence on a control channel is as follows.

- (1) The GEV primary application sends a command packet.
- (2) The on-board camera receives the command packet.
- (3) The on-board camera executes the command.
- (4) The on-board camera sends the acknowledge packet (if acknowledge is requested).
- (5) The GEV primary application receives the acknowledge packet (if acknowledge is requested).

In an ANCS-compliant environment, power to the many devices may be from different sources. It is thus critical that a mechanism be provided to detect when a device is not online. The GVCP provides for a recovery mechanism whereby if one of the two participants (GEV primary application or device) is abruptly detached a method of recovery is provided. This is achieved using a heartbeat sequence. The GEV primary application must periodically run this sequence if there is no activity on the control channel. The rate at which the sequence must be run is user-programmable. The default value is once per second and it is programmable in the GEV primary application. The device shall provide a bootstrap register to control the heartbeat timeout and is a requirement of this standard.

#### 6.1 Control Channel Command and Acknowledge Values

[Table 3](#) lists the numerical value associated with each message defined in the GEV standard and required by this standard.

<b>Table 3. Message Numerical Values</b>			
<b>Message</b>	<b>Support</b>	<b>Channel</b>	<b>Value</b>
<i>Discovery Protocol Control</i>			
DISCOVERY_CMD	M	Control	0x0002
DISCOVERY_ACK	M	Control	0x0003
FORCEIP_CMD	M	Control	0x0004
FORCEIP_ACK	M	Control	0x0005

<b>Table 3. Message Numerical Values</b>			
<b>Message</b>	<b>Support</b>	<b>Channel</b>	<b>Value</b>
<i>Streaming Protocol Control</i>			
PACKETRESEND_CMD	M	Control	0x0040
<i>Device Memory Access</i>			
READREG_CMD	M	Control	0x0080
READREG_ACK	M	Control	0x0081
WRITEREG_CMD	M	Control	0x0082
WRITEREG_ACK	M	Control	0x0083
READMEM_CMD	M	Control	0x0084
READMEM_ACK	M	Control	0x0085
WRITEMEM_CMD	M	Control	0x0086
WRITEMEM_ACK	M	Control	0x0087
PENDING_ACK	M	Control	0x0089
<i>Asynchronous Events</i>			
EVENT_CMD	M	Message	0x00C0
EVENT_ACK	M	Message	0x00C1
EVENT_CMD	M	Message	0x00C2
EVENTDATA_ACK	M	Message	0x00C3
<i>Miscellaneous</i>			
ACTION_CMD	M	Control	0x0100
ACTION_ACK	M	Control	0x0101

## 6.2 Message Channel

A message channel allows a device to send asynchronous messages to the GEV primary application. For example, an ANCS-compliant camera may want to signal that a trigger has been detected or percentage of data transfer completed. A message channel is very similar to a control channel, but requests are emitted in the opposite direction. The device always initiates transactions on the message channel. Therefore, the message channel headers are identical to the control channel headers. Support of a message channel is mandatory by this standard.

The packet flow sequence on a message channel is:

- (1) The on-board camera sends a message packet.
- (2) The GEV primary application receives the message packet.
- (3) The GEV primary application process the message.
- (4) The GEV primary application sends the acknowledge packet (if acknowledge is requested).
- (5) The on-board camera receives the acknowledge packet (if acknowledge is requested).

<b>NOTE</b> 	A requirement of this standard is that the req_id field on the message channel shall increment from one message to the next (except for retransmission). When req_id wraps around to 0, then its value must be set to 1 (0 is invalid for req_id). Therefore, req_id 65535 gets incremented to 1.
--------------------------------------------------------------------------------------------------	---------------------------------------------------------------------------------------------------------------------------------------------------------------------------------------------------------------------------------------------------------------------------------------------------

<b>NOTE</b> 	A requirement of this standard is for a camera to use any dynamic port number as the UDP source port for the message channel.
--------------------------------------------------------------------------------------------------	-------------------------------------------------------------------------------------------------------------------------------

<b>NOTE</b> 	A requirement of this standard is if a camera is transmitting a packet while its message channel is being closed, then this message <b>MUST</b> be completely transmitted.
--------------------------------------------------------------------------------------------------	----------------------------------------------------------------------------------------------------------------------------------------------------------------------------

### 6.2.1 Message Channel Bootstrap Registers

A requirement is for on-board cameras to provide the following bootstrap registers.

- Message Channel Port Register
- Message Channel Destination Address Register (MCDA)
- Message Channel Transmission Timeout Register (MCTT)
- Message Channel Retry Count Register (MCRC)
- Message Channel Source Port Register (MCSP)



This page intentionally left blank.

## CHAPTER 7

### Streaming Protocol

The GVSP defines a mechanism for a GVSP transmitter (i.e., camera) to send image data, image status, and other data to a GVSP receiver. This standard requires payloads streamed out of a camera to be of an image type as defined in the GEV standard. The stream using the image payload type shall output data in raster-scan format. It is up to the GVSP receiver to reconstruct the image. The tap configuration information and the way they are associated to stream channels are specified in the XML device description file. Packet payload and definitions are IAW the GVSP.

There are several modes of acquisition as defined in Section 5.3 of this standard. Once images have been captured to volatile memory they may be transferred to a network destination or transferred to acquisition storage memory local to the camera.

#### 7.1 Continuous Live Streaming

The SCP0 channel shall be utilized to preview the object of interest prior to the event and also serves to adjust the camera settings (i.e., exposure, ROI, etc). In operation the images from an ANCS-compliant camera(s) are previewed at an on-board receiver or possibly transmitted to an off-board receiver. Minimum latency requirement is specified by the end user. The frame rate is user-specified. As a requirement of this standard SCP0 is designated as the Live Preview channel.

#### 7.2 Continuous Memory Acquisition

Frames are continuously transferred from a GEV transmitter to a GEV receiver. If the volatile memory or media are involved in the transfer, the transfer continues in a loop from the start of the buffer after the end of the buffer is reached. Transfer is accomplished on SCP1.

#### 7.3 Multi-Frame Acquisition

The number of frames acquired in this mode is defined by the value of the AcquisitionFrameRate feature. If this value is 0 and the volatile memory or media is involved in the transfer, the acquisition will stop automatically when the end of the buffer is reached. Data that has been acquired (i.e., captured) may be transferred from an ANCS-compliant camera's volatile memory to storage media. Multi-frame capture is accomplished from either a hardware or software trigger to the ANCS-compliant camera. The trigger capture point may be preceded by (n) number of frames indicated by the pre-trigger custom feature. Pre-trigger is required so that images may be captured leading up to the trigger event.

Once the capture has been completed, the image frames shall be downloaded to local storage on an on-board camera or transferred over the network employing the GVSP protocol to a GEV receiver. As a requirement of this standard acquisition transfer of stored data from the camera shall be accomplished utilizing SCP1.

#### 7.4 Acquisition Data Storage

[Figure 11](#) illustrates the layout of the acquisition data storage directory file.

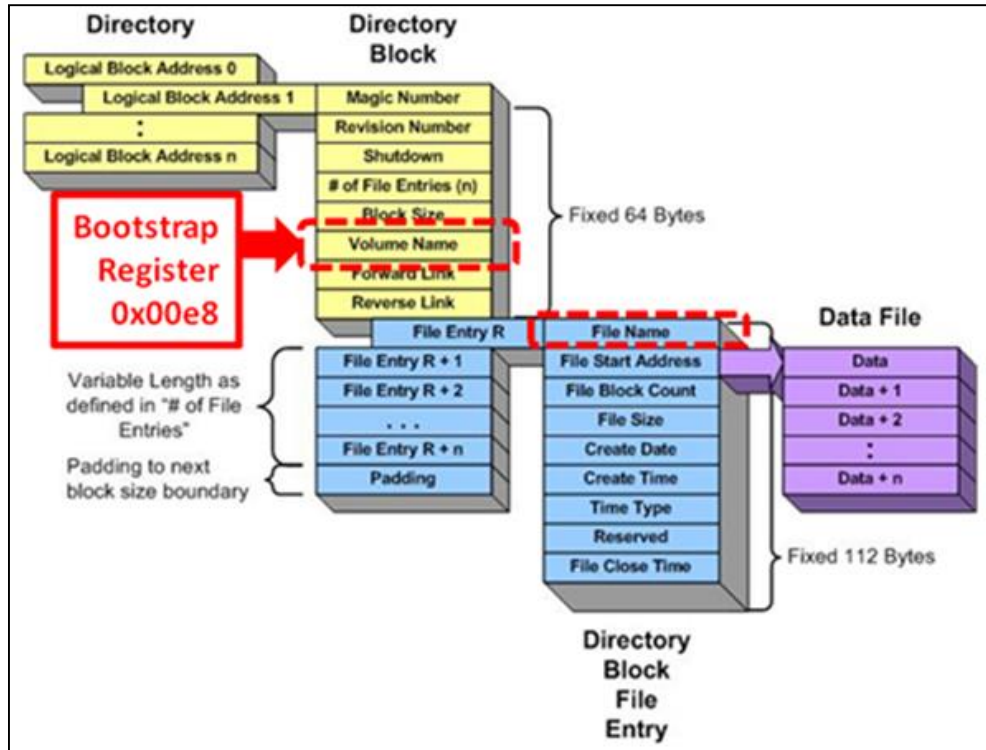

Figure 11. Acquisition Data Storage Directory/File

- For Type III and IV ANCS-compliant cameras IAW Section 3.2.3 and Section 3.2.4 providing acquisition data storage to nonvolatile local or removable memory it shall be encapsulated and formatted IAW the IRIG 106-13 Chapter 10 Digital Recording Standard. The directory/file structure shall be IAW Section 10.5 of the Chapter 10 standard and the packet structure/format shall be IAW Section 10.6 of the Chapter 10 standard.
- A requirement is for the volume name to match the bootstrap 0x00e8 value entry. The file names shall be composed of the preamble ACQ and the numerical value of the file number (i.e., ACQ01).
- Two modes of data recording storage operation shall be provided for OSG-compliant ANCS Type III and IV cameras. The first mode (single file acquisition) closes the recording file after each acquisition. The second mode records multiple acquisitions to the same file.
- To avoid loss of acquisition storage data packets shall be committed to the recording stream within one second of packet generation IAW IRIG 106-13 Chapter 10 Section 10.6.

#### 7.4.1 Timing Source and Synchronization

Acquisition data recording timing accuracy in respect to the reference trigger input shall be equal to or less than that 1 microsecond.

#### 7.4.2 Relative Time Counter

A 10-MHZ relative time counter (RTC) shall be provided IAW IRIG 106-13 Chapter 10 Section 10.6. The RTC shall be slaved to the reference free-running clock, IRIG time code, or IEEE-1588 Precision Time Protocol source.

#### 7.4.3 Acquisition Data Storage - Setup Record Packets

- a. Recorder and input channel definitions shall be provided in the IRIG 106-13 Chapter 10 setup record (first packet in any recording) and IRIG 106-13 Chapter 9.<sup>5</sup> The dynamic image data information shall be derived from bootstrap and GenICam attributes.
- b. If changes are made to the initial dynamic imagery settings IAW IRIG 106-13 Chapter 10 Subsection 10.6.7.2, a new Computer Generated Data, Format 1 Setup Record packet shall be created and inserted in the recording prior to any Format 2 image packets to which the new settings are applied. These changes shall be noted as a Setup Record Configuration Change in the Computer Generated Data, Format 1 Setup Record channel-specific data word bit 8.

#### 7.4.4 Acquisition Data Storage - Time Packets

Time packets shall be included within the recording IAW IRIG 106-13 Chapter 10 Subsections 10.5.1 and 10.6.3. An OSG-compliant on-board Type III and IV camera may synchronize to a free-running clock, to external IRIG-A/B/G time code, or IEEE-1588 Precision Time Protocol source. This does not mandate the input timing source; however as a minimum it is recommended that an external IRIG signal be provided.

#### 7.4.5 Acquisition Data Storage - Index/Event Packets

- a. Index and event packets shall be included within the recording IAW IRIG 106-13 Chapter 10 Subsections 10.6.7.3 and 10.6.7.4.
- b. A root packet shall be the last packet in a recording IAW IRIG 106-13 Chapter 10 Subsection 10.6.7.4.a at a minimum and IAW IRIG 106-13 Chapter 10 Subsection 10.6.7.4 indexes shall be created for time packets and event packets.
- c. The following minimum events shall be defined in the setup record and captured by an OSG-compliant on-board Type III and IV camera.
  - (1) Acquisition Arm Event: This event shall be captured from the camera external Acquisition Arm command. The event entry RTC time stamp shall be based upon when the camera transitions to the arm state. This event marks the camera arm point.

EVENT ID (R-x\EV\ID-1) = "ACQ\_ARM".

DESCRIPTION (R-x\EV\D-1) = "Acquisition Arm"

EVENT TYPE (R-x\EV\T-1) = External - 'E'

---

<sup>5</sup> Range Commanders Council. Telemetry Standards. Chapter 9, Telemetry Attributes Transfer Standard. IRIG 106-13. June 2013. May be superseded by update. Available at [http://www.wsmr.army.mil/RCCsite/Documents/106%20Previous%20Versions/106-13\\_Telemetry\\_Standards/Chapter%209.pdf](http://www.wsmr.army.mil/RCCsite/Documents/106%20Previous%20Versions/106-13_Telemetry_Standards/Chapter%209.pdf).

EVENT PRIORITY (R-x\EV\P-1) = Priority 5 - '5'

- (2) Acquisition Start Event: This event shall be captured from the camera external Acquisition Start command. The event entry RTC time stamp shall be based upon when the camera transitions to the start state. This event marks the camera trigger point of image capture (acquisition).

EVENT ID (R-x\EV\ID-2) = "ACQ\_START".

DESCRIPTION (R-x\EV\D-2) = "Acquisition Start"

EVENT TYPE (R-x\EV\T-2) = External - 'E'

EVENT PRIORITY (R-x\EV\P-2) = Priority 5 - '5'

- (3) Fault Event: This event shall be captured from the camera when a fault is detected. The event entry RTC time stamp shall be based upon when the fault was detected.

EVENT ID (R-x\EV\ID-3) = "FAULT".

DESCRIPTION (R-x\EV\D-3) = "Fault"

EVENT TYPE (R-x\EV\T-3) = Internal - 'I'

EVENT PRIORITY (R-x\EV\P-3) = Priority 5 - '5'

#### 7.4.6 Acquisition Data Storage - Dynamic Image Packets

- a. Camera sensor acquisition data shall be encapsulated in Dynamic Imagery Packet Format 2 as defined in the IRIG 106-13 Chapter 10 Standard Subsection 10.6.11.3. Accordingly an image packet may contain one or more fixed-length segments of a partial dynamic image, one complete dynamic image, or multiple complete dynamic images.
- b. Dynamic image data definitions shall be provided in the IRIG 106-13 Chapter 10 setup record (first packet in any recording). The dynamic image data information shall be derived from bootstrap and GenICam attributes.
- c. The Dynamic Image intra-packet header (IPH) (Time Stamp/Data) shall be provided IAW IRIG 106-13 Chapter 10 Subsection 10.6.11.3. The IPH time shall be coincident with the time of acquisition by the sensor. The accuracy requirement is equal to or less than 1 microsecond. It is recognized that time stamps contain a delay period from sensor/camera image capture to image packetization. The packet header time correlates to the time the packet was committed to the stream, which IAW IRIG 106-13 Chapter 10 Section 10.6 shall be within one second.
- d. The image capture time is defined by the IPH TIME value, which corresponds to the relative time counter or absolute time when the image was captured by the sensor/camera. Image Capture Time mode time stamps are considered not to contain a delay period from sensor/camera image capture to image packetization.
- e. The IPH represents the time that the image was captured and should be coincident with the trigger input. The packet header RTC represents the time that the image was first written into the packet (first bit).

## CHAPTER 8

### User Test Cases

#### 8.1 Live Preview/Local Storage/Multiple Buffers/Buffer Automation

For this test case, a user application must configure the camera to auto-arm and preset configuration settings. The user application will define the number of buffers required. The camera's configuration settings must ensure the camera shows a suitable live image when acquisition control is turned on without any further configuration. The ANCS-compliant camera will be configured with pretrigger frames in a multi-frame acquisition mode.

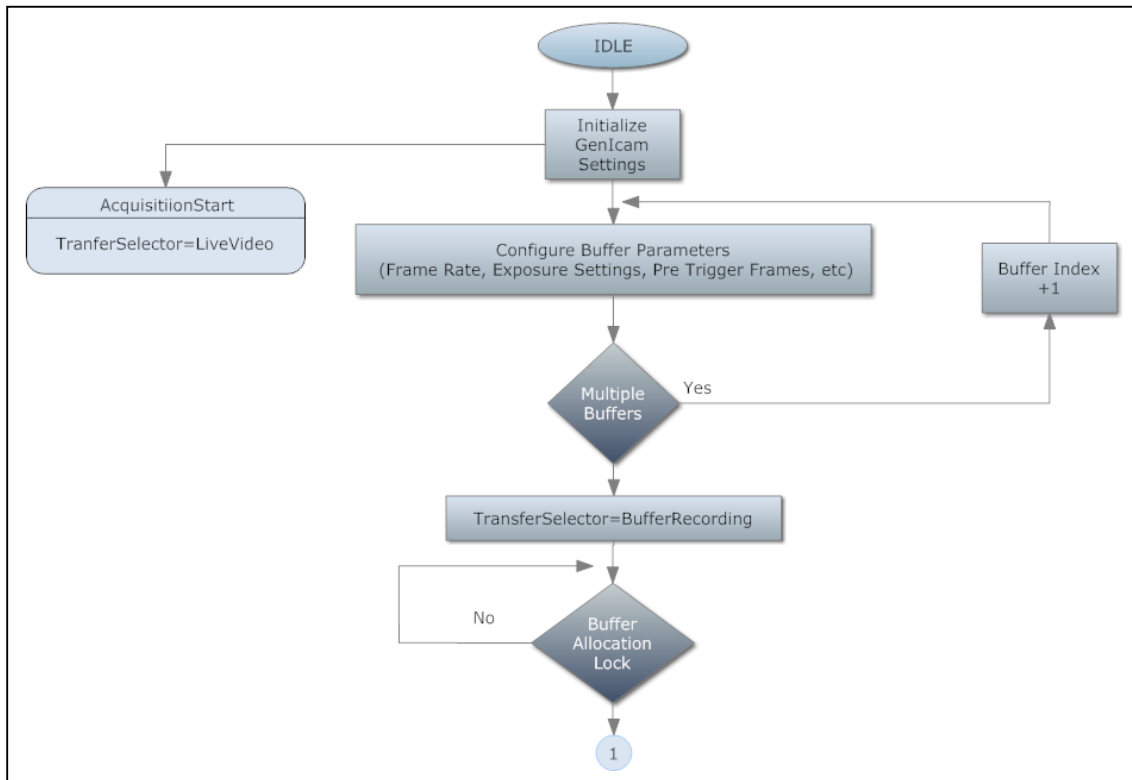

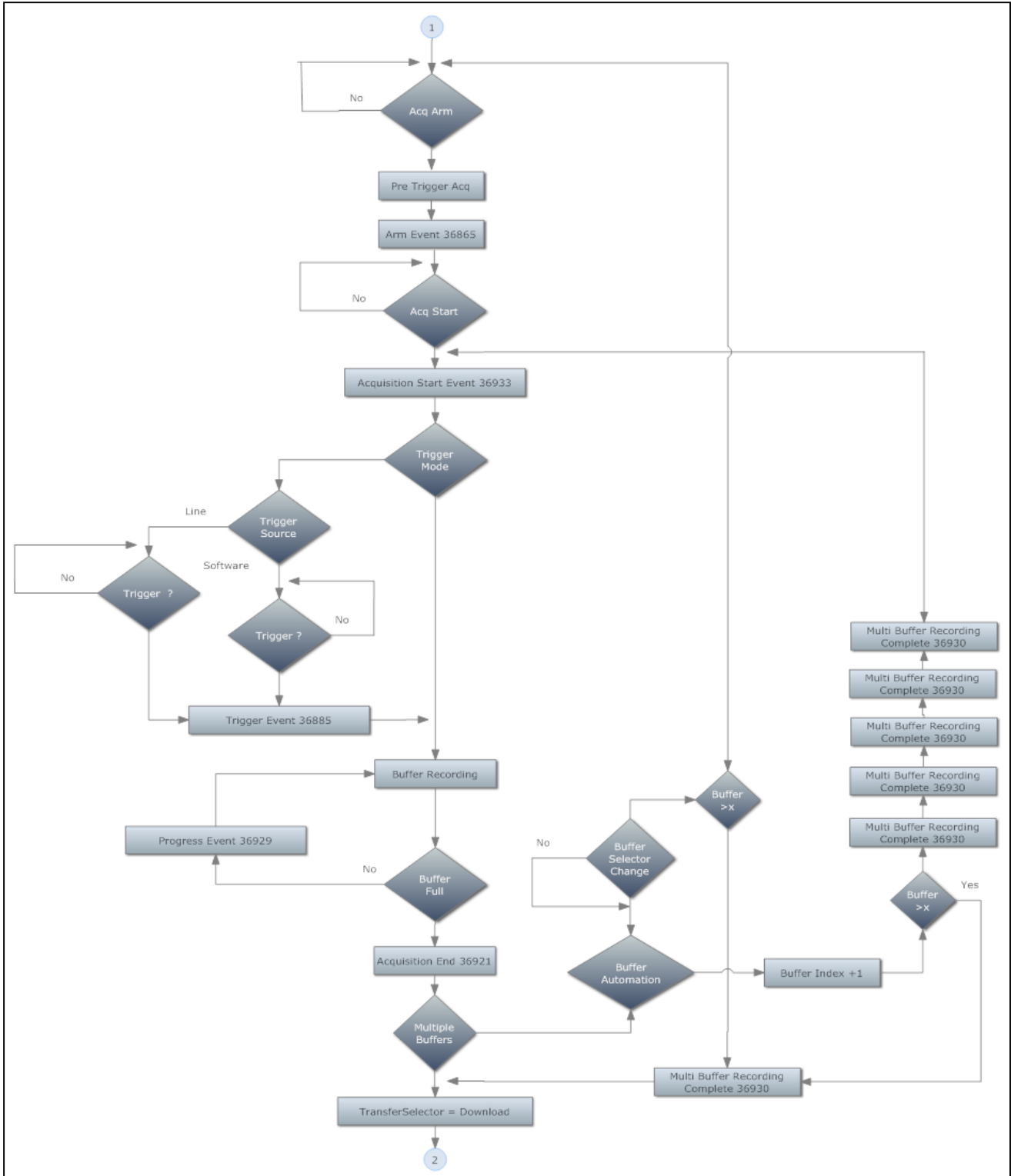

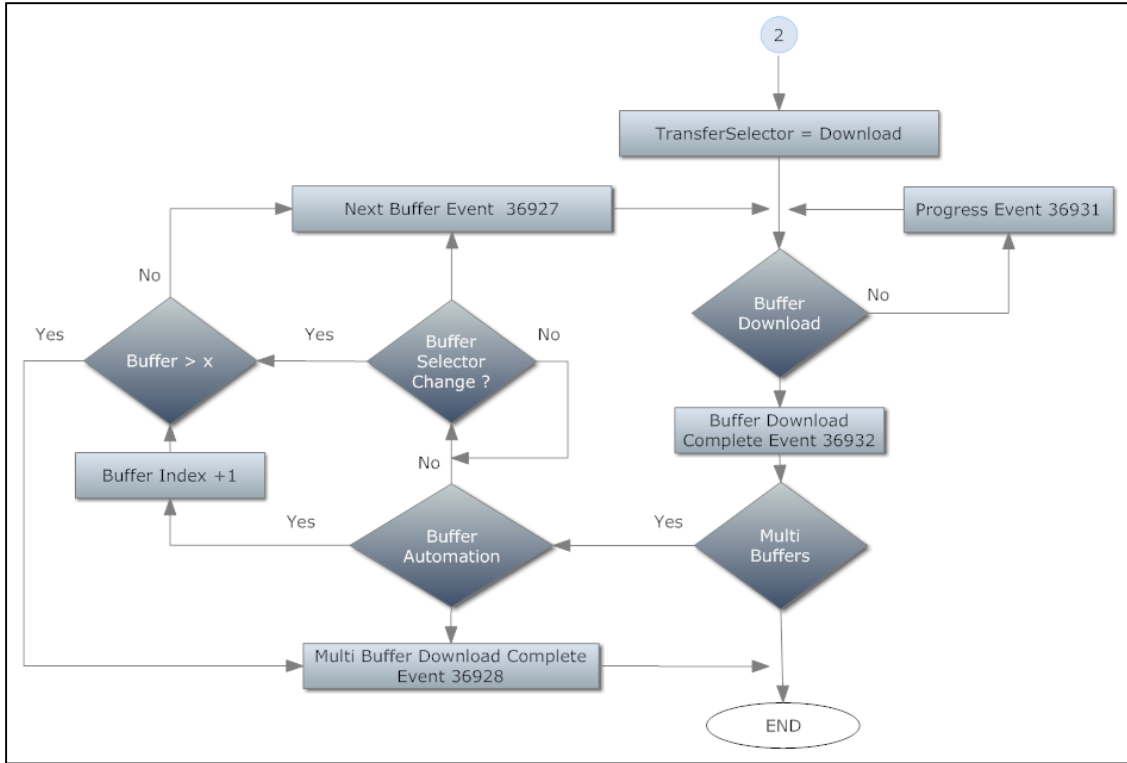

## 8.2 Live Preview/Buffer Recording/No Local Storage

For this test case, a user application must configure the camera to auto-arm and preset configuration settings. The user application will define the number of buffers required. The camera's configuration settings must ensure the camera shows a suitable live image when acquisition control is turned on without any further configuration. The ANCS-compliant camera will be configured with pretrigger frames in a multi-frame acquisition mode. Live video will be provided on SCP0. After all buffers have been acquired, data in buffers will be played back to the host application on SCP1.



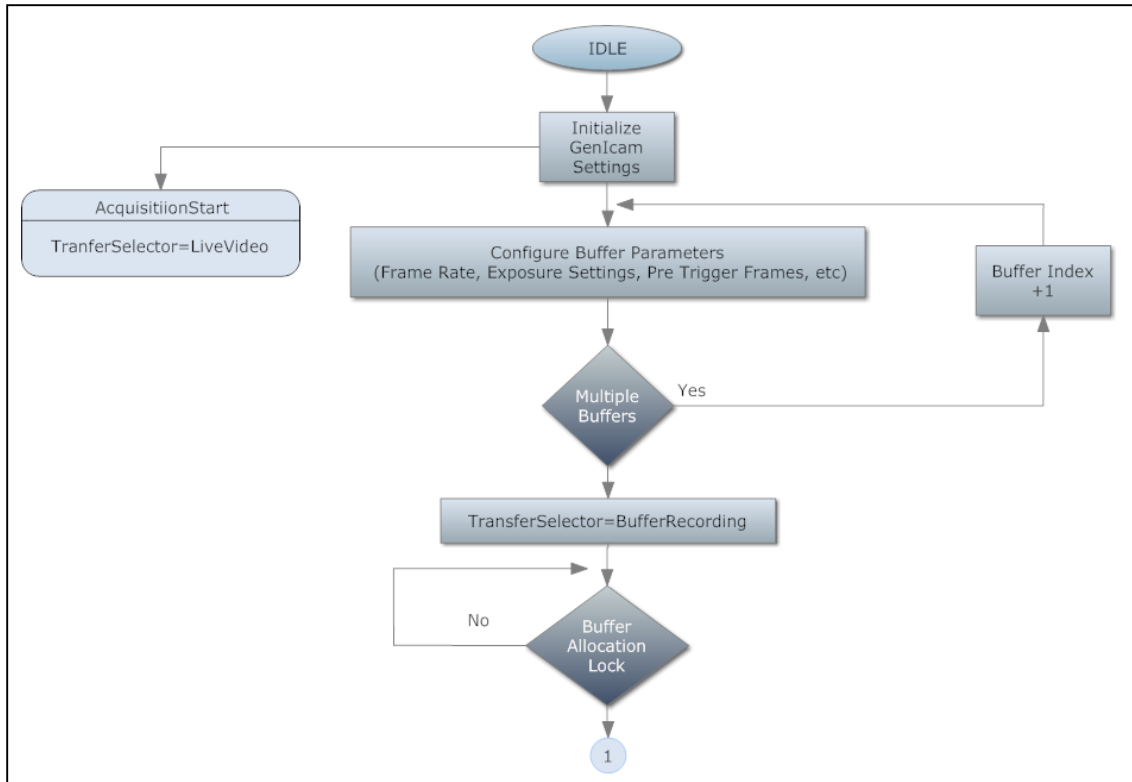

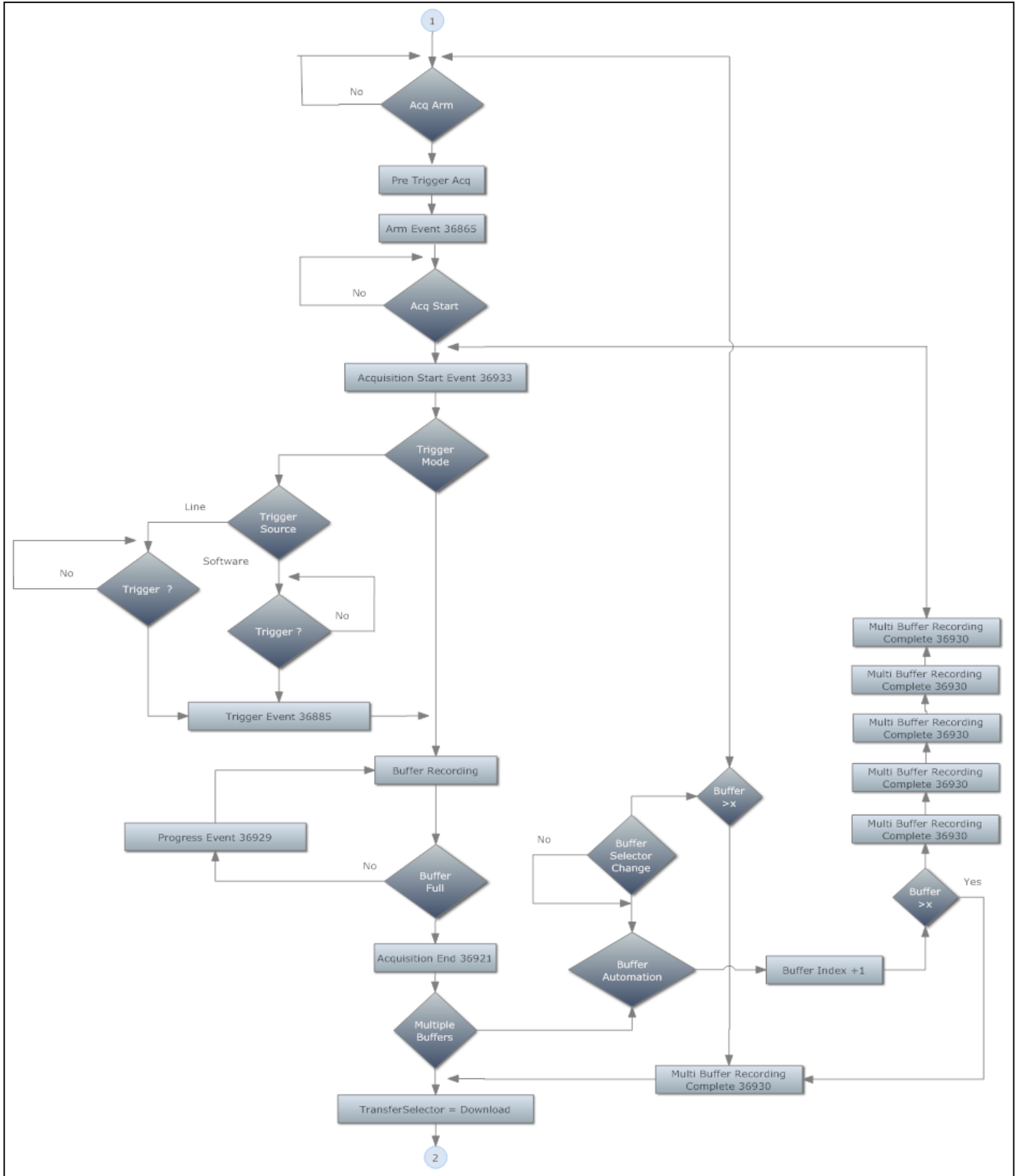

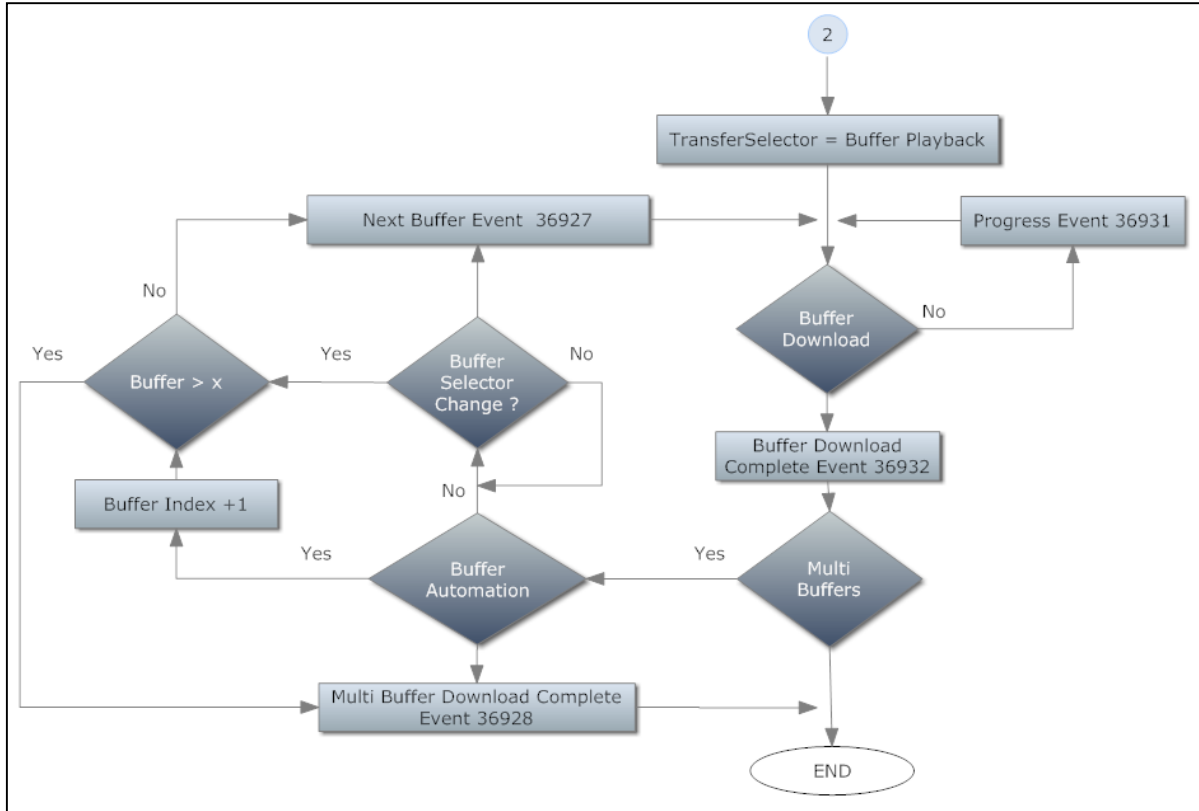

### 8.3 Live Preview/Local Storage Recording

For this test case, a user application must configure the camera to auto-arm and preset configuration settings. The camera's configuration settings must ensure the camera shows a suitable live image when acquisition control is turned on without any further configuration. The ANCS-compliant camera will be configured with pretrigger frames in a multi-frame acquisition mode. Live video will be provided on SCP0. Upon trigger, data will be captured directly to local media.

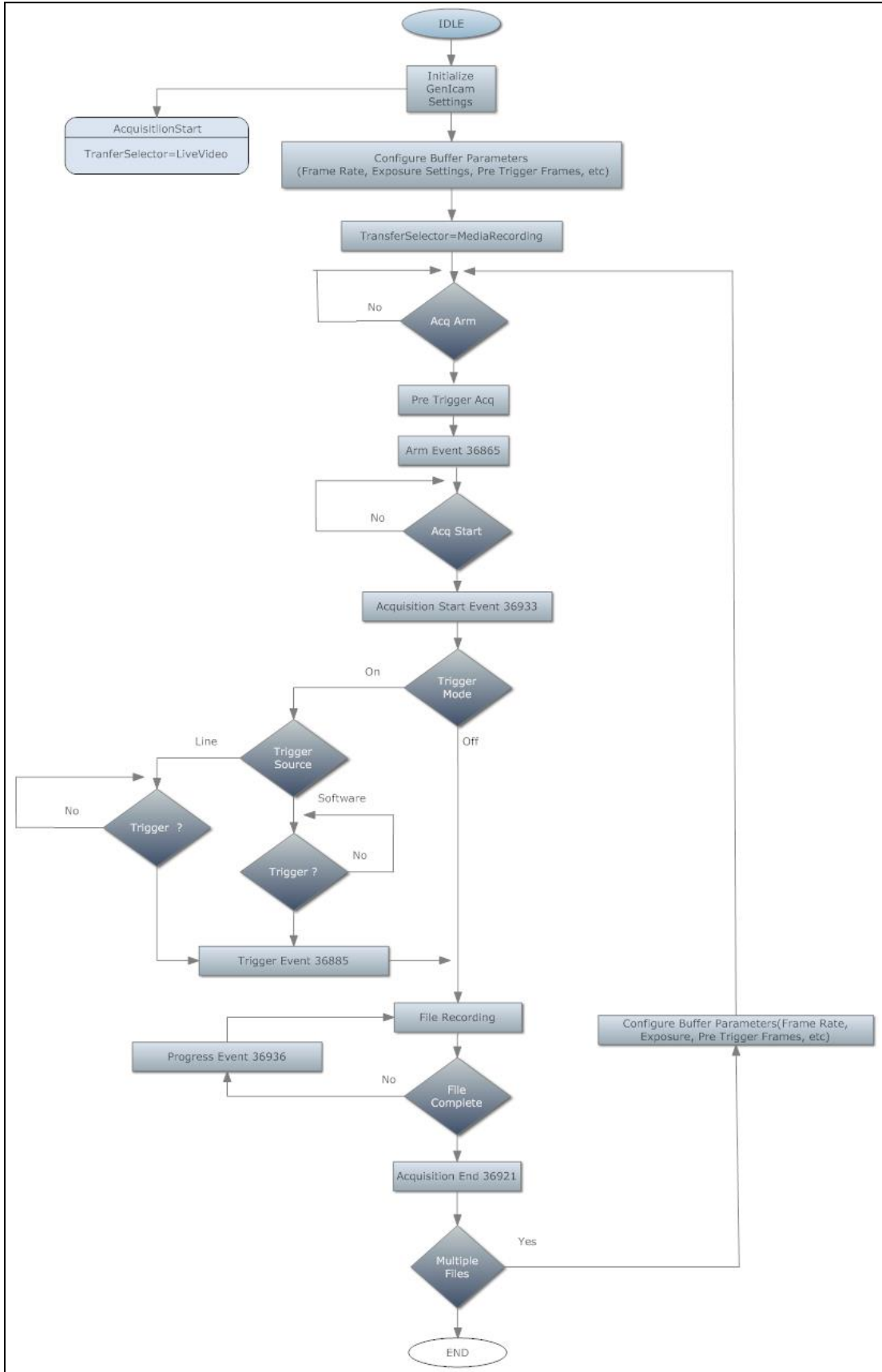

This page intentionally left blank.

## APPENDIX A

### Definitions

Acquisition: Image composed of one or more frames based on a command, event, external hardware trigger, or scheduled time.

Acquisition Start: Starts image acquisition in the specified mode.

Acquisition Stop: Stops image acquisition in the specified mode.

Acquisition Transfer: The data flow that transfers acquired IRIG 106 Chapter 10 formatted data from camera storage memory to a network destination device.

Bootstrap Registers: Allows access and configuration of a device (camera) and located at fixed address as specified by the GEV standard.

Buffer Recording: The process of transferring image data from the camera sensor to the buffer.

Buffers: Segment memory into acquisition regions.

BufferDownload: The process of transferring data from the buffer to local media residing in the ANCS-compliant camera.

BufferPlayback: The process of transferring data from the buffer to a destination on the network.

BufferUpload: The process of moving data from the ANCS-compliant camera's local media to its local buffer.

Conditional Requirement: Feature that SHOULD be supported IF another feature is present.

Device: GigE Vision-compliant controllable device. Typically a camera but can also be of another nature, such as a primary application running on a host.

Device Discovery: Device discovery consists of the sequence of events required for a GigE Vision-controllable device to obtain a valid IP using standard IP protocols.

Event Generator: A device generating event messages according the GigE Vision specification.

Event Receiver: A device receiving and capable of interpreting event messages according to the GigE Vision specification.

Frames: A frame is defined as the data capture of width of pixels by height lines over an exposure period.

GenICam: A standard for exposing camera control attributes as part of the GEV standard.

GigE Vision (GEV): A camera interface standard developed based on Gigabit and 10-Gigabit Ethernet communication protocol.

GigE Vision Control Protocol (GVCP): Defines how to specify stream channels and control/configure compliant devices.

GigE Vision Streaming Protocol (GVSP): Defines how images are packetized and provides a mechanism for cameras to send image data and other information to host computers.

GVSP Receiver: A device receiving and capable of de-encapsulating a stream of data according to the GVSP.

GVSP Transmitter: A device producing a stream of data according to the GVSP.

Live Preview Data: Continuous frames that are captured and output as uncompressed image data over the Ethernet interface.

MediaPlayback: The process of moving data from the ANCS-compliant camera's local media to a destination on the network.

MediaRecording: The process of transferring image data from the camera sensor to nonvolatile media residing in the ANCS-compliant camera.

OSG Data Transmission Mode: Standard transmission mode is required by this standard; a data leader, data payload, and data trailer are separated in different packets.

Persistent IP: A persistent IP address is hard-coded in non-volatile memory of the device. It is re-used by the device on power-cycle when Persistent IP is enabled.

Port: A port is an Ethernet interface.

Pre-Trigger Frames: Number of frames that precede the acquisition start point and can be included as part of the data capture.

Primary Application: Application having exclusive or control access (read/write) to the device.

Primary Application Switchover: The condition under which another application is trying to take control over a device that is under the control of a primary application that was granted control access with switchover enabled.

Pull Mode: Pull mode is an operational mode where the rate at which data is received and processed is determined and controlled by the processing algorithm.

Push Mode: Push mode is an operational mode where the rate at which the data, usually live, is received and processed is not determined or controllable by the processing algorithm.

Secondary Application: Application having monitoring access (read-only) to the device.

Standard GVCP Port: UDP port used on a device to receive GVCP commands.

Static IP: A static IP address is set by the application into the device's volatile memory.

Transfer: The process of moving data from the ANCS-compliant camera buffer area to a destination on a network.

## APPENDIX B

### References

This guide shall be used in conjunction with the following publications. If the following publications are superseded by an approved revision, the revision shall apply.

Automated Imaging Association. GigE Vision Standard Specification. Version 2.0. November 2011. May be superseded by update. Retrieved 3 June 2015. Available at [http://www.visiononline.org/form.cfm?form\\_id=701](http://www.visiononline.org/form.cfm?form_id=701).

European Machine Vision Association. Generic Interface for Cameras. Version 2.0. 11 June 2009. May be superseded by update. Retrieved 3 June 2015. Available at [http://www.emva.org/cms/upload/Standards/GenICam\\_Downloads/GenICam\\_Standard\\_v2\\_0.pdf](http://www.emva.org/cms/upload/Standards/GenICam_Downloads/GenICam_Standard_v2_0.pdf).

———. Standard Features Naming Convention. Version 2.2. 17 December 2014. May be superseded by update. Retrieved 3 June 2015. Available at [http://www.emva.org/cms/upload/Standards/GenICam\\_Downloads/GenICam\\_SFNC\\_2\\_2.pdf](http://www.emva.org/cms/upload/Standards/GenICam_Downloads/GenICam_SFNC_2_2.pdf).

Range Commanders Council. Telemetry Standards. Chapter 9, Telemetry Attributes Transfer Standard. IRIG 106-13. June 2013. May be superseded by update. Retrieved 3 June 2015. Available at [http://www.wsmr.army.mil/RCCsite/Documents/106%20Previous%20Versions/106-13\\_Telemetry\\_Standards/Chapter%209.pdf](http://www.wsmr.army.mil/RCCsite/Documents/106%20Previous%20Versions/106-13_Telemetry_Standards/Chapter%209.pdf).

———. Telemetry Standards. Chapter 10, Digital Recording Standard. IRIG 106-13. June 2013. May be superseded by update. Retrieved 3 June 2015. Available at [http://www.wsmr.army.mil/RCCsite/Documents/106%20Previous%20Versions/106-13\\_Telemetry\\_Standards/chapter%2010.pdf](http://www.wsmr.army.mil/RCCsite/Documents/106%20Previous%20Versions/106-13_Telemetry_Standards/chapter%2010.pdf).



**\* \* \* \* End of Document \* \* \* \***