



DOCUMENT 324-11

RANGE SAFETY GROUP

**GLOBAL POSITIONING AND INERTIAL MEASUREMENTS RANGE
SAFETY TRACKING SYSTEMS COMMONALITY STANDARD**

**WHITE SANDS MISSILE RANGE
REAGAN TEST SITE
YUMA PROVING GROUND
DUGWAY PROVING GROUND
ABERDEEN TEST CENTER
ELECTRONIC PROVING GROUND
HIGH ENERGY LASER SYSTEMS TEST FACILITY**

**NAVAL AIR WARFARE CENTER WEAPONS DIVISION, PT. MUGU
NAVAL AIR WARFARE CENTER WEAPONS DIVISION, CHINA LAKE
NAVAL AIR WARFARE CENTER AIRCRAFT DIVISION, PATUXENT RIVER
NAVAL UNDERSEA WARFARE CENTER DIVISION, NEWPORT
PACIFIC MISSILE RANGE FACILITY
NAVAL UNDERSEA WARFARE CENTER DIVISION, KEYPORT**

**30TH SPACE WING
45TH SPACE WING
AIR FORCE FLIGHT TEST CENTER
AIR ARMAMENT CENTER
ARNOLD ENGINEERING DEVELOPMENT CENTER
BARRY M. GOLDWATER RANGE**

NATIONAL AERONAUTICS AND SPACE ADMINISTRATION (NASA)

**DISTRIBUTION A: APPROVED FOR PUBLIC RELEASE,
DISTRIBUTION IS UNLIMITED**

This page intentionally left blank.

DOCUMENT 324-11

**GLOBAL POSITIONING AND INERTIAL MEASUREMENTS RANGE
SAFETY TRACKING SYSTEMS COMMONALITY STANDARD**

FEBRUARY 2011

Prepared by

RANGE SAFETY GROUP (RSG)

Published by

**Secretariat
Range Commanders Council
U.S. Army White Sands Missile Range,
New Mexico 88002-5110**

This page intentionally left blank.

TABLE OF CONTENTS

LIST OF FIGURES	iv
LIST OF TABLES	v
PREFACE	vii
ACRONYMS	ix
CHAPTER 1: INTRODUCTION.....	1-1
1.1 Basis of Authority	1-2
1.2 Range Safety Policy	1-2
1.3 Scope.....	1-3
1.4 Range Safety Performance Requirements	1-5
1.5 Acceptability at any Major Range and Test Facility Base.....	1-6
1.6 Multiple Range Safety Offices.....	1-6
1.7 Operational Constraints	1-7
1.8 Range Tracking System Operational Checkout.....	1-7
1.9 Range Tracking System Flight Approval Process	1-7
1.10 Tailoring of Requirements	1-10
1.11 Waiver Submittals.....	1-12
CHAPTER 2: CANDIDATE PERFORMANCE REQUIREMENTS.....	2-1
2.1 Range Tracking System General Performance Requirements (R) (I) (A) (S) (L) (Q) (M).....	2-1
2.2 Range Tracking System Airborne Environmental Performance Requirements (R) (I) (M) (A) (S) (L) (Q).....	2-3
2.3 RTS Component Requirements (R) (I) (M) (A) (S) (L) (Q).....	2-3
2.4 RTS Ground Support and Monitoring Equipment Requirements.....	2-9
CHAPTER 3 PERFORMANCE REQUIREMENTS VERIFICATION-TEST	3-1
3.1 Certification Process. (R) (I) (M) (A) (S) (L) (Q)	3-1
3.2 Component Performance Verification Tests (R) (I) (M) (A) (S) (L) (Q).....	3-3
CHAPTER 4: PERFORMANCE REQUIREMENTS VERIFICATION-ANALYSIS .	4-1
4.1 Range Tracking System General Analysis Requirements (R) (Q) (A) (S) (L)	4-1
4.2 Range Tracking System Failure Analysis (R) (Q) (A) (S) (L)	4-1
4.3 Range Tracking System Similarity Analyses (R) (Q) (A) (S) (L)	4-1
4.4 Range Tracking System Reliability Analysis (R).....	4-1
4.5 Range Tracking System Energy/Power Analysis (R).....	4-1
4.6 Range Tracking System Radio Frequency Link Analysis (R).....	4-2
4.7 Re-Use.....	4-2
4.8 Prior Flight History	4-2

4.9	Range Tracking System Radio Frequency Environment Analysis (R)	4-2
4.10	Breakup Analysis (R) (A)	4-2
4.11	Dynamic Simulation Analysis	4-2
4.12	Independence Analysis	4-2
4.13	Failure Modes and Effects Criticality Analysis (R) (I) (M) (A) (S) (L) (Q)	4-2
CHAPTER 5:	PERFORMANCE REQUIREMENTS VERIFICATION DOCUMENTATION.....	5-1
5.1	Range Tracking System Component Test History (R) (Q).....	5-1
5.2	Reporting In-Flight Anomalies (R) (Q) (A) (S) (L).....	5-1
5.3	Range Tracking System Radio Frequency Link Analysis (R) (Q)	5-1
5.4	Radio Frequency Downlink Measurement List (M) (Q)	5-1
5.5	Range Tracking System Compliance Checklist.....	5-1
5.6	Other Documentation.....	5-1
APPENDIX A:	SUGGESTED APPROACHES FOR MEETING PERFORMANCE REQUIREMENTS.....	A-1
APPENDIX B:	FUNDAMENTAL PRINCIPLES FOR PERFORMANCE REQUIREMENTS.....	B-1
APPENDIX C:	TEST METHODS FOR GPS DYNAMIC SIMULATION TESTING..	C-1

LIST OF FIGURES

Figure 1-1.	Example of Document Layout	1-2
Figure 1-2.	Range Safety Approval Process	1-8
Figure 3-1.	Performance Verification Qualification Process Flow	3-2
Figure A3-1.	Narrow-Band Vibration Peak Clipping Procedures.....	A-10
Figure A3-2.	Co-location Test Setup.....	A-29
Figure A3-3.	Acceleration Test Profile for Dynamic Simulation Testing	A-32
Figure A3-4.	C/N ₀ Profile for Dynamic Simulation Testing	A-33
Figure A3-5.	Jerk Profile for Dynamic Simulation Testing	A-34
Figure B3.0-1	Example of Vibration Test Margin and Tolerances.....	B-24
Figure B3.0-2	Effect of Bandwidth Sampling on Vibration Data.....	B-24

LIST OF TABLES

Table 3-1.	Radio Frequency Acceptance Test Matrix.....	3-4
Table 3-2.	Radio Frequency System Qualification Test Matrix	3-5
Table 3-3.	Radio Tracking System and Downlink Component Acceptance Test Matrix.....	3-5
Table 3-4.	Radio Tracking System and Downlink Component Qualification Test Matrix.....	3-6
Table A3-0.	Test Tolerances	A-24
Table A3-2.	Recommended Dynamic Simulation/Analysis Test Approach.....	A-32
Table A3.2.5.2.	Minimum Power Spectral Density for Qualification Random Vibration	A-41
Table A3.2.6.1.	Minimum Power Spectral Density for Acceptance Workmanship Random Vibration.....	A-45
Table A3-1.	RF System Acceptance Test Matrix	A-49
Table A3-2.	RF System Qualification Test Matrix	A-50
Table A3-3a.	RF System Qualification Test Matrix	A-54
Table A3-4a.	GPS Receiver Test Requirements Qualification Test.....	A-55
Table A3-3b.	GPS Translator Test Requirements Acceptance Test	A-59
Table A3-4b.	GPS Translator Test Requirements Acceptance Test	A-60
Table A3-3c.	RF Downlink Transmitter Acceptance Test Matrix.....	A-62
Table A3-4c.	RF Downlink Transmitter Qualification Test Matrix	A-63
Table A3-3d.	Miscellaneous Component Acceptance Test Matrix (Includes Encoders, Multiplexers and Signal Conditioners)	A-64
Table A3-4d.	Miscellaneous Component Acceptance Test Matrix (Includes Encoders, Multiplexers and Signal Conditioners)	A-65
Table A3-3e.	Inertial Measurement Unit Test Requirements Acceptance Test.	A-66
Table A3-4e.	Inertial Measurement Unit Test Requirements Qualification Test	A-67
Table A3-3f.	Integrated/Coupled GPS/IMU Component Requirements Acceptance Test.....	A-69
Table A3-4f.	Integrated/Coupled GPS/IMU Component Requirements Qualification Test.....	A-70
Table A3-3g-1.	Accelerometer Test Requirements Acceptance Test	A-72
Table A3-4g-1.	Accelerometer Test Requirements Qualification Test.....	A-74
Table A3-3g-2.	Ring Laser/Fiber Optic Gyro Test Requirements Acceptance Test.....	A-76
Table A3-4g-2.	Ring Laser/Fiber Optic Gyro Test Requirements Qualification Test	A-77
Table A3-3h.	GPS Ground Translator Processor Acceptance Test	A-87
Table A3-4h.	GPS Ground Translator Processor Qualification Test	A-87

This page intentionally left blank.

PREFACE

This document presents the work performed by the Range Safety Group (RSG) of the Range Commanders Council (RCC). This document replaces the RCC Document 324-02, Global Positioning and Inertial Measurements Range Safety Tracking Systems Commonality Standard. Although this new edition contains minor editing to the document's main body, the main change is the addition of Appendix C as explained below.

This document contains requirements for airborne Global Positioning System (GPS) and Inertial Measurements tracking sources used for range safety purposes. The document structure makes it easier for range users to develop detailed requirements representing design and test solutions that will meet performance requirements of the specific Range Safety Office (also referred to herein as Range Safety). To address concerns associated with the ambiguity and contractual misinterpretation often resulting from performance requirements, the main body of text contains only performance-based requirements, while three appendices are included to assist the range user and Range Safety in developing detailed requirement's document. Appendix A offers "lessons learned" and standard industry practices as recommended solutions. Appendix B describes the rationale and safety concerns associated with the performance requirements and recommended solutions. Appendix C provides methodology for testing GPS metric tracking receivers/translators to the current performance standards contained in this document.

The RCC would like to thank the following individual for his efforts on development of this 2011 edition of RCC Document 324.

Task Lead: Mr. Martin Diaz
30th Space Wing (30 SW)/SEAE
806 13th ST, Suite 3
Vandenberg Air Force Base (AFB) 93437-5230
DSN 276-5778/COM (805) 606-5778
Phone: (805) 606-5778 DSN 276-5778
Fax: (805) 605-2589 DSN 275-2589
Email: martin.diaz@vandenberg.af.mil

Please address any questions to:

Secretariat, Range Commanders Council
ATTN: TEDT-WS-RCC
100 Headquarters Avenue
White Sands Missile Range, New Mexico 88002-5110
Phone: (575) 678-1107 DSN 258-1107
Fax: (575) 678-9517 DSN 258-9517
Email: wsmrcc@conus.army.mil

This page intentionally left blank.

ACRONYMS

2D	Two-dimensional
3D	Three-dimensional
AC	Alternating Current
AFB	Air Force Base
ANSI	American National Standards Institute
ATP	Acceptance Test Procedure
BER	Bit Error Rate
BIT	Built-in Test
C/A	Coarse/Acquisition
C/N ₀	Carrier-to Noise Density (ratio)
CE	Conducted Emissions
CEP	Circular Error Probable
cm	Centimeters
COTS	Commercial-off-the-Shelf
CS	Conducted Susceptibility
CW	Continuous Wave
DAGR	Defense Advanced GPS Receiver
dB	Decibels
dBw	Decibels relative to 1 milliwatt
DC	Direct Current
DGPS	Differential Global Positioning System
DGT	Digital GPS Translator
DOP	Dilution of Precision
DPR	delta pseudorange
Eb/N ₀	Bit Energy to Noise power spectral density
EMC	Electro-Magnetic Compatibility
EMI	Electro-Magnetic Interference
ESS	Environmental Stress Screening
FMECA	Failure Modes and Effects Criticality Analysis
FTS	Flight Termination System
FY	Fiscal Year
g	Gravity
G/T	Gain Noise Temperature Ratio
GHz	Giga-Hertz (1 billion Hertz)
GMT	Greenwich Mean Time
GPS	Global Positioning System
GTP	Ground Translator Processor
Hz	Hertz

IA	Input Axis
IAW	In Accordance With
ID	Identification
IEEE	Institute of Electrical and Electronic Engineers
IIP	Instantaneous Impact Prediction
IMU	Inertial Measurement Unit
INS	Inertial Navigation System
IRIG	Inter-range Instrumentation Group
IV&V	Independent Verification and Validation
Kohms	Kilo ohms
L1	Link 1 (1575.42 MHz) GPS satellite transmission
L2	Link 2 (1227.60 MHz) GPS satellite transmission
L3	Link 3 (1381.05 MHz) GPS satellite transmission
LNA	Low Noise Amplifier
M	Meters
M/s	Meters per second
MAGR	Miniature Air-Borne GPS Receiver
MHz	Megahertz (1 million Hertz)
MIL-HNDBK	Military Handbook
MIL-STD	Military Standard
MPE	Maximum Predicted Environment
MRTFB	Major Range and Test Facility Base
ms	Milliseconds
MTE	Minimum Time to Endanger
NFT	Navigational Functional Test
PDR	Preliminary Design Review
PI ND	Particle Impact Noise Detection
POC	Point of Contact
PP	Present Position
PSD	Power Spectral Density
RAIM	Receiver Autonomous Integrity Methodology
RF	Radio Frequency
RFP	Request For Proposal
RMS	Root Mean Square
RPER	Radial Position Error Growth Rate
RR	Reference Receiver
RSO	Range Safety Officer
RTS	Range Tracking System
RTSR	Range Tracking System Report

SNR	Signal to Noise Ratio
sps	Samples per second
TIMs	Technical Interchange Meetings
TM	Telemetry/Any Band
TMIG	
TSPI	Time, Space and Position Information
UAV	Unmanned Air Vehicle
USAEPG	U.S. Army Electronic Proving Ground (Ft. Huachuca, AZ)
UTC	Universal Coordinated Time
VAC	Volts Alternate Current
VDC	Volts Direct Current
VSWR	Voltage Standing Wave Ratio
WGS	World Geodetic System

CHAPTER 1

INTRODUCTION

This document has been prepared in an effort to establish a set of common performance and verification requirements for airborne Range Tracking Systems (RTS) including Inertial Measurements Units (IMU) and Global Positioning Systems (GPS). These performance and verification requirements assist Range Safety, RTS vendors/manufacturers, and vehicle integrators in identifying specific RTS Range Safety requirements. This document may be applied to a wide variety of vehicles, from spacelift to air-to-air missiles, to Unmanned Air Vehicles (UAVs). Proper tailoring of this document may also allow programs to be tested at multiple ranges. For purposes of this document, an RTS includes all systems, subsystems, and components necessary to provide adequate vehicle state-vectors and other data required for Range Safety decision-making. This document contains three sections (see Figure 1-1):

The main section contains five chapters. These chapters include the critical performance and verification requirements necessary for Range Safety personnel to evaluate a candidate RTS based tracking source.

Appendix A references corresponding paragraphs (see Figure 1-1) in the main section of the document. Appendix A provides detailed technical solutions to support the following objectives:

- Aid range users in developing an RTS that may be used on multiple Ranges for most vehicle configurations.
- Help Range Safety personnel and range users in evaluating a potential RTS against expected values. Values that are not consistent with expected results can be flagged and evaluated to ensure that there is no safety concern generated.
- Aid range safety and range users in implementing lessons learned.
- Provide an appropriate level of detail necessary for contractual efforts. The recommended solutions in this appendix act as “place holders” where experience has shown that misunderstandings often occur if a detailed requirement is not levied.

Appendix B references corresponding paragraphs in Appendix A and the main section of the document (see Figure 1-1). Appendix B describes the philosophy and explains the rationale for safety performance requirements. Appendix B must be evaluated in conjunction with Appendix A. **Note:** Not all performance and Appendix A requirements have corresponding Appendix B descriptions.

Appendix C provides methodologies for performing dynamic simulation tests identified in Appendix A, paragraph A3.1.7, TEST 2.

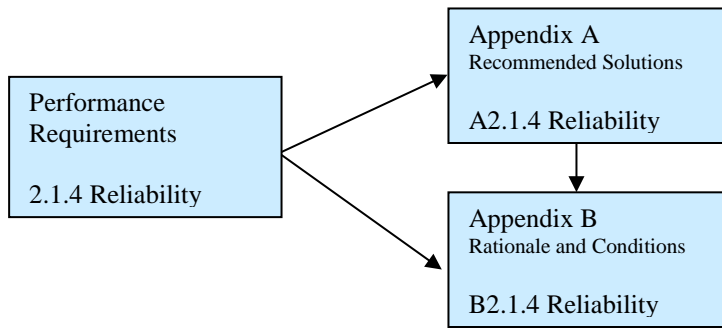

Figure 1-1. Example of Document Layout

1.1 Basis of Authority

Department of Defense Directive 3200.11, 17 Jun 83, (26 January 1998) establishes the Major Range and Test Facility Base's (MRTFB's) responsibilities for test and evaluation activities. The directive assigns the Range Safety responsibility to the specific activity or range Commander. No provisions are made for transferring this responsibility to the range user or to another range. Consequently, while establishing common agreements and practices among all ranges, Range Safety personnel at each affected range are entrusted with the responsibility to establish and enforce the safety policies of their respective ranges.

1.2 Range Safety Policy

The Range Safety policy is defined in the test management process and policies as a function of the specific range, vehicle under test, mission scenario, and other safety constraints. The process, though fundamentally the same at most ranges, often varies among ranges due to geographical or other limitations of that specific Range. However, the primary safety requirement at all Ranges is the same: protection of life and property. A secondary objective is the assurance of mission success. RTS mission assurance protection requirements are described within this document to aid range users in understanding how the RTS could impact their mission reliability. Without these explanations, a range user may be unaware of the risk to their mission from a particular RTS configuration. With a full understanding of the risks and options, the range user can opt to accept the mission risk posed by a particular RTS or select an RTS configuration that minimizes mission risk. The fundamental safety test management process is predicated on taking all prudent and reasonable steps to minimize the level of risk to the public, to mission essential personnel supporting the test operation, and to the vehicle under test.

In most cases, real-time Range Safety test management requires monitoring of vehicle performance in-flight by the Range Safety Officer (RSO). The RSO is a generic term used in this document to designate the individual or individuals responsible for making range safety decisions, particularly flight termination decisions. During real-time, the RSO is delegated the authority to execute the range Commander's range safety policies and has sole responsibility for making range safety decisions. In those instances where a vehicle failure occurs in-flight, the RSO maintains an acceptable level of risk to life and property by terminating or constraining flight before an unsafe condition can occur. The RSO can also terminate or constrain flight if

positive assurance is not provided that the flight is proceeding in a safe manner. Displays derived from metric data are critical to the RSOs decision-making process. In many cases, failure of the tracking source, or failure to properly process and display the information, may lead to a flight termination action in order to assure public safety.

For most applications, a minimum of two independent tracking sources is required to assure public safety. However, additional tracking sources may provide flexibility and increase the probability of mission success. Depending on the specific mission scenario, if the two tracking sources disagree, information from the worst-case data source may be used to determine whether an action should be taken to terminate or constrain flight. Also, a failure that results in only one remaining RTS source of tracking creates a safety concern where the remaining source must be relied upon and assumed to be valid. If the one remaining source produces undetectable false position data, this could result in an errant vehicle violating Range Safety public risk criteria. Range safety will typically establish mission rules to account for a tracking source being lost during flight. Therefore, the probability of failure modes for these tracking sources is of special concern, especially when only a single source is remaining. It is the intent of this document to permit a nominal vehicle to continue flight should an RTS (Inertial Measurement Unit (IMU) or Global Positioning System (GPS)), compliant with this document, be the only remaining source due to a failure of another RTS source. However, the applicable range must agree upon mission rules for each specific mission.

1.3 Scope

This document is intended as a tool to aid range users in developing detailed tracking solutions that will meet range safety performance requirements for use on multiple ranges in a wide variety of vehicles applications. Since this document only levies safety performance requirements, it is the responsibility of the range user to develop detailed solutions that satisfy these performance requirements. When the requirements definition process is complete, it is expected that the final requirements document to be used for contractual purposes will be similar in detail to Appendix A. This document provides the framework to develop these detailed technical solutions as described below:

1.3.1 The candidate performance requirements are intended as a “checklist” of potential concerns and are not meant to be implemented indiscriminately. Solutions are included in the appendices of this document. The numbering scheme used in the appendices matches the requirements in the main document. For example, a performance requirement in [Section 2.3](#) may have a recommended solution in [Appendix A2.3](#).

1.3.2 In addition to recommended solutions for performance requirements, [Appendix B](#) is provided to explain the philosophy, policy and rationale for a particular requirement. This appendix is intended to help range users understand the intent of a particular requirement and guide them to develop alternative solutions.

1.3.3 The RTS shall be effective throughout all segments of flight for which Range Safety has responsibility for ensuring public safety. The RTS reliability, state vector accuracy, sample rate or latency requirements may be relaxed depending on vehicle configuration, launch profile,

and phases of flight. For example, it may be necessary to have more stringent state vector requirements for the early phases of vehicle flight than in the latter stages.

1.3.4 Requirements in this document assume the airborne GPS or IMU as a primary means of tracking. When additional qualified and approved range support tracking is provided (e.g. transponder radar track or optics), the level of compliance with this document may be decreased significantly or even eliminated. Determination of the applicability of these requirements should be determined by the responsible Range Safety organization during the candidate requirement selection or “tailoring” process.

1.3.5 Each candidate requirement that follows has a top-level reference performance requirement in parenthesis at the beginning of the paragraph. The symbols for these references are described in Section 1.4. The purpose of this interaction is to assist a range user in understanding the overall top-level safety performance requirement relating to a candidate performance requirement or configuration. This association also helps reduce the level of effort necessary to assess a proposed RTS by allowing identification of the requirements of interest. For example, if there are sufficient tracking sources, candidate requirements that reflect reliability (R) could be significantly reduced or even eliminated since a loss of GPS tracking data would not be critical due to the availability of alternate tracking sources.

1.3.6 The launch vehicle system determines the specific RTS performance and performance verification requirements for that program; therefore, RTS systems approved for one program should not be automatically accepted for another program. If an existing RTS used for one program is to be utilized on another program, there should be a new tailoring effort to identify potential concerns such as changes in flight environments, antenna patterns and dynamic tracking capability. Decisions on tailoring or implementation of this document should be made by a mutual agreement between the range user and all Range Safety Offices involved.

1.3.7 Corrected P (Y) code Time, Space and Position Information (TSPI) data may introduce specific security issues that are not addressed in this document. Unique requirements for classified P (Y) and unclassified (Y) code GPS hardware will be addressed on a case-by-case basis as part of the tailoring effort.

1.3.8 Since performance requirements can often be subject to varying contractual interpretations, it must be understood that a particular Range Safety Office has final interpretation authority and responsibility to determine whether a proposed range user’s detailed solution meets a safety performance requirement.

1.3.9 A primary benefit of this document is to allow RTS vendors/manufacturers and vehicle integrators to design and test components that can be utilized on a wide variety of ranges and airborne vehicle systems. It is the intent of this document to recommend configurations and test criteria in the appendices, which will maximize a potential vendor’s market. If a narrower market is desired (e.g. tactical missiles or UAVs), then some of the candidate requirements and recommended solutions can be deleted or tailored. Compliance to this document and the recommended solutions in the appendices does not guarantee blanket approval at all ranges for

all vehicle applications. However, it should maximize common hardware usage for multiple vehicle classes at most ranges.

1.3.10 Though this document is intended for airborne GPS and IMU tracking, many of the performance requirements in the main section can be used as a checklist to develop ground system requirements. **Note:** This document was unable to address range ground architecture due to the diverse capabilities and missions between ranges. Any tailoring for ground systems will have to be handled on a case-by-case basis for each specific application.

1.3.11 This format should provide the following benefits:

- Safety performance requirements dictate why a particular recommended solution is critical to safety. With this understanding, range users can develop innovative processes that meet safety requirements more easily.
- Appendix A maintains the “lessons learned”, industry practices and history accumulated throughout the years as *recommended solutions* that would be addressed during the range user proposal review.
- Detailed recommended solutions in Appendix A provide a checklist for Range Safety representatives to evaluate a range users proposal and to ensure that critical items are not inadvertently omitted.
- It is sometimes more cost and time effective to have a detailed solution rather than conducting a “science experiment” for each requirement. By including the accepted practices as appendices, range users can meet a recommended solution instead of “reinventing the wheel”.
- Safety performance requirements call for the range user to demonstrate that their system is safe to the public and not just compliant with detailed solutions.
- Since the requirements are performance oriented, it is up to the range user to describe how each requirement will be met. The recommended solutions in the appendices offer a template of the level of detail required to demonstrate compliance. Range Safety is not generating or requiring any particular detailed solution; the range user must develop the detailed solutions. Range Safety is responsible for reviewing range user-generated detailed solutions to determine if the proposed solutions satisfy safety performance requirements.
- The detailed solutions generated by the range user should be negotiated (tailored) to develop a requirements document for the program. Tailoring is simplified since only performance requirements need to be dispositioned.

1.4 Range Safety Performance Requirements

The ability to ensure that an adequate level of public safety is maintained is determined by the following top-level performance requirements. All candidate requirements have been derived from these core requirements. Each candidate requirement in Chapter 2 through Chapter 5, Appendix A and Appendix B references the seven top-level performance requirements, where applicable. These references are conveyed through the appropriate performance requirement symbol in parenthesis described at the beginning of each paragraph. Not all top-level requirements are applicable to all vehicles at all ranges. Each range will assess

the applicability of these requirements based on vehicle under test, the proposed RTS application, and the specific mission scenario. The seven top-level performance parameters and definitions are as follows:

- Reliability (R) – The basic requirement at each range is for a reliable tracking source that will ensure the RSO has the necessary information to make critical real-time safety decisions. A second requirement involves the probability of an RTS to produce undetectable out-of-specification state vector data.
- Independence (I) - Reliable tracking data is acquired at most ranges through the use of independent tracking sources. The intent of independence is to ensure that a failure of one tracking system will not degrade the performance of another tracking system and to minimize the likelihood of unidentified common cause failure mode.
- Measurement Set (M) – The measurement set includes time, space, position, and any other information necessary to monitor the vehicle’s in-flight performance. Examples include vehicle position, velocity, and attitude.
- Accuracy (A) – Accuracy is defined as the statistical difference between a measured and true value. The true value represents the best estimate of trajectory for the analyzed mission.
- Sample Rate (S) – Sample Rate is defined as the rate at which the required state vector or other data is supplied for Range Safety personnel processing and display.
- Latency (L) – The latency is the delay between when a measurement is taken and when that measurement is available for decision making at the Range Safety displays.
- Quality/Confidence Indicators (Q) – These indicators are health and other status monitors that provide quality indication of the tracking data and provide the RSO with some level of confidence in the data.

1.5 Acceptability at any Major Range and Test Facility Base

Airborne tracking systems, meeting the requirements of this document, will be acceptable for use for a *specific* flight vehicle and range. With the exception of specific launch vehicle operating and non-operating environments, RTS hardware developed with the recommended design and test solutions in this document should maximize common hardware usage for many types of vehicles at most ranges.

1.6 Multiple Range Safety Offices

For systems that launch from multiple ranges, the range user is responsible for keeping each Range Safety Office informed on the program. No range has the authority to accept/reject a design, request, etc. for another activity Commander. When waivers are required, it is the range user's responsibility to resolve these issues directly with each Range Safety Office involved.

1.7 Operational Constraints

Range users are cautioned that ground and flight operational constraints may vary from range to range; consequently, what is acceptable at one range may not be permitted on another. Adherence to the performance requirements and recommended solutions described in this document will produce RTS hardware that can be used at most MRTFBs without modification or retest. If a modification is made to the qualified flight vehicle or RTS configuration, a review by the Range Safety Office of each subsequent launching range is often necessary to determine whether additional testing or design modification is required or new mission rules should be implemented.

1.8 Range Tracking System Operational Checkout

The operational checkout of the RTS falls under the purview of each affected range. Range Safety Office and other range representatives should monitor and evaluate the acceptability of tracking data during the launch countdown or preflight process. To perform this function, the range user may be required to provide a RF downlink console.

1.9 Range Tracking System Flight Approval Process

1.9.1 Flight Approval Process

As discussed earlier, the implementation of Range Safety requirements varies from range to range. Similarly, the approval process at individual ranges may also vary depending on organizational structure, operational test support capabilities, and other factors. The approval process defined in this document (Figure 1-2) is designed to ensure proper coordination between the affected range and the range user from the early vehicle design and development stages through the range pre-flight tests. All ranges may not follow this process, but it is strongly recommended. By reviewing the candidate requirements in this document and tailoring the requirements to the specific application, the range and range user can jointly develop the most appropriate mission specific subset of requirements. The need for dynamic simulations should also be assessed during the tailoring process. The tailoring process is detailed in Section 1.10. The tests are briefly discussed below and are also detailed in later chapters of this document.

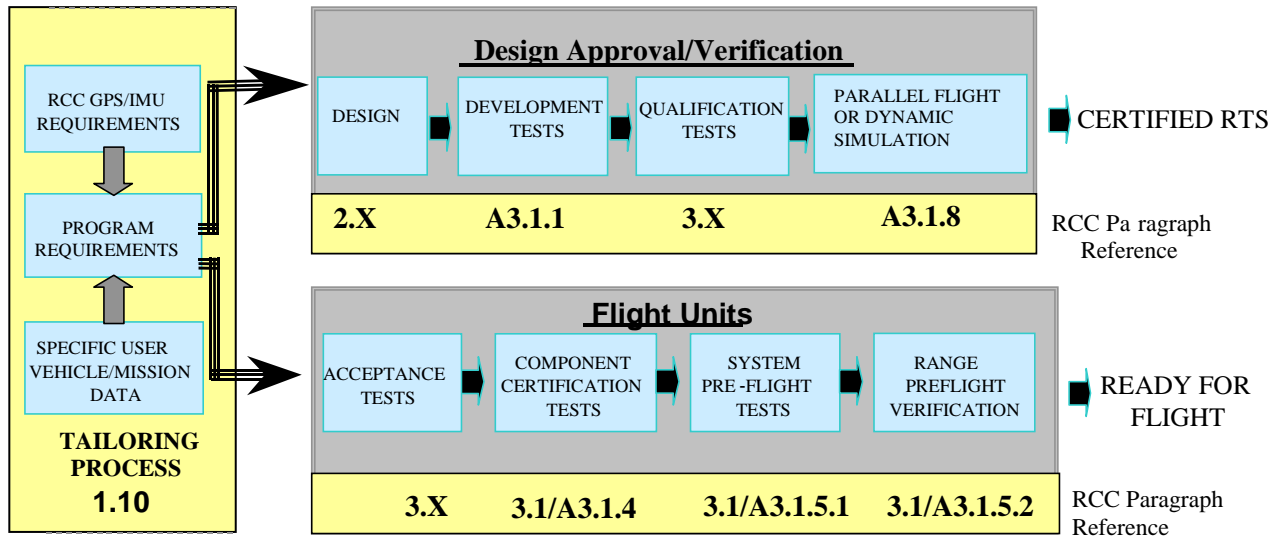

Figure 1-2. Range Safety Approval Process

- Design Development Tests validate hardware design concepts and assist in the evolution of designs from the conceptual phase to the operational phase. The objective of these tests is to identify hardware problems early in their design evolution, so any required corrective actions can be taken prior to beginning formal Qualification testing and production hardware fabrication.
- Qualification Tests are range user/vendor functional tests of flight representative hardware system or component designs to ensure suitability of the design to reliably operate and provide expected results during and after exposure to certain physical environments. Functional performance and dynamic simulation tests would be conducted during component qualification testing in a laboratory type environment designed to validate specific range safety-related performance parameters.
- Acceptance Tests are conducted at the range user/vendor facilities to demonstrate that each production end item meets the requirements of the specification and to reveal production inadequacies.
- Certification Tests are conducted on RTS components prior to installation in a higher assembly or vehicle to certify them for flight. These tests are usually required if a significant amount of time has elapsed since the last detailed performance functional test.
- Range Pre-Flight Tests involve subsystem level and system level tests and are typically conducted at the range.
- Launch Countdown Verification involves a final checkout of the entire system (end-to-end) just prior to launch.

1.9.2 Dynamic Simulations

Dynamic simulation testing is a means of further assessing the ability of a GPS based tracking system to meet specific range safety performance requirements and may be used as an alternative or supplement to the parallel certification flight-testing concept. The dynamic simulation concept includes testing of the GPS system with simulated flight trajectories, antenna patterns, lever arms, and simulated GPS signals in an effort to assess how the proposed GPS will perform under flight conditions. The dynamic simulations shall be performed not only for nominal flight conditions, but also for non-nominal vehicle failures conditions and worst-case degraded conditions. Data generated during these dynamic simulations allow evaluation of specific performance parameters of special interest (e.g. degraded accuracy or reacquisition during high dynamic operation).

1.9.3 Parallel Certification Flight Tests

Parallel Certification Flight Tests may be required. These tests would entail flight-testing, a proposed RTS in addition to traditional certified tracking source (e.g., radar and TMIG) as a means of “certifying” the new RTS. This may only be required for new RTS design/technologies. It may be possible to use dynamic simulation tests in lieu of parallel flight tests if it can be shown that the dynamic simulation is an accurate representation of the flight environment. The requirement for parallel certification flight tests shall be discussed as part of the tailoring process between the range and range user.

1.9.4 Early Coordination

Range users are strongly urged to coordinate with the Range Safety Offices involved as early as practical to ensure proper recognition and interpretation of safety performance requirements and recommended solutions. This is particularly important when the vehicle is to be flown at more than one range.

1.9.5 Design Reviews/Technical Interchange Meetings

Concept design reviews, preliminary design reviews, and critical design reviews (which involve the RTS), should include participation by Range Safety. Meeting dates should be coordinated with Range Safety to ensure proper participation. Supporting data should be provided within an agreed time frame, typically 14 calendar days prior to the scheduled meeting.

1.9.6 Final Range Tracking System Approval

Final range approval of the RTS should be requested at least 60 days prior to the start of flight test operations. This final review assesses the performance parameters of the tailored requirements document against the RTS configuration. After final review and approval by Range Safety personnel, continued coordination shall be maintained to ensure that any modifications to the RTS do not invalidate the previously agreed to mission rules.

1.10 Tailoring of Requirements

1.10.1 Introduction

The test requirements in this document should be tailored to fit the specific RTS hardware design and application at a specific range(s). These tests are not intended to be inflexible compliance requirements and should instead be viewed as a checklist to address potential concerns. Suggested configurations in the appendices are used as a benchmark to compare proposed hardware with expected values experienced on similar technology. These approaches also allow vendors insight into the criteria, which Range Safety will use to assess the expected performance of proposed hardware. Configurations included in the appendices are for reference only and it is understood that different vendors may have contrasting specifications that require technical evaluation. Detailed values are also used to identify out-of-family measurements or degradation in performance, which could indicate that a flight article may contain deficiencies not screened during acceptance testing. These deficiencies may not result in a system failure (i.e. inability to obtain tracking data) during ground processing, but could lead to in-flight failures when subjected to flight environments. New technology and/or unique applications of existing technology may require adding tests not contained in this document.

1.10.2 Tailoring Process

1.10.2.1 Candidate requirements should be tailored by agreement between the range user and all Range Safety Offices involved. It is the range user's responsibility to ensure that the tailoring involves all of the participating ranges. The tailoring is a continuing process throughout all phases of system acquisition, design and test: Request For Proposal (RFP), pre-bid conferences with bidders, concept Technical Interchange Meetings (TIMs), Preliminary Design Reviews (PDRs), etc. Tailoring agreements and the design/test/inspection concepts upon which the tailoring is based should be formally documented including approval signatures. Compliance to the tailoring is necessary to ensure that mission rules are valid.

1.10.2.2 A tailored edition of this document should be developed by the affected Range Safety Offices to fit the peculiar requirements of a specific program. The ranges should develop this tailored document with range user participation in the tailoring process. The purpose of tailoring this document is to generate a detailed requirement representing solutions to range safety performance requirements. In this document, critical range safety performance requirements and related requirements are written as “**shall’s**” in the main body of the document, which again need to be tailored for each individual application. Candidate requirements contained in the appendices of this document are written as recommendations. If this document is to be utilized as a contractual mechanism, then the level of detail reflected in the candidate requirements in Appendix A must be rewritten as “**shall’s**” during the tailoring process.

- Tailoring should begin at the earliest opportunity (preferably at the conceptual stage). ***The tailored version of this document should be placed on contract. Therefore, tailoring should be performed prior to contract award.***

- An initial TIM is strongly recommended. Material should be provided that describes, in detail, the vehicle configuration and proposed RTS component and system design. This TIM is necessary to identify the baseline, for which tailoring can be performed and to identify ground rules.
- The performance requirements in the main section and their corresponding recommended solutions should be tailored concurrently. ***Tailoring should only be performed on the performance requirements in the main document and the solutions in Appendix A. Appendix B is for information only and does not need to be tailored.*** **Note:** Most of the tailoring effort will be performed on Appendix A where agreements will be made on the detailed implementation of the performance requirements in the main document. For contractual efforts, Appendix A will become the driving document for hardware vendors. However, the performance requirements in the main section must remain on contract in the event the tailored Appendix A solutions are inadequate or need to be changed.
- Documenting the rationale for not meeting a particular requirement or recommended solution may be crucial if the system is significantly modified or used at another range. By understanding how each requirement and recommended solution has been addressed, a complete reassessment may not be necessary if the RTS is used at a different range.
- Performance requirements are not specific and are open to various technical and contractual interpretations. Therefore, it is necessary that as much detail as possible is put into the agreed upon implementation of solution for each performance requirement to minimize misunderstandings. In the event of varying interpretations, Range Safety has sole interpretation authority and responsibility in making a final determination on whether a range user proposed solution meets a corresponding performance requirement.
- The intent of this document is to aid the range user and Range Safety in generating a detailed requirement's document that has a similar amount of detail as in Appendix A.

1.10.3 Disposition of tailored requirements

Range users should identify potential discrepancies associated with the requirements in this document. Each requirement should be dispositioned and documented as follows:

1.10.3.1 Compliant - The proposed design or test concept meets the requirement or recommended solution as written.

1.10.3.2 Deletion of a Requirement - When a requirement is not applicable to a range user program, the requirement should be dispositioned as "non-applicable" and deleted in the final requirements document.

1.10.3.3 Meets Intent Certification/Requirement – This is used when range users do not meet the exact requirements, but do meet the intent of the requirements. Changing a requirement is acceptable if the new requirement provides an equivalent level of capability.

1.10.3.4 **Waivers** - Waivers are required where a noncompliance could pose a significant public safety risk. Non-conformances to requirements will be assessed for acceptance by each range Safety Office and changes of mission flight rules may be necessary to ensure public safety. Waivers typically have a limited time or vehicle-number effectively and require long-term corrective action. Waivers will be granted only under unique and compelling circumstances. Range Safety and the range user should jointly endeavor to ensure that requirements of this document are addressed as early in the design process as possible to limit the use of waivers to a minimum. Individually, each range Commander has the authority to change, or waive any requirement in this document for a specific program or mission operating at a respective range. Each range Commander has the authority to accept additional risks for a specific mission based on national or mission need.

1.10.4 Addition of a Requirement

An addition of a requirement is allowed when there are no existing requirements addressing new technology, when unforeseen hazards are discovered, when federal or industry standards change, and for similar reasons. An addition should be included with new paragraph numbers in the section for which it is appropriate or in a new section if no other section applies.

1.11 Waiver Submittals

The range user shall submit adequate justification for waivers from tailored requirements. Each applicable range involved shall approve all waivers. Ranges, which were not involved in the original process, have the right to restore the requirements of this document for any program wishing to conduct operations at their ranges. Supporting data for the waiver or deviation request should include:

- A statement of the technical or other requirement, which makes the waiver necessary (i.e. creates a public safety concern).
- A discussion of the effect on RTS performance functions if the waiver is granted and the effect on public health and safety.
- A discussion of the effect on the program if the waiver or deviation is not granted.
- A detailed description of the proposed flight tests or operations.

CHAPTER 2

CANDIDATE PERFORMANCE REQUIREMENTS

The following candidate performance requirements are intended to be used as a “checklist” of potential requirements that can be deleted or modified during the tailoring process. The letters in parentheses identify the top-level performance requirement described in Chapter 1 for which these candidate requirements are derived.

2.1 Range Tracking System General Performance Requirements

(R) (I) (A) (S) (L) (O) (M)

RTS performance shall ensure that a flight vehicle’s state vector can be positively ascertained in order to protect the public throughout the period of Range Safety responsibility. The RTS shall meet the requirements of this section for planned and unplanned flight conditions during the period of Range Safety responsibility. After a baseline has been established and approved, any changes to the requirements of this section shall be coordinated with Range Safety. The paragraphs within this section are applicable to airborne and ground components, subsystems and systems (except where noted).

2.1.1 Range Tracking System Software and Firmware (R) (A) (S) (L) (Q)

RTS software and firmware shall support the required RTS tracking performance throughout the period of Range Safety responsibility in accordance with the requirements of this document.

2.1.2 Range Tracking System Software and Hardware Component Failure Modes (A) (S) (L)

RTS software and component hardware failure modes, capable of producing an undetectable real-time out-of-specification state vector (e.g. accuracy, sample rate and data latency), shall be identified to Range Safety. The probability and severity of the failure mode shall be reviewed by Range Safety to determine the acceptability of the proposed source and to generate operational mission constraints, if necessary.

2.1.3 Sample Rate (S)

The specified sample rate(s) of the RTS system, including Telemetry/Any Band (TM) downlink and ground processing, shall ensure that the data delivered to ground processing systems is sufficient to ensure that a non-nominal flight can be detected and terminated prior to public endangerment or loss of flight control. The sample rate shall be specified by the range user and not changed without Range Safety approval. Notification of changes in the RTS ground or airborne systems shall be provided by the range or range user, as appropriate, and may require Range Safety reevaluation. The specified sample rate(s) shall be maintained throughout the flight period of Range Safety responsibility. Each sample shall be a unique measurement and not a repeat or extrapolation of the previous value.

2.1.4 Range Tracking System Reliability (R)

- The RTS reliability for a nominal mission shall ensure that the minimum number of required tracking sources (two in most cases) are available at least 97 percent of the time-period of Range Safety responsibility.
- Any RTS source used for Range Safety shall have a singular reliability of 97 percent.
- The probability that an RTS tracking source produces real-time undetectable out-of-specification state vector data shall be less than 10^{-3} .
- The probability of an RTS to show that a non-nominal vehicle is nominal must be less than 10^{-6} .

2.1.5 Range Tracking System Life (R) (A)

RTS components shall function within specification throughout their specified life. RTS components must be flown while within their specified operating and storage life.

2.1.6 Range Tracking System Airborne Electrical and Electronics Subsystems (R) (A)

RTS electrical systems shall ensure that the RTS meets the required performance of this document from the start of a mission to the end of Range Safety responsibility.

2.1.7 Interference Protection (R)

The RTS shall function as required when exposed to Radio Frequency (RF) ground systems and flight vehicle RF radiating or conducted emissions. The RTS component shall not emit or conduct RF energy, which could adversely affect other vehicle components (e.g. Flight Termination System (FTS) components).

2.1.8 System Delay Time (L)

The total system delay time, including delays in RTS, FTS and RSO reaction time, shall ensure a non-nominal vehicle flight can be detected prior to vehicle breakup, loss of destruct capability or violation of destruct line criteria. The delay (data latency) introduced by each component or subsystem of the RTS shall support the total system delay requirement. This system delay time calculation shall be measured from airborne sensor or RF reception through the Range Safety display including any data buffering, transfer, processing, or smoothing.

2.1.9 Independence (I)

All required tracking sources shall be independent of each other to the extent necessary to ensure that a failure of one tracking source does not adversely affect any required performance parameter of the other.

2.1.10 Accuracy (A)

The accuracy of the state vector delivered to the ground safety display systems shall be sufficient to ensure that a non-nominal flight vehicle can be detected and terminated prior to vehicle breakup or loss of destruct capability. The accuracy of the range users' entire airborne and applicable ground RTS shall be specified to support development of Range Safety destruct criteria. The range users' RTS accuracy shall be factored into any range supplied ground systems to ensure the overall accuracy meets Range Safety requirements. The required accuracy shall be maintained throughout nominal vehicle flight. The RTS shall not produce out-of-specification state vector accuracy during non-nominal flight. The specified accuracy shall include noise and systematic errors.

2.1.11 Quality/Confidence Indicators (R)(Q)

The RTS shall provide indications of system performance status. This data shall allow real time evaluation of the critical performance parameters. Quality indicators (flags) shall be made available for detectable events that result in out-of-specification state vector performance data.

2.1.12 Number of Range Tracking System Sources

The number of required tracking sources shall be provided from beginning of mission to the end of Range Safety responsibility to ensure that an non-nominal vehicles can be detected. This ability to detect an errant vehicle includes addressing potential failures occurring in the RTS, which could produce undetectable out-of-specification state vector data (i.e. false position data).

2.2 Range Tracking System Airborne Environmental Performance Requirements (R) (I) (M) (A) (S) (L) (Q)

All RTS components and subsystems shall support the overall RTS system performance to ensure that a flight vehicle's state vector can be positively ascertained throughout the period of Range Safety responsibility. The RTS system shall meet the performance requirements of this document for planned and unplanned vehicle operations and environments during the period of Range Safety responsibility.

2.3 RTS Component Requirements (R) (I) (M) (A) (S) (L) (Q)

The following candidate requirements address detailed component (i.e. Black-box) level requirements that make up the RTS. These requirements are expected to apply throughout all portions of vehicle flight.

2.3.1 Airborne RTS Antenna System (R) (A)

The antenna system shall support the RTS capability to meet safety performance criteria and component specification throughout the period of Range Safety responsibility.

- The TM downlink antenna system shall support the required system performance requirements of this document and the required reliability to transfer data during nominal and non-nominal vehicle flight.
- The GPS L-band antenna(s) shall support the system performance requirements of this document and the required reliability to maintain specification performance state vector data throughout vehicle flight.

2.3.2 Airborne Ground Positioning System Receiver Performance Requirements (R) (I) (M) (A) (S) (L) (Q)

The receiver and receiver/IMU design shall meet all performance requirements and specifications from acceptance testing through end of Range Safety responsibility.

- **Maximum Dynamic Range (R) (A).** GPS components shall function within their performance specification when subjected to the minimum and maximum RF L-band input.
- **Input Voltage (R) (A) (L).** GPS components shall function within their performance specification when subjected to worst-case minimum and maximum circuit voltage of the flight vehicle power source. RTS components shall not be damaged by the application of worst-case open circuit voltage of the flight vehicle power source.
- **Navigation Data Validity (R) (A) (D) (L) (S) (M) (Q).** RTS components shall be designed to prevent a single failure from producing out-of-specification performance data unless there are quality indicators available in real-time that can identify any suspect data.
- **Immunity to Interfering Signals (R).** All RTS components shall demonstrate that they meet all Range Safety required performance parameters when subjected to radiated or conducted emissions from all flight vehicle systems and expected external ground transmitter sources. In addition, components shall not radiate or conduct electromagnetic interference to flight termination system or vehicle components that would degrade the performance of those components below specification.
- **State Vector (A).** RTS components shall provide a state vector that meets range safety performance requirements under all dynamic conditions of the vehicle while under Range Safety responsibility.
- **Data Rate (S).** The state vector or any data required to generate a state vector shall be updated at a rate that supports Range Safety requirements. Other measurement data shall also be provided at a rate (which may be different than state vector data) which supports Range Safety requirements.
- **Delay Time (L).** The RTS airborne component delay from L-band input to generation of state vector shall support the overall Range Safety data latency requirement.

- **Measurement Set (M) (Q).** RTS components shall provide RF downlink data to support performance criteria required by each individual range.
- **Rapid Re-Lock Capability (L) (R) (A).** The rapid re-lock time shall prevent an unacceptable loss of tracking as required by each particular range for each vehicle application.
- **Time to First Fix (R) (A).** Time to first fix shall support vehicle pre-launch timelines. For vehicles that must lift-off prior to GPS acquisition (e.g. submarine, canister and silo launches), RTS components shall be capable of providing the required tracking data performance prior to the time in which a non-nominal vehicle can violate public safety risk criteria.
- **De-Selection of Faulty Satellites (R) (A) (Q).** RTS components shall meet state vector reliability and accuracy requirements should a fault occur in a GPS satellite.
- **Acquisition Capability (R).** GPS components shall be capable of tracking sufficient satellites to support Range Safety required reliability and accuracy requirements.
- **Quality/Confidence Indicators (R)(Q).** RTS components shall provide indications of system performance status. This data shall allow real time evaluation of the critical performance parameters and determination of anomalous conditions that create an out-of-specification state vector.
- **Warm-up Time (A) (L).** The maximum time required after application of power for an RTS component to reach its required accuracy level shall support pre-flight timelines.

2.3.3 Ground Translator Processor Receiving/Processing Performance Requirements (R) (A) (L)

- **Maximum Dynamic Range (R) (A).** The Ground Translator Processor (GTP) shall function within its performance specification when subjected to the minimum and maximum RF L-band input down linked through the translator to the receiving ground station.
- **Navigation Data Validity (R) (A) (D) (L) (S) (M) (Q).** The GTP shall be designed to prevent a single failure from producing out-of-specification performance data unless there are quality indicators available in real-time that can identify any suspect data.
- **Immunity to Interfering Signals (R).** The GTP shall demonstrate that it meets all Range Safety required performance parameters when subjected to expected ground transmitter sources.
- **State Vector (A).** The GTP shall provide a state vector that meets range safety performance requirements under all dynamic conditions of the vehicle while under Range Safety responsibility.
- **Data Rate (S).** The GTP shall update the state vector at a rate that supports Range Safety requirements. Other measurement data shall also be provided at a rate (which may be different than state vector data), which supports Range Safety requirements.
- **Delay Time (L).** The GTP delay from S-band input to the ground-receiving antenna shall support the overall Range Safety data latency requirement.
- **Measurement Set (M) (Q).** The GTP shall provide data to support performance criteria.

- **Rapid Re-Lock Capability (L) (R) (A).** The rapid re-lock time shall prevent an unacceptable loss of tracking.
- **Time to First Fix (R) (A).** Time to first fix shall support vehicle pre-launch timelines. For vehicles that must lift-off prior to GPS acquisition (e.g. captive carry, submarine, canister, and silo launches), RTS components shall be capable of providing the required tracking data performance prior to the time in which a non-nominal vehicle can violate public safety risk criteria.
- **De-Selection of Faulty Satellites (R) (A) (Q).** The GTP shall meet state vector reliability and accuracy requirements should a fault occur in a GPS satellite.
- **Acquisition Capability (R).** The GTP shall be capable of tracking sufficient satellites to support Range Safety required reliability and accuracy requirements.
- **Quality/Confidence Indicators (R)(Q).** The GTP shall provide indications of system performance status. This data shall allow real time evaluation of the critical performance parameters and determination of anomalous conditions that create an out-of-specification state vector.
- **Warm-up Time (A) (L).** The maximum time required after application of power for an RTS component to reach its required accuracy level shall support pre-flight timelines.

2.3.4 Differential Global Positioning System Performance Requirements (R) (A) (Q) (M)

The vehicle shall downlink the necessary data for Differential Global Positioning System (DGPS) range processing. Ground systems shall be capable of integrating ground generated correction data with flight data to ensure compliance to all performance requirements of this document.

2.3.5 Airborne Inertial Measurement Unit Performance Requirements (R) (I) (M) (A) (S) (L) (Q)

The IMU shall meet all performance requirements and specifications from acceptance testing through end of Range Safety responsibility.

- **Alignment and Calibration (R) (A) (D) (L) (S) (M) (Q).** The IMU shall provide sufficient precision in the process that aligns/initializes vehicle axes to navigation axes to ensure that tracking accuracy requirements can be met throughout flight. The IMU instrumentation shall be calibrated, and the measurement errors should be sufficiently stable, so that the inertial only solution will meet accuracy requirements.
- **Input Voltage (R) (A) (L).** IMU components shall function within their specified performance specification when subjected to worst-case minimum, maximum, and open circuit voltage of the flight vehicle power source.
- **Gyro Input Rate Limits. (S).** Gyro input rate limits shall be specified and meet range safety performance requirements. The IMU shall not produce false position data as a result of exceeding the specified input rotation rate limits during expected and non-nominal flight conditions.
- **Accelerometer Limits. (R) (A).** Acceleration input rate limits shall be specified and meet range safety performance requirements. The IMU shall not produce false

position data as a result of exceeding the specified acceleration measurement limits made by accelerometers during expected and non-nominal flight conditions.

- **Navigation Data Validity (R) (A) (D) (L) (S) (M) (Q).** IMU components shall be designed to prevent a single failure from producing out-of-specification position data unless there are quality indicators available in real-time that can identify any suspect data. This requirement applies to all dynamic conditions of the vehicle and the full range of environments imposed upon the vehicle.
- **State Vector (A).** RTS components shall provide a state vector that meets range safety performance requirements under all dynamic conditions of the vehicle while under Range Safety control.
- **Data Rate (S).** The state vector or any raw instrument data that is used for Range Safety tracking purposes shall be updated at a rate that supports Range Safety Requirements.
- **Delay Time (L).** The RTS components delay from end of measurement to state vector output on the downlink shall support Range Safety data latency requirements.
- **Measurement Set (M) (Q).** RTS components shall provide RF downlink data to support performance criteria required by each individual range.
- **Warm-up Time (A) (L).** The maximum time required after application of power to the IMU for the component to reach required accuracy shall support pre-flight timelines.

2.3.6 Radio Frequency Downlink Performance Requirements (R) (M) (Q) (S)

The RF downlink and data transfer system shall be capable of providing the required tracking performance data during the period of Range Safety responsibility for nominal and non-nominal vehicle flight.

- **Generation of Interfering Signals (R).** RF downlink spectral characteristics shall not generate interference that affects the Flight Termination System or other safety critical systems.
- **Data Rate (S).** The RF downlink system shall provide state vector data at a rate that supports Range Safety destruct criteria.
- **Delay Time (L).** The RTS components delay from end of measurement to state vector output on the downlink shall support Range Safety data latency requirements.
- **RF Downlink Characteristics (R).** The TM downlink characteristics shall provide the required data to support the performance requirements of this document.
- **Measurement Set (M).** The downlink system shall provide the required measurements of this document within the required update (sample) rate.

2.3.7 Airborne Coupled Inertial Measurement Unit/Global Positioning System Performance Requirements (R)(I)(M)(A)(S)(L)(Q)

The coupled IMU/GPS shall meet all operational requirements and specifications from acceptance testing through the end of Range Safety responsibility. These requirements are in addition to those listed in Sections 2.3.2 and 2.3.5.

- **Raw GPS Data. (R) (I) (A) (Q).** For coupled systems that employ blended positions, the GPS derived state vector shall be provided on the telemetry downlink. The GPS performance, data format and content shall meet the requirements of Section 2.3.2.
- **Quality Indicator (R) (I) (A) (Q).** For coupled systems that employ blended solutions, the blended output shall include a data quality indicator that shows correspondence between the raw GPS position estimate and the blended position estimate.
- **Stand-alone Observability. (R) (I) (A) (Q).** For coupled systems that employ blended solutions, the design shall make it possible to individually disable the GPS and the IMU in order to meet the test requirements of Tables A3-3f and A3-4f.
- **Independence. (I).** For coupled systems, the accuracy of GPS measurements and the GPS stand-alone position estimate shall be unaffected by failures and/or loss of precision in the IMU. This requirement does not address the case in which an IMU failure causes IMU-aided GPS tracking loops to lose lock on satellites. This requirement assures that an IMU failure cannot cause the GPS receiver to process or report incorrect pseudo-range or pseudo-range rate. Additionally, for systems that provide a blended solution, loss of the GPS input shall not cause the blended solution to report out-of-specification position data.

2.3.8 Airborne Global Positioning System Translator With Transmitter Performance Requirements (R) (I) (M) (A) (S) (L) (Q).

- **Maximum Dynamic Range (R) (A).** The translator shall function within its performance specification when subjected to the minimum and maximum RF L-band input.
- **Input Voltage (R) (A) (L).** The translator shall function within its performance specification when subjected to worst-case minimum and maximum circuit voltage of the flight vehicle power source. The translator shall not be damaged by the application of worst-case open circuit voltage of the flight vehicle power source.
- **Immunity to Interfering Signals (R).** The translator shall demonstrate that it meets all Range Safety required performance parameters when subjected to radiated or conducted emissions from all flight vehicle systems and expected external ground transmitter sources. In addition, components shall not radiate or conduct electromagnetic interference to flight termination system or vehicle components that would degrade the performance of those components below specification.
- **Delay Time (L).** The translator delay from L-band input to generation to RF downlink shall support the overall Range Safety data latency requirement.
- **Warm-up Time (A) (L).** The maximum time required after application of power for a translator to stabilize and perform within specification shall support pre-flight timelines.
- **Generation of Interfering Signals (R).** RF downlink spectral characteristics shall not generate interference that affects the FTS or other safety critical systems.
- **RF Downlink Characteristics (R).** The TM downlink characteristics shall provide the required data to support the performance requirements of this document.

2.4 RTS Ground Support and Monitoring Equipment Requirements

If required, ground support equipment shall be capable of processing and displaying critical Range Safety data to ensure the RTS is performing within specification.

This page intentionally left blank.

CHAPTER 3

PERFORMANCE REQUIREMENTS VERIFICATION-TEST

This chapter provides the performance requirements verification methods for the Range Tracking System (RTS). The RTS includes all vehicle components, systems, and subsystems necessary to provide range safety tracking data, RF downlink, and the range's support equipment that receives, transfers, processes, and displays the safety-related information. These verification methods are intended to validate the top-level range safety performance requirements described in Section 1.3. Specifically, they provide confidence that critical support capabilities will be maintained during applicable operating and non-operating environments. It is imperative that the range user coordinates with the ranges as early as possible to define the appropriate verification requirements. This will ensure that program schedules include hardware, software, and other provisions as necessary to conduct required verifications of RTS components and systems and minimize schedule and cost impacts. Verification criteria are contained in Appendix A.

3.1 Certification Process. (R) (I) (M) (A) (S) (L) (Q)

The process flow described in Figure 3-1 represents a base-line methodology to be used to certify RTS components. This process shall be tailored for each individual application to ensure that safety performance criteria are met throughout flight. The expected verification flow is described Figure 3-1 below; explanations of this process are also described in Appendix A.

3.1.1 Development Testing

Data generated during development testing can be used to supplement or replace other safety required performance testing. Development testing used to demonstrate compliance to safety requirements shall be tailored to ensure the data obtained shows that the required RTS performance is satisfied.

3.1.2 Qualification Testing

Qualification testing shall validate that safety requirements will be met throughout range safety responsibility. Safety performance parameters shall be validated under flight conditions including environmental exposure and functional performance that represent actual flight operation. Qualification testing shall demonstrate level and duration margin over flight environments and acceptance testing.

3.1.3 Acceptance Testing

Acceptance testing shall demonstrate that a flight unit can withstand flight environments, is a representative sample of the qualification unit, and is free of workmanship defects.

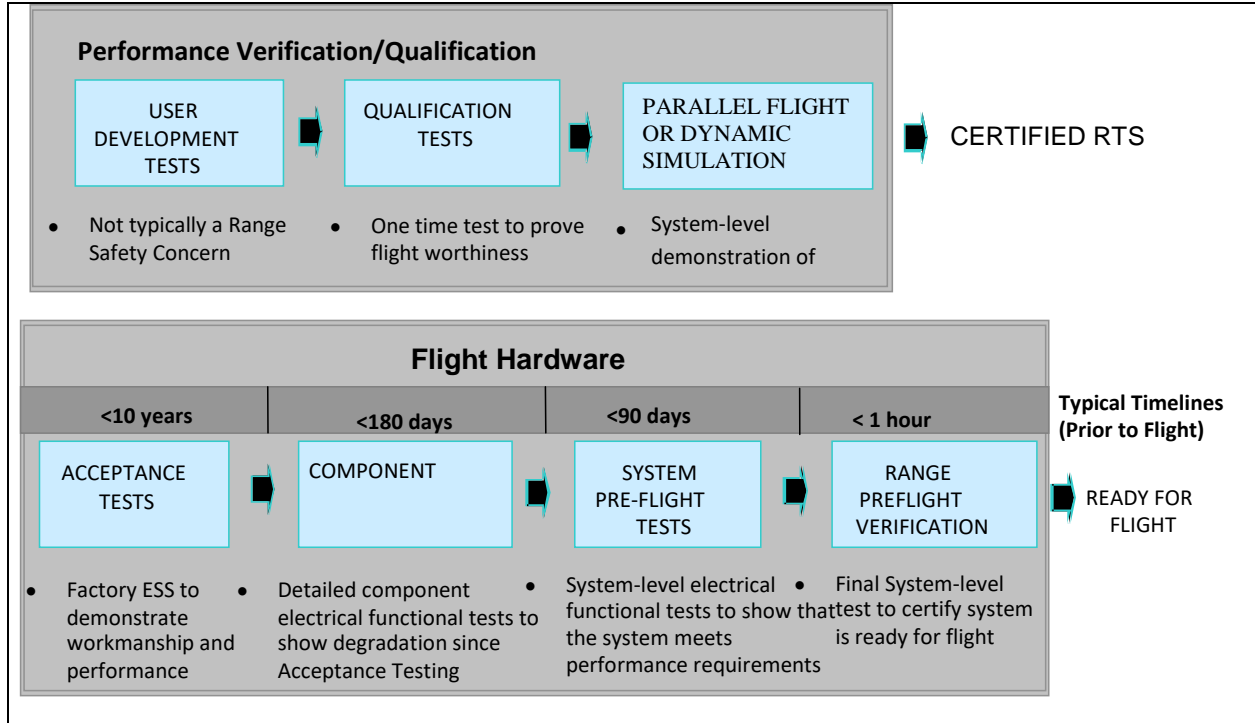

Figure 3-1. Performance Verification Qualification Process Flow

3.1.4 Component Functional Verification

RTS components shall undergo functional testing to ensure that they meet the safety performance requirement. If a significant amount of time has elapsed since acceptance testing or the last functional test, these tests shall be re-performed.

3.1.5 Preflight Tests

The entire RTS shall be tested prior to flight certification to ensure it meets all safety performance requirements after it is integrated into the vehicle system and is in the final launch configuration.

3.1.6 Functional Tests

Functional tests shall be performed during all applicable qualification, acceptance, and preflight testing to demonstrate that all RTS components will perform as required from the beginning of mission to the end of range safety responsibility.

3.1.7 Dynamic Simulation

To demonstrate tracking performance, a dynamic simulation shall be performed to ensure the tracking system will meet range safety performance criteria throughout flight.

3.1.8 Parallel Flight Tests

Demonstration of range safety performance requirements shall be validated by flight data. Parallel flight test certification data shall be based on at least three flights.

3.1.9 Reuse Testing

Reusable RTS flight hardware shall meet all range safety required performance parameters when subjected to repetitive non-operating and operating environments.

3.1.10 Special Tests

Unique applications not addressed in this document shall be tested to demonstrate compliance with all safety performance requirements.

3.1.11 Reference Functional Tests

These tests shall include a minimum set of critical parameters to validate unit functionality during environmental exposure. Reference functional tests shall be performed during non-operating, qualification, and acceptance environmental testing.

3.2 Component Performance Verification Tests (R) (I) (M) (A) (S) (L) (Q)

Range safety critical performance requirements, requiring test verification, can be demonstrated during development, qualification, range certification, range pre-launch, subsystems, and systems tests. These tests shall include status-of-health tests that are indicators of test unit health. Component performance test requirements are shown in Tables 3-1, 3-2, 3-3, and 3-4.

This section contains common test requirements to allow an RTS component to be used on a wide variety of applications and ranges. The applicability of the following requirements to a specific component is described in Tables 3-1, 3-2, 3-3, and 3-4. Specific recommended test solutions are referenced in the individual component test matrices in Appendix A. The specific testing required satisfying minimum safety requirements shall be determined during the tailoring process.

3.2.1 Product Examination

Each component shall be subjected to a product examination to identify manufacturing defects not detectable during performance testing.

3.2.2 Reserved

3.2.3 Reserved

3.2.4 Non-Operating Environmental Tests

Each tracking component shall demonstrate the capability to meet all critical safety performance requirements after being subjected to storage, transportation, installation, and other pre-launch environments.

3.2.5 Qualification Operating Environmental Tests

Qualification Tests shall be performed to ensure the suitability of the design to reliably operate and to provide expected results during and after exposure to physical environments experienced during acceptance testing and flight. Unless otherwise specified, qualification tests shall be run using sufficient margin (e.g. levels and duration) to account for uncertainties in flight environments, as well as, unit-to-unit production variability.

3.2.6 Acceptance Operating Environmental Tests

Acceptance Tests on flight hardware shall be conducted to demonstrate that each production end item meets safety performance requirements and to reveal production and workmanship inadequacies.

3.2.7 Component Test Requirements

RTS and RF downlink component testing shall be performed to demonstrate that critical range safety performance requirements will be met throughout range safety responsibility.

TABLE 3-1. RADIO FREQUENCY ACCEPTANCE TEST MATRIX					
TEST	TEST REQUIREMENT	QUANTITY TESTED			
		CABLE	COUPLER	Antenna L-Band	Antenna RF Downlink
Product Examination	3.2.1	100%	100%	100%	100%
Functional Tests	3.1.6	100%	100%	100%	100%
Reference Functional Test (a)	3.1.11		100%	100%	100%
Operating Environmental Tests	3.2.6		100%	100%	100%
Product Examination	3.2.1		100%	100%	100%

(a) Performed during operating environmental tests.

TABLE 3-2. RADIO FREQUENCY SYSTEM QUALIFICATION TEST MATRIX

TEST	TEST REQUIREMENT	Coupler Quantity	RF Downlink Quantity	L-band Antenna Quantity
		1	1	1
Acceptance	ACCEPTANCE TEST MATRIX	X	X	X
Functional Tests	3.1.6	X	X	X
Reference Functional Test (a)	3.1.11	X	X	X
Non-Operating Environmental Tests	3.2.4	X	X	X
Operating Environmental Tests	3.2.5	X	X	X
Functional Tests	3.1.6	X	X	X
Product Examination	3.2.1	X	X	X

(a) Performed during operating environmental tests.

TABLE 3-3. RADIO TRACKING SYSTEM AND DOWNLINK COMPONENT ACCEPTANCE TEST MATRIX

TEST	TEST REQUIREMENT	QUANTITY TESTED
Product Examination	3.2.1	100%
Functional Tests	3.1.6	100%
Reference Functional Test (a)	3.1.11	100%
Operating Environmental Tests	3.2.5	100%
Product Examination	3.2.1	100%

(a) Performed during operating environmental tests.

**TABLE 3-4. RADIO TRACKING SYSTEM AND DOWNLINK COMPONENT
QUALIFICATION TEST MATRIX**

TEST	TEST REQUIREMENT	QUANTITY TESTED
		1
Acceptance	ACCEPTANCE TEST MATRIX	X
Functional Tests	3.1.6	X
Reference Functional Test <i>(a)</i>	3.1.11	X
Non-Operating Environmental Tests	3.2.4	X
Operating Environmental Tests	3.2.5	X
Functional Tests	3.1.6	X
Product Examination	3.2.1	X
<i>(a)</i> Performed during operating environmental tests.		

CHAPTER 4

PERFORMANCE REQUIREMENTS VERIFICATION-ANALYSIS

This chapter provides the analysis criteria to verify performance requirements. Analyses are used to supplement or replace testing described in Chapter 3 as a method for range safety performance verification. Detailed analysis criteria are contained in Appendix A. *The performance validation criteria of this chapter shall be tailored to develop a range safety approved tracking source.* Depending on the tracking configuration and vehicle hazards, different levels of analytical performance verification will be required. Analyses required by Range Safety may or may not have to be submitted for review and approval depending on factors such as risk level, component heritage, and range user experience. Documentation of analyses results may be required and should be placed in the range tracking system report in accordance with tailoring agreements as discussed in Chapter 5.

4.1 Range Tracking System General Analysis Requirements (R) (O) (A) (S) (L)

RTS performance requirements, including components and methods of attaching fittings or installing the system, shall be validated by analysis, inspection, test or similarity. When analyses are used, they shall certify that the complete system and individual components function within the required performance parameters when exposed to environmental levels that exceed the maximum predicted flight levels during their service life.

4.2 Range Tracking System Failure Analysis (R) (O) (A) (S) (L)

Any failures occurring during testing or flight shall be identified and corrected if they can adversely affect range safety required performance criteria.

4.3 Range Tracking System Similarity Analyses (R) (O) (A) (S) (L)

RTS components that utilize test data or analyses from a similar component shall be analyzed to ensure that any differences in hardware/software configuration will not result in violation of any required range safety performance parameter during flight.

4.4 Range Tracking System Reliability Analysis (R)

The range user shall provide the predicted reliability of the RTS throughout the period of range safety responsibility for loss of data and probability of an RTS to produce unverifiable out-of-specification state vector data.

4.5 Range Tracking System Energy/Power Analysis (R)

RTS power sources shall be analyzed to validate that their electrical performance will meet all performance requirements throughout the period of range safety responsibility. This requirement includes power source usage for pre-flight activities and contingencies for operational delays.

4.6 Range Tracking System Radio Frequency Link Analysis (R)

RTS and RF downlink analyses shall be accomplished to ensure that the RTS will meet all performance requirements throughout the period of range safety responsibility.

4.7 Re-Use

Analyses shall be performed to demonstrate that reusable RTS flight hardware will meet all Range Safety required performance parameters when subjected to repetitive non-operating and operating environments.

4.8 Prior Flight History

RTS components that utilize prior flight history to reduce/eliminate test or analysis verification requirements shall be analyzed to ensure that any differences in hardware/software configuration will not result in violation of any required range safety performance parameters during flight.

4.9 Range Tracking System Radio Frequency Environment Analysis (R)

Launch vehicle and payload systems shall be analyzed to ensure that the RTS will meet range safety performance criteria in the expected RF environment.

4.10 Breakup Analysis (R) (A)

A breakup analysis shall be performed, where applicable, to ensure the RTS will meet all range safety performance requirements during non-nominal vehicle flight.

4.11 Dynamic Simulation Analysis

Where applicable, dynamic simulation testing shall be performed to demonstrate that the GPS system will meet critical performance requirements throughout range safety responsibility. Anticipated dropouts or periods of out-of-specification performance shall be analyzed and submitted to Range Safety to incorporate into mission rules.

4.12 Independence Analysis

An analysis shall be performed to ensure that the minimum required tracking sources meet the independence requirement.

4.13 Failure Modes and Effects Criticality Analysis (R) (I) (M) (A) (S) (L) (Q)

An analysis shall be performed to demonstrate that there are no undetectable real-time failure modes within the RTS that can produce an out of specification state vector.

CHAPTER 5

PERFORMANCE REQUIREMENTS VERIFICATION DOCUMENTATION

General (Q). Documentation is necessary to demonstrate compliance with critical performance requirements. Except when specifically required, the items described in this section represent a potential list of documentation that may be required by some ranges. The extent of documentation and control will depend on the risk, uniqueness of the application, component/system heritage and range user experience. Detailed requirements for data submittals will be determined during the tailoring process.

5.1 Range Tracking System Component Test History (R) (Q)

- A test history shall be maintained for each RTS component.
- The test history shall be made available to Range Safety upon request.

5.2 Reporting In-Flight Anomalies (R) (Q) (A) (S) (L)

A failure analysis report shall be submitted to Range Safety for review and approval for any in-flight failure of an RTS component to meet a required range safety performance requirement or out-of-specification condition.

5.3 Range Tracking System Radio Frequency Link Analysis (R) (Q)

The TM downlink RF link analysis shall be submitted to the range for each mission.

5.4 Radio Frequency Downlink Measurement List (M) (Q)

Range users shall submit an RF downlink measurements list with sufficient time to allow the range personnel to review and develop ground processing capability as needed.

5.5 Range Tracking System Compliance Checklist

The range user shall document compliance with the range safety required performance specifications contained in this document.

5.6 Other Documentation

Documentation may be required to demonstrate compliance to performance requirements. The need for any documentation will be determined on a case-by-case basis.

This page intentionally left blank.

APPENDIX A

SUGGESTED APPROACHES FOR MEETING PERFORMANCE REQUIREMENTS

The suggested approaches provided in this section are intended to satisfy the following objectives:

- a. Aid range users in developing an RTS that may be used on multiple ranges for most vehicle configurations. **Note:** For specific vehicle applications, these requirements should be modified to reflect program objectives while meeting minimum safety requirements.
- b. Help Range Safety and range users in evaluating a potential RTS against expected values. Values that are not consistent with expected results can be flagged and evaluated to ensure that there is no safety concern generated.
- c. Aid Range Safety and range users in implementing lessons learned.
- d. Provide an appropriate level of detail necessary for contractual efforts. The recommended solutions in this appendix act as “place holders” where experience has shown that misunderstandings often occur if a detailed requirement is not levied. It is expected that contractual requirements will utilize the recommended solutions of Appendix A or specifications that reflect a similar amount of detail. This level of detail is critical to avoid costly out-of-scope contractual changes or prevent inadvertently overlooking a critical technical requirement.
- e. Appendix A design and test solutions, though recommended, have different levels of criticality. Specifications that use the word “*shall*” require careful consideration during the tailoring process; whereas, design and test solutions that use the word “*should*” represent current industry practices and can be implemented in several ways.
- f. Range Safety has final decision authority in determining whether a range user proposed solution meets a particular safety performance requirement.

A2.1 Range Tracking System General Performance Requirements (R) (I) (A) (S) (L) (Q) (M)

Software and hardware shall be placed under configuration control or an equivalent methodology, which ensures that the RTS will meet range safety performance requirements. If a Commercial-Off-The-Shelf (COTS) model (i.e. limited or no configuration control) is desired, each requirement of this document must be addressed against this methodology to ensure compliance to range safety performance requirements. The following methods represent options, which may meet configuration control requirements:

- a. Qualify a design (hardware and software) to the performance requirements of this document. Production flight hardware is built to the identical parts, materials and processes as that used for the qualification unit. The production units are placed under configuration control and Range Safety shall approve any changes.

- b. A lot of production hardware can be procured where the lot is placed under configuration control (i.e. same parts, materials, software and processes within the lot). The lot would then be qualified to the requirements of this document. The next lot, which may not be the same configuration as the last qualified lot, would undergo another qualification and treated independently of any other production lot. This method would also use the same conditions as described above, but at the lot-level versus a generic design.
- c. This method assumes that each RTS component is a unique configuration (i.e. no configuration control). Each RTS flight hardware component would undergo an individual qualification to demonstrate compliance to the requirements of this document. **Note:** This type of testing could create reliability concerns associated with overstressing flight hardware.
- d. The uncertainties in performance from an RTS component not under configuration control can be taken into account in the mission rules to ensure that minimum public safety criteria is met. For this method, RTS flight hardware must be tested to ensure it meets the performance requirements of this document, which may require additional testing on flight units. However, much of the reliability testing could be reduced/eliminated at the increased risk to mission assurance (see B2.1.4).

A2.1.1 Range Tracking System Software and Firmware (R) (A) (S) (L) (Q)

Software and firmware that was certified to the required performance verification requirements of Chapter 3 and Chapter 4, shall be placed under configuration control and not altered without Range Safety approval. Changes in software and firmware shall be submitted to Range Safety to allow formulation of a jointly developed plan to re-certify the software. For COTS models, see 0 for configuration control options. The following requirements shall be considered regardless of configuration control methodology:

- a. All software and firmware used in an RTS should be subjected to independent verification and validation (IV&V) in accordance with established standards.
- b. Approval should be obtained from Range Safety prior to production of the component or system.
- c. Once approved, any modification shall be validated in the same manner and approved by Range Safety prior to further production.
- d. Changes in software shall be tested and/or analyzed to verify that the new software will meet range safety performance requirements. In general, some level of qualification and acceptance re-testing shall be performed to certify any new software.

A2.1.2 RTS Software and Component Failure Modes (A) (S) (L) (R)

a. No single point failures should exist within any RTS system, component or piece-part that could produce out-of-specification state vector data. If this failure condition exists, a data flag should be provided in real-time to notify the RSO that the data cannot be relied on. If undetectable failure modes exist, then the probability of occurrence shall be calculated and

factored into the mission rules. The RTS shall perform adequately during all planned and unplanned vehicle dynamic conditions.

b. The severity and probability of such failure modes may lead to more stringent mission rules or a requirement for additional sources of tracking.

c. There should be no single point of failure that results in the loss of all sources of tracking. However, in most cases, passive (i.e. no active electronic circuitry) RF components do not need to be redundant to meet this candidate requirement.

d. This requirement is more easily met by providing the required number of sources using different phenomenology. Phenomenology refers to the manner, in which, the tracking data is derived (e.g. Ring Laser Gyros, GPS, transponder, inertial stable platform, etc). It may also be possible to use of the same phenomenology with different manufacturers to elevate common-cause failure concerns.

A2.1.3 Sample Rate (S)

It may not be necessary to maintain a fixed sample rate throughout flight of a single mission. However, the planned sample rate(s) from mission-to-mission should not change. A sample rate that supports an instantaneous impact prediction (IIP) and present position update rate of 10 samples per second (sps) will meet most vehicle and range applications. Some ballistic vehicle programs may be required to use higher sample rates (i.e. 20 sps) depending upon target points. For RTS sources that use slow sample rates (i.e. greater than 2 sps), each of the required sources should provide its state vector solution as close to the other as possible.

A2.1.4 Range Tracking System Reliability (R)

Compliance with the tailored reliability solutions of Appendix A (i.e. requirements with a footnote (R)) shall be demonstrated to meet the intent of the numerical reliability requirements. A design reliability should also be calculated to show compliance with this requirement.

a. System, in this context, includes all elements from the vehicle receive antenna to the TM downlink transmission. **Note:** For translator-based systems, the system would also include the TM receiving station and the Ground Translator Processor (GTP).

b. A reliability analysis should be performed to demonstrate that reliability requirements are met in the design of the components and/or system. Guidelines are set forth in MIL-STD-785 and MIL-HDBK-217.

A2.1.5 Range Tracking System Design Life (R) (A)

Range Safety shall be notified when the operating and storage life of an RTS component expires prior to launch approval.

a. Operating and storage life shall be specified for electrical components.

b. The operating and storage life for electrical components starts at completion of the initial acceptance test.

c. If required, expired component retest should be determined by mutual agreement between Range Safety and the range user.

A2.1.6 Range Tracking System Electrical and Electronics Subsystems

A2.1.6.a Range Tracking System Piece/Part Selection Criteria (R) (A)

- (1) As a reference, design and test requirements outlined in ELV-JC-002D (Parts, Materials, and Processes Control Program for Space Launch Vehicles, 20 May 1992, point of contact (POC): Los Angeles Air Force Base (AFB), California) are often used as a baseline to tailor a customized parts program. In general, piece-parts will have some level of screening (e.g. electrical functional tests) performed as part of vendor acceptance. In addition to electrical functional tests, it is strongly recommended that a Particle Impact Noise Detection (PIND) test be performed on 100percent of all cavity devices. The level of parts screening will depend on the range user desired mission reliability, dynamic environments, and problems encountered during testing or flight.
- (2) Addition, subtraction, or replacement of piece/parts within an RTS component often requires a specific analysis with Range Safety approval. **Note:** This requirement is tied to the configuration control requirements of paragraphs 2.1.1, A2.1.1 and B2.1.1.

A2.1.6.b Range Tracking System Voltage and Current Parameters (R) (A)

- (1) The input voltage range of each component shall be specified. The current in the stand-by and operating modes should be noted in the specification to be used for in-family verification during testing.
- (2) The components shall meet critical performance requirements of this document at the minimum and maximum specified voltage levels.
- (3) The components should not be damaged because of low or fluctuating input voltage.

A2.1.6.c Transient Voltage Generation (R)

All RTS and vehicle system interface components containing reactive elements such as relays, electrical motors, or similar devices that are capable of producing transient voltages should be provided with suppression circuitry to prevent interference or damage to other RTS components.

A2.1.6.d Range Tracking System Voltage Protection (R)

- (1) RTS components should not be damaged by the application of the open circuit voltage of the power source. Typically, 45 VDC is considered a worst-case condition.
- (2) This voltage should be applied in both normal and reverse polarity modes to the component power input ports for a period not less than 5 minutes.

A2.1.6.e Range Tracking System Transient Power Susceptibility (R)

- (1) Any power transfer switch and/or assembly shall not change state as a result of input power dropout, typically for a period of 50 milliseconds minimum.
- (2) GPS shall be capable of meeting rapid re-lock requirements after experiencing a power dropout of no more than 50 milliseconds.
- (3) Relays should be designed and/or selected to prevent chatter.
- (4) IMU's shall be capable of meeting range safety performance requirements after being subjected to a power dropout of no more than 50 milliseconds.

A2.1.6.f Range Tracking System Continuity and Isolation (R)

- (1) The resistance from each pin-to-pin and common return and case ground should be specified. This value is used as status-of-health indicator during bench testing.
- (2) Measurements that are polarity sensitive, such as those containing diodes, should be identified.
- (3) Significant pin-to-pin measurements should be included where their inclusion will provide meaningful data relative to the reliability of the component
- (4) Component case ground should be isolated from the common return with an isolation of at least 10 kohms with a goal of 2 megohms.

A2.1.6.g Range Tracking System Circuit Isolation (R)

- (1) RTS circuitry should be shielded, filtered, grounded, or otherwise isolated to preclude energy sources such as electromagnetic energy from the range or launch vehicle causing interference that would inhibit the functioning of the system.
- (2) There should be only one interconnection (single point ground) with other circuits.

A2.1.6.h Range Tracking System Testability (R) (A) (M) (S) (Q) (L)

RTS and associated ground support and monitoring equipment design shall provide the capability to perform the testing described in the RTS Test requirements section of this document.

A2.1.6.i Range Tracking System Self-Test Capability (R)

- (1) If the component uses a processor, it should have the capability to perform a self-test (error detection) at power ON.
- (2) When possible or feasible, the results of the self-test should be an output function and observable from the vehicle RF downlink.
- (3) The execution of a self-test should not inhibit the function of the unit.

A2.1.6j Range Tracking System Wiring (R)

Wiring shall maintain integrity and provide the necessary signals, power and shielding to allow the RTS to function within its specification from vehicle liftoff to the end of range safety responsibility.

- (1) The insulation resistance between the shield and conductor should be greater than 2 megohms at 500 Vdc minimums. **Note:** COTS hardware may be as low as 1 megohm.
- (2) Wiring and harness should be capable of withstanding 1500 VAC root mean square (RMS) 60 Hz at sea level pressure between mutually insulated points and the case or housing.
- (3) Wire should be of sufficient size to adequately handle 150 percent of the design load.
- (4) Wires and cable should be given support and protection against abrasion.

A2.1.6.k Range Tracking System Electrical Connectors (R)

RTS connectors shall maintain integrity while providing the necessary signals/power to allow the RTS to function within its specifications from vehicle liftoff to the end of range safety responsibility.

- (1) RTS connectors designed in accordance with the requirements of MIL-C-38999J or equivalent have proven to be very reliable.
- (2) Plug and socket type connectors are suggested.
- (3) Outer shells of connectors should be made of metal.
- (4) Connectors should be of the self-locking type or lock wiring should be used to prevent accidental or inadvertent demating.
- (5) Connector design should ensure that the shielding connection is complete before the pin connection.
- (6) Source circuits should terminate in a connector with female contacts.
- (7) Connectors relying on spring contact should not be used.
- (8) The mated connectors should withstand an axial pull on the cable or harness of at least 30 lb for a minimum of 1 minute.
- (9) Connectors should be capable of adequately handling 150 percent of the worst-case design load.
- (10) Connectors shall be designed to prevent electrical discontinuities (chatter) of more than 500 microseconds during operating environments such as shock and vibration.

A2.1.6.l Range Tracking System Power Sources (R)

- (1) RTS power sources should support the overall range safety reliability requirements.
- (2) Failure of a single power source shall not result in loss of all tracking data.
- (3) Power sources shall have the capacity to support the RTS power requirements throughout the period of range safety responsibility.
- (4) Power sources shall be capable of providing specification level voltage to the RTS during expected flight loads. Power source capacity time includes activation checks, pre-flight countdown checks, flight recycles and any necessary hold time. Sufficient

capacity should be available for 150 percent of the mission time for which Range Safety has responsibility. Mission time includes the minus count time starting when the RTS has switched to the final internal power configuration through normal flight.

- (5) Range Commander's Council (RCC) 319, Flight Termination Systems Commonality Standard, is a recommended source for battery reliability requirements.

A2.1.6.m RTS Power Source Monitoring Capability (R)

- (1) The voltage of each power source should be monitored within 2 percent accuracy.
- (2) Power sources requiring heating or cooling to sustain performance should have an RF downlink channel indicating the temperature of each power source.
- (3) The power source current should be monitored.

A2.1.7 Interference Protection (R)

a. The RTS and support systems should satisfy the following tailored requirements in all operational configurations (to include data traffic on any attached data cables) of MIL-STD-464 and MIL-STD-461E.

- (1) The RTS shall meet all performance criteria stated in this document when collocated with other electronic equipment that does not violate the tailored requirements above. As a minimum the RTS and accessories should comply with the following MIL-STD-461E requirements for Army Aircraft (Internal and external) except as noted: CE101, CE102, CE106, CS101, CS104, CS114, CS115, CS116, RE101 (Navy), RE102, RS101, and RS103. For RS103 the frequencies $L1 \pm 75$ MHz and $L2 \pm 75$ MHz shall be excluded. In addition, testing shall include any radiating source on the vehicle or ground that could cause interference.
- (2) Test setups and methods should be IAW MIL-STD-461E with the following exception for RE102: The remote antenna cable shall be zigzagged (sometimes called a serpentine pattern) vertically above and parallel to the ground plane on a non-conductive panel. The serpentine pattern should be constructed by first placing a length of cable at the bottom of the panel parallel to the ground plane and minimally 5 cm above it, and then reversing the direction of the cable run by 180 degrees each time a change of direction is required. At least five changes of direction are recommended. Individual segments of the cable are parallel and should be kept at least 5 cm apart. No coiling should be performed. The remote antenna should be located above the GPS receiver and in the same vertical plane as the GPS receiver. All other cables should be positioned IAW MIL-STD-461E.
- (3) Through experience, it has been found that if the RE102 cables are laid out per the specification, emissions can be shunted to ground and not detected. Therefore, we have tailored the RE102 remote antenna cable routing to represent a worst-case radiation configuration.
- (4) Vehicle L-band telemetry systems require careful consideration since problems have been experienced where the C/N_0 experienced significant degradation due to electromagnetic interference (EMI). L-band TM systems can cause loss of tracked satellites even when the TM center frequency is not located at the GPS center frequency.

- b. Triboelectrification, the buildup of a static charge on nonconductive surfaces (greater than 10^9 ohms) for vehicles flying through certain cloud formations with ice crystals, should be evaluated to ensure static discharge will not occur or degrade RTS performance.
- c. For weapon system tests that are tested in a GPS jamming environment, special consideration must be made to ensure that the GPS performance is not degraded. If possible, other sources of tracking should be used to supplement the GPS to ensure that the reliability requirements are met for the minimum number of required tracking sources. GPS tests for jamming are not included in this document and must be developed on a case-by-case basis during the tailoring process.

A2.1.8 System Delay Time (L)

An end-to-end delay time of less than 250 ms will meet most vehicle applications.

- a. For GPS receivers, this delay includes L-band reception to the GPS receiver state-vector output through the TM downlink and reception at a TM ground station.
- b. For IMU's, this delay includes IMU/guidance computer generation of a state vector, through the TM downlink and reception at a TM ground station.
- c. For differential GPS, the total delay time includes the total latency from receipt of airborne L-band signals, through the GPS receiver to the ground processing system and computation of the final state vector.
- d. For Translators, the delay includes L-band reception to the translator through the TM downlink and output of a state vector from the GTP.

A2.1.9 Independence (I)

Two RTS systems, which do not interface with one another, can be considered two independent sources of tracking. The use of shared components such as antennas and couplers between two GPS systems should be specifically evaluated for single failure points that could degrade tracking performance on both GPS sources. Validation of the independence requirement should be performed by analysis or test.

A2.1.10 Accuracy (A)

- a. The accuracy of the RTS shall remain within specification during worst-case dynamic conditions such as vibration and shock induced phase jitter: For most vehicle applications on the majority of ranges, an GPS C/A code derived state vector tracking data produces an acceptable accuracy without the use of differential GPS.
- b. Unplanned or non-nominal vehicle RTS performance shall be evaluated to ensure that the RTS does not provide false position state vector data during non-nominal vehicle flight. Breakup dynamic environments may be obtained from the FTS breakup analysis to determine if acceleration and velocity values exceed RTS specification limits. Another method to demonstrate, that the RTS will not produce false position data, is by successfully passing the test criteria outlined in paragraph A3.1.7 (Test 2). By comparing the breakup analysis expected environments with the threshold parameters described in paragraph A 3.1.7 (Test 2), a determination can be made of tracking capability during failure conditions.

c. For some space launch vehicles utilizing stressing flight trajectories the following 3σ parameters may be necessary to meet mission objectives:

- (1) When the range to the Instantaneous Impact Point (IIP) is less than or equal to 66,000 ft from the launch point:
 - Present position (PP) uncertainty, expressed as the square root of the sum of the squares (RSS) of the errors in the three orthogonal axes, shall not exceed 250 ft
 - Crossrange IIP uncertainty shall not exceed 330 ft.
 - Downrange IIP uncertainty shall not exceed 330 ft.
- (2) When the range to the IIP is greater than 66,000 feet ft from the launch point:
 - Crossrange IIP uncertainty shall not exceed 0.5 percent of the vacuum impact range.
 - Downrange IIP uncertainty shall not exceed 1.0 percent of the vacuum impact range.

A2.1.11 Quality/Confidence Indicators (R)(Q)

The RTS shall provide indications of system performance status. This data shall allow real time evaluation of the critical performance parameters. Quality indicators (flags) shall be made available for detectable events that result in out-of-specification state vector performance data.

A2.1.12 Number of Range Tracking System Sources

A minimum of two independent sources of tracking shall be provided from beginning of mission to the end of range safety responsibility.

A2.2 Range Tracking System Airborne Environmental Performance Requirements (R) (I) (M) (A) (S) (L) (Q)

a. RTS Component Maximum Predicted Environment (R) (A) (L) (S) (Q). The RTS shall be capable of functioning within specification when subjected to storage, transportation, installation, and flight environments.

- (1). An analytical approach for determining RTS component maximum predicted environment (MPE) levels such as shock, thermal, and vibration should be developed by the range user and provided to Range Safety for review and approval.
- (2). The analytical approach should use existing flight data from other similar vehicles (if available), analysis, computer modeling, and subsystem testing such as bracket and truss vibration testing.
- (3). When measured data is not available, there should be sufficient conservatism to account for analytical uncertainty and flight-to-flight variations. Typically, if there are fewer than three existing flight data samples, a minimum 3-decibel (dB) margin for vibration, 4.5-dB for shock, and 11°C for thermal should be added to the analytical environment to obtain the predicted MPE. For highly critical safety applications, a 4-dB vibration margin should be used.
- (4). The predicted MPE should be validated by actual environmental load measurements taken during flight of at least three vehicles. Measurements should be taken in locations that reflect RTS hardware locations. If all data does not correlate then

additional load measurements on additional vehicles should be taken. **Note:** Vibration predictions can sometimes yield high peaks with narrow bandwidths. The energy contributed to the device by narrow band peaks may be negligible; however, attempting to envelop them during qualification and acceptance testing can result in nonrealistic overtest of flight hardware. High level narrow-band peaks may be reduced using the following procedure:

STEP 1: Identify peak to be clipped

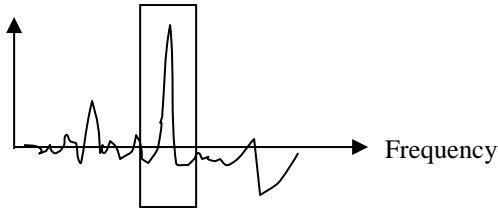

STEP 2: Locate center frequency of the peak and multiply it by 10% ($0.10X F_c$)

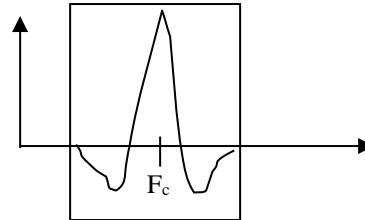

STEP 3: Determine the value on the curve where the width (bandwidth) is equal to $0.10 X F_c$

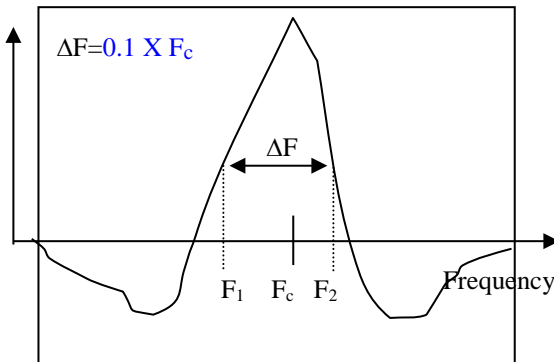

STEP 4: Clip the curve at the $0.10 X F_c$ bandwidth level

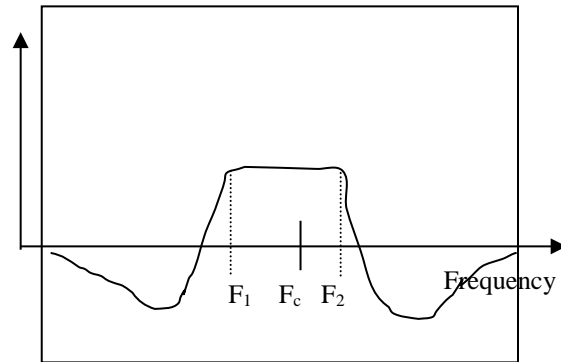

STEP 5: Determine the amount of the peak clipping by measuring the amplitude to the clipped level. If it is greater than 3 dB proceed to Step 6. If not, this becomes the final value.

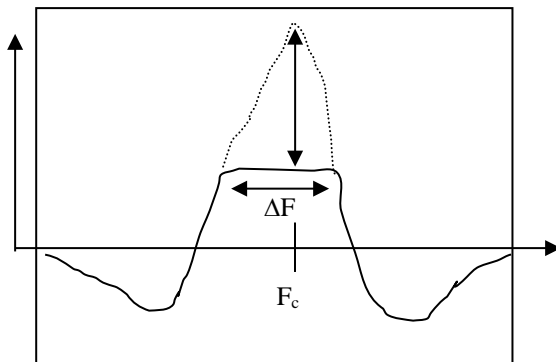

STEP 6: The final reduction of the peak is the lesser of the peak clipped curve in Step 4 or a 3 dB reduction from the peak. **Note:** A curve can be clipped no more 3 dB.

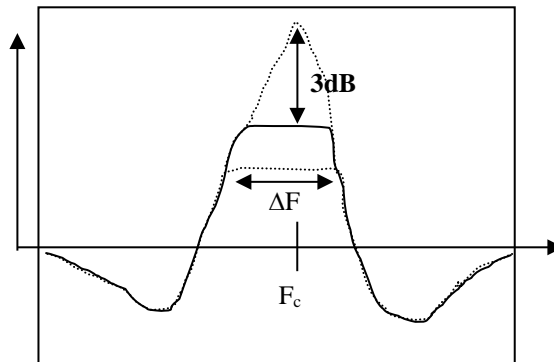

Figure A3-1. Narrow-Band Vibration Peak Clipping Procedures

b. RTS Component Random Vibration Environment

- (1). RTS components shall be designed to survive random vibration environments that are 6-dB above the MPE level or 12.2 Grms, whichever is greater. The 12.2 Grms qualification value allows for 6 dB of margin over the 6 Grms minimum workmanship screening during acceptance testing.
 - (2). The typical design duration:
 - (a) Three times the expected flight exposure time or 3 minute per axis, whichever is greater, for qualification
 - (b) A flight exposure time or 1 minute per axis, whichever is greater, for acceptance
 - (c) A minimum frequency range from 20 to 2000 Hz is expected.
- c.* RTS Component Acoustic Noise Environment

- (1). RTS components shall be designed to survive acoustic noises that are 6-dB above the MPE level or a minimum 144-dB overall sound pressure for acoustic, whichever is greater.
- (2). The minimum expected design duration should meet the following criteria:
 - Three times the expected flight exposure time or 3 minutes; whichever is greater, for qualification.
 - The flight exposure time or 1 minute, whichever is greater, for acceptance.

d. RTS Component Shock Environment.

- (1). RTS components shall be designed to a margin of 6 dB above the MPE level.
 - (2). The duration should simulate the actual shock environment.
 - (3). A minimum frequency range from 100 to 10,000 Hz is expected.
 - (4). The minimum number of expected shocks is 3 shocks per axis for each direction, positive and negative, for a total of 18 shocks.
- e.* RTS Component Acceleration Environment

- (1). Unless otherwise specified by Range Safety, RTS components shall be designed to two times the MPE level in each direction.
- (2). The minimum duration for acceleration should be three times the expected exposure for each axis.

f. Other RTS Component Environments. Other environments that may be applicable to RTS components are humidity, salt fog, dust, fungus, explosive atmosphere, thermal vacuum, sinusoidal vibration, and other non-operational environments.

g. RTS Environmental Survivability (R) (A) (L) (S) (Q). RTS components including methods of attachment, mounting hardware, and cables and wires shall be designed to function within performance specifications when exposed to environmental levels that exceed the ground transportation, pre-flight processing, checkout, and flight through end of range safety responsibility.

h. RTS Shock and Vibrational Mounted Isolation Systems (R) (A) (L) (S) (Q).

Shock and vibration isolation systems shall perform within specification to ensure operational survivability of flight hardware. Flight isolator natural frequency and amplification specifications shall demonstrate repeatable performance as those isolators used for qualification.

- (1). Shock and/or vibration isolation systems include vibration mounts, foam rubber, rubber washers or gaskets that are essential to ensure the induced environmental survivability of a component.
- (2). The shock and/or vibration isolator should be designed and controlled to the following criteria: Isolator characteristics are usually specified in the source control drawing.
 - The allowable variation of the resonant amplification factor (Q) and isolator resonant frequency (f_n) about nominal values should be stated in all three principal axes.
 - When elastomeric isolators are used, they should be designed and manufactured to minimize the variations in the f_n and Q.
 - When metallic isolators such as spring or steel mesh types are used, they should be in a container to prevent contamination.
- (3). All flight isolators shall be tested to ensure that their performance characteristics support component-level environmental requirements.

A2.3 Airborne RTS Support Systems

A2.3.1 Airborne RTS Antenna System (R) (A) (L)

A2.3.1.1 Airborne RTS Antenna System General Performance Requirements (R) (A)

The range user shall provide an analysis describing anticipated dropouts in the L-Band reception and RF downlink.

A2.3.1.2 Airborne GPS Receive Antenna System (GPS Satellite to Launch Vehicle) (R) (A)

This system is used to receive L-Band signals (L1 and possibly L2) from GPS satellites and pass RF energy to the GPS translator or receiver.

- a.* The GPS receive antenna system (L-Band GPS satellite to vehicle) shall provide adequate gain over the radiation sphere to ensure that the GPS system provides uninterrupted state vectors from before lift-off through end of range safety responsibility. In addition to polarization and gain, antenna patterns should account for variations in phase noise and slope.
- b.* The GPS receive antenna system should provide a tracking solution using a 95 percent spherical antenna coverage.
- c.* The antenna system should typically display a voltage standing wave ratio (VSWR) of less than 2.0:1 when excited from a source with the same impedance as the planned cable

installation at the assigned frequencies across all environmental conditions. Antenna systems with a higher VSWR often require specific range safety consideration. The cause of the high VSWR should be identified and special design and/or test requirements may be imposed.

d. The antenna system passband design shall demonstrate margin over expected operational variations including doppler shift, flight hardware manufacturing tolerances and antenna performance variations due to temperature. The antenna system passband should also minimize the effect of interference from other transmitting sources. This may require the inclusion of filter traps.

e. Antenna systems should be designed to allow maximum physical separation throughout flight to allow viewing of satellite constellations that provide the required DOPs. This is especially a concern for vehicles that mask antenna coverage (e.g. large payload fairings) that only allow satellites in view from a limited angle.

f. Where dual GPS tracking systems are used as the only source of tracking, each GPS unit should utilize a different set of antennas at a 90 degree offset from each other (see independence requirement).

A2.3.1.3 Airborne RTS Transmit Antenna System (Vehicle to Ground) (R) (L)

This system is used to transmit (downlink) RTS data to ground receiving station(s). The RTS transmit system may share RF downlink antennas with the *vehicle* RF downlink system if neither system is degraded below their respective requirements.

a. The antenna system should display a voltage standing wave ratio (VSWR) of less than 2.0:1 when excited from a source with the same impedance as the planned cable installation at the assigned frequencies. Antenna systems with a higher VSWR may require specific Range Safety approval. The cause of the high VSWR should be identified and special design and/or test requirements may be imposed.

b. The antenna system should operate within required specifications with no arcing or damage, at twice the normal RMS and peak excitation power at any atmospheric pressure between 0.0001 and 760 Torr (mm. of Hg).

c. Passive components in the downlink antenna subsystem may be exempt from no single point of failure requirements. The diplexer required to couple a digital translator signal to an antenna that is also downlinking other signals has not yet been demonstrated. Reliability and spurious emissions should be carefully considered when analyzing a translator configuration employing a wideband diplexer. Attention should be given to possible desensitization of the L-Band components.

d. Antenna systems shall provide a 95 percent spherical coverage for closing the TM downlink.

A2.3.2 GPS Receiver General Performance Requirements

A2.3.2.1 General

- a. **Maximum Dynamic Range (R)(A).** The GPS receiver shall function within its performance specification when subjected to the minimum and maximum RF L-band input.
- b. **Input Voltage (R)(A)(L).** Typically, 22 to 45 VDC is considered a worst-case condition for power source variation.
- c. **Navigation Data Validity (R)(A)(D)(L)(S)(M)(Q).** This requirement shall be validated by analysis and test. The analysis should examine individual electronic piece-part failures and software vulnerabilities to ensure there are no failure modes that would produce undetectable real-time out-of-specification navigation data. Testing should exercise software and hardware capabilities by stressing the component to dynamic and environmental conditions described in Chapter 3.
- d. **Immunity to Interfering Signals (R).** Translator/receiver immunity to expected interfering signals from the range and flight vehicle should be specified as a function of tracking and signal acquisition levels (3dB reduction). Susceptibility to combinations of up to three out-of-band continuous wave signals should be specified (e.g. C-band, S-band and UHF). Range transmitter source data can be acquired through the applicable Range Safety Office.
- e. **State Vector (A).** For many vehicle applications on most ranges, standard C/A code tracking without differential GPS will meet safety performance tracking requirements. A higher degree of accuracy may be required in certain instances depending on numerous factors such as flight azimuth proximity to populated areas, sample rate, delay and vehicle dynamic capability (see paragraph A2.1.10). Most stringent vehicle trajectories can be met with a 100m and 0.3m/s 1σ present position accuracy. For missions requiring a more stringent accuracy, an increased accuracy must be provided or the mission may be limited (e.g. limiting trajectory) by safety constraints.
- f. **Data Rate (S).** Typically, an update rate of at least 10 samples per second will meet most mission requirements.
- g. **Delay Time (L).** For a ten sample per second output an RTS having direct line-of-sight to the downlink acquisition site, an airborne RTS component delay of 125 ms or less will typically meet most vehicles' tracking requirements. Additional delays will accrue in the range's data transfer, data processing and display subsystems.
- h. **Measurement Set (M)(Q).** Candidate examples of data in the RF downlink include; pseudo and delta pseudo range, DOPs, C/N₀, lock status, state vector, and satellite assignment.
- i. **Rapid Re-Lock Capability (L)(R)(A).** The re-lock time after loss of a satellite shall be specified and approved by the range. For most vehicle applications, one to two seconds is acceptable.
- j. **Time to First Fix (R)(A).** Time to first fix shall be specified and approved by the range especially for configurations that acquire the GPS signal after launch such as bomb-bay drop, canister, silo and submarine launched missiles. Unless special conditions exist, all vehicles shall have GPS acquisition that meets safety performance requirements prior to takeoff/liftoff.
- k. **De-Selection of Faulty Satellites (R)(A)(Q).** The receiver should have an inherent capability to identify and de-select faulty satellites based on satellite constellation-transmitted data. For translated systems the Ground Translator Processor (GTP) can further de-select translated measurements based on measurement quality observed by the reference receiver

portion of the GTP. A log of individual deselected satellites during dynamic simulation testing should be generated and used to ensure de-selection routines meet safety performance criteria. Range Safety should approve the satellite selection/de-selection routine.

l. **Acquisition Capability (R).** The typical minimum receiver sensitivity is -164 dBW.

m. **Quality/Confidence Indicators (Q).** These indicators flag conditions within the GPS hardware that indicate the hardware may not be performing within specification. Some indicators that should be considered include:

- (1) Validation that the GPS solution is being continually updated using the necessary number of satellites and is not in a “coast” mode.
- (2) Self-test of processor and memory system integrity
- (3) Tracking performance indicators such as DOP

A2.3.2.2 Other General Miscellaneous Candidate Requirements

- (1) **Stabilization Time (R).** The time needed after power application for the translator/receiver to satisfy all performance requirements should be minimized, measured, specified and then documented during development, qualification, and acceptance testing.
- (2) **Antenna RF Impedance Mismatch (R).** The translator/receiver should suffer no damage and meet all requirements after operating with the antenna connector open or shorted.
- (3) **Power Source Switching (R).** Internal or external power supply variations or repetitive switching between them should not degrade the operational performance of the translator/receiver.
- (4) **Phase Linearity (R).** Phase Linearity (phase vs. frequency) should be maximized to allow proper operation of the GPS.
- (5) **L₁/L₂ Bandpass Characteristics (R).** The minimum input RF passband should demonstrate margin over expected operational variations including Doppler shift, flight hardware manufacturing tolerances and antenna performance variations due to temperature. The RF passband should also minimize the effect of interference from other transmitting sources. L₁/L₂ bandpass characteristics should be specified in terms of amplitude ripple within the passband. Bandwidths should be specified at the 3dB/60dB points. These parameters should be used as status-of-health indicators.
- (6) **Phase Jitter (R) (A).** At a minimum, the phase jitter should be specified for the maximum predicted and qualification vibration environment.
- (7) **Noise Figure (R).** The noise figure should be specified and designed to ensure that the RTS is capable of providing tracking data throughout range safety responsibility. The typical noise figure range is expected to be 3-5 dB. The noise figure should be established in the receiver specification.
- (8) **RF Traps (R).** An airborne GPS system may need an RF trap to avoid desensitization from the RF downlink.

A2.3.3 Ground Translator Processor (GTP) Receiving/Processing Performance Requirements

a. **Maximum Dynamic Range (R) (A).** The GTP shall function within its performance specification when subjected to the minimum and maximum RF L-band input downlinked through the translator to the receiving ground station.

b. **Navigation Data Validity (R)(A)(D)(L)(S)(M)(Q).** The GTP single point failure verification shall be validated by analysis and test. The analysis shall examine individual electronic piece-part failures and software vulnerabilities to ensure there are no failure modes that would produce undetectable real-time out-of-specification navigation data. Testing shall exercise software and hardware capabilities by stressing the component to dynamic and environmental conditions described in Chapter 3.

c. **Immunity to Interfering Signals (R).** The GTP shall be designed to meet all safety performance requirements when subjected to the range RF transmitter environment.

d. **State Vector (A).** For nearly all vehicle applications on most ranges, standard C/A code tracking without differential GPS will meet safety performance tracking requirements. A higher degree of accuracy may be required in certain instances depending on numerous factors such as flight azimuth proximity to populated areas, sample rate, delay and vehicle dynamic capability (see paragraph A2.1.10). Most stringent vehicle trajectories can be met with a 100m and 0.3m/s 1σ present position accuracy. For missions requiring a more stringent accuracy, an increased accuracy must be provided or the mission may be limited (e.g. limiting trajectory) by safety constraints.

e. **Data Rate (S).** Typically, an update rate of at least 10 samples per second will meet most mission requirements. **Note:** For certain reentry bodies for ballistic missiles, 20 samples per second may be required.

f. **Delay Time (L).** For a 10 sample per second output, a 50 ms GTP delay time from signal acquisition to state vector output will meet most vehicle applications. A delay time of 125 ms from signal acquisition to the Range Safety Center processors will meet most vehicle applications.

g. **Measurement Set (M)(Q).** The GTP shall make the following data available: pseudo, delta pseudo range, DOPs, C/N₀, lock status, state vector, RAIM and satellite assignment.

h. **Rapid Re-Lock Capability (L)(R)(A).** The GTP re-lock time after a 5 second loss of RF satellite link shall provide a rapid relock capability of less than 1.5 seconds under worst-case dynamics.

i. **Time to First Fix (R)(A).** The GTP time to first fix shall be less than 5 second with no a prior data.

j. **De-Selection of Faulty Satellites (R)(A)(Q).** The GTP shall automatically identify and de-select faulty satellites. The GTP shall use the RAIM algorithm.

k. **Acquisition Capability (R).** The expected minimum receiver sensitivity is -164 dBW.

l. **Quality/Confidence Indicators (Q).** Flag indicators shall be made available that identify known failures and can create an out-of-specification state vector. At a minimum, the following indicators will be provided:

- (1) Validation that the GPS solution is being continually updated using the necessary number of satellites and is not in a “coast” mode.
- (2) Self-test of processor and memory system integrity
- (3) Tracking performance indicators such as DOP and RAIM

m. **Warm up time.** The GTP warm-up time shall be at least 15 minutes.

- (1) **The GPS Translator Processor (GTP) (R) (A).** The downlink receiving system may employ cross-polarized feeds. The GTP should have the capability to phase align and proportion the two polarization channel signals before combining to maximize the combined output SNR.
- (2) **Time Tagging.** The GTP should provide a time tagged state vector by utilizing a reference receiver capable of processing GPS signals received from the visible GPS satellites). The GTP shall provide a time tagged state vector with a 50ms resolution (sent 20 times per second) based to UTC (no measurable error).

A2.3.4 Differential GPS System (DGPSS) Performance Requirements (R) (A) (Q) (M)

a. The vehicle receiver shall downlink all data necessary to perform differential correction such as: pseudo range, pseudo range rate, measurement time, clock bias and drift, antenna ID, satellite ID, channel state, C/No (dB-Hz), DOPs, satellite ephemerides, and estimates of position, velocity and time.

b. **State Vector (A).** The DGPSS should incorporate a reference receiver to provide corrections to the pseudo range and pseudo range rate received from the vehicle receiver to meet this requirement. Additionally, the DGPSS may receive IMU data from the vehicle via the vehicle’s downlink system.

c. **State Vector Data Rate (S).** Typically, an update rate of at least 10 samples per second will meet most range safety requirements. **Note:** This does not apply to the differential correction refresh rate.

d. **Measurement Set (M).** Examples of data include, status of reference receiver and DGPSS and data links, DOPs, C/No (dB-Hz) of the reference receiver, and an indication of satellites deselected either by the reference receiver or operator input.

e. **De-Selection of Faulty Satellites (R) (A) (Q).** The DGPSS should have the capability to detect and de-select bad satellites from the solution for Range Safety display by 1) Operator control, 2) from message encoded in satellite signal, or 3) Reference Receiver (RR) measurement integrity check. For the case of a RR at a known location, the simplest fault detection method (1 and 2 are given) is to directly compare the pseudorange observed by the RR with the computed value and perform an edit test that assesses stability of a corrected pseudorange that can still be used to provide good position, velocity and time. If the difference passes the edit test, it becomes a differential correction for the corresponding vehicle measurement at that time interval; if not, the measurement from the satellite is flagged “bad” for this measurement interval and excluded from the solution. RAIM is generally inferior to direct observation/test because when measurement rates are high e.g. 10Hz, RAIM computations cannot be accomplished at the measurement rate.

A2.3.5 Airborne Inertial Measurement Unit (IMU) General Performance Requirements (R) (I) (M) (A) (S) (L) (Q)

a. **Alignment and Calibration (R) (A) (D) (L) (S) (M) (Q).** Verification of the alignment/calibration scheme should accordingly be keyed to requirement listed in paragraph 2.1.10.

- (1) **Gyro Scale factor errors (R) (A).** Gyro scale factor linearity, asymmetry, repeatability and stability errors shall be specified and support the capability to meet range safety performance requirements. Also, sensitivities of scale factors to temperature, supply voltage, vibration and any other factor shall be specified.
- (2) **Gyro Drift Rate (R) (A).** The gyro drift rate bias and random uncertainty after calibration shall be specified in a proper set of input angular displacement and time units, with respect to inertial space and support the capability to meet range safety performance requirements. Thermal effects and other environmental factors affecting gyro drift rate shall be included.
- (3) **Gyro input axis alignment errors (R) (A).** Maximum misalignment and the misalignment uncertainty of the gyro input axis with respect to the input reference axis shall be specified and support the capability to meet range safety performance requirements.
- (4) **Other gyro error sources (R) (A).** Error terms shall be specified and support the capability to meet range safety performance requirements if they are significant for the gyro design and the mission scenario. These parameters include drift rate sensitivity to acceleration squared, angular vibration sensitivity, coning, cross coupling and a dead band.
- (5) **Accelerometer scale factor (R) (A).** Accelerometer scale factor linearity, asymmetry, repeatability and stability errors shall be specified. Also, sensitivities of scale factors to temperature, supply voltage, vibration and any other relevant factor should be specified.
- (6) **Accelerometer bias (A).** The accelerometer bias uncertainty after calibration and the random component of accelerometer output not correlated with input acceleration shall be specified and support the capability to meet range safety performance requirements. Thermal cycles and other environmental factors affecting accelerometer bias shall be specified.
- (7) **Accelerometer axis misalignment (A).** Maximum misalignment and the misalignment uncertainty of the accelerometer input axis with respect to the input reference axis shall be specified and support the capability to meet range safety performance requirements.
- (8) **Other accelerometer error sources (A).** Error terms shall be specified and support the capability to meet range safety performance requirements if they are significant for the accelerometer design and the mission scenario: sensitivity to angular acceleration, cross coupling, dead band, geometric rectification, and vibration rectification.
- (9) **Operating Temperature (R).** The maximum and minimum ambient operating temperatures for the IMU shall be specified. The IMU/GPS should perform within specification at all design operating temperatures.

- (10) Initialization (M) (A).** The location and orientation of the inertial sensor relative to vehicle body coordinates, the WGS-84 geodetic coordinates of the inertial sensor, and the orientation of the IMU with respect to WGS-84 shall be provided.
- (11) Warm-up time (M)(A).** Instruments must produce specification performance after the required warm-up time. Flight vehicle systems shall have the required warm-up time on the RTS prior to lift-off.
- (12) Alignment Verification.** The range user must provide verification to ensure that the IMU is aligned within specification. The following options represent examples of how this requirement can be met.
- i.* IMUs that employ navigation-quality instruments are capable of identifying true North without external assistance. Navigation-quality gyros are typically characterized by drift rates corresponding to 1/1000 of earth rotation rate; the process of identifying true North without external aiding is called autogyro compassing.
 - ii.* Less expensive gyros can be assisted in the alignment process. Examples include optical references provided from surveyed positions and “handoff” alignments in which a sophisticated master unit hands alignment parameters to a less capable unit just before flight.
- b.* **Input Voltage (R) (A) (L).** Typically 22 to 45 VDC is considered the worst-case condition for power source variation.
- c.* **Gyro Input Rate Limits (S).** Instrument limits shall be listed in the component specification.
- d.* **Accelerometer Limits. (R) (A).** Instrument limits shall be listed in the component specification.
- e.* **Navigation Data Validity (R)(A)(D)(L)(S)(M)(Q).** This requirement should be validated by analysis and test. The analysis should examine individual electronic piece-part failures and software vulnerabilities to ensure there are no failure modes that would produce undetectable real-time out-of-specification navigation data. Testing should exercise software and hardware capabilities by stressing the component to dynamic and environmental conditions described in Chapter 3.
- f.* **State Vector.** A state vector with an accuracy of 100 m and 0.3 m/sec (.515 m/sec @ 95 percent for CE receiver) 2D rms at 10 sps using a state vector latency of less than 125 milliseconds will be adequate at most ranges for most high dynamic conditions.
- g.* **Data Rate (S).** Typically, an update rate of at least 10 samples per second will meet most mission requirements.
- h.* **Delay Time (L).** Typically, a 10 sample per second translator/receiver will process the new measurements and output a state vector in less than 125 ms. If required, destruct criteria may need to be made more conservative to account for a longer delay.
- i.* **Measurement Set (M) (Q).** Candidate examples of data in the RF downlink include the state vector and raw accelerometer data. If required, the IMU should provide gyro and accelerometer data in the following form. This gyro data is used to transform from vehicle body frame coordinates into a stabilized inertial frame of reference. This transformation from body to inertial is also applied to the accelerometer data, and then the accelerometer data is integrated into velocity in the stabilized frame. For applications that downlink the stable frame velocity and

the transformation derived from gyro data, this information should be stored in non-destructive readout accumulating registers with sufficient roll-over capacity to bridge expected telemetry dropout durations. The maximum computational errors induced in the transformation from body to stable inertial coordinates should be specified.

A2.3.6 RF Downlink Performance Requirements (R) (M) (Q) (S)

a. **Generation of Interfering Signals (R).** RF downlink spectral characteristics should comply with Range Commanders Council (RCC) document IRIG 106.

b. **Data Rate (S).** The RF downlink system should provide state vector data at a rate of 10 samples per second.

c. **Delay Time (L).** Typically, an TM downlink system that supports an airborne system delay of 125 ms, using a 10 sample per second state vector output, from the RTS solution to the time of ground instrumentation reception is acceptable for most range applications. If required, destruct criteria may be made more conservative to account for any increases in delay. The RTS derived time tag defining the time of state vector validity should be traceable to UTC.

d. **RF Downlink Characteristics (R).**

- (1). **Frequency Accuracy (R).** The expected value for this specification is 20 parts-per-million of design center frequency.
- (2). **Carrier Phase Noise (R).** The expected value for a 0.1 sec single Allan variance is better than one part in 10 to the 10th.
- (3). **Frequency Stability (R).** Frequency stability for the RF downlink carrier should be specified and support reliable de-commutation of the ground system.
- (4). **RF Downlink Bandwidth (R).** Recommended bandwidth measurements can be found in IRIG 106.
- (5). **Power Output (R).** The power output should be specified and used as a status of health indication during testing. Power output shall support the overall link budget to ensure data is continuously available to RSO throughout flight at the anticipated data rate. Power used for the link budget should use the 95 percent spherical coverage antenna pattern gain.
- (6). **Bit Error Rate (R).** An RF downlink bit error rate of 10^{-6} typically will meet all range safety data requirements for RTS receiver based systems.
- (7). **Suppression (R).** The RF downlink carrier suppression level should be specified, as applicable. Suppression should be used as a status-of-health indication.
- (8). **Fault Tolerance (R).** Two RF downlink systems should be utilized to ensure that a single failure in one RF system does not result in a total loss of vehicle tracking. Each RF downlink should utilize different power supplies. If possible, it is recommended that all airborne tracking and vehicle status health (including FTS critical functions) be available on both downlinks. Non-redundant passive components may be excepted.
- (9). **Link Closure (R).** The downlink system shall provide the ability to close the link and provide accurate and reliable data during nominal and non-nominal vehicle flight. Meeting the required link closure (e.g. power, bit rate and bit error) with a

95 percent spherical coverage is considered acceptable for non-nominal vehicle flight.

- e. **Measurement Set (M).** The required RTS component and system measurements are described in the applicable sections of this document.

A2.3.7 Airborne Coupled IMU/GPS Performance Requirements (R)(I)(M)(A)(S)(L)(Q)

- a. Raw GPS Data. (R) (I) (A) (Q). N/C
- b. Quality Indicator (R) (I) (A) (Q). N/C
- c. Stand-alone Observability (R) (I) (A) (Q). N/C
- d. Independence (I). N/C
- e. Other Candidate Requirements

- (1) **Time Tags (L).** Inertial measurements data that is down linked should be time tagged using IMU internal clock counts and the User's GPS receiver equipment time. The GPS derived time tag defining the state vector validity should be traceable to the UTC.
- (2) **Initialization (M) (A).** Location of the inertial sensor relative to the GPS antenna (S) in body coordinates should be provided.

A2.3.8 Airborne GPS Translator With Transmitter Performance Requirements (R) (I) (M) (A) (S) (L) (Q).

- a. **Maximum Dynamic Range (R)(A).** The translator shall function within its performance specification when subjected to the minimum and maximum RF L-band input.
- b. **Input Voltage (R)(A)(L).** Typically, 22 to 45 VDC is considered a worst-case condition for power source variation.
- c. **Immunity to Interfering Signals (R).** The translator immunity to expected interfering signals from the range and flight vehicle should be specified as a function of tracking and signal acquisition levels (3dB reduction). Susceptibility to combinations of up to three out-of-band continuous wave signals should be specified (e.g. C-band, S-band and UHF). Range transmitter source data can be acquired through the applicable Range Safety office.
- d. **Delay Time (L).** Delay time from L-band input to downlink output should be less than 1 ms.
- e. **Warm up time (A) (L).** The time needed after power application for the translator to satisfy all performance requirements should be specified and demonstrated during development, qualification, and acceptance testing.
- f. **Generation of Interfering Signals (R).** RF downlink spectral characteristics should comply with RCC Document IRIG 106.
- g. **RF Downlink Characteristics (R).**
 - (1) **Frequency Accuracy (R).** The expected value for this specification is 20 parts-per-million of design center frequency.
 - (2) **Carrier Phase Noise (R).** The expected value for a 0.1 sec single Allan variance is better than one part in 10 to the 10th.

- (3) **Power Output (R)**. The power output should be specified and used as a status of health indication during testing. Power output shall support the overall link budget to ensure data is continuously available to an RSO throughout flight at the anticipated data rate. Power used for the link budget should use the 95 percent spherical coverage antenna pattern gain.
- (4) **Bit Error Rate (R)**. A bit error rate of 5×10^{-2} typically will meet range safety requirements for translator-based systems.
- (5) **Link Closure (R)**. The downlink system shall provide the ability to close the link and provide accurate and reliable data during nominal and non-nominal vehicle flight. Meeting the required link closure (e.g. power, bit rate and bit error) with a 95 percent spherical coverage is considered acceptable for non-nominal vehicle flight. The following S/N margins shall be used to determine link margins:
 - a. **Analog Translator**: The GTP shall be capable of meeting all performance requirements with a 6 dB minimum S/N margin at the receiving antenna.
 - b. **Digital Translator**

DGT configuration	Standard	FEC Only	Encryption	Both
Eb/No (dB)	3.6	5.3	9.7	5.3

A2.4 RTS Ground Support and Monitoring Equipment Requirements

All RTS support equipment should be periodically calibrated in a laboratory whose standards are traceable to the National Institute of Standards and Testing. RTS support equipment includes, but is not limited to, the Safety Console, other consoles, antenna couplers (hats), RF sensitivity, satellite simulators, translator ground receiving/processing stations, and insertion loss test equipment.

A2.4.1 Operations Safety Console Data (R) (A) (M) (Q)

As applicable, the range user should provide the following RTS pre-flight and in-flight RF downlink monitors and controls continuously throughout the period of range safety responsibility:

- (1) Battery temperature
- (2) Battery current
- (3) Provisions for monitoring battery life, operating time, or other means of monitoring energy remaining for flight
- (4) RTS power transfer switch status (ON/OFF and AIRBORNE/GROUND)
- (5) GPS receiver health and tracking data
- (6) GPS translator health and tracking data
- (7) IMU or coupled IMU/GPS health and tracking data

A3.0 General Performance Verification Criteria

Test Plans/Procedures.

1. Performance verification test plans and procedures shall be submitted to Range Safety for review and approval. Test plans shall not be changed unless approved by Range Safety.
2. All test plans shall include instructions on how to handle procedural deviations.
3. The instructions shall describe test failure reaction requirements in detail.
4. All test schedules should be provided to Range Safety.
5. The test schedules should be updated as applicable.
6. Range Safety attendance may be desired depending on schedule and component criticality. Range Safety or a designated representative should be notified two weeks prior to the start of testing. Testing should not begin unless Range Safety has approved all applicable test procedures.

b. **Retest Requirements.** In the event of a Qualification, Acceptance, or Certification test failure that results in redesign or repair of a component, all previous Qualification, Acceptance, and/or Certification tests shall be repeated. The starting point and level of the re-testing shall be determined by a joint range/range user agreement and will be based on the extent of the redesign or rework of the component.

c. **Failure to Meet Component Specifications.** The failure of an RTS component to meet Range Safety approved specifications should be reported to Range Safety verbally within 72 hour and then in writing within 14 calendar days of the date the failure is noted. Components whose test data reflect the unit is out-of-family when compared to other units shall be considered as out of specification.

1. If a test discrepancy occurs, the test should be interrupted, the discrepancy verified, and Range Safety should be verbally notified within 24 hour. If the discrepancy is regarded as a failure of the test item, the preliminary failure analysis and appropriate corrective action plan shall be submitted to Range Safety before testing is resumed.
2. The failure analysis should include the cause of the failure, the mechanism of the failure, and isolation of the failure to the smallest replaceable item(s). The degree of retest should be determined for each case based upon the nature of the failure. The failure analysis plan should be developed and approved by a joint range/customer agreement before the test configuration is broken.
3. Flight hardware deficiencies should be examined in other identical/similar hardware to ensure there is not a generic design or workmanship concerns.
4. RTS components using COTS models (i.e. limited or no configuration control) must develop sufficiently stringent pass/fail constraints to ensure that manufacturing or design deficiencies are screenable.

d. **Testing Prior to Qualification.** Prior to the start of Qualification Testing, the component should satisfactorily pass the User Acceptance Test.

e. **Test Tolerances.** The test tolerances recommended in this document should be applied to the nominal test values specified. The maximum allowable tolerances shown in the table below reflect typical values expected for the recommended test margins and are consistent

with RCC 319 (FTS commonality standard). Any exceedance to the test tolerances below should be added to the qualification test levels to maintain the recommended design margin.

TABLE A3-0. TEST TOLERANCES	
Temperature	±3° C
Pressure	
Above 1.3×10^2 Pascals (1 Torr)	±10%
1.3×10^{-1} to 1.3×10^2 Pascals (0.001 Torr to 1 Torr)	±25%
Less than 1.3×10^{-1} Pascals (0.001 Torr)	±80%
Relative Humidity	±5%
Acceleration	±10%
Vibration Frequency	±2%
Sinusoidal Vibration Amplitude	±10%
Random Vibration Power Spectral Density (G^2/Hz)	
20 to 100 Hz (5 Hz or narrower bands)	±1.5 dB
100 to 500 Hz (25 Hz or narrower bands)	±1.5 dB
500 to 2000 Hz (50 Hz or narrower bands)	±3.0 dB
Sound Pressure Level	
1/3 Octave Band	±3.0 dB
Overall	±1.5 dB
Shock Response Spectrum (Q = 10)	
1/6 Octave Band Center Frequency Amplitude	+9 dB/-3dB
Static Load	±5%

f. Test Configuration.

1. Component Level.

- (a) All Qualification Testing shall use flight hardware (flight connectors, cables, cable clamping scheme, attaching hardware such as vibration and shock isolators, brackets and bolts) in a flight configuration.
- (b) In general, cables, which employ the worst-case unsupported flight length to the first tie-down point, are adequate to simulate the flight configuration.
- (c) Response accelerometers shall be placed in a location near the component under test to obtain an accurate representation of the actual component environmental level input. It is recommended that two accelerometers be used on diametrically opposing sides of the test item.

- (d) Complex test fixtures (e.g. used to test multiple components at once) should be characterized to ensure the required environments are being input into all test items.

2. System Level. All system level environmental testing of the RTS should be in the complete flight configuration.

A3.1 Certification Process (R) (A) (M) (S) (Q) (L)

The tests performed on the RTS fall into the following categories: User Development, Qualification, Range Certification, Range Pre-Flight, and Dynamic Simulations. See Figure A3-1 below. Based on specific range user vehicle and mission requirements, these candidate range safety performance requirements would be tailored to define the applicable requirements. Depending on the pedigree of the proposed RTS, the program might have to go through a complete or partial Design Verification/Qualification Test program and then proceed with Acceptance Testing of the Flight Units. The Design Verification/Qualification Units should go through User Development Tests and Qualification Tests. The Flight Units shall go through Acceptance Tests, Range Certification Tests, and Range Pre-Flight Tests. In addition, Dynamic Simulation Tests should be performed on the Design Verification/Qualification Units. A summary of this process is described in Figure A3-1 below.

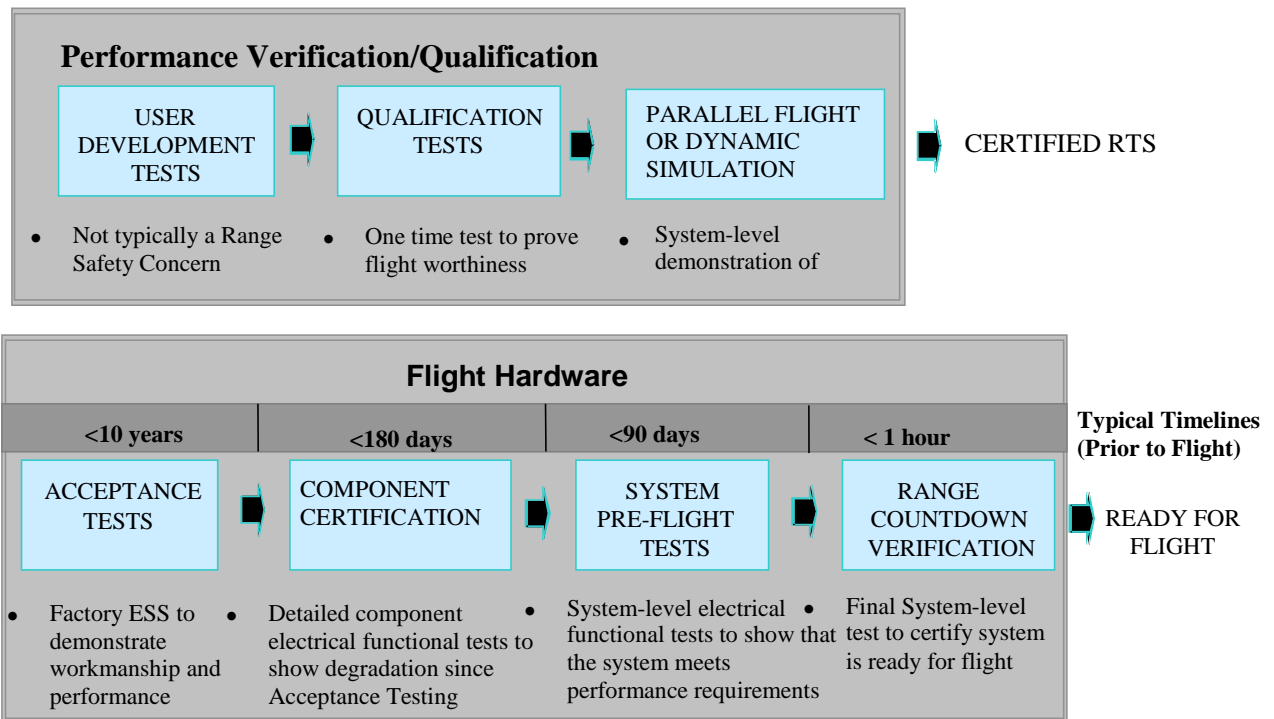

Figure A3-1 Component Certification Test Flow

A3.1.1 User Development Tests (R) (A) (M) (S) (Q) (L)

Range Safety participation in development testing is usually not required unless those tests are to be used to supplement qualification tests.

A3.1.2 Qualification Tests(R) (A) (M) (S) (Q) (L)

Qualification Tests are range user/vendor tests of flight representative hardware system or component designs to ensure suitability of the design to reliably operate and provide expected results during and after exposure to certain physical environments. Qualification test methodology also demonstrates that the complete system and individual components function within their specified performance parameters when exposed to environmental levels that exceed the maximum predicted flight levels during their service life. Qualification tests shall be performed on at least one test article although three test units is highly recommended. Test articles subjected to qualification testing are typically considered to be expended especially if the tests are destructive and should not be used for flight applications. However, depending on the extent of qualification testing, the units could possibly be refurbished and used as Flight Units.

- a. *Qualification by Similarity.* The early identification of potential candidate hardware, which is qualified by similarity, will allow the user to take proper action at the beginning of the program. Test data and written rationale, which supports the request for qualification by similarity in lieu of qualification by actual testing, should be provided. Each environmental requirement should be addressed and justified. Environments that are not justified may require a “delta” or limited qualification test to satisfy those environments. During the “delta” qualification test, some environmental tests may have to be repeated to ensure the cumulative effect of the environments do not degrade the component. Qualification by similarity means the similar RTS component, made by the same manufacturer, has been previously qualified by testing to environmental and functional performance requirements that meet or exceed the environmental and functional requirements of the new program. This does not mean qualification of similar RTS components, for example two different model GPS receivers, which may be made by the same manufacturer, simply because the manufacturer uses the same techniques and quality assurance procedures. It also does not mean qualification of RTS components made by different manufacturers, simply because the manufacturers were working from the same drawings and requirements. Qualification by similarity should be limited to items from a single source, having identical design and manufacturing processes. COTS products may not be capable of meeting these requirements and, therefore, shall be subjected to comprehensive testing to ensure each flight unit will meet all safety performance requirements (see paragraph A2.1 for COTS model options).
- b. *Previous Flight Experience.* Previous flight experience of the proposed RTS or any of its components will be a significant factor in determining the amount of qualification testing that would be required. It is imperative that the range user provides documentation regarding previous flight experience to the range for consideration. Previous flight experience may also reduce or eliminate any requirements for flight-testing the proposed RTS systems in parallel with traditional range tracking sources (i.e. radar). When comparing identical hardware on different launch vehicles, use on one vehicle does not automatically qualify a

unit for another vehicle purpose. Factors, which affect this comparison, include flight environments.

c. Re-Qualification and Delta-Qualification Tests. Re-Qualification/Delta-Qualification tests are often required for components whose manufacturer, manufacturing location, design, manufacturing processing, environmental levels, or requirements have changed. Re-Qualification may be required if significant time has elapsed since last production. The necessity for a re-qualification should be determined by a joint range/range user agreement and should concentrate on technical concerns associated with changes in parts, materials and processes.

A3.1.3 Acceptance Tests (R) (A) (M) (S) (Q) (L)

Acceptance Tests on the Flight Units are typically conducted at the range user/vendor facilities to demonstrate that each production end item meets the requirements of the specification and to reveal production inadequacies. Acceptance testing shall be performed on 100 percent of all RTS components and systems. This Acceptance Testing shall be identical to any User acceptance testing done on the Design Verification/Qualification Units. In addition, 100 percent vibration isolator testing is often necessary to ensure qualification margins are maintained if the resonant frequency and dynamic amplification are different between flight and qualification isolators. The acceptance test performance data will be used to evaluate "in-family" performance and item life cycle performance degradation.

A3.1.4 Component Functional Verification (R) (A) (M) (S) (Q) (L)

Component functional verification tests can be conducted on RTS components prior to installation in a higher assembly or may be tested on the vehicle as part of a system/subsystem level test. These verification tests shall use performance tests that represent a subset of the functional tests used during acceptance testing described in the applicable Appendix A matrices. Component verification tests are designed to detect changes in performance since the manufacturer's acceptance test procedure (ATP) or the last functional verification test was carried out. To maximize their effectiveness, such tests should be performed as close to launch day as possible. Verification test time limits will depend on the type of component and the overall vehicle configuration. Test data should correlate with the ATP baseline data and any previous test data. Differences in test results may indicate degradation in performance even if the functional parameters are still within specification. In this situation, the suspect RTS component should not be certified as flight worthy until all performance concerns are resolved. **Note:** The functional verification tests may be deleted if the time between acceptance testing and flight is within the timelines below or the component under test is capable of being tested at the subsystem/system level.

a. GPS receivers should be certified in accordance with the functional testing of Table A3-3a. This is typically performed within 180 days of launch (or other time as agreed to by the range and range user). As described in the test portion of Table A3-3a, dynamic simulation, TEST 2, should be used for bench testing GPS receivers.

b. GPS translators should be certified in accordance with the functional testing of Table A3-3b. This is typically performed within 180 days of launch (or other time as agreed to

by the range and range user). **Note:** It may not be necessary to test the translator with an actual flight configured Ground Translator Processor (GTP). As long as the GTP remains under configuration control, it is possible to only test flight translator hardware critical performance parameters and status-of-health measurements. If the GTP is not under configuration control, then it may be necessary to test the entire system end-to-end using a flight configuration. If possible, it is highly recommended that the dynamic simulation, TEST 2, referenced in A3-3b, be performed at the system level (using the vehicle antennas, GTP, transmitter and GTP), in lieu, of performing the test at the component level. **Note:** For GPS systems that incorporate the RF downlink and translator, as a single unit, the RF downlink transmitter matrix, Table A3-3c, is also applicable.

c. RTS batteries should be certified to the maximum extent possible, depending on the type of battery, within 30 days prior to launch. Remotely activated silver-zinc and thermal battery squibs resistance values should be verified to be within specification during the missile assembly and checkout process. Nickel-Cadmium batteries should run through charge/discharge tests as late as possible prior to launch. The range user with Range Safety personnel participation should conduct the certification test.

d. Reuse Tests are conducted to re-certify an RTS component for another flight. Approval for reuse of an RTS component is typically obtained from the Range Safety Office of the affected range. Test requirements are often based on the component design and on the flight and recovery environments experienced on previous flights. Design margins, environments, and reuse/refurbishment plans should be addressed early in the design cycle when reuse is desired. Reuse Testing is expected to be accomplished by the same facility that performed the Acceptance or Certification Tests and is under the same time constraints. The test data shall correlate with the ATP baseline data and any previous certification test data.

A3.1.5 Pre-Flight Tests (R) (A) (M) (S) (Q) (L)

Range pre-flight tests involve sub-system level and system level tests. The range user should provide procedures to verify the proper performance of the RTS during these tests. In addition, Dynamic Simulation could be used during these tests to further verify proper processing of critical range safety parameters.

A3.1.5.1 Subsystem Tests (R) (A) (M) (S) (Q) (L)

Subsystem Tests involve checkout of partially assembled system, which cannot be adequately tested during system level checkout. These tests may include testing to ensure that there are no out-of-family conditions.

a. The L-band and RF downlink system should undergo a VSWR/Insertion Loss test prior to final assembly.

b. Translator Ground Receiving/Processing Station shall be tested as a subsystem using a combination of Built-In Test (BIT), known origin dynamic simulations, and observation of actual GPS satellites. The following subsystem tests involve checkout of the GTP:

- (1) Co-location test: Compare tracking solutions from different inputs for consistency. In addition, the antenna location shall be surveyed and used as a comparison to indicate the health of all inputs.

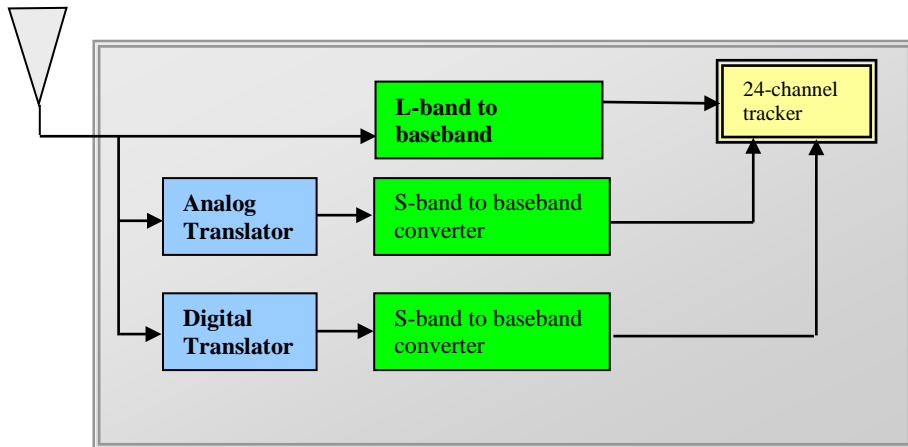

Figure A3-2. Co-location Test Setup

- (2) Diagnostic Test:
Run self-test to validate the full range of GTP functions needed for mission support. This test must ensure that any component within the GTP, which is out of specification, or calibration is detectable.

A3.1.5.2 System Test (R) (A) (M) (S) (Q) (L)

An end-to-end system test should be performed to ensure that the entire RTS system including the vehicle's downlink signal is correctly processed and displayed by the range. The end-to-end test includes all RTS vehicle hardware in its final flight configuration as well as all ground support systems to the display of the RSO.

a. GPS

- (1) A test should be performed within 90 days of the mission that includes injecting a simulated downlink signal at one or more range support stations and monitoring range displays for presentation. The simulation may replicate nominal and anomalous vehicle trajectories.
- (2) A test shall be performed prior to launch. This shall include reception of GPS satellite signals by the vehicle, transmission of downlink signals from the vehicle, reception of the downlink signals by one or more range support sites, and monitoring range displays for presentation. A final verification of an RTS performance should be performed on vehicle power.
- (3) In some cases, a dynamic simulation test may be necessary should be performed for the anticipated constellation during the intended vehicle operational flight time. This test should use a flight configured vehicle and a dynamic simulator providing an input into the flight L-band antenna system through an antenna hat. This test would also determine if there were sufficient satellites in the proper

geometry to support range safety reliability and accuracy requirements.

Depending on the application, it may be necessary to limit take-off/launch and flight times to ensure the proper constellation is available throughout range safety responsibility.

- (4) A complete RF compatibility test should be demonstrated on a fully configured flight vehicle while all airborne and ground transmitting sources are radiating. During this test, the GPS receiver should be tracking real-world satellites in a flight-hardware configuration (including antennas, receivers and supporting hardware).

b. IMU

- (1) Pre-launch Checks for Inertial Components. There are many ways to perform system level checks; for example, a ground-located IMU in the pre-launch mode can only observe earth rate (gyros) and acceleration (accelerometers) due to local gravity (typically about 1 g). Under these circumstances, a combination of pre-flight IMU output observation and mission simulation is a typical method of confirming readiness for flight. Several pre-flight observations are available. First, the IMU state vector can be compared to the best estimate of position from other sources. These sources can include the geodetic survey point for ground-launched vehicles or position fixes from aircraft navigation systems for aircraft-launched vehicles. Additionally, instrument-level data from the alignment and calibration process can provide insight into the state-of-health of the IMU. Mission simulation employs the flight computer to “fly” the mission in a simulated mode before actual flight. Guidance and control systems that are mechanized for such simulations use the flight computer to issue steering commands that replicate the impending mission. These commands verify the ability of the guidance set to issue proper commands to control devices such as control surfaces or rocket nozzles and to ensure that the devices respond properly to the stimulation. Mission simulation does not include the ability to check or observe performance of inertial components under actual flight conditions.
- (2) For systems that combine inertial and GPS tracking, pre-launch confirmation checks should include inertial checks listed above and Test 4 (and associated analysis) described in paragraph A3.1.7. The blended solution should be monitored during IMU tests discussed above and GPS tests listed in A3.1.8. Compare the GPS-only solution to the blended solution throughout this process.
- (3) After takeoff, another independent tracking source shall be used to validate the performance of an IMU-based tracking system. The additional tracking source shall have the accuracy and performance necessary to ensure the validity of the IMU-based tracking system. This validation should be reevaluated after each vehicle event such as staging.

c. Ground Translator Processor

- (1) A test shall be performed within 90 days of the mission that injects a dynamic simulated input signal via PTSRF recording (data log playback, mission or

- dynamically simulated signal) or dynamic simulator into the GTP range support stations. The resulting state vector shall be displayed at the RSO consoles. The simulation should replicate a representative nominal vehicle trajectory.
- (2) Boresight Tower Test: 90 days prior to the mission, mount a translator on a surveyed tower and point a TM/GTP antenna at the boresight tower and verify that the GTP state vector is within specification.
 - (3) An end-to-end static system test shall be performed to ensure that the entire GTP ground system including the vehicle's downlink signal is correctly processed and displayed by the range. The end-to-end test includes all RTS vehicle hardware in its final flight configuration as well as all ground support systems to the display of the RSO.
 - (4) Aircraft End-to-End Test (One-time QTP test): Fly an analog/digital translator on an aircraft which transmits the translated signal to TM/GTP ground system and display state-vector on Range Safety Center screens. Compare GTP translated state vector with true values obtained from other sources (i.e. radars).

A3.1.6 Functional Tests (R) (A) (M) (Q) (L)

Functional Tests are detailed electrical/RF performance tests run to demonstrate design specifications. Detailed specification limits are used for these tests to determine out-of-family measurements or degradation in performance, which could indicate that a flight article may contain deficiencies not screened during acceptance testing. These deficiencies may not result in a system failure (i.e. inability to obtain tracking data) during ground processing but could lead to in-flight failures when subjected to flight environments. Functional tests are typically performed during Acceptance, Qualification and Range Certification tests.

A3.1.7 Dynamic Simulations Test (R) (A) (M) (Q)

Dynamic simulation tests are used to provide simulated GPS satellite signals into a GPS unit under test. The satellite signals emulate vehicle motion. This emulation simulates high dynamic events, as well as, nominal trajectories. The extent of dynamic testing will depend on the specific range safety requirements and should be tailored for each unique application. Dynamic simulation should meet the following requirements:

1. The dynamic simulator and the simulator operator shall demonstrate the capability to accurately replicate the test and flight trajectories.
2. All critical performance criteria such as state vector, C/N_0 , satellites tracked and pseudoranges shall be monitored and recorded.
3. The following test methodology utilizes a recommended approach. Table A3-2 below recommends tests for each phase of vehicle processing.

TABLE A3-2. RECOMMENDED DYNAMIC SIMULATION/ANALYSIS TEST APPROACH					
	Qualification	Acceptance	Certification	System Pre Flight	Flight Countdown
Test Verification (See paragraph 1)	TEST 1 TEST 2 TEST 3	TEST 2 TEST 3	TEST 2	TEST 4	TEST 4 ANALYSIS 1

TEST 1: This dynamic simulation test uses a GPS constellation simulator to make GPS components respond as if they were actually in motion. This test shall input the representative flight trajectory and utilize flight-configured parameters such as roll-rates, antenna patterns, moment arms and launch times/dates (i.e. constellation geometry at liftoff) to demonstrate the capability of the GPS to function within specification during flight.

TEST 2: This dynamic simulation test will utilize a standard series of dynamic environment (velocity, acceleration, and jerk) and signal levels as input. This test can be the same for all GPS hardware and should utilize a standard series of dynamic environment and signal level inputs. This test would incrementally increase key parameters to determine threshold limits. Threshold limits are determined by loss of lock or out-of-specification performance. The test configuration would use four satellites at 45 degrees elevation and separated equally by 90 deg azimuths. A satellite directly overhead is used as the satellite to direct the dynamics toward/from in accordance with the Figures A3-3, A3-4 and A3-5. These tests are used to characterize the tracking performance in the following stressing environments:

1. **Acceleration Test.** Figure A3-3 demonstrates a recommended test methodology. If started from zero velocity it integrates to about 6000 meters/sec at 60 seconds (assuming the peak point is at 20 g).

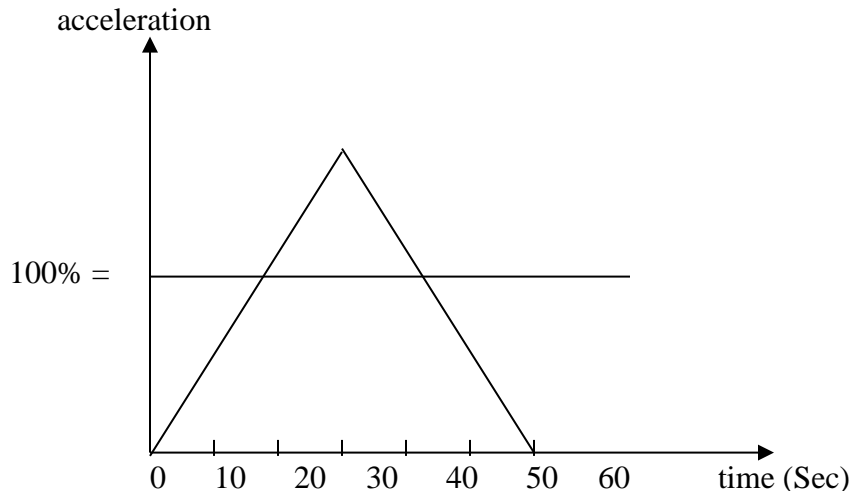

Figure A3-3. Acceleration Test Profile for Dynamic Simulation Testing
(Intended to test loss of tracking on the upward ramp and reacquisition on the downward ramp.)

2. **C/No Test.** Figure A3-4 shows a simple C/No response test.

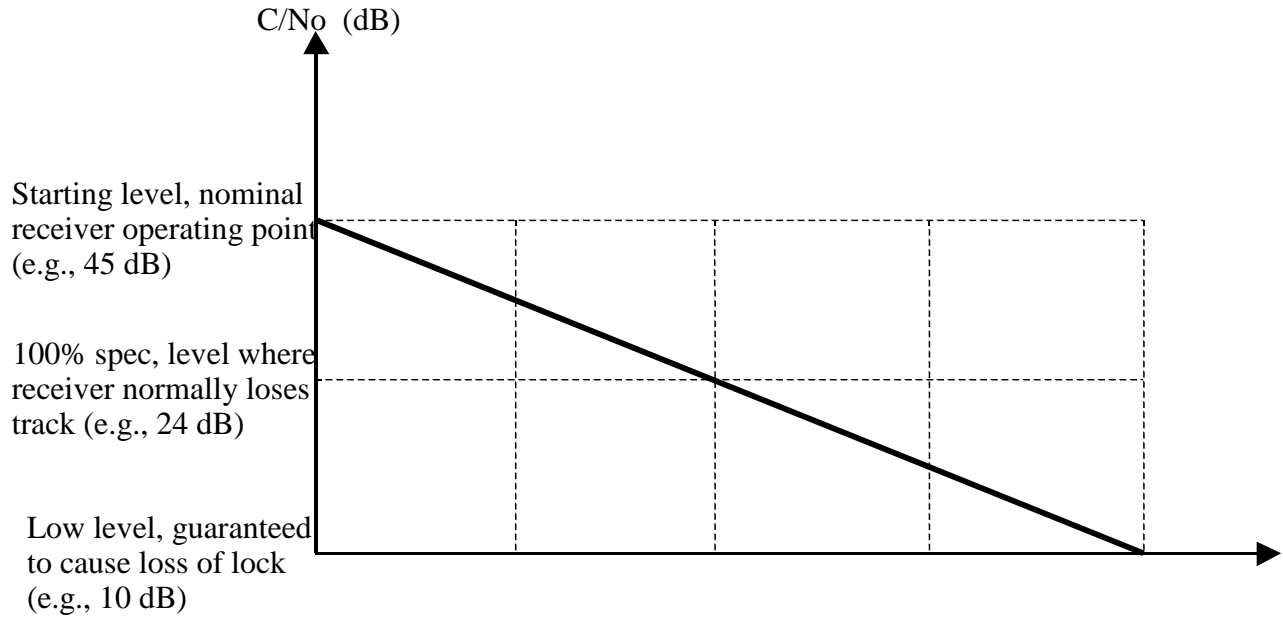

Figure A3-4. C/No Profile for Dynamic Simulation Testing
(C/No test with thermal noise stress and acceleration kept at maximum level (11 g)).

3. **Jerk Test.** Figure A3-5 presents a test profile for the jerk tests. The profile shown keeps the acceleration within its maximum level of 11 g. It is assumed that positive and negative jerk are equally stressing to the receiver. Periods of zero jerk in between non-zero values should stabilize the receiver for the next event. The acceleration should be kept constant at the previous level until the new jerk ramp start changing it.

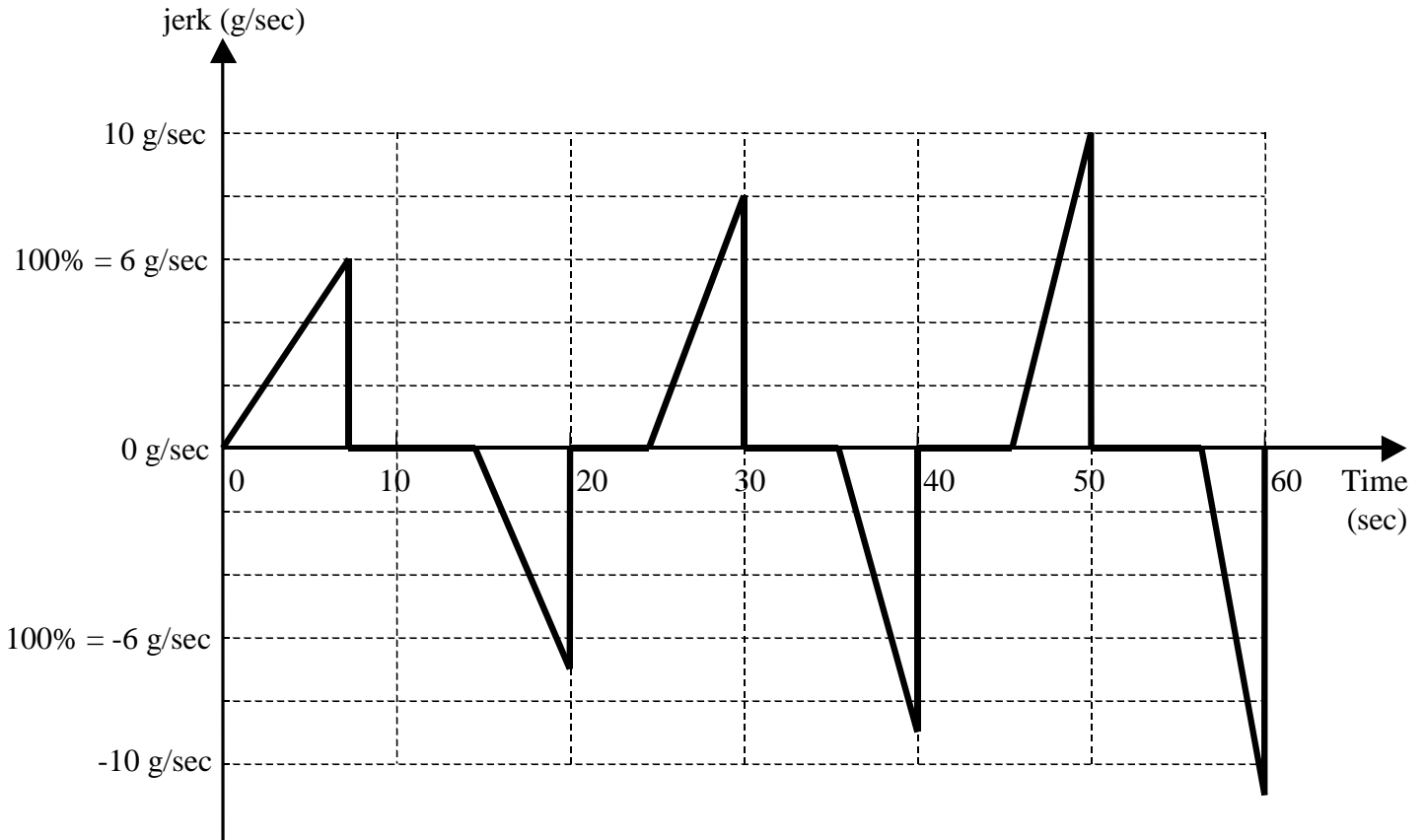

Figure A3-5. Jerk Profile for Dynamic Simulation Testing
(Suggested jerk profile to test jerk limits without exceeding the 11 g example acceleration limit)

TEST 3: This test applies a static point in space and is used for tests that are short in duration (e.g. acceptance vibration). The intent of this test is to determine state vector variation during environmental exposure and serves as a status-of-health of the GPS component. This test should be done with a dynamic simulator to minimize errors introduced by the reference L-band signal.

TEST 4: This test utilizes the actual GPS constellation to verify the GPS system capability to resolve its static location. Presentation of the navigation solution on Range Safety displays will verify range compatibility. An evaluation criterion for this test includes: DOP, C/N₀ and accuracy of the GPS calculated position when compared to a surveyed location position.

ANALYSIS 1: This analysis utilizes the planned vehicle trajectory, antenna patterns, moment arms, roll rate, and planned launch date/time (including hold capability) and computes GPS performance throughout the expected flight profile and is intended to supplement the data acquired in TEST 1. The intent of this analysis is to determine if the satellite constellation from lift-off to the end of range safety responsibility will meet minimum tracking performance requirements. To account for launch schedule delays, a series of these analytical simulations should be run to take into account different launch times; these simulations should consider any new potential launch time or day. A DOP analysis, using the planned vehicle trajectory and expected launch times, including hold capability, should be computed in one-second increments for critical phases of the flight profile. Other phases of flight can use longer increments to minimize the computing time. This analysis should identify periods, in which, the minimum tracking requirements are not met. **Note:** It is recognized that the GPS may experience loss of data in certain situations such as: liftoff, staging and plume attenuation. In addition, decreased accuracy may be acceptable during periods of the mission that pose less risk to public safety. This analysis should be run in the pre-planning phases of vehicle development.

A3.1.8 Parallel Flight Tests (R) (A) (M) (S) (Q) (L)

A minimum of three flights is needed to provide the experience necessary to gain confidence in a proposed tracking system. Parallel flight tests consist of using a flight configured RTS and TM downlink system on a launch system along with another Range Safety certified tracking source. Tracking data collected from this test shall be compared against the expected performance that may include expected dropouts, DOP degradation, accuracy and data latency. If the expected and actual values do not correlate within the performance requirements levied in this document, additional flight tests may be required to characterize the variability. Once the performance of the RTS source is understood, it can be tailored to the requirements and conditions of this document. It may be possible to utilize dynamic simulation to supplement or replace parallel flight-testing if it can be shown that the dynamic simulation is an accurate representation of the flight environment through flight data comparisons. These flight data comparisons can be obtained from parallel flight tests performed on other vehicles off any range. The use of dynamic simulation in place of parallel flight-testing shall be approved on a case-by-case basis. Due to range unique hardware, at least one of the certification flights shall occur at the range to be flown on.

A3.1.9 Reuse Testing (R) (A) (M) (S) (Q) (L)

Qualification testing should be performed to demonstrate a margin over the worst-case pre-flight, flight and acceptance test environments. Acceptance and certification testing should be performed periodically to ensure that previous non-operating and operating environmental exposure have not degraded flight hardware. The matrices in Appendix A should be specifically tailored to describe the detailed test requirements.

A3.1.10 Special Tests (R) (A) (M) (S) (Q) (L)

Special tests are those tests necessary to prove a unique performance specification. The need for special tests should be determined by a joint range/range user agreement. It is recommended that the tables within this document be used as a baseline to develop requirements for unique applications.

A3.1.11 Reference Functional Tests

Reference functional tests represent a limited sampling of critical parameters that are performed during environmental testing. These tests ensure that all minimum functions critical to unit functionality are exercised along with sufficient status-of-health indications to identify potential performance degradation.

A3.2 Component Performance Verification Requirements (R) (A) (M) (S) (Q) (L)

A3.2.1 Overview of This Section

This section contains common test requirements for all RTS components to allow an RTS component to be used on a wide variety of applications and ranges. Components exposed to the applicable tests (as tailored in the test matrices) of this section shall meet all applicable range safety performance requirements. **Note:** For specific applications, many of these tests may not be applicable.

a. Recommended detailed testing procedures can be referenced in MIL-STD-810, RCC 319, MIL-HNDBK-1540 or other similar documents. Many of the requirements in this section are derived from these documents.

b. Pre- and post-environmental test data shall be compared for any significant changes to provide confidence that critical performance parameters are maintained throughout applicable operating and non-operating environments.

c. Tests referenced in the following matrices represent individual tests requirements. In some cases, it may be desirable to combine multiple tests into a single test (e.g. temp/altitude/humidity or vibe/temp) depending on the flight application.

A3.2.1.1 Visual

Visual examination ensures good workmanship has been employed and that the component is free of obvious physical defects. Visual examination may include optical magnification, mirrors or specific lighting (e.g. UV illumination).

A3.2.1.2 Dimension

The physical dimensionality of the test unit should be checked to ensure that it is within the dimensional limits that are specified in the applicable component specification.

A3.2.1.3 Identification

Component identification tags should be checked to ensure that they contain the necessary information for configuration control and traceability.

A3.2.1.4 Disassembly

Disassembly inspects for excessive wear and damage after exposure to qualification level environments. **Note:** A component that exhibits any sign that an internal part is stressed beyond its design limit (cracked circuit boards, loose connectors/screws, bent clamps/screws, worn parts) shall be considered a failure of the component under test even if the component passes the final functional test. The level of inspection is typically determined during the qualification test procedure review process; however, the following criteria shall be considered:

- a. Components that require disassembly shall be completely taken apart to the point at which all internal parts are inspectable.
- b. A component that exhibits any sign that a part is stressed beyond its design limit (cracked circuit boards, loose connectors and/or screws, bent clamps and/or screws, worn parts) shall be considered a failure even if the component passes the final functional test.
- c. All internal components and subassemblies such as circuit board traces, internal connectors, screws, clamps, electronic piece parts, and mechanical subassemblies shall be examined using an appropriate inspection method (magnifying lens, radiographic).
- d. Components such as antennas, potted units, and welded structures that cannot be disassembled due to manufacturing techniques may be required to meet special inspection criteria. This may include depotting units, cutting components into cross-sections or radiographic inspection.

A3.2.1.5 Leakage

Leakage testing ensures that the sealing is within the specification limit for both before and after environment. The leakage test selected by the range user shall have adequate accuracy and resolution to verify the required component leakage rate specification. **Note:** Components sealed to a rate equivalent to 10^{-4} scc/sec of Helium are considered environmentally sealed and protected against internal non-operating environmental damage.

A3.2.2 RESERVED

A3.2.3 RESERVED

A3.2.4 Non-Operating Environments

Components tested to the applicable requirements of this section (as tailored in the test matrices), must meet all range safety performance requirements after being subjected to the required test. **Note:** The unit is not required to function during these tests.

A3.2.4.1 Storage Temperature

Storage temperature testing validates the component's ability to withstand high and low temperature thermal cycle and dwell storage conditions without degradation in performance.

- a. Thermal testing shall ensure a minimum 10°C margin above the maximum predicted storage thermal environment at low and high temperature.
- b. Thermal dwell time and the number of thermal cycles shall be 3 times the MPE.
- c. Storage temperature testing is often demonstrated by analysis if operational thermal cycle is a more conservative test. This can be done by utilizing thermal fatigue equivalence that converts a high ΔT with few thermal cycles to a lower ΔT for many thermal cycles.

A3.2.4.2 Transportation Shock Test

Transportation shock testing is performed to demonstrate component survivability during worst-case transportation induced shock levels in their transported configuration. Transportation shock testing is often performed by analysis if operational shock testing is a more conservative test.

A3.2.4.3 Bench Handling Shock

Bench handling shock testing is performed to demonstrate component survivability during worse case bench handling induced shock levels.

A3.2.4.4 Transportation Vibration

Transportation vibration testing is performed to demonstrate component survivability during worse case transportation induced vibration levels in their transported configuration. Transportation vibration testing is often performed by analysis if operational vibration testing is a more conservative test. In addition, the use of fatigue equivalence to convert high-level vibration for short duration to low level vibration for high duration is an acceptable methodology to meet transportation vibration. The minimum transportation vibration test level should utilize a 3-axis component test to the following levels for 60 minutes per axis:

- 0.01500 g^2/Hz at 10 Hz to 40 Hz
- 0.01500 g^2/Hz at 40 Hz to 0.00015 g^2/Hz at 500 Hz

- **Note:** If the test component is resonant below 10 Hz, extend the curve to the lowest resonant frequency.

A3.2.4.5 Fungus Resistance

This test is intended to demonstrate the capability of the component to withstand a fungus environment. This requirement is often met by analysis if it can be shown that all unsealed and exposed surfaces do not contain fungus nutrient materials.

A3.2.4.6 Salt Fog

Salt fog testing is performed to demonstrate component survivability to the effects of a moist, salt-laden atmosphere. This test is applicable to any component that will be exposed to salt fog conditions while in service. Components environmentally sealed (10^{-4} scc/sec of He) and 100 percent acceptance tested to verify the integrity of the seal do not require salt-fog testing for internally sealed parts. However, externally exposed surfaces shall demonstrate by test or analysis that the salt-fog environment does not affect them.

A3.2.4.7 Fine Sand

This test demonstrates the ability of components to withstand the effects of dust or fine sand particles to penetrate into cracks, crevices, bearings and joints. This requirement is primarily intended for moving mechanical assemblies and optical systems. Components environmentally sealed (10^{-4} scc/sec of He) and 100 percent acceptance tested to verify the integrity of the seal do not require fine sand testing for internally sealed parts. However, externally exposed surfaces shall demonstrate by test or analysis that the fine sand environment does not affect them.

A3.2.5 Qualification Operating Environments

Qualification tests are range user/vendor functional tests of flight representative hardware system or component designs to ensure suitability of the design to reliably operate and provide expected results during and after exposure to certain physical environments. Qualification tests are performed at the anticipated flight level plus a margin. Depending on the application, qualification environments may be required to be combined to address performance during flight environments, which occur simultaneously (e.g. vibration/thermal). Components tested to the applicable requirements of this section (as tailored in the test matrices) must meet all range safety performance requirements during and after all required testing.

A3.2.5.1 Sinusoidal Vibration

Sinusoidal testing is performed to ensure the survivability of RTS components in a flight sinusoidal vibration environment. The following criteria shall be used to demonstrate this requirement.

- a. Sinusoidal vibration test level shall be 6 dB greater than MPE.

b. Test duration/persistence of the sinusoidal sweep rate shall be a minimum of 3 times the MPE sweep rate on all 3 axes.

c. The test tolerance used shall be ± 10 percent. If larger test tolerances are use, an appropriate factor shall be added to the qualification level to maintain the required margin between MPE and qualification.

d. The sinusoidal frequency range shall be the MPE worst-case frequency range plus and minus a 50 percent margin.

e. An analysis may be used that shows operational random vibration testing envelopes qualification sinusoidal vibration; for this analysis, random vibration statistics for peak G-levels versus time shall envelope the sinusoidal qualification levels and durations.

A3.2.5.2 Random Vibration

Random vibration testing is performed to ensure survivability of RTS components in a random vibration workmanship or flight environment. RTS components (e.g. isolators, grounding straps, brackets, ETS and flight cables to first tie-down) shall not degrade in performance when subjected to qualification random vibration levels and durations. Response accelerometers shall be placed as close to the component as possible. All RTS components, whether hard-mount or isolator mounted shall meet the following requirements.

a. Random vibration test level shall be 6 dB greater than MPE from 20 Hz to 2000 Hz in each of the 3 orthogonal axes.

b. A minimum qualification test level (see Table A3.2.5.2) shall be maintained to ensure a 6 dB margin between flight hardware acceptance minimum workmanship testing and the qualification test units.

c. For short duration environments, the test duration shall be at 3 times the MPE or a minimum of 180 seconds in all 3 mutually perpendicular axes (i.e. three times the acceptance test duration). For extended duration environments (e.g. captive carry), the test duration can be reduced to a margin of 30 percent over the maximum expected environmental exposure or the acceptance test environmental stress screen duration, whichever is greater.

d. Regardless of qualification test methodology, acceptance testing shall be performed using identical test methods except the qualification margins and durations are removed.

e. Where there is insufficient time at the full test level to test all functions and modes, extended testing at a level 6 dB lower shall be conducted as necessary to complete functional testing.

f. The test tolerance used should be ± 1.5 dB. If larger test tolerances are used, an appropriate factor shall be added to the qualification level to maintain the required margin between MPE and qualification.

TABLE A3.2.5.2. MINIMUM POWER SPECTRAL DENSITY FOR QUALIFICATION RANDOM VIBRATION	
Frequency Range (Hz)	Minimum Power Spectral Density
20	0.021 g ² /Hz
20-150	3 dB/Octave Slope
150-600	0.16 g ² /Hz
600-2000	-6 dB/Octave Slope
2000	0.014 g ² /Hz
Overall G _{rms} = 12.2	

A3.2.5.3 Acoustic

Acoustic testing is performed to ensure the survivability of RTS components in a flight environment. The following criteria shall be used to demonstrate this requirement.

- a. MPE flight acoustic levels plus a 6 dB margin from 20 Hz to 2000 Hz.
- b. The test duration shall be at 3 times the MPE or a minimum of 180 seconds in all 3 mutually perpendicular axes (i.e. three times the acceptance test duration).
- c. Where there is insufficient time at the full test level to test all functions and modes, extended testing at a level 6 dB lower shall be conducted as necessary to complete functional testing.
- d. Components may be qualified by analysis if it can be shown that operating random vibration envelopes qualification acoustic levels and durations.
- e. The test tolerance used should be ± 1.5 dB. If larger test tolerances are use, an appropriate factor shall be added to the qualification level to maintain the required margin between MPE and qualification.

A3.2.5.4 Shock

Shock testing is performed to ensure the survivability of RTS components in a flight environment. The following criteria shall be used to demonstrate this requirement.

- a. MPE flight shock levels plus a 6 dB margin from 100 Hz to 10000 Hz. The applied shock transient shall provide a simultaneous application of all frequency as opposed to a serial application.
- b. 3 shocks in each direction along each of the 3 orthogonal axes.
- c. The shock duration shall simulate the actual event.
- d. The test tolerance used should be $+9/-3$ dB. If larger test tolerances are use, an appropriate factor shall be added to the qualification level to maintain the required margin between MPE and qualification.

A3.2.5.5 Acceleration

Acceleration testing is performed to ensure the survivability of RTS components in a flight or breakup acceleration environment. The following criteria shall be used to demonstrate this requirement.

- a. The acceleration test level shall be at least two times the MPE.
- b. The duration of the acceleration shall be three times the MPE in each direction for each of the three orthogonal axes.
- c. The test tolerance used should be ± 10 percent. If larger test tolerances are use, an appropriate factor shall be added to the qualification level to maintain the required margin between MPE and qualification.
- d. An analysis may be used that shows operational random vibration testing envelopes qualification acceleration environments; for this analysis, random vibration statistics for peak G-levels versus time shall envelope qualification acceleration levels and durations.

A3.2.5.6 Humidity

RTS components shall function within specification after being subjected to worst-case storage, transportation and preflight environments. Humidity testing is performed to demonstrate the performance of RTS components when subjected to worst-case humidity environments. Humidity testing typically involves exercising key performance and status-of-health parameters during thermal-cycle/humidity qualification environments. Functional tests shall be performed at worst-case high and low voltages.

A3.2.5.7 Thermal Cycle

Thermal cycle testing is performed to ensure survivability of RTS components for a workmanship, pre-launch or flight environment using the following criteria:

Electronic Components.

- a. The component thermal cycle range shall be at the MPE high temperature plus 10°C or 71°C, whichever is higher, and at the MPE low temperature minus 10°C or -34°C, whichever is lower.
- b. The number of thermal cycles shall be a minimum of 24 cycles. Each cycle shall have a 1-h minimum dwell at the high and low temperature levels during which the unit should be turned off until the temperature stabilizes and then turned on.
- c. The dwell time at the high and low levels shall be long enough to obtain internal thermal equilibrium.
- d. The test unit transitions between low and high temperatures should be at an average rate of at least 1°C per min or maximum expected rate, whichever is greater.
- e. As applicable, the test unit shall be functional tested at the first, middle and last, hot and cold thermal dwell cycle at worse case low and high operating voltage. Critical parameters shall be monitor at the nominal operating voltage for other cycles and during thermal transition.

RF Components.

- a. The component thermal cycle range shall be at the MPE high temperature plus 10°C or 71°C, whichever is higher, and at the MPE low temperature minus 10°C or -34°C, whichever is lower.
- b. The number of thermal cycles shall be a minimum of 24 cycles. Each cycle should have a 1-hr minimum dwell at the high and low temperature levels. The dwell time at the high and low levels shall be long enough to obtain internal thermal equilibrium.
- c. The test unit transitions between low and high temperatures should be at an average rate of at least 1°C per min or maximum expected rate, whichever is greater.
- d. As applicable, the test unit shall be functional tested at the first, middle and last, hot and cold thermal dwell cycle. Critical parameters shall be monitor for other cycles and during thermal transition.

A3.2.5.8 Thermal Vacuum (Temperature Altitude)

Thermal vacuum testing is performed to ensure the survivability of RTS components in a temperature/altitude environment. The component under test shall not degrade in performance or structural integrity when subjected to combination altitude and thermal environments using the following criteria:

- a. The component temperature shall be at the maximum flight predicted high temperature plus 10°C or 71°C, whichever is higher and at the minimum flight predicted low temperature minus 10°C or -34°C, whichever is lower.
- b. The pressure gradient shall reflect the expected rate of altitude change, which will be experienced during flight. The final vacuum dwell shall be sufficiently long to ensure the component under test has the opportunity to achieve pressure equilibrium.
- c. The number of thermal cycles shall be three times the expected thermal altitude cycles. These thermal cycles shall be performed during final vacuum dwell.
- d. The component under test shall be operated at maximum power and critical parameters monitored during chamber pressure reduction and final vacuum dwell. Functional tests shall be performed at worst-case high and low voltages.
- e. To utilize an analysis in lieu of a test will require demonstration that the component is not susceptible to corona, arcing or structural failure. High voltage (i.e. greater than 50V) components, which are environmentally sealed, will only require an analysis of low voltage exposed external parts. **Note:** Any high voltage externally exposed part will require qualification thermal vacuum testing. Low voltage components (i.e. less than 50V) do not typically require thermal vacuum testing if they can demonstrate structural integrity.
- f. If atmospheric thermal convection is required to prevent thermal overload of the component under test, testing shall be adjusted to reflect an MPE \pm 10°C thermal range for 3 times the worst-case thermal vacuum duration.

A3.2.5.9 EMI/EMC

RTS components shall not degrade in performance when subjected to radiated or conducted emissions from all flight vehicle systems and external ground transmitter sources. In addition,

these components shall not radiate or conduct an EMI to other range safety critical components (e.g. FTS), such that the performance of those components is degraded. The RTS receiver and support systems shall satisfy the following tailored requirements in all operational configurations (to include data traffic on any attached data cables) of MIL-STD-464 and MIL-STD-461E.

a. The RTS component shall meet all performance criteria stated in this document when collocated with other electronic equipment that does not violate the tailored requirements above. As a minimum the RTS components and accessories should comply with the following MIL-STD-461E requirements for Army Aircraft (Internal and external) except as noted: CE101, CE102, CE106, CS101, CS104, CS114, CS115, CS116, RE101 (Navy), RE102, RS101, and RS103. For RS103 the frequencies $L1 \pm 75$ MHz and $L2 \pm 75$ MHz shall be excluded.

b. Test setups and methods should be IAW MIL-STD-461E with the following exception for RE102: The remote antenna cable shall be zigzagged (sometimes called a serpentine pattern) vertically above and parallel to the ground plane on a non-conductive panel. The serpentine pattern should be constructed by first placing a length of cable at the bottom of the panel parallel to the ground plane and minimally five cm above it, and then reversing the direction of the cable run by 180 degrees each time a change of direction is required. At least five changes of direction are recommended. Individual segments of the cable are parallel and should be kept at least five cm apart. No coiling should be performed. The remote antenna should be located above the GPS receiver and in the same vertical plane as the GPS receiver. All other cables should be positioned IAW MIL-STD-461E.

c. Through experience, it has been found that if the RE102 cables are laid out per the specification, emissions can be shunted to ground and not detected. Therefore, we have tailored the RE102 remote antenna cable routing to represent a worst-case radiation configuration.

A3.2.5.10 Temperature Shock

Temperature shock testing shall demonstrate the ability of a component to withstand thermal environments with a high rate of thermal change.

- a.* Thermal testing shall ensure a minimum 10°C margin above the maximum predicted environment at low and high temperature.
- b.* Thermal dwell time and the number of thermal cycles shall be three times the MPE.
- c.* Thermal ramp rate shall be a minimum of the worse case MPE.
- d.* Thermal shock testing can be performed by analysis if operational thermal cycle ramp rate is a more conservative test.

A3.2.6 Acceptance Operating Environments

Acceptance Tests on the Flight Units are typically conducted at the range user/vendor facilities to demonstrate that each production end item meets the requirements of the specification and to reveal production inadequacies. Acceptance testing shall be performed on 100 percent of all RTS components and systems. This Acceptance Testing shall be identical to any User acceptance testing done on the Design Verification/Qualification Units. The acceptance test performance data will be used to evaluate "in-family" performance and item life cycle performance degradation. Components tested to the applicable requirements of this section

(as tailored in the test matrices) must meet all range safety performance requirements during and after all required testing.

A3.2.6.1 Random Vibration

Acceptance random vibration testing is performed to detect material/workmanship defects and validate RTS component survivability during flight MPEs by using the following criteria:

- a. The random vibration test level shall at the greater of MPE or ATP workmanship level (Table A3.2.6.1), from 20 Hz to 2000 Hz in each of the three orthogonal axes.
- b. For short duration missions, the test duration shall be at MPE or a minimum of 60 seconds per axis, in all three mutually perpendicular axes. For extended duration flights (e.g. captive carry), the vibration test duration shall not be less than 5 min per axis in all 3 mutually perpendicular axes.
- c. Acceptance testing shall be performed using identical test methods except the qualification margins and durations are removed.
- d. Where there is insufficient time at the full test level to test all functions and modes, extended testing at a level six dB lower can be conducted as necessary to complete functional testing.
- e. The test tolerance used should be ± 1.5 dB. If larger test tolerances are used, an appropriate factor shall be added to the qualification level to maintain the required margin between acceptance and qualification.

TABLE A3.2.6.1. MINIMUM POWER SPECTRAL DENSITY FOR ACCEPTANCE WORKMANSHIP RANDOM VIBRATION	
Frequency Range	Minimum PSD
20	0.0053 g ² /Hz
20-150	3 dB/Octave Slope
150-600	0.04 g ² /Hz
600-2000	-6 dB/Octave Slope
2000	0.0036 g ² /Hz
Overall G _{rms} = 6.1	

A3.2.6.2 Acoustic

Acceptance acoustic vibration testing is performed to detect material/workmanship defects and validate RTS component survivability during flight MPEs by using the following criteria:

- a. The acoustic vibration minimum test level shall at the MPE from 20 Hz to 2000 Hz.
- b. The test duration shall be at MPE or a minimum of 60 seconds in all three mutually perpendicular axes.
- c. Where there is insufficient time at the full test level to test all functions and modes, extended testing at a level six dB lower shall be conducted as necessary to complete functional testing.

d. Components may be acceptance tested by analysis if it can be shown that operating random vibration envelopes acceptance acoustic levels and durations.

e. The test tolerance used should be ± 1.5 dB or consistent with tolerances established as part of the qualification test margin.

A3.2.6.3 Acceleration

Acceptance acceleration testing is performed to detect material/workmanship defects and validate RTS component survivability during abnormal and nominal flight environments using the following criteria:

a. The acceleration test level shall be a minimum of the MPE or vehicle breakup level whichever is greater.

b. The duration of the acceleration shall be the MPE in each direction for each of the 3 orthogonal axes.

c. The test tolerance used shall be ± 10 percent or consistent with tolerances established as part of the qualification test margin

d. An analysis may be used that shows operational random vibration testing envelopes acceptance acceleration environments; for this analysis, random vibration statistics for peak G-levels versus time shall envelope acceptance acceleration levels and durations.

A3.2.6.4 Thermal Cycle

Acceptance thermal cycle testing is performed to detect material/workmanship defects and validate RTS component survivability during flight MPE's by using the following criteria:

Electronic Component.

a. The component thermal cycle range shall be at the MPE high temperature or 61°C , whichever is higher, and at the MPE low temperature or -24°C , whichever is lower.

b. The number of initial thermal acceptance cycles shall be a minimum of 18 cycles. Any retest due to rework/repair shall be tested to 8 cycles. Each cycle should have a 1-h minimum dwell at the high and low temperature levels during which the unit should be turned off until the temperature stabilizes and then turned on.

c. The dwell time at the high and low levels shall be long enough to obtain internal thermal equilibrium.

d. The test unit transitions between low and high temperatures should be at an average rate of at least 1°C per min or maximum expected rate, whichever is greater.

e. As applicable, the test unit shall be functional tested at the first, middle and last, hot and cold thermal dwell cycle at worst case low and high operating voltage. Critical parameters shall be monitor at the nominal operating voltage for other cycles and during thermal transition.

RF Component.

- a. The component thermal cycle range shall be at the MPE high temperature or 61°C, whichever is higher, and at the MPE low temperature or -24°C, whichever is lower.
- b. The number of thermal cycles shall be a minimum of 8 cycles. Each cycle should have a 1-h minimum dwell at the high and low temperature levels.
- c. The dwell time at the high and low levels shall be long enough to obtain internal thermal equilibrium.
- d. The test unit transitions between low and high temperatures should be at an average rate of at least 1°C per min or maximum expected rate, whichever is greater.
- e. As applicable, the test unit shall be functional tested at the first, middle and last, hot and cold thermal dwell cycle. Critical parameters shall be monitor for other cycles and during thermal transition.

A3.2.6.5 Thermal Vacuum (Temperature Altitude)

Acceptance thermal altitude testing is performed to detect material/workmanship defects and validate RTS component survivability during flight MPE's by using the following criteria:

- a. The component temperature shall be at the maximum flight predicted high temperature or 61°C, whichever is higher and at the maximum flight predicted low temperature or -24°C, whichever is lower.
- b. The pressure gradient shall reflect the expected rate of altitude change which will be experienced during flight. The final vacuum dwell shall be sufficiently long to ensure the component under test has the opportunity to achieve pressure equilibrium.
- c. The number of thermal cycles shall be the expected thermal altitude cycles while the component is within Range Safety responsibility. These thermal cycles shall be performed during final vacuum dwell.
- d. The component under test shall be operated at maximum power and critical parameters monitored during chamber pressure reduction and final vacuum dwell. Functional tests shall be performed at worst-case high and low voltages.
- e. To utilize an analysis in lieu of a test will require demonstration that the component is not susceptible to workmanship corona, arcing, functional degradation or structural failure. Components that are environmentally sealed and 100 percent tested to verify the seal usually do not require acceptance thermal vacuum for short duration missions.

A3.3.1 RF Acceptance and Qualification Tests

See Tables A3-1 and A3-2 for Acceptance and Qualification Tests.

A3.3.1.1 Grounding (R)

Measure all external conductive parts of the antenna system to verify that they are at ground potential in accordance with the component specification.

A3.3.1.2 Impedance and VSWR (R)

Measure the impedance and a VSWR over the frequency bands for both L-band and RF downlink RF components. The voltage standing wave ratio (VSWR) should be less than 2.0:1 when excited from a source with the same impedance at the assigned frequencies. Antenna systems with a higher VSWR shall obtain specific Range Safety approval. Specifically, the cause of the high VSWR shall be identified and special design and/or test requirements may be imposed.

A3.3.1.3 Polarization (R)

Perform test to demonstrate the component compatibility with the on-axis and circular polarization specifications. The polarization should be within specified limits.

A3.3.1.4 Insertion Loss (R)

Measure the antenna system insertion loss. Verify the insertion loss is within the specification limits.

A3.3.1.5 RF Isolation (Couplers only) (R)

Measure the isolation between the RF junction ports. Verify the isolation is within the specification limit. Expected value for this specification would be minimum 25 dB between ports.

A3.3.1.6 Antenna Patterns (R)

- a. Perform antenna pattern measurements in accordance with RCC Document 253.
- b. Compare the pre-qualification test pattern data to the post-qualification test pattern to determine if a significant change has occurred in the antenna pattern. **Note:** A significant change is defined as more than 3 dB change over the 95 percent spherical coverage.
- c. Antenna pattern parameters shall support the capability to achieve specification track during range safety responsibility.

A3.3.1.7 Pull Test (R)

- a. The RF cables should be subjected to a qualification pull test of 30 lb for one minute, and four torque tests of 15 in-lbs for one minute.
- b. The RF cables should be subjected to an acceptance pull test of 15 lb for one minute, and four torque tests of 7.5 in-lbs for one minute.
- c. RF cables should perform within specification and exhibit no physical anomalies that would indicate the cables have been stressed.

A3.3.1.8 Passband (R)

- a. Step input signal across L-Band bandpass range. Record frequency response on spectrum analyzer.
- b. Amplitude ripple (peak-to-valley ratio) and 3dB/60dB bandwidth are typical measurements.
- c. The antenna system passband shall demonstrate margin over expected operational variations including Doppler shift, flight hardware manufacturing tolerances and antenna performance variations due to temperature. The antenna system passband should also minimize the effect of interference from other transmitting sources.

TABLE A3-1. RF SYSTEM ACCEPTANCE TEST MATRIX					
TEST	TEST REQUIREMENT	QUANTITY TESTED			
		CABLE	COUPLER	Antenna L-Band	Antenna RF Downlink
Product Examination	3.2.1				
Visual Inspection	A3.2.1.1	100%	100%	100%	100%
Dimension	A3.2.1.2	100%	100%	100%	100%
Identification	A3.2.1.3	100%	100%	100%	100%
Functional Tests (a)	3.1.6				
Impedance/VSWR	A3.3.1.2	100%	100%	100%	100%
Insertion Loss	A3.3.1.4	100%	100%		
Pass band	A3.3.1.8			100%	
RF Isolation	A3.3.1.5		100%	100% (b)	100% (b)
Reference Functional Test (c)	3.1.11				
Impedance/VSWR	A3.3.1.2	100%	100%	100%	100%
Operating Environment Tests	3.2.6				
Thermal Cycling	A3.2.6.4		100%	100%	100%
Thermal Vacuum	A3.2.6.5	100%	100%	100%	100%
Acceleration	A3.2.6.3		100%	100%	100%
Acoustic	A3.2.6.2		100%	100%	100%
Random Vibration	A3.2.6.1		100%	100%	100%
Pull Test	A3.3.1.7	100%			
Leakage (d)	A3.2.1.5		100%	100%	100%
<p>(a) These tests should be performed prior to and after each environmental test.</p> <p>(b) Only applicable to multi-port antennas</p> <p>(c) This test should be performed during operating environmental tests.</p> <p>(d) This test should be performed after the last operating environment test.</p>					

TABLE A3-2. RF SYSTEM QUALIFICATION TEST MATRIX

TEST	TEST REQUIREMENT	Coupler Quantity	RF Downlink Quantity	L-band Antenna Quantity
		1	1	1
Acceptance	Matrix A3-1	X	X	X
Antenna Patterns (a)	A3.3.1.6	X	X	X
Functional Tests (b)	3.1.6			
Grounding (e)	A3.3.1.1	X	X	X
Impedance/VSWR	A3.3.1.2	X	X	X
Polarization	A3.3.1.3	X	X	X
Insertion loss	A3.3.1.4	X	X	
RF Isolation (f)	A3.3.1.5	X	X	X
Passband	A3.3.1.8	X	X	X
Reference Functional Test (c)	3.1.11			
Impedance/VSWR	A3.3.1.2	X	X	X
Non-Operating Environment Tests	3.2.4			
Storage Temperature	A3.2.4.1	X	X	X
Transportation Shock	A3.2.4.2	X	X	X
Bench Handling	A3.2.4.3	X	X	X
Transportation Vibration	A3.2.4.4	X	X	X
Fungus Resistance	A3.2.4.5	X	X	X
Salt Fog	A3.2.4.6	X	X	X
Fine Sand	A3.2.4.7	X	X	X
Operating Environment Tests	3.2.5			
Thermal Cycling	A3.2.5.7	X	X	X
Humidity	A3.2.5.6	X	X	X
Thermal Vacuum	A3.2.5.8	X	X	X
Acceleration	A3.2.5.5	X	X	X
Shock	A3.2.5.4	X	X	X
Sinusoidal Vibration	A3.2.5.1	X	X	X
Acoustic	A3.2.5.3	X	X	X
Random Vibration	A3.2.5.2	X	X	X
EMI/EMC	A3.2.5.9	X	X	X
Temperature Shock	A3.2.5.10	X	X	X
Leakage (d)	A3.2.1.5	X	X	X
Disassembly	A3.2.1.4	X	X	X
<p>(a) This test should only be performed prior to environmental testing and after all environmental testing has been completed.</p> <p>(b) These tests should be performed prior to and after each environmental test.</p> <p>(c) This test should be performed during the operating environment tests.</p>				

A3.3.2 Global Positioning System Receiver Test Requirements

A3.3.2.1 Continuity and Isolation (R)

- a. Verify that the component continuity and isolation resistance between the case ground and all power leads, and signal outputs, including returns, and between power leads and signal leads, including returns are within the requirements that are specified in the component specification.
- b. Resistance values should be within specification.

A3.3.2.2 DC Input Voltage (R) (A) (S) (L)

- a. Verify proper operation at specified voltage range. For example, 24, 28, and 32 VDC.
- b. RTS receiver shall perform within specification throughout the specification voltage range.
- c. For qualification, this test should include a reverse polarity protection test.

A3.3.2.3 Input Current (R)

- a. Measure current at low, nominal, and high supply voltage. During dynamic environmental testing, input current should be continuously monitored at a 1 ms resolution.
- b. Input current values shall remain within specification throughout testing. Input current shall not fluctuate during dynamic environmental testing.

A3.3.2.4 Noise Figure (R)

- a. Determine noise figure at the Low Noise Amplifier (LNA) output.
- b. Use noise figure meter to make measurements. This is typically a one-time circuit-board level test to validate design concepts. Noise figure should be within specification.

A3.3.2.5 Phase Linearity (R) (A)

- a. Determine rate of change of phase as function of frequency across operating bandwidth. This test checks differential delay across operational bandwidth.
- b. Input CW L-band signal and measure rate of change of phase across the main lobe bandwidth frequencies. This measurement should be taken from the output of the RF front-end.
- c. This is typically a one-time circuit-board level test to validate design concepts. Phase linearity should be within specification.

A3.3.2.6 Sensitivity

Sensitivity testing shall determine the C/N_0 , at which the receiver performs within specification. This sensitivity value is used as part of the L-band link analysis to determine which satellites in view can be used to generate a solution. This test can be performed using the

real-time “live” satellite network with an RF attenuator or use Test 2 of the dynamic simulation described in paragraph A3.1.7 for this test.

A3.3.2.7 RF Overload (R)

- a. Verify that the component can withstand a specification-level RF overload at expected operational frequencies of worst-case duration.
- b. GPS receiver shall perform within specification after application of RF overload test.

A3.3.2.8 Reacquisition Test (R)

- a. Determine the reacquisition time in a static environment. Input a GPS constellation through a satellite simulator or a “live” constellation and attenuate the L-band signal to cause the receiver to lose lock on all channels. This test should be performed with a dropout of 30 seconds. Determine amount of time to provide a valid tracking solution after the L-band signal is restored.
- b. Determine the reacquisition time in a flight vehicle environment. Reacquisition tests should be performed using worst-case flight vehicle C/N_0 values at acceleration and velocity environments representative of nominal flight vehicle environments. If flight vehicle C/N_0 values are not available, the tracking threshold sensitivity should be used. The dropout time should reflect worst-case mission induced events.
- c. These tests should be performed a sufficient number of times to characterize performance variability.
- d. This test determines the amount time it takes to reacquire a tracking solution given a loss of L-band signal. The value measured will be used by Range Safety to determine whether there can be an unacceptable loss of tracking during flight vehicle events (e.g. staging and fairing separation). The reacquisition time shall be within its performance specification.

A3.3.2.9 Receiver Autonomous Integrity Monitoring (R)(A)

- a. GPS receivers with RAIM should be tested to verify the capability to autonomously detect and reject a satellite that is out-of-specification regardless of the space vehicle health status.
- b. This test should be performed on a satellite simulator with one satellite providing out-of-specification data.
- c. The GPS receiver shall perform within specification throughout this test

A3.3.2.10 De-selection of Faulty Satellites (R) (A)

- a. Verify the GPS receiver can deselect a faulty satellite for which a space vehicle health bit has been set.
- b. Setting the space vehicle health bits for one satellite to indicate that the satellite is out shall perform this test. The GPS receiver shall read health bit and deselect the satellite.
- c. The GPS receiver shall perform within specification throughout this test.

A3.3.2.11 Immunity to In-Band and Out-of-Band Interfering Signals (R)

a. Verify that the GPS receiver is capable of functioning within the required range safety performance parameters when exposed to worst-case ground and vehicle induced RF interference.

b. Measure reduction in C/N_0 as a function of specification-level noise input. One suggested approach is to utilize a live constellation or simulator to allow GPS component tracking at a known signal level. Interfering noise can then be introduced into the system until the GPS component no longer functions.

c. GPS receiver shall perform within specification when subjected to expected range and launch vehicle interfering signals.

A3.3.2.12 Reference Functional Dynamic Simulation (R) (A) (M) (S) (Q) (L)

Perform dynamic simulation TEST 2 and TEST 3 described in paragraph A3.1.7 to establish a baseline to be compared to environmental and post-environmental performance.

TEST 1, paragraph A3.1.7, shall be performed prior to flight and shall simulate the vehicle flight configuration and trajectory (e.g. antenna patterns and moment arms). This test does not need to be performed with a qualification or acceptance test unit. It may be possible to include worst-case trajectories and other vehicle parameters into a one-time series of tests. This testing could allow a family of launch constraints to be enveloped and avoid reperforming tests for each launch.

A3.3.2.13 Peak Input Voltage (R)

a. Verify that unit can withstand specification-level transient peak input voltage.

b. The GPS receiver shall function within specification after being subjected to the peak input transient voltage test.

TABLE A3-3A. RF SYSTEM QUALIFICATION TEST MATRIX		
TEST	TEST REQUIREMENT	QUANTITY TESTED
Product Examination	3.2.1	
Visual	A3.2.1.1	100%
Dimension	A3.2.1.2	100%
Identification	A3.2.1.3	100%
Functional Test (a)	3.1.6	
Reference Functional Dynamic Simulation	A3.3.2.13	100%
Continuity & Isolation	A3.3.2.1	100%
DC Input Voltage	A3.3.2.2	100%
Input Current	A3.3.2.3	100%
Sensitivity	A3.3.2.6	100%
Reacquisition	A3.3.2.8	100%
RAIM	A3.3.2.9	100%
De-selection of Faulty Satellites	A3.3.2.10	100%
Immunity to In-Band and Out-of-Band Interfering Signals	A3.3.2.11	100%
Reference Functional Test (c)	3.1.11	100%
Input Current	A3.3.2.3	100%
Operating Environment Tests	3.2.6	
Thermal Cycling (d)	A3.2.6.4	100%
Thermal Vacuum (d)	A3.2.6.5	100%
Acceleration (e)	A3.2.6.3	100%
Acoustic (e)	A3.2.6.2	100%
Random Vibration (e)	A3.2.6.1	100%
Leakage (b)	A3.2.1.5	100%
<p>(a) These tests should be performed before and after each environmental test.</p> <p>(b) This test should be performed after the last operating environment test.</p> <p>(c) These tests should be performed during the operating environment tests.</p> <p>(d) Perform dynamic simulation, TEST 2, paragraph A3.1.7 during the hot and cold thermal dwells of the first and last thermal cycle. TEST 3 of paragraph A3.1.7 should be used during the thermal ramps.</p> <p>(e) Perform dynamic simulation, TEST 3, paragraph A3.1.7</p>		

TABLE A3-4A. GPS RECEIVER TEST REQUIREMENTS QUALIFICATION TEST

TEST	TEST REQUIREMENT	QUANTITY TESTED
		1
Acceptance Testing	TABLE A3-3a	X
Functional Test (a)	3.1.6	
Reference Functional Dynamic Simulation	A3.3.2.13	X
Continuity & Isolation	A3.3.2.1	X
DC Input Voltage	A3.3.2.2	X
Input Current	A3.3.2.3	X
Noise Figure	A3.3.2.4	X
Phase Linearity	A3.3.2.5	X
Sensitivity	A3.3.2.6	X
RF Overload (b)	A3.3.2.7	X
Reacquisition	A3.3.2.8	X
RAIM	A3.3.2.9	X
De-selection of Faulty Satellites	A3.3.2.10	X
Immunity to In-Band and Out-of-Band Interfering Signals	A3.3.2.11	X
Peak Input Voltage (b)	A3.3.2.14	X
Reference Functional Test (d)	3.1.11	
Input Current	A3.3.2.3	X
Non-Operating Environmental Tests	3.2.4	
Storage Temperature	A3.2.4.1	X
Transportation Shock	A3.2.4.2	X
Bench Handling	A3.2.4.3	X
Transportation Vibration	A3.2.4.4	X
Fungus Resistance	A3.2.4.5	X
Salt-Fog	A3.2.4.6	X
Fine Sand	A3.2.4.7	X
Operating Environment Tests	3.2.5	
Thermal Cycling (e)	A3.2.5.7	X
Humidity (e)	A3.2.5.6	X
Thermal Vacuum (e)	A3.2.5.8	X
Acceleration (f)	A3.2.5.5	X
Shock (f)	A3.2.5.4	X
Sinusoidal Vibration (f)	A3.2.5.1	X
Acoustic (f)	A3.2.5.3	X
Random Vibration (f)	A3.2.5.2	X
EMI/EMC	A3.2.5.9	X
Explosive Atmosphere (f)		
Thermal Shock (e)	A3.2.5.10	X
Leakage (c)	A3.2.1.5	X
Disassembly	A3.2.1.4	X
<p>(a) These tests should be performed before and after environments are completed.</p> <p>(b) One time test.</p> <p>(c) This test should be performed after the last non-operating and last operating environmental tests.</p> <p>(d) These tests should be performed during operating environmental tests.</p> <p>(e) Perform dynamic simulation, TEST 2, paragraph A3.1.7 during the hot and cold thermal dwells of the first, middle and last thermal cycles. TEST 3 of paragraph A3.1.7 should be used during the thermal ramps.</p> <p>(f) Perform dynamic simulation, TEST 2, paragraph A3.1.7.</p>		

A3.3.3 Global Positioning System Translator Test Requirements

A3.3.3.1 Continuity and Isolation (R)

a. Verify that the component continuity and isolation resistance between the case ground and all power leads, and signal outputs, including returns, and between power leads and signal leads, including returns are within the requirements that are specified in the component specification.

b. Resistance values should be within specification.

A3.3.3.2 DC Input Voltage (R) (A) (S) (L)

a. Verify proper operation at specified voltage range. For Example 24, 28, and 32 VDC.
b. GPS translator shall perform within specification throughout the specification voltage range.

c. For qualification, this test should include a reverse polarity protection test.

A3.3.3.3 Input Current (R)

a. Measure current at low, nominal, and high supply voltage. During dynamic environmental testing, input current should be continuously monitored at a 1 ms resolution.

b. Input current values should remain within specification throughout testing. Input current shall not fluctuate during dynamic environmental testing.

A3.3.3.4 Noise Figure (R)

a. Use noise figure meter to make measurements.

b. This is typically a one-time circuit-board level test to validate design concepts. Noise figure should be within specification.

A3.3.3.5 Phase Linearity (R) (A)

a. Measure rate of change of phase as a function of frequency across main lobe bandwidth.

b. This test checks differential delay across operational bandwidth.

c. This is typically a one-time “board level” test to validate design concepts. Phase linearity should be within specification.

A3.3.3.6 Maximum Dynamic Range (R)

a. The translator shall be tested with a GTP to ensure it functions within its performance specification when subjected to the minimum and maximum RF L-band input. Varying a live L-band GPS signal into the translator and measuring the state vector accuracy of the GTP should perform this test.

b. The GTP solution shall be within its performance specification through all specification values of translator L-band input.

A3.3.3.7 Frequency Accuracy (R)

a. Measure the frequency accuracy of the output transmitted signal.

b. The frequency accuracy shall be within specification and in-family. The expected value for this specification is 20 parts-per-million of design center frequency.

A3.3.3.8 Peak Input Voltage (R)

a. Verify that unit can withstand specification-level transient peak input voltage.

b. The GPS translator shall function within specification after being subjected to the peak input transient voltage test.

A3.3.3.9 RF Overload (R)

a. Verify that unit can withstand a specification-level RF overload of specified duration.

b. GPS translator shall perform within specification after application of RF overload test.

A3.3.3.10 Frequency Stability (R)

a. Measure the frequency stability of the output transmitted signal. The frequency stability shall be within specification and in-family.

A3.3.3.11 Data Transfer (R) (M) (A) (S) (Q)

The translator shall be tested to ensure it has adequate dynamic range and can reliably and accurately transfer data.

It is recommended to use dynamic simulation TEST 2 and TEST 3 (see paragraph A3.1.7) to establish a baseline to be compared to environmental and post-environmental performance.

TEST 1, paragraph A3.1.7, shall be performed prior to flight and shall simulate the vehicle flight configuration and trajectory (e.g. antenna patterns and moment arms) into an identical GTP being used for flight. It may be possible to include worst-case trajectories and other vehicle parameters into a one-time series of tests. This testing would allow a family of launch constraints to be enveloped and avoid reperforming tests for each launch.

A3.3.3.12 Power Output (R)

- a.* Measure the 3 dB and 60 dB power output of the transmitted signal.
- b.* The output power shall be within specification and in-family. Power output is used as a status-of-health test for the transmitter.

A3.3.3.13 Carrier Phase Noise (R)

- a.* Measure the carrier phase noise of the transmitted signal.
- b.* The carrier phase noise shall be within specification and in-family. The expected value for a 0.1 sec single Allan variance is better than 1 part in 10 to the 10th.

A3.3.3.14 Authorized Bandwidth and Spurious Emissions (R)

- a.* Measure the authorized transmitter bandwidth and any spurious emissions that are present.
- b.* The RF output shall be within specification and not degrade the performance of other vehicle functions including the FTS.

TABLE A3-3B. GPS TRANSLATOR TEST REQUIREMENTS ACCEPTANCE TEST (b)		
TEST	TEST REQUIREMENT	QUANTITY TESTED
Product Examination	3.2.1	
Visual	A3.2.1.1	100%
Dimension	A3.2.1.2	100%
Identification	A3.2.1.3	100%
Receiver Functional Test (a)	3.1.6	
Maximum Dynamic Range	A3.3.3.6	100%
Continuity & Isolation	A3.3.3.11	100%
DC Input Voltage	A3.3.3.1	100%
Input Current	A3.3.3.3	100%
Transmitter Functional test (g)	3.1.6	
Frequency Accuracy	A3.3.3.7	100%
Frequency Stability	A3.3.3.10	100%
Power Output	A3.3.3.12	100%
Reference Functional Test (c)	3.1.11	
Input Current	A3.3.3.3	100%
Power Output	A3.3.3.12	100%
Frequency Stability (g)	A3.3.3.10	100%
Operating Environment Tests	3.2.6	
Thermal Cycling (d)	A3.2.6.4	100%
Thermal Vacuum (d)	A3.2.6.5	100%
Acceleration (e)	A3.2.6.3	100%
Acoustic (e)	A3.2.6.2	100%
Random Vibration (e)	A3.2.6.1	100%
Leakage (f)	A3.2.1.5	100%
<p>(a) These tests should be performed before and after each environmental test.</p> <p>(b) Translators should be acceptance tested with a GTP, though it may be possible to demonstrate data transfer by other means.</p> <p>(c) These tests should be performed during the operating environment tests.</p> <p>(d) Perform dynamic simulation, TEST 2, paragraph A3.1.7 during the hot and cold thermal dwells of the first and last thermal cycle. TEST 3 of paragraph A3.1.7 should be used during the thermal ramps. This test shall be done with a GTP.</p> <p>(e) Perform dynamic simulation, TEST 3, paragraph A3.1.7. This test should be done with a GTP.</p> <p>(f) This test should be performed after the last operating environment test.</p> <p>(g) These requirements are applicable to translators that are integrated with a TM down-link system</p>		

**TABLE A3-4B. GPS TRANSLATOR
TEST REQUIREMENTS ACCEPTANCE TEST (B)**

TEST	TEST REQUIREMENT	QUANTITY TESTED 1
Acceptance Test	Table A3-3b	
Receiver Functional Test (a)	3.1.6	
Reference Functional Dynamic Simulation	A3.3.2.14	X
Noise Figure	A3.3.3.4	X
Phase Linearity	A3.3.3.5	X
Peak Input Voltage	A3.3.3.14	X
RF Overload	A3.3.3.7	X
Data Transfer	A3.3.3.11	X
Transmitter Functional Test (g)	3.1.6	
Carrier Phase Noise	A3.3.3.13	X
Authorized Bandwidth and Spurious Emissions	A3.3.3.14	X
Reference Functional Test (c)	3.1.11	
Input Current	A3.3.3.3	X
Power Output (g)	A3.3.3.12	X
Frequency Stability (g)	A3.3.3.10	X
Data Transfer	A3.3.3.11	X
Non-Operating Environmental Tests	3.2.4	
Storage Temperature	A3.2.4.1	X
Transportation Shock	A3.2.4.2	X
Bench Handling	A3.2.4.3	X
Transportation Vibration	A3.2.4.4	X
Fungus Resistance	A3.2.4.5	X
Salt-Fog	A3.2.4.6	X
Fine Sand	A3.2.4.7	X
Operating Environment Tests	3.2.5	
Thermal Cycling (d)	A3.2.5.7	X
Humidity (d)	A3.2.5.6	X
Thermal Vacuum (d)	A3.2.5.8	X
Acceleration (e)	A3.2.5.5	X
Shock (e)	A3.2.5.4	X
Sinusoidal Vibration (e)	A3.2.5.1	X
Acoustic (e)	A3.2.5.3	X
Random Vibration (e)	A3.2.5.2	X
EMI/EMC	A3.2.5.9	X
Thermal Shock	A3.2.5.10	X
Leakage (f)	A3.2.1.5	X
Disassembly	A 3.2.1.4	X

- (a) These tests should be performed before and after each environmental test.
- (b) Translators shall be qualification tested with a GTP. Translators that are integrated with a TM downlink system shall also meet the TM downlink requirements described in Tables A3-3c and A3-4c.
- (c) These tests should be performed during all operating environment tests.
- (d) Perform dynamic simulation, TEST 2, paragraph A3.1.7 during the hot and cold thermal dwells of the first, middle and last thermal cycles. TEST 3 of paragraph A3.1.7 should be used during the thermal ramps. This test shall be done with a GTP.
- (e) Perform dynamic simulation, TEST 2, paragraph A3.1.7. This test shall be done with a GTP.
- (f) This test should be performed after the last operating environment test.
- (g) These requirements are applicable to translators that are integrated with a TM downlink system

A3.3.4 RF Downlink Transmitter Test Requirements

A3.3.4.1 Continuity & Isolations (R)

a. Verify that the down link system continuity and isolation resistance between the case ground and all power leads, and signal outputs, including returns, and between power leads and signal leads, including returns are within the requirements that are specified in the component specification.

b. Resistance values should be within specification.

A3.3.4.2 Power Output (R)

a. Measure the power output from the transmitter after a specified warm-up period.

b. The power output shall remain within specification throughout all acceptance and qualification tests.

A3.3.4.3 Frequency Stability (R)

a. Measure the center frequency of the transmitter after a specified warm-up period.

b. The center frequency shall remain within specification throughout all acceptance and qualification tests.

A3.3.4.4 Authorized Bandwidth and Spurious Emissions (R)

a. Measure the authorized transmitter 3 dB and 60 dB bandwidth and any spurious emissions that are present.

b. The RF output shall be within specification and not degrade the performance of other vehicle functions including the FTS.

Note: During this test the transmitter output carrier frequency should be modulated in accordance with the flight operational modulation scheme. For example, if the modulation scheme employs phase shift keying (PSK), the carrier should be PSK modulated using an operationally representative input (bit rate, return-to-zero scheme, and state transitions over time).

A3.3.4.5 Carrier Suppression (R)

a. Measure the amount of carrier that is present in the RF signal.

b. When applicable, carrier suppression measured should be within specification and used as a status-of-health indication.

A3.3.4.6 DC Input Voltage (R) (A) (S) (L)

a. Verify proper operation at specified voltage range. Example 24, 28, and 32 VDC.

b. TM transmitter shall perform within specification throughout the specification voltage range.

c. For qualification, this test should include a reverse polarity protection test.

A3.3.4.7 Carrier Phase Noise (R)

- a. Measure the carrier phase noise of the transmitted signal.
- b. The carrier phase noise shall be within specification and in-family. The expected value for a 0.1 sec single Allan variance is better than 1 part in 10 to the 10th.

TABLE A3-3C. RF DOWNLINK TRANSMITTER ACCEPTANCE TEST MATRIX		
TEST	TEST REQUIREMENT	QUANTITY TESTED
Product Examination	3.2.1	
Visual	A3.2.1.1	100%
Dimension	A3.2.1.2	100%
Identification	A3.2.1.3	100%
Functional Tests (a)	3.1.6	
DC Input Voltage	A3.3.4.6	100%
Continuity & Isolation	A3.3.4.1	100%
Power Output	A3.3.4.2	100%
Frequency Stability	A3.3.4.3	100%
Authorized Bandwidth and Spurious Emissions	A3.3.4.4	100%
Carrier Suppression	A3.3.4.5	100%
Reference Functional Tests (b)	3.1.11	
DC Input Voltage	A3.3.4.6	100%
Power Output	A3.3.4.2	100%
Frequency Stability	A3.3.4.3	100%
Operating Environment Tests	3.2.6	
Thermal Cycling (d)	A3.2.6.4	100%
Thermal Vacuum (d)	A3.2.6.5	100%
Acceleration	A3.2.6.3	100%
Acoustic	A3.2.6.2	100%
Random Vibration	A3.2.6.1	100%
Leakage (c)		100%
<p>(a) These tests should be performed prior to and after each environmental test. (b) These should be monitored during the operating environment tests. (c) This test should be performed after the last operating environment test. (d) Perform reference functional tests, during the hot and cold thermal dwells of the first and last thermal cycles. Reference functional tests should also be performed during the thermal ramps.</p>		

TABLE A3-4C. RF DOWNLINK TRANSMITTER QUALIFICATION TEST MATRIX		
TEST	TEST REQUIREMENT	QUANTITY TESTED 1
Acceptance	Matrix 3-3c	X
Functional Tests (a)	3.1.6	
DC Input Voltage	A3.3.4.6	X
Continuity & Isolation	A3.3.4.1	X
Power Output	A3.3.4.2	X
Frequency Stability	A3.3.4.3	X
Authorized Bandwidth and Spurious Emissions	A3.3.4.4	X
Carrier Suppression	A3.3.4.5	X
Carrier Phase Noise	A3.3.4.7	X
Reference Functional Tests (b)	3.1.11	
DC Input Voltage	A3.3.4.6	X
Power Output	A3.3.4.2	X
Frequency Stability	A3.3.4.3	X
Non-Operating Environmental Tests	3.2.4	
Storage Temperature	A3.2.4.1	X
Transportation Shock	A3.2.4.2	X
Bench Handling	A3.2.4.3	X
Transportation Vibration	A3.2.4.4	X
Fungus Resistance	A3.2.4.5	X
Salt-Fog	A3.2.4.6	X
Fine Sand	A3.2.4.7	X
Operating Environment Tests	3.2.5	
Thermal Cycling (d)	A3.2.5.7	X
Humidity	A3.2.5.6	X
Thermal Vacuum (e)	A3.2.5.8	X
Acceleration	A3.2.5.5	X
Shock	A3.2.5.4	X
Sinusoidal Vibration	A3.2.5.1	X
Acoustic	A3.2.5.3	X
Random Vibration	A3.2.5.2	X
EMI/EMC	A3.2.5.9	X
Thermal Shock	A3.2.5.10	X
Leakage (c)	A3.2.1.5	X
Disassembly	A3.2.1.4	X
<p>(a) These tests should be performed prior to and after each environmental test. (b) These should be monitored during the operating environment tests. (c) This test should be performed after the last non-operating and the last operating environment test. (d) Perform reference functional tests during the hot and cold thermal dwells of the first, middle and last thermal cycles. Reference functional tests should also be performed during the thermal ramps.</p>		

TABLE A3-3D. MISCELLANEOUS COMPONENT ACCEPTANCE TEST MATRIX (INCLUDES ENCODERS, MULTIPLEXERS AND SIGNAL CONDITIONERS)

TEST	TEST REQUIREMENT	QUANTITY TESTED
Product Examination	3.2.1	
Visual	A3.2.1.1	100%
Dimension	A3.2.1.2	100%
Identification	A3.2.1.3	100%
Functional Test (a)	3.1.6	100%
Reference Functional Test (b)	3.1.11	100%
Operating Environment Tests (e)	326	
Thermal Cycling (c)	A3.2.6.4	100%
Thermal Vacuum (c)	A3.2.6.5	100%
Acceleration (e)	A3.2.6.3	100%
Acoustic (e)	A3.2.6.2	100%
Random Vibration (e)	A3.2.6.1	100%
Leakage (d)	A.3.2.1.5	100%
<p>(a) These tests should be performed prior to and after all environment tests have been completed.</p> <p>(b) These tests should be performed during operating environment tests.</p> <p>(c) Perform functional tests, during the hot and cold thermal dwells of the first and last thermal cycles. Reference functional tests should be performed during the thermal ramp.</p> <p>(d) This test should be performed after the last operating environment test.</p> <p>(e) Reference functional tests should be performed during these tests.</p>		

**TABLE A3-4D. MISCELLANEOUS COMPONENT ACCEPTANCE TEST MATRIX
(INCLUDES ENCODERS, MULTIPLEXERS AND SIGNAL CONDITIONERS)**

TEST	TEST REQUIREMENT	QUANTITY TESTED 1
Acceptance	Table A3-3d	X
Functional Test (a)	3.1.6	X
Reference Functional Test (c)	3.1.11	X
Non-Operating Environmental Tests	3.2.4	
Storage Temperature	A3.2.4.1	X
Transportation Shock	A3.2.4.2	X
Bench Handling	A3.2.4.3	X
Transportation Vibration	A3.2.4.4	X
Fungus Resistance	A3.2.4.5	X
Salt-Fog	A3.2.4.6	X
Fine Sand	A3.2.4.7	X
Operating Environment Tests(b)	3.2.5	
Thermal Cycling (d)	A3.2.5.7	X
Humidity(d)	A3.2.5.6	X
Thermal Vacuum (d)	A3.2.5.8	X
Acceleration (b)	A3.2.5.5	X
Shock(b)	A3.2.5.4	X
Sinusoidal Vibration(b)	A3.2.5.1	X
Acoustic(b)	A3.2.5.3	X
Random Vibration(b)	A3.2.5.2	X
EMI/EMC	A3.2.5.9	X
Thermal Shock (b)	A3.2.5.10	X
Leakage (e)	A3.2.1.5	X
Disassembly	A3.2.1.4	X

- (a) These tests should be performed prior to and after all environment tests have been completed.
- (b) Reference functional tests should be performed during these tests.
- (c) These tests should be performed during operating environment tests.
- (d) Perform reference functional tests, during the hot and cold thermal dwells of the first, middle and last thermal cycles. Reference functional tests should be performed during the thermal ramp.
- (e) This test should be performed after the last non-operating and the last operating environment tests.

TABLE A3-3E. INERTIAL MEASUREMENT UNIT TEST REQUIREMENTS ACCEPTANCE TEST (a)		
TEST	TEST REQUIREMENT	QUANTITY TESTED
Instrument Level Tests (b)	Table A3-3g-1 Table A3-3g-2	100% 100%
Product Examination	3.2.1	
Visual	A3.2.1.1	100%
Dimension	A3.2.1.2	100%
Identification	A3.2.1.3	100%
Functional Test (c)	A3.1.6	
DC Input Voltage	A3.3.5.3.2	100%
Input Current	A3.3.5.3.3	100%
Continuity & Isolation	A3.3.5.3.1	100%
Navigation Functional Test (d)	A3.3.5.3.4	100%
Reference Functional Tests (e)	A3.1.11	
Input Current (f)	A3.3.5.3.3	100%
Monitor – Navigation Solution and Velocity Errors	A3.3.5.3.6	100%
Operating Environment Tests	A3.2.6	
Thermal Cycling	A3.2.6.4	100%
Thermal Vacuum	A3.2.6.5	100%
Random Vibration	A3.2.6.1	100%
Acceleration	A3.2.6.3	100%
Acoustic Noise	A3.2.6.2	100%
Leakage (g)	A3.2.1.5	100%
<p>(a) These tests are a candidate list; selection of tests for an individual program will depend on specific design and operations considerations. The listed test regime includes the maximum use of functional testing before and after environments; programs may choose to limit or defer these test until the completion of all environment tests. Use of the full regime provides the best opportunity to pinpoint the cause of failures that may occur during environments.</p> <p>(b) These tests are run at the sub-assembly instrument level prior to integrating into the IMU.</p> <p>(c) These tests shall be performed before and after environments. Compare results to determine if there is any degradation in performance.</p> <p>(d) This Functional Test should be performed before and after all Operating Environment Tests.</p> <p>(e) These tests shall be performed during environment test.</p> <p>(f) This Reference Functional Test should be performed during each Operating Environment Test.</p> <p>(g) This test shall be performed after the last non-operating and last operating environmental tests.</p>		

TABLE A3-4E. INERTIAL MEASUREMENT UNIT TEST REQUIREMENTS QUALIFICATION TEST (a)		
TEST	TEST REQUIREMENT	QUANTITY TESTED 1
Instrument Level Acceptance Tests (b)	Table A3-3g-1 Table A3-3g-2	X X
Product Examination	3.2.1	
Visual	A3.2.1.1	X
Dimension	A3.2.1.2	X
Identification	A3.2.1.3	X
Functional Test (c)	A3.1.6	
DC Input Voltage	A3.3.5.3.2	X
Input Current	A3.3.5.3.3	X
Continuity & Isolation	A3.3.5.3.1	X
Navigation Functional Test (d)	A3.3.5.3.4	X
Other Functional Tests		
Sensor Performance Test (d)	A3.3.5.3.5	X
Reference Functional Tests (e)	A3.1.11	
Input Current	A3.3.5.3.3	X
Monitor – Navigation Solution and Velocity Errors	A3.3.5.3.6	X
Functional Test (c)	A3.1.6	
DC Input Voltage	A3.3.5.3.2	X
Input Current	A3.3.5.3.3	X
Continuity & Isolation	A3.3.5.3.1	X
Navigation Functional Test (d)	A3.3.5.3.4	X
Non-Operating Environmental Tests	A3.2.4	
Storage Temperature	A3.2.4.1	X
Transportation Shock	A3.2.4.2	X
Bench Handling	A3.2.4.3	X
Transportation Vibration	A3.2.4.4	X
Fungus Resistance	A3.2.4.5	X
Salt Fog	A3.2.4.6	X
Fine Sand	A3.2.4.7	X
Operating Environment Tests	A3.2.5	
Thermal Cycling	A3.2.5.7	X
Humidity	A3.2.5.6	X
Thermal Vacuum	A3.2.5.8	X
Temperature Shock	A3.2.5.10	X
Acceleration	A3.2.5.5	X
Shock	A3.2.5.4	X
Sinusoidal Vibration	A3.2.5.1	X
Acoustic Noise	A3.2.5.3	X
Random Vibration	A3.2.5.2	X
EMI/EMC	A3.2.5.9	X
Leakage (g)	A3.2.1.5	X

Continued on next page

Table 3-4E Continued

- (a) These tests are a candidate list; selection of tests for an individual program will depend on specific design and operations considerations. The listed test regime includes the maximum use of functional testing before and after environments; programs may choose to limit or defer these test until the completion of all environment tests. Use of the full regime provides the best opportunity to pinpoint the cause of failures that may occur during environments.
- (b) These QTP samples are tested at the individual part level and not integrated into the IMU.
- (c) These tests shall be performed before and after environments. Compare results to determine if there is any degradation in performance.
- (d) This is a one-time test at the completion of all environments.
- (e) These tests shall be performed during environment test.
- (f) These tests should be performed during each Operating Environment Test.
- (g) This test shall be performed after the last non-operating and last operating environment tests.

TABLE A3-3F. INTEGRATED/COUPLED GPS/IMU COMPONENT REQUIREMENTS ACCEPTANCE TEST (a)		
TEST	TEST REQUIREMENT	QUANTITY TESTED
Product Examination	3.2.1	
Visual	A3.2.1.1	100%
Dimension	A3.2.1.2	100%
Identification	A3.2.1.3	100%
Instrument Level Acceptance Tests	Table A3-3g-1 Table A3-3g-2	100% 100%
GPS Functional Tests (b)	Table A3-3b	100%
IMU Functional Tests (c)	Table A3-3e	100%
Combined GPS/IMU Functional Tests (d)	A3.3.5.4	
Continuity & Isolation	A3.3.5.4.1	100%
Combined GPS/IMU Navigation Functional Test	A3.3.5.4.3	100%
Reference Functional Test (e) (f) (g)	A3.1.11	
Input Current	A3.3.5.4.2	100%
Monitor GPS, IMU, and Blended Solutions (h)	A3.3.5.4.5	100%
Monitor GPS Pseudo-Range and Rate (h)	A3.3.5.4.6	100%
Operating Environment Tests (j)	A3.2.5	
Thermal Cycling	A3.2.5.7	100%
Thermal Vacuum	A3.2.5.8	100%
Random Vibration	A3.2.5.2	100%
Acceleration	A3.2.5.5	100%
Acoustic Noise	A3.2.5.3	100%
Leakage (i)	A3.2.1.5	100%
<p>(a) These tests are a candidate list; selection of tests for an individual program will depend on specific design and operations considerations. The listed test regime includes the maximum use of functional testing before and after environments; programs may choose to limit or defer these tests until the completion of all environment tests. Use of the full regime provides the best opportunity to pinpoint the cause of failures that may occur during environments.</p> <p>(b) Perform referenced GPS functional tests with the IMU disabled.</p> <p>(c) Perform referenced IMU functional tests with the IMU disabled.</p> <p>(d) These tests shall be performed before and after each environmental test.</p> <p>(e) These tests shall be performed during the operating environment tests.</p> <p>(f) Perform dynamic simulation, TEST 2, paragraph A3.1.7 during the hot and cold thermal dwells of the first and last thermal cycle. TEST 3 of paragraph A3.1.7 should be used during the thermal ramps.</p> <p>(g) Perform dynamic simulation, TEST 3, paragraph A3.1.7.</p> <p>(h) GPS input may include satellite simulator, use of “live” satellites from roof-mounted antenna, etc. depending on program needs.</p> <p>(i) This test shall be performed after the last operating environment test.</p> <p>(j) At the completion of all Operating Environment Tests perform Confirmation Testing in accordance with paragraph A3.3.5.4.6.</p>		

TABLE A3-4F. INTEGRATED/COUPLED GPS/IMU COMPONENT REQUIREMENTS QUALIFICATION TEST (a)		
TEST	TEST REQUIREMENT	QUANTITY TESTED 1
Acceptance Testing	Table A3-3f	X
GPS Functional Tests (b)	Table A3-4a	
IMU Tests (c)	Table A3-4e	X
Combined GPS/IMU Functional Tests (d)	A3.3.5.4	
Continuity & Isolation	A3.3.5.4.1	X
Combined GPS/IMU Navigation Test, blended	A3.3.5.4.3	X
Reference Functional Test (e), (f) (g)	A3.1.11	
Input Current	A3.3.5.4.2	X
Monitor GPS, IMU, and Blended Solutions	A3.3.5.4.5	X
Monitor GPS Pseudo-Range and Rate (h)	A3.3.5.4.6	X
Other Functional Tests		
Sensor Performance Test (i)	A3.3.5.4.4	X
Non-Operating Environmental Tests	A3.2.4	
Storage Temperature	A3.2.4.1	X
Transportation Shock	A3.2.4.2	X
Bench Handling	A3.2.4.3	X
Transportation Vibration	A3.2.4.4	X
Fungus Resistance	A3.2.4.5	X
Salt Fog	A3.2.4.6	X
Fine Sand	A3.2.4.7	X
Operating Environment tests	3.2.5	
Thermal Cycling	A3.2.5.7	X
Humidity\	A3.2.5.6	X
Temperature Shock	A3.2.5.10	X
Thermal Vacuum	A3.2.5.8	X
Acceleration	A3.2.5.5	X
Shock	A3.2.5.4	X
Sinusoidal Vibration	A3.2.5.1	X
Acoustic Noise	A3.2.5.3	X
Random Vibration	A3.2.5.2	X
EMI/EMC	A3.2.5.9	X
Coupled Solution Confirmation Test	A3.3.5.4.4.1	X
Leakage (i)	A3.2.1.5	X

Continued on next page

Table A3-4f Continued

- (a) These tests are a candidate list; selection of tests for an individual program will depend on specific design and operations considerations. The listed test regime includes the maximum use of functional testing before and after environments; programs may choose to limit or defer these tests until the completion of all environment tests. Use of the full regime provides the best opportunity to pinpoint the cause of failures that may occur during environments.
- (b) Perform referenced GPS functional tests with the IMU disabled.
- (c) Perform referenced IMU functional tests with the GPS disabled.
- (d) These tests shall be performed before and after each environmental test.
- (e) These tests shall be performed during the operating environment tests.
- (f) Perform dynamic simulation, TEST 2, paragraph A3.1.7 during the hot and cold thermal dwells of the first and last thermal cycle. TEST 3 of paragraph A3.1.7 should be used during the thermal ramps.
- (g) Perform dynamic simulation, TEST 3, paragraph A3.1.7.
- (h) GPS input may include satellite simulator, use of “live” satellites from roof-mounted antenna, etc. depending on program needs.
- (i) This test shall be performed after the last operating environment test.

**TABLE A3-3G-1. ACCELEROMETER TEST REQUIREMENTS
ACCEPTANCE TEST (A)**

TEST	TEST REQUIREMENT	QUANTITY TESTED
Product Examination Visual Dimension Identification	3.2.1 A3.2.1.1 A3.2.1.2 A3.2.1.3	100% 100% 100%
Functional Test - Unit Operating (b) Continuity and Isolation Scale Factor and Bias (d) Short Term Stability (d) Input Axis Misalignment (d) Static Multipoint (d) Input Range (e) Threshold (c)	A3.1.6 A3.3.5.1.1 A3.3.5.1.4 A3.3.5.1.5 A3.3.5.1.8 A3.3.5.1.9 A3.3.5.1.10 A3.3.5.1.13	100% 100% 100% 100% 100% 100% 100%
Reference Functional Tests (f) Input Current (g) Warm-up Time (h) Sensitivity (i) Repeatability (h) Monitor Indicated Acceleration (k)	A3.1.11 A3.3.5.1.2 A3.3.5.1.3 A3.3.5.1.7 A3.3.5.1.6 A3.3.5.1.15	100% 100% 100% 100% 100%
Other Tests Long Term Stability (l) Precision Centrifuge (j)	A3.3.5.1.5 A3.3.5.1.11	100% 100%
Operating Environment Tests Thermal Cycling Thermal Vacuum Random Vibration Acceleration Acoustic Noise	A3.2.6 A3.2.6.4 A3.2.6.5 A3.2.6.1 A3.2.6.3 A3.2.6.2	100% 100% 100% 100% 100%
Leakage (c)	A3.3.5.1.14	100%
<p>(a) These tests are performed at the individual sensor subassembly level. These tests are a candidate list; selection of tests for an individual program will depend on specific design and operations considerations. The listed test regime includes the maximum use of functional testing before and after environments; programs may choose to limit or defer these tests until the completion of all environment tests. Use of the full regime provides the best opportunity to pinpoint the cause of failures that may occur during environments.</p> <p>(b) These tests shall be performed before and after environments. Compare results to determine if there is any degradation in performance.</p> <p>(c) These functional tests should be performed before and after Random Vibration and Acoustic Noise.</p> <p style="text-align: center;">Continued on next page</p>		

Table A3-3G-1 Continued

- (d) These functional tests should be performed before and after Thermal Cycling, Random Vibration, Thermal Vacuum, Acceleration, and Acoustic Noise.
- (e) These functional tests should be performed before and after Acceleration.
- (f) These tests shall be performed during environment.
- (g) These Reference Functional Tests should be performed during all Operating Environment Tests.
- (h) These Reference Functional Tests should be performed during Thermal Cycling.
- (i) Depending on design, implementation, and operating conditions measure changes in accelerometer scale factor and bias (sensitivity) due to variations in selected parameters. Candidate parameters include input voltage, input power frequency, temperature, and or pressure.
- (j) These Reference Functional Tests should be performed during Acceleration.
- (k) Monitor during Thermal Cycling, Random Vibration, Thermal Vacuum, and Acoustic Noise.
- (l) Depending on the tests chosen for a particular program, use test results to obtain best fit linear curves to the bias and scale factor. Typically calculated using least squares, compare rms deviation of data points from best fit lines compare to specified values.

**TABLE A3-4G-1. ACCELEROMETER TEST REQUIREMENTS
QUALIFICATION TEST (A)**

TEST	TEST REQUIREMENT	QUANTITY TESTED 1
Accelerometer Acceptance Tests	Table A3-3g-1	X
Functional Test (b) Continuity and Isolation Scale Factor and Bias (d) Short Term Stability (e) Input Axis Misalignment (f) Static Multipoint (g) Threshold (c)	A3.1.6 A3.3.5.1.1 A3.3.5.1.4 A3.3.5.1.5 A3.3.5.1.8 A3.3.5.1.9 A3.3.5.1.13	X X X X X X X
Reference Functional Tests (h) Input Current (i) Warm-up Time (j) Sensitivity (k) Repeatability (j) Input Range (l) Monitor Acceleration (m)	A3.1.11 A3.3.5.1.2 A3.3.5.1.3 A3.3.5.1.7 A3.3.5.1.6 A3.3.5.1.10 A3.3.5.1.15	X X X X X X X
Other Tests Long Term Stability (n) Precision Centrifuge (l)	A3.3.5.1.5 A3.3.5.1.11	X X
Non-Operating Environmental Tests Storage Temperature Transportation Shock Bench Handling Transportation Vibration Fungus Resistance Salt Fog Fine Sand	A3.2.4 A3.2.4.1 A3.2.4.2 A3.2.4.3 A3.2.4.4 A3.2.4.5 A3.2.4.6 A3.2.4.7	X X X X X X X X
Leakage (c)	A3.3.5.1.14	X

- (a) These tests are performed at the individual sensor subassembly level. These tests are a candidate list; selection of tests for an individual program will depend on specific design and operations considerations. The listed test regime includes the maximum use of functional testing before and after environments; programs may choose to limit or defer these test until the completion of all environment tests. Use of the full regime provides the best opportunity to pinpoint the cause of failures that may occur during environment.
- (b) These tests shall be performed before and after environments with unit operating during the test. Compare results to determine if there is any degradation in performance.
- (c) These functional tests should be performed before and after Random Vibration, Shock, and Acoustic Noise.
- (d) These functional tests should be performed before and after Thermal Cycling, Thermal Vacuum, Acceleration, Shock, Sine Vibration, Acoustic Noise, Random Vibration, and EMI/EMC.
- (e) These functional tests should be performed before and after Thermal Cycling, Thermal Vacuum, Thermal Shock, Random Vibration, Shock, Sine, Vibration, Acceleration, and Acoustic Noise.

Continued on next page

Table A3-4G-1 Continued

- (f) These functional tests should be performed before and after Thermal Cycling, Thermal Vacuum, Acceleration, Shock, Sine Vibration, Acoustic Noise, Random Vibration, EMI/EMC, and Thermal Shock.
- (g) These functional tests should be performed before and after Thermal Cycling, Thermal Shock, Random Vibration, Shock, Thermal Vacuum, Acceleration, and Acoustic Noise.
- (h) These tests shall be performed during environment tests.
- (i) These Reference Functional Tests should be performed during all Operating Environment Tests.
- (j) These Reference Functional Tests should be performed during Thermal Cycling.
- (k) Depending on design, implementation, and operating conditions measure accelerometer scale factor and bias (sensitivity) due to variations in selected parameters. Candidate parameters include input voltage, input power frequency, temperature, and or pressure.
- (l) These Reference Functional Tests should be performed during Acceleration.
- (m) Monitor during Thermal Cycling, Thermal Vacuum, Shock, Sine Vibration, Acoustic Noise, Random Vibration, EMI/EMC, and Thermal Shock.
- (n) Depending on the tests chosen for a particular program, use test results to obtain best fit linear curves to the bias and scale factor. Typically calculated using least squares, compare rms deviation of data points from best fit lines, compare to specified values.

TABLE A3-3G-2. RING LASER/FIBER OPTIC GYRO TEST REQUIREMENTS ACCEPTANCE TEST (a)		
TEST	TEST REQUIREMENT	QUANTITY TESTED
Product Examination	3.2.1	
Visual	A3.2.1.2	100%
Dimension	A3.2.1.2	100%
Identification	A3.2.1.3	100%
Functional Test (b)	A3.1.6	100%
Turn-on Time (d)	A3.3.5.2.4	100%
Continuity & Isolation	A3.3.5.2.1	100%
Warm-up Time (d)	A3.3.5.2.5	100%
Scale Factor (e)	A3.3.5.2.8	100%
Input Rate Limits (e)	A3.3.5.2.9	100%
Drift Rate (e)	A3.3.5.2.11	100%
IA Misalignment (e)	A3.3.5.2.12	100%
Reference Functional Tests (f)	A3.1.11	
Input Current (g)	A3.3.5.2.2	100%
Temperature Sensor Characteristics (h) (i)	A3.3.5.2.6	100%
Operating Temperature (h), (i)	A3.3.5.2.7	100%
Scale Factor (h)	A3.3.5.2.8	100%
Drift Rate (h)	A3.3.5.2.11	100%
Monitor Indicated Rate (j)	A3.3.5.2.15	100%
Operating Environment Tests	A3.2.5	
Thermal Cycling	A3.2.5.7	100%
Thermal Vacuum	A3.2.5.8	100%
Random Vibration	A3.2.5.2	100%
Acceleration	A3.2.5.5	100%
Acoustic Noise	A3.2.5.3	100%
Leakage (c)	A3.3.5.2.3	100%
<p>(a) These tests are performed at the individual sensor subassembly level. These tests are a candidate list; selection of tests for an individual program will depend on specific design and operations considerations. The listed test regime includes the maximum use of functional testing before and after environments; programs may choose to limit or defer these test until the completion of all environment tests. Use of the full regime provides the best opportunity to pinpoint the cause of failures that may occur during environments.</p> <p>(b) These tests shall be performed before and after environments. Compare results to determine if there is any degradation in performance.</p> <p>(c) These functional tests should be performed before and after Random Vibration, and Acoustic Noise.</p> <p>(d) These functional tests should be performed before and after Thermal Cycling and Thermal Vacuum.</p> <p>(e) These functional tests should be performed before and after Thermal Cycling, Thermal Vacuum, Random Vibration, Acceleration, and Acoustic Noise.</p> <p>(f) These tests shall be performed during environment test.</p> <p>(g) These Reference Functional Tests should be performed during all Operating Environment Tests.</p> <p>(h) These Reference Functional Tests should be performed during Thermal Cycling.</p> <p>(i) For units with external terminals for temperature sensor readout.</p> <p>(j) Monitor during Thermal Cycling, Thermal Vacuum, Random Vibration, and Acoustic Noise.</p>		

TABLE A3-4G-2. RING LASER/FIBER OPTIC GYRO TEST REQUIREMENTS QUALIFICATION TEST (a)		
TEST	TEST REQUIREMENT	QUANTITY TESTED 1
Gyro Acceptance Tests	Table A3-3g-2	X
Functional Test (b)	A3.1.6	
Continuity & Isolation	A3.3.5.2.1	X
Turn-on Time (d)	A3.3.5.2.4	X
Warm-up Time (d)	A3.3.5.2.5	X
Scale Factor (e)	A3.3.5.2.8	X
Input Rate Limits (e)	A3.3.5.2.9	X
Drift Rate (e)	A3.3.5.2.11	X
Input Alignment Misalignment (e)	A3.3.5.2.12	X
Reference Functional Tests (f)	A3.1.11	
Input Current (g)	A3.3.5.2.2	X
Temperature Sensor Characteristics(h) (i)	A3.3.5.2.6	X
Operating Temperature (h) (i)	A3.3.5.2.7	X
Scale Factor (h)	A3.3.5.2.8	X
Drift Rate (h)	A3.3.5.2.11	X
Monitor Indicated Rate (j)	A3.3.5.2.15	X
Non-Operating Environmental Tests	A3.2.4	
Storage Temperature	A3.2.4.1	X
Transportation Shock	A3.2.4.2	X
Bench Handling	A3.2.4.3	X
Transportation Vibration	A3.2.4.4	X
Fungus Resistance	A3.2.4.5	X
Salt Fog	A3.2.4.6	X
Fine Sand	A3.2.4.7	X
Operating Environment Tests	A3.2.5	
Thermal Cycling	A3.2.5.7	X
Humidity	A3.2.5.6	X
Thermal Vacuum	A3.2.5.8	X
Acceleration	A3.2.5.5	X
Shock	A3.2.5.4	X
Sinusoidal Vibration	A3.2.5.1	X
Acoustic (Noise)	A3.2.5.3	X
Random Vibration	A3.2.5.2	X
EMI/EMC	A3.2.5.9	X
Thermal Shock	A3.2.5.10	X
Leakage (c)	A3.3.5.2.3	X
Continued on next page		

Table A3-4G2 Coninued

- (a) These tests are performed at the individual sensor subassembly level. These tests are a candidate list; selection of tests for an individual program will depend on specific design and operations considerations. The listed test regime includes the maximum use of functional testing before and after environments; programs may choose to limit or defer these test until the completion of all environment tests. Use of the full regime provides the best opportunity to pinpoint the cause of failures that may occur during environments.
- (b) These tests shall be performed before and after environments. Compare results to determine if there is any degradation in performance.
- (c) These functional tests should be performed before and after Random Vibration, and Acoustic Noise.
- (d) These functional tests should be performed before and after Thermal Cycling and Thermal Vacuum.
- (e) These functional tests should be performed before and after Thermal Cycling, Thermal Vacuum, Acceleration, Shock, Sine Vibration, Acoustic Noise, Random Vibration, EMI/EMC, and Thermal Shock.
- (f) These tests shall be performed during environment test.
- (g) These reference functional tests should be performed during all Operating Environment Tests.
- (h) These reference functional tests should be performed during Thermal Cycling.
- (i) For units with external terminals for temperature sensor readout.
- (j) Monitor during Thermal Cycling, Thermal Vacuum, Acceleration, Shock, Sine Vibration, Acoustic Noise, Random Vibration, EMI/EMC, and Thermal Shock.

A3.3.5 Inertial Measurement Test Requirements

A3.3.5.1 Accelerometer Test Requirements

A3.3.5.1.1 Continuity and Isolation (R)

a. Measure the component continuity and isolation resistance between the case ground and power all power leads, and signal outputs, including returns, and between power leads and signal leads, including returns are within requirements that are specified in the component specification. Resistance values should be within specification.

b. Resistance values should be within specification.

A3.3.5.1.2 Input Current (R)

a. Measure current at low, nominal, and high supply voltages. During dynamic environmental testing input current should be continuously monitored at 1 ms resolution.

b. Input current values shall remain within specification throughout testing.

A3.3.5.1.3 Accelerometer Warm-Up Time

Measure time required (from turn-on) for accelerometer output to reach specified limits. This test is performed in an ambient environment.

A3.3.5.1.4 Accelerometer Scale Factor and Bias

Mount the accelerometer in a mounting head, record output in the 90 and 270-degree positions. Calculate scale factor and bias using equations found in [Reference 1](#).

A3.3.5.1.5 Accelerometer Short and Long Term Stability

Determine the rms deviation of accelerometer scale factor and bias from their mean values over a short and long term measurement period.

A3.3.5.1.6 Accelerometer Repeatability

Measure turn-on to turn-on repeatability of accelerometer scale factor and bias allowing for a cool-down period after each measurement to permit the unit to reach thermal equilibrium. Other environments may be used instead of or added to temperature, including vibration and shock.

A3.3.5.1.7 Accelerometer Sensitivity

This test determines changes in accelerometer scale factor and bias due to variations in input voltage, power input frequency, temperature, external magnetic fields, and/or pressure. Vary each parameter individually while all other test conditions are held constant.

A3.3.5.1.8 Accelerometer Input Axis Misalignment

This test determines the misalignment of the input axis with respect to external references such as mounting marks or keys (input reference axis). Place the accelerometer on a dividing head at 0 degree record output. Rotate the accelerometer to the 180-degree position. Calculate the misalignment angle using equations from [Reference 1](#).

A3.3.5.1.9 Accelerometer Static Multipoint Test (sometimes called a “Plus and Minus One G Test”)

This test determines input/output linearity over a 1g-test range. Mount the accelerometer on a dividing head using 0, 180, and 360-degree stops. Measure instrument input and output at each stop. Use formulas found in [Reference 1](#) to plot the accelerometer input/output function.

A3.3.5.1.10 Accelerometer Input Range Test (Centrifuge)

This test verifies that the input acceleration range meets the specified range. The accelerometer is used to impose acceleration across the full range of specified input in the

positive and negative axis. Record accelerometer outputs and verify proper operation throughout the entire range of acceleration. This test is typically not required for units with input ranges of less than 2 g's.

A3.3.5.1.11 Accelerometer Precision Centrifuge Test

This test determines the magnitude of acceleration-sensitive coefficients. This test is also used to determine cross-coupling terms. This test adds a higher level of precision to the Input Range Test (A3.3.5.1.10). For example, arc second precision is employed for axis of rotation verticality and radius from the centrifuge axis to the effective center of mass. Input accelerations are compared to measured accelerations to determine acceleration-sensitive coefficients.

A3.3.5.1.12 Accelerometer Turn-on Hysteresis

This test determines displacement hysteresis resulting from power turn-on. Mount the accelerometer to a dividing head and perform a series of rotations with the initial orientation at 0 degree power on and rotate to 90 degree remove and restore power to the accelerometer, rotate to 0 degree measure and record unit output, rotate to 270 degree, move and restore power, rotate to 0 degree, measure and record output. Calculate hysteresis, using equations found in Reference 1.

A3.3.5.1.13 Accelerometer Threshold Test

This test determines the smallest input acceleration at which the unit output is at least 50 percent of the input. Dividing head positions and equations are found in Reference 1.

A3.3.5.1.14 Leakage Test

This test checks for gas leakage through the unit case. Place the accelerometer in a vacuum chamber and use a leakage detector to measure gas leakage.

A3.3.5.1.15 Monitor Indicated Acceleration

This test monitors the acceleration outputs during the listed environment. Interest is to observe the inherent instrument outputs through out the duration of specified environmental test. Monitor for stability and precision.

Reference 1. "IEEE Standard Specification Format Guide and Test Procedure for Linear, Single-Axis digital Torque-Balance Accelerometer"; (ANSI/IEEE Standard 530), published by the Institute of Electrical and electronics Engineers. Inc. 345 East 47th Street, New York, New York, 1-800-854-7179. Note that there will be differences in standards and test procedures for different types of accelerometers. For linear single-axis pendulous analog torque-balance units use IEEE Standard 337.

A3.3.5.2 Single-Axis Laser Gyro Test Requirements

A3.3.5.2.1 Continuity and Isolation (R)

- a. Measure the components continuity and isolation resistance between the case ground and power all power leads, and signal outputs, including returns, and between power leads and signal leads, including returns are within requirements that are specified in the component specification. Resistance values should be within specification.
- b. Resistance values should be within specification.

A3.3.5.2.2 Input Current (R)

- a. Measure current at low, nominal, and high supply voltages. During dynamic environmental testing input current shall be continuously monitored at 1 ms resolution.
- b. Input current values shall remain within specification throughout testing.

A3.3.5.2.3 Leakage Test

This test checks for gas leakage through the unit case. Place the gyro in a vacuum chamber and use a leakage detector to measure gas leakage.

A3.3.5.2.4 Turn-on time test

This test measures the time from application of power the first moment that the gyro outputs a useable signal.

A3.3.5.2.5 Warm-up Time Test

This test determines the time from power-on to the moment that the unit reaches specification-level performance.

A3.3.5.2.6 Temperature Sensor Characteristics (for gyros that provide external terminals for temperature sensor readout)

This test determines temperature variation and output magnitude of the sensor. Mount the gyro in a temperature-controlled chamber, stabilize, and measure sensor output across the range of operating temperatures.

A3.3.5.2.7 Operating Temperature Test (for gyros that provide external terminals for temperature sensor readout)

This test verifies that the temperature sensor accurately measures actual temperature of the operating unit. Place the gyro in a temperature-controlled chamber, permit the unit to reach thermal equilibrium, measure and record output, confirm that accuracy is within specified limits.

A3.3.5.2.8 Gyro Scale Factor Tests

- a. Gyro Scale Factor. Mount the gyro on a rate table with angular readout. Perform a zero table-rate measurement with the input axis parallel to the rotational axis. Measure output pulse across the input rate range. This test can also be used to determine bias and random drift characteristics. Note that gyros with anti-lock protection will use slightly different procedures for the rate table per Reference 2.
- b. Gyro Scale Factor Sensitivity (temperature). Repeat Test A. above at specified temperatures using specified dwell times. It is not necessary to perform this test across the full range of input range.
- c. Gyro Scale Factor Sensitivity Gradient. Measure temperature gradient across the major axes.
- d. Gyro Scale Factor Calculations. Using test results from a. through c. above, compute the scale factor, and asymmetry, nonlinearity, repeatability, stability, and sensitivities for temperature and temperature gradient using equations from Reference 2.

A3.3.5.2.9 Input Rate Test Series

This group of tests confirms that scale factor linearity requirements are met under the full range of specified rates. Set up and operate using the same parameters as the Gyro Scale Factor Series. Use test data to calculate linearity at maximum input rate, and minimum input rate.

A3.3.5.2.10 Anti-lock and Quantization Noise Test

This test determines quantization noise associated with anti-lock protection (if applicable) and quantization. This test requires a compensation device (special test equipment). Mount the gyro with the axes in reference positions and measure time-correlated outputs. Use equations in Reference 2 to calculate anti-lock residual and quantization noise.

A3.3.5.2.11 Drift Rate Test

This test determines the coefficients, repeatabilities, and sensitivities, of random drift associated with gyro random drift as well as environmentally sensitive terms. For gyros with anti-lock protection the unit should be mounted for precise positioning with axes in reference positions; the anti-lock compensation device is used for this test. For gyros without anti-lock the test procedures is the same as the Gyro Scale Factor Test. Measure and record outputs using a sample rate at least twice the highest frequency of interest. Test duration should be keyed to required confidence. Use data reduction techniques found in Reference 2.

- a. Repeatability. Repeat the procedure the number of times listed in the specification.
- b. Temperature Sensitive Drift. Stabilize the unit at specified high and low temperatures, measure and record outputs.
- c. Temperature Gradient. Measure temperature gradients across the unit case at specified high and low temperatures.
- d. Magnetic. Use field generating equipment to impose steady-state flux densities per the specification as directed along the input and other specified axes.

A3.3.5.2.12 Input Alignment Characteristics

This test determines misalignment between the Input Axis and the Input Reference Axis (see paragraph A3.3.5.2.8). Mount the gyro on a rate table, axis orientation and rates described in Reference Two. Use equations from Reference 2 to calculate and repeatability.

A3.3.5.2.13 Generated Fields

This test measures electromagnetic interference generated by the unit per MIL STDs listed in the specification.

A3.3.5.2.14 Magnetic Leakage Test

This test measures magnetic flux leakage escaping from the gyro.

A3.3.5.2.15 Monitored Indicated Rate

This test monitors the observed rate outputs during the listed environment. Interest is to observe the inherent instrument outputs though out the duration of specified environmental test. Monitor for stability and precision in outputs.

Reference 2. “IEEE Standard Specification Format Guide and Test Procedure for Single-Axis Laser Gyros”; (IEEE Standard 647), The Institute of Electrical and Electronics Engineers Inc., 345 East 47th Street, New York, New York, 1-800-854-7179. For fiber –optic gyros use IEEE Standard 952. For other types of gyros other standards will apply.

A3.3.5.3 Inertial Measurement Unit (IMU) Test Requirements

A3.3.5.3.1 Continuity and Isolation (R)

- a. Measure the components continuity and isolation resistance between the case ground and power all power leads, and signal outputs, including returns, and between power leads and signal leads, including returns are within requirements that are specified in the component specification. Resistance values should be within specification.
- b. Resistance values should be within specification.

A3.3.5.3.2 DC Input voltage (R) (A) (S) (L)

- a. Verify proper operation at specified voltage range. Typically: 24, 28, 32 VDC.
- b. The unit under test shall perform within specification throughout the specified voltage range.
- c. For qualification, a reverse polarity test should be included.

A3.3.5.3.3 Input Current (R)

- a. Measure current at low, nominal, and high supply voltages. During dynamic environmental testing input current shall be continuously monitored at 1 ms resolution for fluctuations.
- b. Input current values shall remain within specification throughout testing.

A3.3.5.3.4 Navigation Functional Test (NFT)

- a. Verify that the inertial solution meets performance requirements.
- b. The NFT includes a gyrocompass alignment followed by a static navigation performance run. During the performance run the navigation solution should be monitored and all performance parameters should remain within specification. Baro-aiding should be included if appropriate for the system design.
- c. Typical performance parameters include position (Circular Error Probable or CEP), velocity x, velocity y, velocity z, and attitude for the inertial solution. CEP calculations are typically calculated post-test from the Radial Position Error Growth Rate (RPER). A typical reference is to compare azimuth (heading), pitch, and roll to the attitude determined at the end of alignment, before entering the navigation mode.
- d. The NFT is run prior to, during (if applicable), and after each environmental test.

A3.3.5.3.5 Sensor Performance Tests

- a. At the completion of environmental testing a one-time test should be performed to verify that the inertial instruments do not exceed the specified error budget. Typical tests for gyroscopes include bias, random walk, scale factor, and non-orthogonality. Typical accelerometer tests include bias, scale factor, non-linearity, and non-orthogonality. Additionally, the inertial assembly-to-chassis misalignment may be checked. A typical comparison would ensure that the measurements do not violate the two-sigma instrument specified error budget. The sensor performance test includes two major test sections, calibration and navigation bias.
- b. The calibration test employs a test table programmed to rotate through controlled positions (may include as many as 22 positions) at controlled rates with standard dwell times between rotations. The calibration test outputs gyro scale factor, gyro non-orthogonality, accelerometer bias, and accelerometer scale factor, accelerometer non-orthogonality, and accelerometer linearity.

A3.3.5.3.6 Monitor Navigation Solution and Velocity Errors

Monitor designated parameter during listed environment. Interest is to observe inherent instrument outputs though out the duration of specified environmental test. The unit output should be observed at the output rate. For example, an IMU that provides a 10 Hz state vector should be monitored at the 10 Hz rate. Monitor for stability and precision.

A3.3.5.4 Coupled Inertial INS/GPS Test Requirements

A3.3.5.4.1 Continuity and Isolation (R)

- a. Verify that the components continuity and isolation resistance between the case ground and power all power leads, and signal outputs, including returns, and between power leads and signal leads, including returns are within requirements that are specified in the component specification.
- b. Resistance values should be within specification.

A3.3.5.4.2 Input Current (R)

- a. Measure current at low, nominal, and high supply voltages. During dynamic environmental testing input current shall be continuously monitored at 1 ms resolution.
- b. Input current values shall remain within specification throughout testing.

A3.3.5.4.3 Navigation Functional Test (NFT)

- a. Verify that the inertial-only, GPS-only, and blended requirements are met while accepting GPS signals from a satellite simulator or a “live sky” input using inputs from a roof-mounted antenna.
- b. The NFT includes a gyrocompass alignment followed by a static navigation performance run. During the performance run the navigation solutions should be monitored and all performance parameters should remain within specification. Baro-aiding should be included if appropriate for the system design.
- c. Typical performance parameters include position (Circular Error Probable or CEP), velocity x, velocity y, velocity z, and attitude for the inertial-only solution; position, velocity x, velocity y, and velocity z, for the GPS-only, and position, velocity x, velocity y, velocity z, and attitude for the blended solution (if applicable). CEP calculations for the inertial solution are typically calculated post-test from the Radial Position Error Growth Rate (RPER). For the inertial and blended attitude measurements, a typical reference is to compare azimuth (heading), pitch, and roll to the attitude determined at the end of alignment, before entering the navigation mode.
- d. The NFT is run prior to, during (if applicable), and after each environmental test.

A3.3.5.4.4 Sensor Performance Tests

- a. At the completion of environmental testing a one-time test should be performed to verify that the inertial instruments do not exceed the specified error budget. Typical tests for gyroscopes include bias, random walk, scale factor, and non-orthogonality. Typical accelerometer tests include bias, scale factor, non-linearity, and non-orthogonality. Additionally, the inertial assembly-to-chassis misalignment may be checked. A typical comparison would ensure that the measurements do not violate the two-sigma instrument specified error budget. The sensor performance test includes two major test sections, calibration and navigation bias.

- b. The calibration test employs a test table programmed to rotate through controlled positions (may include as many as 22 positions) at controlled rates with standard dwell times between rotations. The calibration test outputs gyro scale factor, gyro non-orthogonality, accelerometer bias, and accelerometer scale factor, accelerometer non-orthogonality, and accelerometer linearity.
- c. The navigation bias includes runs at the three major orientations (for example, north, east, and down). During each run gyro data is collected for all three axes. Test outputs are gyro random walk, total drift (deg/hr), and gyro bias.
- d. The entire sensor performance test should be run at room temperature, as well as high and low specified temperatures.

A3.3.5.4.4.1 Confirmation Testing

These tests confirm that integrate IMU/GPS can meet performance requirements under stressing conditions. These tests address designs that incorporate a blended solution that operates on inertial and GPS outputs. Typically the inertial outputs are used to directly aid GPS tracking. Two key elements of this design drive test requirements. First, the GPS solution is well suited for simulation testing. The GPS receiver and the resulting outputs to the blended solution respond to dynamic simulation inputs from a satellite simulator. Second, the inertial solution is far more limited; the “benched” IMU can only respond to earth roll rate and gravity. In other words, the GPS is far better suited to simulation. It is, however, possible to bypass the inertial input to the blended solution and inject inertial simulation signals directly. In this case the blended solution operates on satellite simulator-driven GPS receiver outputs and simulated inertial inputs. The following candidate test requirements apply to this configuration.

A3.3.5.4.4.1.2 Nominal Trajectory

Use the satellite simulator to inject nominal inputs to the GPS receiver. Inject a simulated nominal trajectory into the inertial inputs to the blended solution. Record the receiver outputs and the filter outputs. This is the baseline response.

A3.3.5.4.4.1.3 Inertial-Only Solution

Disconnect the GPS input to the blended solution; use a test port to inject the reference nominal trajectory into the filter inertial input. Verify that the blended solution meets all performance requirements with the GPS input disconnected.

A3.3.5.4.4.1.4 Full Solution with Non-Nominal Inertial Parameters

Candidate non-nominal parameters include failed thrust axis accelerometer, failed non-thrust axis accelerometer, excessive accelerometer bias, failed gyro, excessive gyro bias, excessive acceleration, and excessive angular rate. The intent of using these parameters is to confirm that the blended solution will operate properly under non-nominal conditions. Use the satellite simulator to inject nominal inputs to the GPS receiver.

A3.3.5.4.5 Monitor GPS, IMU, and Blended Navigation Solutions

Monitor designated parameter during listed environment. Interest is to observe inherent instrument outputs though out the duration of specified environmental test. The unit outputs should be observed at the output rate. For example, an IMU that provides a 10 Hz state vector output should be monitored at the 10 Hz rate. Monitor outputs for stability and precision.

A3.3.5.4.6 Monitor GPS Pseudo-Range and Pseudo-Range Rate

Monitor designated parameter during listed environment. Interest is to observe inherent instrument outputs though out the duration of specified environmental test. Monitor Pseudo-Range and Pseudo-Range rate outputs for stability and precision.

TABLE A3-3H. GPS GROUND TRANSLATOR PROCESSOR ACCEPTANCE TEST		
TEST	TEST REQUIREMENT	QUANTITY TESTED
Functional Test	3.1.6	
Sensitivity	A3.3.6.1	100%
Reacquisition	A3.3.6.3	100%
RAIM	A3.3.6.4	100%
De-selection of Faulty Satellites	A3.3.2.10	100%

TABLE A3-4H. GPS GROUND TRANSLATOR PROCESSOR QUALIFICATION TEST		
TEST	TEST REQUIREMENT	QUANTITY TESTED
		1
Acceptance Testing	Table A3-3h	X
Functional Test (a)	3.1.6	
Dynamic Range	A3.3.6.2	X

A3.3.6.1 Sensitivity

Sensitivity testing shall determine the minimum C/N_0 , at which the GTP performs within specification. This sensitivity value is used as part of the L-band link analysis to determine which satellites in view can be used to generate a solution. This test can be performed using the real-time “live” satellite network with an RF attenuator or use Test 2 of the dynamic simulation described in paragraph A3.1.7 for this test. A typical value for C/N_0 is 34 dB-Hz.

A3.3.6.2 Dynamic Range (R)

- a. Perform GPS tracking and measure the quality of the state vector as a function of input power. The GTP shall be subjected to the worst-case RF input (minimum and maximum

power) from lift-off to the end of range safety responsibility. The following S/N ratios shall be used for the minimum RF level:

- (1) **Analog Translator**: The GTP shall be capable of meeting all performance requirements with a 6 dB minimum S/N margin at the receiving antenna.
- (2) **Digital Translator**:

DGT configuration	Standard	FEC Only	Encryption	Both
Eb/No (dB)	3.6	5.3	9.7	5.3

b. GTP shall perform within specification at all RF inputs levels. Verify that bit error rate does not exceed 5×10^{-2} at minimum input signal using specification S/N.

A3.3.6.3 Reacquisition Test (R)

- a. Determine the reacquisition time in a static environment. Input a GPS constellation through a satellite simulator or a “live” constellation and attenuate the L-band signal to cause the receiver to loose lock on all channels. This test should be performed with a dropout of 30 seconds. Valid tracking solution shall occur 5 seconds after the L-band signal is restored.
- b. Determine the reacquisition time in a flight vehicle environment. Reacquisition tests should be performed using worst-case flight vehicle C/N₀ values (minimum and maximum RF power) at acceleration and velocity environments representative of nominal flight vehicle environments.
- c. These tests should be performed a sufficient number of times to characterize performance variability.
- d. This test determines the amount time it takes to reacquire a tracking solution given a loss of L-band signal. The value measured will be used by Range Safety to determine whether there can be an unacceptable loss of tracking during flight vehicle events (e.g. staging and fairing separation). The reacquisition time shall be within its performance specification.

A3.3.6.4 Receiver Autonomous Integrity Monitoring (R)(A)

- a. The GTP shall be tested to verify the capability to autonomously detect and reject a satellite that is out-of-specification regardless of the space vehicle health status.
- b. This test should be performed on a satellite simulator with one satellite providing out-of-specification data.
- c. The GTP shall perform within specification throughout this test

A3.3.6.5 De-selection of Faulty Satellites (R) (A)

- a. Verify the GTP can deselect a faulty satellite for which a space vehicle health bit has been set.
- b. Setting the space vehicle health bits for one satellite to indicate that the satellite is out shall perform this test. The GPS receiver shall read health bit and deselect the satellite.
- c. The GTP shall perform within specification throughout this test.

A4.1 RTS General Analysis Requirements (R) (Q) (A) (S) (L)

Certain detailed analyses performed to validate range safety critical performance analyses will be required for review and approval as determined during the tailoring process. A summary of the results of required analysis should be placed in the RTSR.

A4.2 RTS Failure Analysis (R) (Q) (A) (S) (L)

Failure analysis shall be performed to ensure that a failure is not lost during the troubleshooting effort. Prior to any intrusive/destructive examination (e.g. breaking test configuration, opening the component, desoldering, unplugging connectors, etc), all critical electrical parameters shall be taken before moving on to the next level of disassembly. Range Safety shall grant approval of failure analysis plan prior to any intrusive/destructive examination.

A4.3 RTS Similarity Analyses (R) (Q) (A) (S) (L)

Qualification by similarity is used to reduce or eliminate testing based on tests or analysis already performed on similar or identical hardware. If qualification by similarity is not appropriate, qualification testing should be performed in accordance with this document. If component or piece part A is to be considered as a candidate for qualification by similarity to a component or piece part B that has already been qualified for use, all of the following conditions shall apply:

A4.3.1 Component (Black Box) Similarity Analysis

- a.* Component A should be a minor variation of Component B. Dissimilarities should require analysis of the impact in terms of weight, mechanical configuration, thermal effects, and dynamic response.
- b.* Components A and B should perform similar functions, with A having equivalent or better capability and variations only in terms of performance such as accuracy, sensitivity, formatting, and input/output characteristics.
- c.* Components A and B should be produced by the same manufacturer in the same location, using identical tools and manufacturing processes.
- d.* The environments encountered by Component B during its qualification or flight history should have been equal to or more severe than the qualification environments intended for Component A.
- e.* Component B should have successfully passed a post-environmental functional test series indicating survival of the qualification stresses.
- f.* Component B should have been a representative flight article.
- g.* Component B should not have been qualified by similarity or analysis.
- h.* In cases where all the criteria in the above paragraphs are not satisfied, qualification based on engineering analysis plus partial testing may be necessary.

A4.3.2 Piece/Parts Similarity Analysis

Any addition, subtraction, or replacement of piece/parts within a RTS component shall be reviewed and approved by Range Safety.

a. Piece part A should have similar electrical and mechanical specifications such as weight, mounting configuration, power rating, switching speed, and leakage rate as piece part B. **Note:** When requested, technical justification showing design qualification by similarity should be available to Range Safety for review and approval of any differences in specification between piece part A and B.

Environments such as shock, thermal, and vibration encountered by piece part B during its qualification or flight history should have been equal to or more severe than the qualification environments intended for piece part A.

b. Piece part B should have successfully passed a post-environmental functional test series indicating survival of qualification stresses.

c. Piece part B should not have been qualified by similarity.

A4.4 RTS Reliability Analysis (R)

A reliability analysis should be performed to demonstrate the reliability goal was used in the concept. Guidance can be obtained from MIL-STD-785 and MIL-HNDBK-217. Detailed design of the components and/or system and should include the following data:

a. A discussion of how the RTS meets the design requirements of two sources of tracking throughout flight

b. A calculation of the RTS system reliability.

c. Identification of RTS reliability model input and apportionment

d. Predicted reliability computations for all RTS subsystems and components

e. A description of the effects of storage, transportation, handling, and maintenance on RTS component reliability.

A4.5 RTS Energy/Power Analysis (R)

An analysis should be performed to demonstrate that adequate RTS energy/power life is available from launch through the end of range safety responsibility. Voltage and current parameters should also be analyzed to ensure that the RTS power source maintains the input electrical specifications of RTS hardware.

A4.6 RTS RF Link Analysis (R)

An RF link analysis shall be performed from the vehicle's L-band receive antenna to the range downlink acquisition antenna to ensure that all range safety required performance parameters can be provided throughout range safety responsibility.

a. Analyses shall be performed on nominal missions.

b. Analyses may be required for anomalous vehicle trajectories.

c. Analyses shall be conducted using measured vehicle antenna patterns and the vehicle's 6 degree-of-freedom trajectory. Ranges may require submission of antenna patterns formatted in accordance with RCC 253, Missile Antenna Pattern Coordinate System and Data Formats.

1. Analyses shall include RF link perturbations such as plume effects, heat shield effects, antenna aspect angles relative to satellites and range support stations, and range support station characteristics.

2. Analysis should include the location and number of L-band antenna lever arms.

3. Analysis should take into account prelaunch antenna pattern masking caused by interfering structures such as launch gantries and geographical terrain.

4. Analysis should determine the gain of the antenna system relative to an isotropic radiator and the phase of the far field radiation relative to the antenna excitation.

5. Antenna pattern data should be measured at a minimum of two-degree increments over the complete radiation sphere at the operational RF downlink and L-Band frequency and polarization.

d. Analysis should show that the downlink emissions do not de-sensitize the L-Band receive antenna or interfere with other vehicle system (i.e. FTS).

e. Analysis should be performed on the anticipated constellation for the intended vehicle operational flight time. This analysis determines if there are sufficient satellites in the proper geometry to support range safety performance requirements. Depending on the application, it may be necessary to limit launch/take-off times to ensure the proper constellation is available throughout range safety responsibility.

A4.7 Re-Use (R) (A)

Reusable RTS flight hardware shall be analyzed to determine the ability to withstand repetitive non-operating and operating environments without degradation in performance. The analysis shall show that design or test data envelops the repetitive environmental usage. This type of analysis can include fatigue equivalence by converting high levels for small durations to low levels for high durations.

A4.8 Prior Flight History

A prior flight history analysis should concentrate on the vehicle configuration and operating environments. Differences can include launch vehicle antenna pattern (due to ground plane or antenna configuration differences)

A4.9 RTS RF Environment Analysis (R)

In addition to flight vehicle and range-peculiar frequency sources, MIL-STD-461/462 provides generic testing guidelines for most flight systems.

A4.10 Breakup Analysis (R) (A)

a. Vehicle breakup analyses should be performed in accordance with the FTS criteria required in RCC 319. There are two methods that address non-nominal vehicle performance:

- (1) Determine non-nominal vehicle performance parameters by evaluating credible failure modes (i.e. tumble induced by hard-over engine nozzle and maximum stable turn). Determine if the RTS can perform within specification during these dynamic events.
- (2) The RTS system is capable of autonomously determining when its state vector is not in specification and alerts a Range Safety operator in real-time.

b. There are two requirements associated with using non-nominal vehicle environmental data.

- (1) The breakup analysis data is compared to RTS test limits to ensure that RTS components would not produce false position (i.e. out-of-specification) data during a vehicle failure. In lieu of using breakup analysis data, RTS components can be subjected to a series of stressing environments, which exceed their specification limits. These tests paragraph (see paragraph A3.1.7-Test 2) would characterize worst-case performance and demonstrate that no false position failure modes exist.
- (2) A second objective is maintaining track during non-nominal vehicle flight. The environmental breakup levels should be compared to the RTS specification and test limits. It can be deduced that the RTS has a high likelihood of functioning during non-nominal vehicle flight if the breakup environments are enveloped by the RTS performance.

A4.11 Dynamic Simulation Analysis (R)(A)

As an example, the analysis should include a summary of data dropouts, dropout intervals, tracking accuracy (i.e. position and velocity errors versus time), and track quality indicator results, etc. Standard reporting format for GPS receivers, system accuracy tests and evaluations can be found in IRIG Standard 261.

A4.12 Independence Analysis (R) (I) (M) (A) (S) (L) (Q)

This analysis shall evaluate all airborne tracking systems and determine any common failure points between them that would affect any range safety performance requirement. This analysis shall include an assessment of any single failures that would result in loss of all tracking data (R), status-of-health (M)(Q), state vector performance (A), sample rate (S), or data latency (L) for multiple tracking systems. This evaluation shall also include GPS tracking system support hardware such as power and TM downlink systems.

A4.13 Failure Modes and Effects Criticality Analysis (FMECA) (R) (I) (M) (A) (S) (L) (Q)

This analysis shall ensure that there are no single failures that result in real-time undetectable single failures that produce out-of-specification tracking data. This analysis shall take into account hardware, software/firmware and combined hardware/software failure modes.

Note: Single failures that result in loss of tracking data for a single RTS component are acceptable; the concern is for real-time undetectable single failures that produce out-of-specification tracking data. To demonstrate compliance to this analysis, the FMECA analysis should be supplemented with test data.

A5.0 Documentation Requirements (Q) (R)

A5.1 RTS Component Test History (R) (Q)

- a. A test history should be maintained for each RTS component.
- b. The test history should be made available to Range Safety upon request.
- c. The test history may include the following information:
 - Component serial number
 - Date of initial manufacture
 - Date of initial acceptance test procedure
 - Date of modification with brief description of the modification
 - Date of any subsequent tests or acceptance test procedures
 - Date of test and/or retest
 - Reason for the retest (failure, exceeded the certification period)
 - For each test, the test procedure should be referenced and the parts of the test attempted should be identified.
 - Any tests performed by the range should be annotated by the range on the test history.
 - Previous flight history

A5.2 Reporting In-Flight Anomalies (R) (Q) (A) (S) (L)

a. Any in-flight anomaly occurring in an RTS component or identical non-RTS component shall be reported to Range Safety immediately. **Note:** Anomalies include exposing an RTS component to an environment exceeding the maximum predicted environment (MPE).

b. A detailed written report containing a description and analysis of the anomaly and planned corrective actions shall be made available to Range Safety before the system will be approved for any subsequent flights.

A5.3 RTS RF Link Analysis (R) (Q)

a. A GPS L-band RF link analysis should be submitted to Range Safety for review and approval.

b. Antenna gain and phase patterns should be provided to the range for each program. The gain of the antenna system relative to an isotropic radiator and the phase of the far field radiation relative to the antenna excitation should be measured at two-degree increments over the complete radiation sphere at the operational RF downlink and L-Band frequency and polarization.

1. One copy of RTS antenna patterns on floppy discs and in graphical representation, developed in accordance with RCC document 253, should be submitted to the range.
2. The submittal schedule is found in RCC 253.

A5.4 RF Downlink Measurement List (M) (Q)

Range users should submit an RF downlink measurements list within 60 days of the required need date. To minimize schedule impacts, timelines for submittal should be agreed upon during the tailoring process with each individual range.

A5.5 RTS Compliance Checklist

The compliance checklist section should include a checklist of all design, test, and data requirements. The following items are included in this document:

- a. Criteria/Requirement
- b. System
- c. Compliance
- d. Noncompliance
- e. Not applicable
- f. Resolution
- g. References for compliance, noncompliance, not applicable. **Note:** The rationale for noncompliance and not applicable should be included.

A5.6 Other Documentation

A5.6(a) Range Tracking System Report (Q)

- (1) Overview. A Range Tracking System Report (RTSRs) should be developed by the range user in accordance with the specifications of this document and should be provided to Range Safety for review and development of mission rules.
 - a. The RTSR is the medium through which approval should be obtained.
 - b. The RTSR is a detailed description of the RTS including power systems, power transfer, antennas, RF couplers, GPS receivers, GPS translators, RF downlink transmitters, RF DOWNLINK encoders/multiplexers and ground support equipment. Schematics, functional diagrams, and operational manuals should have well defined standard Institute of Electrical and Electronics Engineers (IEEE) or MIL-SPEC terminology and symbols.
 - c. Items such as procedures, component operation, specifications, and manuals that cannot be included in the RTSR because of size or configuration can be referenced in the applicable sections and submitted as attachments.
 - d. If required, the final RTSR should be made available to Range Safety for review. Typically no later than four months prior to the first scheduled launch to ensure a timely response.
 - e. Details of the RTSR are contained later in this section.

- (2) RTS General System Description.

The general system description section should be included in the RTSR. The following items are included in this section:

- a.* A brief and general description of the RTS, including a block diagram showing the location of all RTS components on the vehicle and the interfaces with other systems
- b.* A cable diagram of the RTS
- c.* A complete line schematic of the entire RTS, including RF downlink pick-off points and ground (umbilical) interfaces
- d.* Should include the down link system.

(3) RTS Detailed Component and System Descriptions

The detailed system description section should include complete and detailed narrative description of all of the major components of the RTS. The following items are included:

a. Narrative Description.

- 1.* A complete and detailed description of the RTS operation including all possible scenarios and discussion of how RTS components function at the system and piece part level.
- 2.* A complete and detailed description of each RTS component and how it functions, including specifications and schematics, mechanical and piece part specifications, and operating parameters.

b. Detailed Schematics and Drawings.

- 1.* Detailed schematics of the complete RTS showing component values such as resistance, capacitance, and wattage; tolerance; shields; grounds; connectors and pin numbers; and RF downlink pick-off points
- 2.* The schematics should include all vehicle components and elements that interface with or share common use with the RTS.
- 3.* All pin assignments should be accounted for.
- 4.* Drawings showing the location of all RTS system and subsystem components on the vehicle, including the following descriptions:
 - (a)* Descriptions of element sitting, mounting (attach points), and cable routing for physical isolation
 - (b)* Descriptions of electrical connectors and connections and the electrical isolation of the RTS

A5.6(b) RTS Development, Qualification, Acceptance, Reuse, And Other Test Plans, Test Procedures, And Test Reports (R) (Q)

a. The range user should establish procedures for performing all required tests in accordance with detailed test plans approved by Range Safety. The test plan should indicate the test requirements, testing approach for each component, related special test equipment, facility and system interface requirements. Traceability should be provided from the specified

requirements to the test procedures. The test procedures should cover all operations in enough detail so that there is no doubt as to what is to be done. The pass/fail test criteria should be determined prior to the start of every test.

b. Detailed development, qualification, acceptance, reuse, and other RTS test plans and test procedures submittal to Range Safety for review, should be provided at least 45 calendar days prior to the need date to ensure a coordinated response which meets program schedule objectives. A test procedure may not be required if Range Safety determines that the test plan alone adequately addresses the test parameters during each test sequence.

c. Test plans and test procedures should be reviewed by Range Safety prior to testing.

d. Revisions to any part of a test plan or procedure should be coordinated with Range Safety.

e. Each test report should be provided to Range Safety for review.

f. A list of all test plans, test procedures, and test reports can be incorporated as appendixes to the RTSR.

A5.6(c) RTS Installation and Checkout Procedures (R) (Q)

a. Detailed procedures for checkout, calibration, and installation of all components of the RTS and its associated ground checkout equipment, including the launch day countdown procedures, should be developed by the range user and made available to Range Safety for review. To meet program schedule objectives, data should typically be submitted no later than 45 calendar days prior to the need date. **Note:** Previously used procedures may typically be submitted 30 calendar days prior to the need date.

b. Revisions to any part of a procedure should be coordinated with Range Safety for review.

c. A list of all procedures can be incorporated as an appendix to the RTSR.

A5.6(d) RTS Pre-Flight Test Results (R) (Q)

The following test results for each launch should be provided to Range Safety upon request in a timely manner to facilitate a launch ready status:

- Results of the antenna system test, as required by the RTS Antenna Systems Pre-Flight Tests section of this chapter
- Results of the RTS component vendor acceptance tests
- Results of the RTS Pre-Flight Bench Tests
- Results of the RTS Systems/Subsystem Pre-Flight Tests

A5.6(e) Calibration Program (R) (A) (Q) (L) (S)

a. A calibration program for test equipment should be developed and made available to Range Safety for review and included in the RTSR.

b. Data relative to calibration of the RTS ground support systems should be provided to Range Safety upon request.

5.6.1 A5.6(f) RTS Component and System Test Failure Reports (R) (Q) (A) (S) (L)

Systems or components that fail may not be approved for flight until corrective action, acceptable to Range Safety, has been made. Failures occurring during vendor acceptance testing and launch vehicle subsystem/system testing shall be submitted to Range Safety for review and approval.

a. The failure of an RTS component or an identical non-RTS component to meet specifications should be reported verbally to Range Safety typically within 72 hours and in writing, typically within 14 calendar days of the date the failure is noted.

b. This requirement includes failure of tests conducted at the supplier plant, contractor's plant, or at the range.

c. A formal report containing a description of the failure, an analysis of the failure, and planned corrective actions should be made available to Range Safety typically within 30 calendar days of the failure analysis completion regardless of when or where the failure occurred. **Note:** Components whose test data reflect the unit is out-of-family when compared to other units should be considered as out of specifications.

d. The failure of an RTS component or an identical non-RTS component to meet specifications should be reported verbally to Range Safety typically within 72 hours and in writing, typically within 14 calendar days of the date the failure is noted.

e. This requirement includes failure of tests conducted at the supplier plant, contractor's plant, or at the range.

f. A formal report containing a description of the failure, an analysis of the failure, and planned corrective actions shall be made available to Range Safety typically within 30 calendar days of the failure analysis completion regardless of when or where the failure occurred. **Note:** Components whose test data reflect the unit is out-of-family when compared to other units should be considered as out of specifications.

A5.6(g) Reporting Component Failure to Meet System Test Requirements (R) (Q) (A) (S) (L)

a. The failure of an RTS component to meet system test requirements contained in this chapter shall be reported verbally to Range Safety typically within 72 hours of the failure.

b. A written report containing a description and analysis of the failure and planned corrective actions planned shall be submitted to Range Safety before the component is approved for flight.

A5.6(h) Modifications to RTS Components and Systems (R) (Q) (A) (S) (L) (I) (M)

a. Modification or change to an approved RTS, associated equipment, components, component identification, test procedures, performance test limits, basic characteristics, and ratings, including any firmware or software used on flight and ground equipment or any other changes that may affect the performance of the RTS shall not be made without prior Range Safety approval.

b. If modifications are made without the approval of Range Safety, the approval of the entire system and approval to launch may be revoked automatically until the change is approved.

c. Modification proposals, including the same type of data that would be required for the approval of a new system, should be submitted to Range Safety for review typically within 60 calendar days prior to implementation and should be submitted as an amendment to the RTSR.

A5.6(i) RTS Analysis Results

As applicable, a summary of the results of the following analyses (reference Chapter 4 for analysis descriptions) should be included and the analyses should be submitted separately:

- Radiation
- Qualification by Similarity
- Reliability
- Battery
- RF Link
- Antenna
- Antenna Heat Shield Fly-Off
- Breakup
- Dynamic

A5.6(j) RTS Development, Qualification, and Acceptance Test Plans, Procedures, and Reports

The following data should be included:

- a.* A list of test plans, procedures, and reports by title, number, and revision date
- b.* The maximum predicted flight loads for all anticipated environmental forces such as shock, vibration, and thermal for each RTS component, subsystem, and system
- c.* A summary of the analyses or measurements used to derive the maximum predicted environments for each component
- d.* A matrix of the actual qualification and acceptance test levels used for each component, subsystem, and system in each test versus the predicted flight levels for each environment. The test tolerance allowed for each operational qualification test should be included (for example, shock test at 6 dB over MPE with a ± 3 dB test tolerance)
- e.* A clear identification of those components qualified by similarity analysis or a combination of analysis and test
- f.* A summary of each applicable test report. **Note:** The actual test report should be made available as a stand-alone document.

A5.6(k) Software and Firmware Independent Verifications and Validations

A summary of software and firmware independent verification and validation should be included.

A5.6(l) RTS Modifications

The RTS modifications section should include all coordinated final modifications to an RTS, its associated equipment, component identification, test procedures, or any changes affecting the configuration and integrity of the RTS.

A5.6(m) RTS Ground Support and Monitoring Equipment

The ground support and monitoring equipment section should include a complete description of the ground test equipment used to checkout the RTS including contractor peculiar tests. This section should also include specifications and schematics for all test equipment.

- a. RF Ground Support System (including translator ground processing station)
- b. RF Repeater system
- c. Safety console layout, display arrangement, and function of each monitor
- d. Safety console terminations including the following:
 - Schematics of all RTS monitor circuits from the RTS component pick-off points to the console termination
 - Calibration data for all monitor circuit terminations provided to the console
- e. Any other ground support and monitoring equipment as required by Range Safety.

A5.6(n) RTS Installation and Checkout

The installation and checkout section should include the following information:

- a. A list of procedures for checkout, calibration, and installation of all components, systems, and subsystems of the RTS and its associated ground checkout equipment, including launch day count-down
- b. A task summary of each procedure, including:
 - Each separate task
 - The responsible agency
 - The objective of the procedure
 - Initial and final configuration
 - Equipment and support required
 - Description of task
 - Figures, as required
- c. A flowchart indicating expected time sequence and location of each RTS procedure and task

A5.6(o) RTS Unique Configuration

The unique configuration section should include any information relevant to unique program requirements necessary to satisfy the range.

A5.6(p) Changes to the RTSR

The change section should include a summary of all changes to the last edition of the RTSR. All changes should be highlighted using change bars or similar means of identification.

A5.6(q) Triboelectrification (R)

An analysis should be performed to ensure that electrostatic discharge (triggered lightning) generated from atmospheric debris would not degrade RTS performance.

APPENDIX B

FUNDAMENTAL PRINCIPLES FOR PERFORMANCE REQUIREMENTS

B2.1 RTS General Performance Requirements (R) (I) (A) (S) (L) (O) (M)

Range Safety generates mission rules based on the proposed RTS baseline. Changes to a baseline hardware and software can lead to inaccurate mission rules that could affect life and property. The following items address concerns associated with configuration control:

- a. Changes shall be evaluated to determine if they impact mission rules. If a design is not under configuration control, then Range Safety may be required to implement mission rules that could lead to the termination of a nominal flight.
- b. The ability of the RTS to perform on a non-nominal vehicle could create a safety concern when the vehicle is permitted to continue flight on one source of tracking. The safety risk involves the probability of the remaining one source producing false position data. Under these conditions, the RSO would be unaware of non-nominal vehicle performance and, any inaction, could result in violation of public safety risk criteria. Of particular concern would be guidance failures that result in non-nominal vehicle performance, causing the GPS to become unusable while at the same time the guidance is reporting a nominal trajectory.
- c. Unplanned or non-nominal vehicle RTS performance should be evaluated to ensure that the RTS on an errant launch vehicle provides the required performance up to the point the vehicle breaks up, at which point the FTS should be activated. Failing to define RTS performance during non-nominal vehicle flight could result in a errant vehicle reporting false position data. Under this condition, an RSO might not have the required RTS data necessary to terminate a vehicle that has violated boundaries to protect the public.
- d. (4) Configuration control may be difficult under a Commercial-Off-The-Shelf (COTS) philosophy. For COTS systems, it may be necessary to develop new criteria to address concerns associated with performance variation due to design changes. For configuration controlled RTS components, proposed changes to software and hardware should be discussed with Range Safety to determine possible impacts. Depending on the significance of the software change, a requalification test series may be needed to recharacterize RTS performance. Paragraphs A2.1 (b)(c)(d) allow alternative methods to the standard configuration control model.

B2.1.1 RTS Software and Firmware (R) (A) (S) (L) (Q)

Software and firmware is proven during qualification testing. Any changes can result in unexpected results that could affect required performance parameters. Standard flight hardware philosophy certifies performance based on a series of qualification test unit(s). Production flight hardware is assumed to be a representative sample of the original qualification test unit(s) and is, therefore, expected to perform identically. Based on this philosophy, RTS component acceptance tests are less stringent. Changes to this model may require adding more detailed performance verification tests to all production components.

B2.1.2 RTS Software and Component Failure Modes (A) (S) (L)

a. A primary concern is driven by failure modes (i.e. failure of a tracking source) that could result in only one remaining RTS source of tracking. Without any confidence data, the ability to continue flight on only one RTS source may be jeopardized. Failing to define an RTS performance during non-nominal vehicle flight could result in an errant vehicle reporting false position data. Under this condition, an RSO might not have the required RTS data necessary to terminate a vehicle that has violated boundaries to protect the public. By knowing the failure modes and probabilities ahead of time, then mission rules can be established to protect mission reliability. If failure modes exist that can produce false position data without a data flag notification, mission rules must be developed that account for the vehicle hazards (e.g. size, propellant, launch trajectory, etc) and probability of the RTS failure mode while meeting maintaining public safety. Under these conditions, the RSO could allow a flight to continue flight on one tracking source based on the understanding of the hazards associated with that RTS source. Conversely, mission rules could be developed to terminate a mission if only one source of tracking is available with single point failures or high probabilities for producing false state vector data; in this case, these failures would become a mission assurance concern. In addition, this requirement can be relaxed or even eliminated if additional sources of tracking are available. If a single source of the RTS produced false position data, then the RSO could allow the flight to continue based on the performance and agreement of the other multiple tracking sources.

b. N/C

c. If all tracking sources can be lost with a single point failure, it is primarily a mission assurance concern; in that, a failure would result in termination of a potentially nominal mission. For loss of all tracking, mission rules are currently in place to assume an untrackable vehicle has taken a worst-case turn and is heading towards a destruct line. The time it takes to reach the destruct line is calculated and tracking must be reestablished by this time or the vehicle will be terminated. This philosophy assumes that the vehicle will continue to fly stable, though not nominally. For this scenario, safety may be concerned where the vehicle is performing erratically which could disable the FTS. Thus, allowing continued flight after all tracking is lost adds some risk to the public, which is assessed by the RSO in real-time. If the single point failures associated with the loss of RTS tracking also result in the loss of vehicle control, then it is highly suggested that mission rules be altered to terminate a mission in a short time (e.g. 5 seconds). This is necessary since a loss of all tracking, most likely, also indicates the vehicle is flying erratically and could disable the FTS if allowed to continue for too long.

d. In general, it can be difficult to determine common-cause hardware and software failure modes associated with using identical tracking systems as the only sources of tracking. By providing different tracking derivation methodology (phenomenology), the concerns associated with common hardware and software are minimized. Providing multiple tracking sources using the same phenomenology but from different vendors also minimizes the probability of having common failures as long as each vendor utilizes a different hardware and software design.

B2.1.3 Sample Rate (S)

General. The sample rate is one of the parameters used to determine the accuracy of the vehicle position. The sample rate affects how quickly the RSO is able to recognize a launch vehicle failure and detect a violation of destruct criteria. Range Safety generates destruct criteria to contain hazards in a controlled area and ensure public risk criteria is not violated. Lower sample rates result in uncertainty in vehicle position. This uncertainty is factored into the destruct criteria and, therefore, can make them more conservative. When two sources of tracking are used, the slower of the two sources will be used to generate destruct line criteria. The specified sample rate is understood to indicate that each sample is derived from a different measurement set and not a repeat of a previous value. Low sample rate RTS sources (e.g. greater than 2 sps) should provide their state vector solutions simultaneously with other RTS sources to allow the RSO to more easily compare and validate the integrity of the solutions. Low sample rate tracking systems may still be usable for vehicles on benign launch azimuths or slow moving vehicles may not require high sample rates. For these configurations, tightening of destruct criteria may not affect mission performance. Vehicles equipped with low sample rate RTS sources may have the following launch operation's impacts:

- (1) The range user may have to hold or scrub until launch condition, such as winds or population levels, result in acceptable criteria.
- (2) The vehicle trajectory may have to be changed to account for the increased uncertainty; thus, potentially impacting mission capability.
- (3) More conservative destruct criteria may not allow a non-nominal vehicle to correct itself and make a useful mission.

B2.1.4 RTS Reliability (R)

General:

- (1) For hardware that flies once then is expended, experience has shown that it is difficult to generate an accurate reliability number for flight hardware. The main concern for calculating reliability is due to the inevitable variability between components combined with the detrimental effects of flight environments (e.g. shock, thermal and vibration). As an alternative, Appendix A-type solutions should be invoked to meet the intent of numerical reliability requirements.
- (2) The reliability of an RTS becomes a safety concern when the vehicle is permitted to continue flight with only one source of tracking. The safety risk involves the probability of the remaining one source producing false position data. Under these conditions, the RSO would be unaware of non-nominal vehicle performance, resulting in a violation of public safety risk criteria. The reliability requirement specified permits loss of the required number of tracking sources (2 for most applications), 3 percent (about one in 33 launches) of the time. This should be an acceptable exposure limit given that the remaining RTS source has a probability of less than 0.1 percent of producing undetectable false position data. However, since the 0.1 percent requirement probability is difficult to demonstrate,

the tailored detailed solutions of this document should be implemented to allow confidence in a remaining source.

- (3) A nominal flight vehicle should be allowed to continue its mission with only one remaining RTS source if that source meets the requirements of this document; specifically, those requirements that demonstrate a high confidence that there are no false position data failure modes. **Note:** These requirements do not include reliability related specifications (i.e. requirements annotated with an “R”) since a loss of data from the final RTS source would be a mission assurance concern (i.e. losing all tracking sources will result in termination of flight). Therefore, tailoring to ensure that a vehicle can continue on one source should concentrate on state vector performance requirements (e.g. accuracy (A), data latency (L) and sample rate (S)).
- (4) A secondary objective is to maintain data tracking during unplanned or non-nominal vehicle RTS performance. These conditions should be evaluated to determine whether the RTS on a non-nominal launch vehicle would provide the required performance up to the point the vehicle breaks up; at which point, the RTS should be functioned. Loss of data during non-nominal vehicle performance may result in delays in terminating a hazardous vehicle, which introduces some added public risk.
- (5) If more sources of tracking are available, then the loss of a single RTS tracking source may not create a safety or mission risk concern. In this case, most reliability requirements within this document can probably be reduced or eliminated.

B2.1.5 RTS Design Life (R) (A)

Degradation of certain components over time can result in changes in reliability and performance. The RTS unit shall function within the specified performance limits throughout its lifetime. The expected degradation should be analyzed to determine effects on range safety mission rules. Even though bench and subsystem level testing may catch most deficiencies, there may be concerns for dynamic environmental vulnerability, which can only be detected during vibration, shock and thermal testing. If a particular RTS unit is susceptible to aging, it may be necessary to limit the time from factory acceptance testing until flight, require testing for reusable vehicles prior to reuse or initiate an age surveillance program. However, in most cases, we are expecting an analysis based on piece-part history will be adequate to address this concern.

B2.1.6.a RTS Piece/Part Selection Criteria (R) (A)

- (1) Experience has shown that screening parts (especially Particle Impact Noise Detection-PIND) is critical in ensuring the necessary performance specifications for high dynamic shock and vibration environments. For vehicles with low vibration and shock environments, piece-part programs are not as critical.
- (2) If the configuration controls requirements of paragraphs 2.1.1, A2.1.1 and B2.1.1 are not tailored such that configuration control is not required, then the requirements of this paragraph may not apply. As described in paragraph 2.1.1,

changes in design (including piece-part substitution with different part numbers or designs can result in unknown performance variations.

B2.1.6.b RTS Voltage and Current Parameters (R) (A) N/C

B2.1.6.c Transient Voltage Generation (R) N/C

B2.1.6.d RTS Voltage Protection (R) N/C

B2.1.6.e RTS Transient Power Susceptibility (R)

Range Safety is concerned that momentary dropouts in power that could cause a loss of all almanac data resulting in a “cold start”. “Cold starts” may take a significant amount of time before an acceptable solution is determined and could seriously affect mission reliability. If almanac data can be preserved in a momentary power fluctuation, it would be expected that reacquisition would occur no later than the “rapid relock” specification. **Note:** It is not Range Safety’s intent to require the RTS unit to function during the power dropout.

B2.1.6.f RTS Continuity and Isolation (R)

B2.1.6.f (1) N/C

B2.1.6.f (2) N/C

B2.1.6.f (3) N/C

B2.1.6.f (4) If the component case is tied to the common electrical return with a low resistance, this can create ground loops. Ground loops can be created when the component is bolted to structure in one vehicle location and the electrical common return provides continuity to another component bolted in different location on the vehicle. Components that are closely located or are isolated from vehicle structure may eliminate this concern.

B2.1.6.g RTS Circuit Isolation (R) N/C

B2.1.6.h RTS Testability (R) (A) (M) (S) (Q) (L) N/C

B2.1.6.i RTS Self-Test Capability (R) N/C

B2.1.6.j RTS Wiring Design (R)

Wiring is singled-out as a unique component since flight harnesses cannot typically be subjected to acceptance environmental stress screening. To ensure flight survivability, Range Safety relies on design and manufacturing controls.

B2.1.6.k RTS Electrical Connector Design (R)

Connectors are singled-out as a unique component since flight connectors (attached to flight harnesses) cannot typically be subjected to acceptance environmental stress screening. To ensure flight survivability, Range Safety relies on design and manufacturing controls.

- (1) N/C
- (2) N/C
- (3) N/C
- (4) N/C
- (5) N/C
- (6) N/C
- (7) N/C
- (8) N/C
- (9) Connectors with chatter exceeding 500 us must be specifically evaluated to ensure that electrical discontinuities created by chatter do not create an unacceptable loss of performance. Specifically, each component being serviced by the chattering connector shall be tested at the worst-case chatter plus a margin to ensure all components and subsystems will function as required.

B2.1.6.1 RTS Power Source Design (R)

Power sources must supply the required voltage and current to RTS components.

- (1) N/C
- (2) When all tracking sources are placed onto a single power source, it is primarily a mission assurance concern; in that, a failure would result in termination of a potentially nominal mission. However, if the same power source also feeds mission assurance components (e.g. guidance computer), then the loss of all tracking sources could also create a failure in the vehicle. For loss of all tracking, mission rules are currently in place to assume an untrackable vehicle has taken a worst-case turn and is heading towards a destruct line. The time it takes to reach the destruct line is calculated and tracking must be reestablished by this time or the vehicle will be terminated. This philosophy assumes that the vehicle will continue to fly stable, though not nominally. For this scenario, safety may be concerned where the vehicle is performing erratically which could disable the FTS. For vehicles that fly a single power source, it is highly suggested that

- mission rules be altered to terminate a mission in a short time (e.g. 5 seconds). This is necessary since a loss of all tracking, most likely, also indicates the vehicle is flying erratically and could disable the FTS if allowed to continue for too long.
- (3) Batteries are singled-out as a unique component since they cannot typically be subjected to acceptance environmental stress screening due to their short wet-life. To ensure flight survivability, Range Safety relies on design and manufacturing controls.
 - (4) Power sources that do not provide the specification voltage and current could cause RTS component degradation of range safety performance requirements.
 - (5) RCC 319 can be obtained from any Range Safety Office.

B2.1.6.m RTS Power Source Monitoring Capability

Batteries are especially susceptible to cold temperatures. To ensure that a battery will provide the correct performance, monitoring within the required accuracy is necessary. Typically the accuracy of the temperature monitoring system shall be factored into the qualification test limits to ensure adequate margin prior to take-off. For example, if a range user wished to launch at forty degrees C with a monitoring accuracy of five degrees C, the battery would have to demonstrate that it could meet minimum performance requirements at thirty-five degrees C (40 degrees C minus 5 degrees). **Note:** Qualifications margins would have to be added to this example.

B2.1.7 Interference Protection (R)

The intent of this requirement is to ensure that the RTS tracking source is capable of performing in the expected environment caused by ground and airborne transmitter sources. Any degradation of tracking performance should be quantified to prevent unexpected tracking results during flight that could result in potential termination of a nominal mission. This requirement is not intended to include anti-spoof technology. In addition, airborne RTS hardware should not radiate or conduct interfering energy to other vehicle components (especially FTS), which could result in unacceptable degradation in performance. This concern is of particular interest for components on the same power bus and RF producing devices that may be susceptible to RTS IF/RF harmonics or vice-versa.

Use of the recommended tailoring in paragraph A2.1.7 is based on experience developed on the Defense Advanced GPS Receiver (DAGR, the new Army handheld) and the Miniature Airborne GPS Receiver (MAGR, installed in the F-18s and F-15s) specifications modified to reflect the latest EMI specification.

B2.1.8 System Delay Time (L)

General Comment: The system delay time is one of the parameters used to determine the current position update of the vehicle. This position update affects how quickly the RSO is able to recognize a launch vehicle failure and detect a violation of destruct criteria. Range Safety generates destruct criteria to contain hazards in a controlled area and ensure public risk criteria

are not violated. Longer delay times result in more uncertainty in position of the vehicle. This uncertainty is factored into the destruct criteria and makes them more conservative. Tracking systems with a long delay time may still be usable for vehicles on benign launch azimuths or slow moving vehicles. For these configurations, tightening of destruct criteria may not affect mission performance. Vehicles equipped with an RTS source employing a long delay time may have the following launch operation's impacts:

- (1) The range user may have to hold or scrub until launch conditions, such as winds or population levels, result in acceptable criteria.
- (2) The vehicle trajectory may have to be changed to account for the increased uncertainty due to data latency; thus, potentially impacting mission capability.
- (3) More conservative destruct lines may not allow a non-nominal vehicle to correct itself and possibly make a useful mission.

B2.1.9 Independence (I)

Independence is a criteria used to determine the acceptability of the tracking system. Range Safety must be certain that when a vehicle position is displayed in real-time, that it is correct. Two independent sources, not using the same hardware/software, can be used to compare one against another to ensure confident tracking. When two sources of tracking are used which are not physically/electrically independent or use identical hardware/software, then there is a safety risk that there are common failures between the sources which could result in both tracking sources producing the same false position data. Under these conditions, a failed vehicle that is violating public risk criteria may appear to be nominal resulting in an unacceptable safety impact. If two tracking sources are coupled in any way, then it still may be possible to use these devices as range safety tracking sources, given that there are no failures of one tracking source which could corrupt the data of the other. Probabilities and severity of failure modes shall be identified to ensure public safety risk criteria are maintained. Vehicles using two non-independent tracking sources require specific range safety evaluation. If a third tracking source is provided (e.g. radar), then this requirement can be significantly reduced or eliminated. However, it is highly recommended that under a three tracking source operational scenario, range users provide confidence in the two non-independent tracking sources, in the event, that the third source is lost. **Note:** The use of two GPS systems as the two sources of tracking using shared antennas could create independence concerns. Specifically, the main characteristics that affect performance would be common to both GPS receivers (e.g. common view satellites, signal strength and moment arms). A better solution would utilize two sets of orthogonal antennas each feeding a dedicated GPS unit.

B2.1.10 Accuracy (A)

General. The accuracy is one parameter that affects how quickly the RSO is able to recognize a launch vehicle failure and detect a violation of destruct criteria. Range Safety generates destruct criteria to contain hazards in a controlled area and ensure public risk criteria is not violated. Range Safety typically utilizes instantaneous impact points (IIP) based on where the vehicle will impact not just its present position and velocity. Because most GPS vendors are unfamiliar with this calculation, we have used a recommended solution that uses present

position/velocity for their benefit. It is the range users responsibility to ensure that any present position/velocity requirements placed on a vendor will meet the vehicle program objectives. An example of the range user specification (using IIP) is contained in paragraph A2.1.10. Using this type of specification also allows the range user to trade velocity and position accuracy to meet the overall program objectives. Higher inaccuracies result in more uncertainty in position of the vehicle. This uncertainty is factored into the destruct criteria and may make them more conservative. Some general comments are as follows:

- (1) Vehicle accuracy requirements are not usually constant throughout flight. In general, there are critical portions of flight, which require high accuracies and others that do not. This situation may be used to allow a vehicle to launch with a lower accuracy than that which may be required at later times in flight (or vice-versa) given a certain satellite constellations.
- (2) Accuracy specifications (including velocity and present position) are one of many parameters used to predict instantaneous impact point (IIP) of debris throughout flight. It is the IIP, not the present position and velocity that are used to develop destruct criteria to protect the public. **Note:** Variables such as ballistic coefficients, winds and ballistic trajectories of fast moving vehicles can cause, what appears to be a negligible inaccuracy in present position, to manifest itself as a significant safety impact in the IIP domain. Range users need to work with Range Safety to ensure all safety criteria are addressed.
- (3) Low accuracy tracking systems may still be usable under the following limitations:
 - i.* The range user may have to hold or scrub until launch condition, such as winds or population levels, result in acceptable criteria.
 - ii.* The vehicle trajectory may have to be changed to account for the increased uncertainty in position and velocity; thus, potentially impacting mission capability.
 - iii.* More conservative destruct lines may not allow a non-nominal vehicle to correct itself and possibly make a useful mission.
 - iv.* Vehicles on benign launch azimuths or slow moving vehicles may not require high accuracy. For these configurations, tightening of destruct criteria may not affect mission performance.

a. Failing to define RTS performance during non-nominal vehicle flight could result in a errant vehicle reporting false position data. Under this condition, an RSO might not have the required RTS data necessary to terminate a vehicle that has violated boundaries to protect the public. There are two methods that address non-nominal vehicle accuracy performance:

- (1) Determine non-nominal vehicle performance parameters by evaluating credible failure modes (i.e. tumble induced by hard-over engine nozzle and maximum stable turn). Ensure an RTS can perform within specification during these dynamic events.
- (2) The RTS system is capable of autonomously determining when its state vector is not in specification and alerting a Range Safety operator in real-time.

b. A secondary objective is to maintain the required performance throughout non-nominal vehicle flight. Failure to track during non-nominal vehicle flight could result in a delay in terminating an uncontrolled vehicle. In the absence of all data, the RSO will usually assume the vehicle has taken a worst-case turn towards a destruct line and wait for the time it would take for the vehicle to reach the destruct line unless tracking is reestablished. However, the time it takes a non-nominal vehicle to reach a destruct line can be quite extensive. During this time, an uncontrolled vehicle, that is allowed to continue flight, could impart maneuvers that could disable the FTS. The ability to maintain FTS functionality during non-nominal vehicle events must be evaluated on a case-by-case basis and it may be necessary to establish mission rules to terminate a vehicle if all sources of tracking are lost.

c. Though the recommended solution offered will not apply to most vehicles, the format used in this paragraph to characterize RTS accuracy should be similar. This format shows the actual range safety requirement in instantaneous impact space. However, most RTS vendors would not be able to apply this type of requirement; therefore, typical present position and velocity recommendations have been added for their benefit. It is the range user's (program) responsibility to ensure that the present position/velocity requirements levied on the vendor will meet range safety instantaneous impact requirements.

B2.1.11 N/C

B2.1.12 The number of tracking sources will be determined during the tailoring process using various inputs such as vehicle trajectory, hazard potential, dynamics and reliability.

B2.2 RTS Airborne Environmental Performance Requirements (R)(I)(M)(A)(S)(L)(Q)

***a.* RTS Component Maximum Predicted Environment (R) (A) (L) (S) (Q).**

Measured flight data should be taken from locations from each RTS location. These functions are used to translate vibration levels from a known (measured) location to an unknown location. Transmissibility functions should be validated using the proposed analytical approach and calculating a transfer function between two known locations measured in flight. If the calculated and measured transfer functions agree, then the model can be assumed to be correct. **Note:** Transfer functions shall be validated for each vehicle location; comparisons should only be used within representative locations on the vehicle structure. For safety critical applications, the 4 dB uncertainty margin used for vibration is consistent with the margin used in RCC 319. An example of a safety critical application includes the use of the RTS as part of an input to an autonomous destruct system.

***b.* RTS Component Random Vibration Environment (R) (A) (L) (S) (Q).** For purposes of this document, the MPE is defined as the P95|50 vibration level. Recommended test margins should be modified accordingly if a different statistical level is utilized.

c. N/C

d. N/C

e. N/C

***f.* Other RTS Component Environments.** These environments are typically performed by analysis and are not routinely tested for most vehicle applications. In addition, the test level and duration margins are typically unique to each vendor; therefore, each range user

should recommend a suitable technical approach to address specific test criteria. The criticality and need to perform testing should be handled on a case-by-case basis.

g. **RTS Environmental Survivability.** Range Safety is concerned about vehicle tracking performance when the vehicle is performing non-nominally. This requires the RTS to function within the requirements of this document during non-nominal or erratic flight conditions. For example, RTS components that produce unverifiable out-of-specification state vector data during erratic vehicle flight could produce public safety hazards. To accomplish this, design margins are added to the expected environmental exposure to account for the following:

- (i) Vehicle breakup environmental uncertainty
- (ii) To ensure acceptance test environmental stress screening does not damage flight hardware.
- (iii) Manufacturing variability between qualification and production units. This variability may cause susceptibility to flight hardware resulting in a failure to meet range safety critical performance criteria.

h. **RTS Shock and Vibrational Mounted Isolation Systems Design (R) (A) (L) (S) (Q).** Many vibration isolation systems have shown to significantly amplify vibration environments at resonant frequencies. Therefore, placing a component on isolators can actually increase susceptibility of a RTS component vibration induced failure. Once a component is qualified based on certain isolator performance characteristics, it is critical that flight isolators are selected to ensure that the RTS component is not exposed to environments, for which it was not qualified. By controlling the range of the natural frequency variation as well as the amplification (Q) at that frequency, the component can be protected against unqualified environments.

B2.3.1.1 Airborne RTS Antenna System General Performance Requirements (R) (A)

It is recognized that such dropouts can be unavoidable for certain situations such as captive carry, liftoff, staging, and plume attenuation. This requirement is to ensure that such dropouts have been analyzed, anticipated, and accepted by the range. Data from this analysis will be factored into the mission rules to ensure that expected dropouts are mistakenly interpreted.

B2.3.1.2 Airborne GPS Receive Antenna System (GPS Satellite to Launch Vehicle) (R) (A)

- a.* N/C
- b.* N/C
- c.* N/C

d. Vehicle tracking is critical during non-nominal vehicle flight. Although flight rules can be set-up to terminate a vehicle if tracking is lost, vehicles can also be allowed to continue at the increased risk of the public. Vehicles that are allowed to continue flight with no tracking data have the increased risk of an erratic flight damaging or disabling the FTS. Therefore, it is highly recommended to maximize GPS tracking capability by providing a positive link margin over 95 percent of the spherical coverage of the downlink antenna system. **Note:** It is understood that the required DOP may not be maintained during non-nominal vehicle flight.

B2.3.1.3 Airborne RTS Transmit Antenna System (Vehicle to Ground) (R) (L)

- a. N/C
- b. N/C
- c. N/C

d. Vehicle tracking is critical during non-nominal vehicle flight. Although flight rules can be set-up to terminate a vehicle if tracking is lost, vehicles can be allowed to continue at the increased risk of the public. This requirement can be met by providing a positive link margin over 95 percent of the spherical coverage of the downlink antenna system.

B2.3.2 GPS Receiver Performance Requirements (R) (I) (M) (A) (S) (L) (Q)

a. **Maximum Dynamic Range (R) (A).** All performance parameters shall remain in specification when subjected to the lowest and highest RF input signal level (C/N_0). Performance parameters that should be given special attention include: immunity to in-band interfering signals, Time to first fix and reacquisition capability.

b. **Input Voltage (R)(A)(L).** Changes in input voltage could create performance variation. It is necessary to ensure that any performance degradation induced by flight voltage variations do not result in failure to meet range safety performance requirements. Open circuit voltage is included since unloaded voltage creates an artificially high voltage, which can damage RTS hardware upon initial turn-on.

c. **Navigation Data Validity (R) (A) (D) (L) (S) (M) (Q).** RTS components with failure modes that create real-time undetectable out-of-specification performance data could create a condition that endangers public safety. If a non-nominal launch vehicle is believed to be nominal, through some RTS failure mode, a flight may be allowed to continue when the mission should be ended. If the failure modes of an RTS are unknown (e.g. Commercial Off-The-Shelf-COTS), then this puts an added burden on safety should a failure in another tracking source leave only one tracking source available. In this condition, flight rules may need to be made more conservative to protect the public or Range Safety may allow continued flight on a case-by-case basis. It is the intention of this requirement to quantify the potential failure modes, such that, mission rules can be developed prior to flight and are mutually acceptable to Range Safety and the range user.

d. **Immunity to Interfering Signals (R).** This performance criterion concentrates on expected radiating sources in the flight environment to ensure that no unacceptable performance degradation occurs during flight. Since this is a component-level specification, the effect of system-level conducted and radiated energy to the GPS component shall be determined. This specification is not intended to address anti-spoofing. It is intended to address expected frequency sources, include harmonics, generated at the launch site and launch vehicle. Interfering RF signals should be analyzed to ensure that they would not affect GPS performance.

- e. **State Vector (A)** See B2.1.10
- f. **Sample Rate (S)** See B2.1.3
- g. **Delay Time (L)** See B2.1.8

h. **Measurement Set (M) (Q).** Downlink information may include data necessary for differential GPS correction (e.g. pseudo-ranges and covariance matrices). In addition, adequate data needs to be provided in real-time to determine if a GPS solution is not meeting performance parameters (i.e. producing false position data).

i. Rapid Re-Lock Capability (L) (R) (A). Rapid re-lock may be a concern when momentary events occur causing loss of GPS lock (e.g. lift-off motor ignition, payload fairing separation and stage separation). The time to reacquire should be addressed during mission planning to prevent unexpected degradation in real-time tracking performance. Reacquisition may become a concern for vehicles that do not have acquisition of the appropriate number of satellites prior to launch (silo, submarine launch, canister or launch pad with interfering structures). It may be possible to launch with less satellites than necessary as long as the required constellation can be acquired prior to the Minimum Time to Endanger (MTE). The MTE criteria represent the time required for a non-nominal vehicle to endanger life or property. As long as the required constellation can be achieved before MTE, then a launch may be allowed to continue.

j. Time to First Fix (R) (A). Time to first fix is associated with a “cold start” of a GPS receiver. This requirement is mainly a mission launch-on-time issue. It is recommended that the GPS receiver have some data input (e.g. ephemeris, timing, initial position) to minimize search acquisition times.

k. De-Selection of Faulty Satellites (R) (A) (Q). This requirement is not intended to require RAIM (although RAIM is an acceptable solution) but to ensure that there are no single failures, which could create undetectable false position data. **Note:** If a receiver is capable of generating false position data with the failure of one satellite and there is no manner within the receiver for detecting this anomaly, the probability of this occurrence could be used as a supporting rationale for acceptance. This requirement is more important for missions that last for a significant amount of time (e.g. two-week missions for Unmanned Aerial Vehicles) where the probability of having a failure is considerably higher than that of short-duration missions. For short duration missions, it is expected that this requirement will only be highly desired and not required. This requirement shall be addressed on a case-by-case basis with each individual range for each specific vehicle application.

l. Acquisition Capability (R). Sensitivity performance includes characteristics other than simply closing the RF link (C/N_0) under nominal conditions. Adequate signal strength shall be available to guarantee the performance of other parameters such as accuracy, time to first fix, in and out of band rejection and rapid relock. In addition, the ability to maintain performance requirements during vehicle environmental conditions (e.g. thermal, shock, acceleration and vibration) shall also be ensured at the worst-case expected C/N_0 . Another consideration is ensuring that adequate C/N_0 exists to prevent output of false position data caused by improper TM decommutation.

m. N/C

B2.3.2 Other General Miscellaneous Candidate Requirements

a. N/C

b. N/C

c. N/C

d. N/C

e. N/C

f. Phase Jitter (R) (A). Phase jitter can translate into position and velocity inaccuracies as a result of several environmental factors. Of particular interest are reference oscillator fluctuations during dynamic operating environments that can cause significant performance

degradation. The effects of phase jitter should be characterized to prevent an unacceptable degradation in performance when subjected to flight environments. Phase jitter can be determined inferentially by utilizing pseudorange measurements.

- g* N/C
- h* N/C

B2.3.3 Ground Translator Processor (GTP) Receiving/Processing Performance Requirements

a. Maximum Dynamic Range (R) (A). All performance parameters shall remain in specification when subjected to the lowest and highest RF input signal level (C/N_0). Performance parameters that should be given special attention include: immunity to in-band interfering signals, Time to first fix and reacquisition capability.

b. Navigation Data Validity (R) (A) (D) (L) (S) (M) (Q). GPS components with failure modes that create real-time undetectable out-of-specification performance data could create a condition that endangers public safety. If a non-nominal launch vehicle is believed to be nominal, through some RTS failure mode, a flight may be allowed to continue when the mission should be ended. If the failure modes of an RTS are unknown (e.g. Commercial Off-The-Shelf-COTS), then this puts an added burden on safety should a failure in another tracking source leave only one tracking source available. In this condition, flight rules may need to be made more conservative to protect the public or Range Safety may allow continued flight on a case-by-case basis. It is the intention of this requirement to quantify the potential failure modes, such that, mission rules can be developed prior to flight and are mutually acceptable to Range Safety and the range user.

c. Immunity to Interfering Signals (R). This performance criterion concentrates on expected radiating sources from ground transmitting equipment. It is intended to address expected frequency sources, include harmonics, generated at the launch site. Interfering RF signals should be analyzed to ensure that they would not affect tracking performance. This frequency analysis should include harmonics of all frequency sources. The GPS translator ground hardware shall be able to function with any airborne re-radiated or ground station interfering RF energy.

d. State Vector (A). See B2.1.10

e. Data Rate (S). See B2.1.3

f. Delay Time (L). See B2.1.8

g. Measurement Set (M) (Q). In addition to performance state vector data, adequate data needs to be provided in real-time to determine if a tracking solution is not meeting performance parameters (i.e. producing false position data). If the GTP data is to be differentially corrected, then it must also meet the requirements of the differential GPS section of this document.

h. Rapid Re-Lock Capability (L) (R) (A). Rapid re-lock may be a concern when momentary events occur causing loss of GPS lock (e.g. lift-off motor ignition, payload fairing separation and stage separation). The time to reacquire should be addressed during mission planning to prevent unexpected degradation in real-time tracking performance. Reacquisition may become a concern for vehicles that do not have acquisition of the appropriate number of satellites prior to launch (silo, submarine launch, canister or launch pad with interfering structures). It may be possible to launch with less satellites than necessary as long as the required constellation can be acquired prior to the Minimum Time to Endanger (MTE). The

MTE criteria represent the time required for a non-nominal vehicle to endanger life or property. As long as the required constellation can be achieved before an MTE, then a launch may be allowed to continue.

i. Time to First Fix (R) (A). Time to first fix is associated with a “cold start” of a GTP system. This requirement is mainly a mission launch-on-time issue. It is recommended that the GPS receiver have some data input (e.g. ephemeris, timing, initial position) to minimize search acquisition times.

j. De-Selection of Faulty Satellites (R) (A) (Q). This requirement is intended to ensure that there are no single failures, which could create undetectable false position data. **Note:** If an GTP is capable of generating false position data with the failure of one satellite and there is no manner within the GTP for detecting this anomaly, the probability of this occurrence could be used as a supporting rationale for acceptance. This requirement is more important for missions that last for a significant amount of time (e.g. two-week missions for Unmanned Aerial Vehicles) where the probability of having a failure is considerably higher than that of short-duration missions. For short duration missions, it is expected that this requirement will only be highly desired and not required. This requirement shall be addressed on a case-by-case basis with each individual range for each specific vehicle application.

k. Acquisition Capability (R). Sensitivity performance includes characteristics other than simply closing the RF link (C/N_0) under nominal conditions. Adequate signal strength shall be available to guarantee the performance of other parameters such as accuracy, time to first fix, in and out of band rejection and rapid relock. In addition, the ability to maintain performance requirements during vehicle environmental conditions (e.g. thermal, shock, acceleration and vibration) shall also be ensured at the worst-case expected C/N_0 . Another consideration is ensuring that adequate C/N_0 exists to prevent output of false position data caused by improper TM demodulation.

l. Quality/Confidence Indicators (R)(Q). N/C

m. Warm up time (A) (L). Warm up time is important to ensure that the GTP has sufficient time to stabilize prior to launch. This specification would be levied on the GTP prior to launch.

Other General Miscellaneous Candidate Requirements

(1) Compatibility should include all parameters necessary to ensure reliable transfer of data. Adequate margin should be considered in critical parameters to account for variations in ground and airborne hardware performance. Items that need be considered include: Center frequency deviation, frequency bandwidth variations, data rate, link closure power and data format.

(2) N/C

B2.3.4 Differential GPS (DGPSS) Systems Performance Requirements

a. The range user shall ensure that the airborne systems are compatible with the range ground receiving station. It is recommended that a standard format be utilized throughout all programs and ranges to minimize the need for airborne and ground modification to COTS systems.

b. State Vector (A). Differential GPS is used when it is not possible to meet accuracy requirements with standard C/A code. When evaluating differential GPS performance, the

ground and airborne segments shall be considered one system when assessing compliance to range safety performance requirements.

c. State Vector Data Rate (S). The data rate downlink specification shall include data other than the TSPI information. Other parameters critical in ensuring differential GPS performance (see B2.3.4d below) shall also be provided at a rate that will meet range safety performance requirements. **Note:** TSPI and supporting differential GPS data rates do not necessarily have to be the same.

d. Measurement Set (M). Inputs from airborne GPS receivers include data parameters other than TSPI data (e.g. pseudo-range measurements and covariance matrices). The range user shall ensure that the airborne GPS hardware can deliver the required data necessary for Differential GPS to function within specification.

e. De-Selection of Faulty Satellites (R) (A) (Q). Differential GPS has additional capacity to deselect faulty satellites over stand-alone airborne GPS receivers.

B2.3.5 Airborne Inertial Measurement Unit (IMU) Performance Requirements (R) (I) (M) (A) (S) (L) (Q)

General:

- (1) This section was primarily intended for IMU tracking systems that are independent of vehicle guidance systems. However, due to potential in-flight failures of other RTS sources, Range Safety may be asked to allow a vehicle to continue flight with only one remaining source. If this source is the vehicle guidance system, then supporting data is necessary to allow an assessment of the public risk. This assessment should concentrate on whether the vehicle guidance has any failure modes or a high probability of producing false position data. To allow a nominal flight vehicle to continue its mission with only the vehicle guidance as its sole source of tracking, the vehicle guidance should meet the requirements of this document. Specifically, those requirements that demonstrate a high confidence that there are no false-position failure modes must be quantified. These requirements do not include reliability related specifications (i.e. requirements annotated with an “R”) since a loss of data from the final RTS source would be a mission assurance concern (i.e. losing all tracking sources will result in termination of flight). Therefore, tailoring to ensure that a vehicle can continue on one source should concentrate on state vector performance requirements (e.g. accuracy (A), data latency (L), sample rate (S) and failure modes that would adversely affect these parameters).
- (2) The potential and specific interface between the range and the user’s Integrated GPS/Inertial tracking system depends on the system design and implementation. Designs include where the GPS is used to continuously calibrate the inertial measurements, and the inertial aids GPS track during high dynamic change or reacquisition after periods of dropout. (If this design can cause either instrument to drive the other instrument off-track, it is not recommended for the range safety application.) Another common design uses the GPS to calibrate the inertial measurements, but does not include inertial feedback to the GPS receiver. Properly designed and implemented, the integrated GPS/IMU could provide an adequate source of vehicle position, velocity, acceleration, attitude and attitude rate for vehicle navigation reference and independent dual tracking sources for range safety if the

IMU instrument was of navigation quality and GPS dropouts were not excessive. Additional confidence may be obtained if the native measurements (Inertial sensed force, accumulated velocity, angular rates, accumulated angular rates, inertial to vehicle body quaternion and GPS pseudo-range, delta pseudo-range or Doppler) are transmitted to the range and processed for Range Safety display.

a. Alignment and Calibration (R) (A) (D) (L) (S) (M) (Q). Incorrect alignment/calibration can cause the IMU to report undetectable out-of-specification position data. Calibration of the inertial instrument occurs at several stages in its life: during its assembly and factory acceptance tests; after its integration on the launch vehicle, and for the coupled GPS/Inertial application, calibration of a critical subset (inertial platform alignment, accelerometer bias and scale factor, and gyro drift and scale factor are typical) of the error model describing the instrument performance occurs during flight. Among other reasons, calibration during assembly confirms the mathematical error model describing the instrument's expected performance; documentation developed during factory acceptance tests confirms performance of the specific instrument under test; inertial platform alignment and leveling to local gravity occurs during the pre-launch sequence; and as noted above, potentially continuous calibration may occur during flight to enhance or maintain accuracy. (Complex post-mission data processing is conducted to evaluate weapons system inertial instrument performance and to confirm higher order acceleration sensitive terms of the representative mathematical error model.) An exhaustive discussion of inertial instrument calibration techniques is not provided here, but does differ somewhat between gimballed and strap-down inertial systems. Documentation describing the performance of the following generic inertial instrument subsystems is required to satisfy the question of whether the system can be considered an adequate source for range safety, either as a stand-alone or only during those periods of expected GPS track dropout.

- (1) **Gyro Scale factor errors (R) (A).** Causes degradation in the measure of angular change.
- (2) **Gyro drift rate (R) (A).** Drift causes degradation in attitude reference.
- (3) **Gyro input axis alignment errors. (R) (A).** Causes correlation error when measurements are transformed into attitude orientation.
- (4) **Other gyro error sources (R) (A).** Documented calibration results provide information required to determine system performance and whether system is acceptable as an "adequate" metric source for Range Safety.
- (5) **Accelerometer scale factor (R) (A).** Scale factor error causes a velocity and position error when acceleration is integrated.
- (6) **Accelerometer bias (A).** Causes an erroneous measure of sensed force, may be additive with each sampling, and will result in velocity and position errors when integrated.
- (7) **Accelerometer axis misalignment (A).** Causes a correlation error in velocity and position when sensed force is integrated.
- (8) **Other accelerometer error sources (A).** Documented calibration results provide information required to determine system performance and whether the system is acceptable as an "adequate" metric source for Range Safety.

(9) Operating Temperature (R). Documented calibration results confirm design parameters and shall be adhered to in application to produce repeatable performance.

(10) Initialization (M)(A). N/C

(11) Warm up time (A) (L). Same as (9) above.

(12) Alignment Verification. Alignment can be an especially important parameter for Range Safety. Because alignment performs the critical process of aligning the vehicle IMU axes to axes used in the navigation process (example – inertial coordinate frame fixed at earth center), proper alignment is essential to precise tracking. Because vehicle guidance and control systems operate closed-loop, a misaligned vehicle can provide false position data. Several techniques of alignment are available.

b. Input Voltage (R) (A) (L). Changes in input voltage could create performance variation. It is necessary to ensure that any performance degradation induced by flight voltage variations do not result in failure to meet range safety performance requirements. Open circuit voltage is included since unloaded voltage creates an artificially high voltage, which can damage RTS hardware upon initial turn-on.

c. Gyro Rate Limits (S). Intent is to protect against out-of-specification instrument outputs, which could lead to false position data. Non-nominal vehicle dynamics (see Breakup Analysis) should be compared against gyro specification values to ensure non-nominal vehicle flight does not produce an undetectable out-of-specification state vector. This requirement is primarily concerned with mechanical gimballed gyros.

d. Accelerometer Limits (R) (A). Intent is to protect against out-of-specification instrument outputs, which could lead to false position data. Non-nominal vehicle dynamics (see Breakup Analysis) should be compared against accelerometer specification values to ensure non-nominal vehicle flight does not produce an undetectable out-of-specification state vector. Design capability shall be consistent with intended applications.

e. Navigation Data Validity (R) (A) (D) (L) (S) (M) (Q). RTS components with failure modes that create real-time undetectable out-of-specification performance data could create a condition that endangers public safety. If a non-nominal launch vehicle is believed to be nominal, through some RTS failure mode, a flight may be allowed to continue when the mission should be ended. If the failure modes of an RTS are unknown (e.g. Commercial Off-The-Shelf-COTS), then this puts an added burden on safety should a failure in another tracking source leave only one tracking source available. In this condition, flight rules may need to be made more conservative to protect the public or Range Safety may allow continued flight on a case-by-case basis. It is the intention of this requirement to quantify the potential failure modes, such that, mission rules can be developed prior to flight and are mutually acceptable to Range Safety and the range user.

f. State Vector (A). See B2.1.10. The IMU shall provide data of sufficient quality and quantity to produce an inertial derived trajectory estimate adequate for Range Safety during the period of GPS solution dropouts.

g. Data Rate (S). See B2.1.3.

h. Delay Time (L). See B2.1.8.

i. Measurement Set (M) (Q). *On occasion, raw inertial measurements data may be required to allow independent processing of state vector data at ground stations. This type*

of processing can be used to mitigate concerns associated with flight hardware failure modes that could produce undetectable out-of-specification state vector tracking data. Telemetry dropouts historically occur at vehicle staging events and occasionally for other reasons. Non-destructive readout accumulator registers with sufficient roll over capability permits the bridging of expected telemetry dropouts without accuracy degradation. This allows reconstruction of inertial guidance data, which may be necessary in certain cases such as failure investigations.

B2.3.6 RF Downlink Performance Requirements (R) (M) (Q) (S)

General: An RF downlink requirements apply to any data handling and transmission system used to deliver range safety required airborne vehicle data. For RTS systems with integrated downlink capability, the requirements of this section apply to the data handling and RF transmission portion of the integrated component. An RF downlink should be considered as part of the RTS, since, without it, the RTS is unusable. Fortunately, most TM failure modes result in a loss of data versus producing false position data. Therefore, for most program TM applications, the ability to reliably transfer data is the only concern.

*a. **Generation of Interfering Signals (R).*** TM downlink systems can generate signals that are in addition to the carrier center frequency. These spurious signals can be conducted through shared component wiring or through RF transmission. These spurious signals should be analyzed or tested to ensure that other components are not adversely affected. **Note:** Other components may be susceptible to frequencies other than those that they were primarily intended to function. In addition, failure modes within TM system should be analyzed to ensure that a single failure within the TM system would not affect RTS, FTS or launch vehicle functionality.

b. N/C

c. N/C

*d. **RF Downlink Characteristics (R).*** The airborne TM system shall interface with the ground support equipment to support all range safety performance requirements. In addition, the airborne TM downlink system performance specification variations should be analyzed to ensure that airborne TM system specification deviations can be supported by range ground support equipment including performance variations due to flight operating environments.

(1) N/C

(2) N/C

(3) N/C

(4) N/C

(5) **Power Output (R).** It is recommended to use a 95 percent spherical coverage antenna pattern in the RF link analysis. This antenna coverage will maximize the ability to collect data under non-nominal vehicle flight. Downlink data can be used to allow a non-nominal vehicle to continue flight, collect data for vehicle failure analysis and to determine whether the FTS functioned nominally if safety commands are sent. If data is lost during a violent vehicle event (e.g. twisting and tumbling), the RSO may be unaware of the vehicle dynamics (due to loss of all data) and wait until the vehicle could have theoretically crossed a destruct line.

Allowing a vehicle to fly erratically for an extended period of time could result in loss of FTS capability; thus, creating a safety hazard.

(6) N/C

(7) N/C

(8) **Fault Tolerance(R)**. It is highly recommended that each TM link (when two TM links are used) contain all sources of tracking and vehicle health so that all data remains available to the RSO given a single TM failure. **Note:** Loss of all data is a safety concern when an RSO may allow the vehicle to continue until the Minimum Time to Endanger (MTE) is exceeded. The MTE represents the time it would take for an errant vehicle to violate public safety criteria. If an RSO allows a non-nominal vehicle to continue until MTE (which could be a significant amount of time), the FTS could be disabled and public safety criteria could be violated. Ground-rules could be determined during mission planning to automatically terminate flight should a loss of all data occur. The time of data loss should ensure that the FTS couldn't be disabled given a high dynamic vehicle failure; a typical value would be less than 10 seconds. With this ground-rule, it may be possible to minimize or delete downlink requirements. Redundancy for passive antennas and couplers is not considered critical due to the reliable flight history and robust design of these devices. **Note:** This is consistent with passive FTS antennas and coupler, which are not required to be redundant.

(9) N/C

e. **Measurement Set (M)**. The data rate includes TSPI sample rate requirements as well as any other data critical in ensuring GPS performance (e.g. differential GPS and status-of-health).

B2.3.7 Coupled GPS/Inertial System Performance Requirements

a. **Raw GPS Data. (R) (I) (A) (Q)**. N/C

b. **Quality Indicator (R) (I) (A) (Q)**. N/C

c. **Stand-alone Observability. (R) (I) (A) (Q)**. N/C

d. **Independence. (I)**. N/C

e. **Time Tags (L)**. For range safety, the IMU internal clock counts would be redundant if the GPS receiver successfully acquired track. However, they would be essential if the GPS did not acquire and would be useful for refined post-mission data processing.

f. **Initialization (M) (A)**. N/C

B2.3.8 Airborne GPS Translator With Transmitter Performance Requirements (R) (I) (M) (A) (S) (L) (Q)

a. **Maximum Dynamic Range (R)(A)**. The translator must be capable of processing the worst-case high and low L-band RF power input. The downlinked signal provided to the GTP shall be capable of meeting all range safety performance requirements.

b. **Input Voltage (R)(A)(L)**. Changes in input voltage could create performance variation. It is necessary to ensure that any performance degradation induced by flight voltage variations do not result in failure to meet range safety performance requirements. Open circuit voltage is

included since unloaded voltage creates a short-duration artificially high voltage, which can damage the translator hardware upon initial turn-on.

c. **Immunity to Interfering Signals (R).** This performance criterion concentrates on expected radiating sources in the flight environment to ensure that no unacceptable performance degradation occurs during flight. The translator shall be capable of rejecting interfering RF signals, which could affect tracking performance.

d. **Delay Time (L).** See B2.1.8.

e. **Warm up time (A) (L).** Warm up time is important to ensure that the translator has sufficient time to stabilize prior to launch. This specification would be levied as a launch vehicle constraint.

e. **Generation of Interfering Signals (R).** TM downlink systems can generate signals that are in addition to the carrier center frequency. These spurious signals can be conducted through shared component wiring or through RF transmission. These spurious signals should be analyzed or tested to ensure that other components are not adversely affected. **Note:** Other components may be susceptible to frequencies other than those that they were primarily intended to function. In addition, failure modes within TM system should be analyzed to ensure that a single failure within the TM system would not affect RTS, FTS or launch vehicle functionality.

f. **RF Downlink Characteristics (R).** The airborne downlink system shall interface with the ground support equipment to support all range safety performance requirements. In addition, the airborne TM downlink system performance specification variations should be analyzed to ensure that airborne TM system specification deviations could be supported by range ground support equipment including performance variations due to flight operating environments.

(1) N/C

(2) N/C

(3) **Power Output (R).** It is recommended to use a 95 percent spherical coverage antenna pattern in the RF link analysis. This antenna coverage will maximize the ability to collect data under non-nominal vehicle flight. Downlink data can be used to allow a non-nominal vehicle to continue flight, collect data for vehicle failure analysis and to determine whether the FTS functioned nominally if safety commands are sent. If data is lost during a violent vehicle event (e.g. twisting and tumbling), the RSO may be unaware of the vehicle dynamics (due to loss of all data) and wait until the vehicle could have theoretically crossed a destruct line. Allowing a vehicle to fly erratically for an extended period of time could result in loss of FTS capability; thus, creating a safety hazard.

(4) **Bit Error Rate (R).** The 10^{-2} BER is necessary to keep the correlators locked on a spread-spectrum signal. The nature of the correlation process is forgiving for a BER of up to 5×10^{-2} . This is different than the BER needed for telemetry.

(5) **Link Closure (R).** The values specified in Appendix A2.3.7 g(6) represent current GTP performance capability. Therefore, by meeting these minimum S/N requirements, a translator should be able to interface with most existing range assets with no modification.

B2.4 RTS Ground Support and Monitoring Equipment Design Requirements

Data should be made available to trained personnel to ensure the RTS tracking system is performing nominally prior to launch. **Note:** Typically a range user monitors these parameters with little or no Range Safety oversight. The need for Range Safety monitoring of the RTS should be handled on a case-by-case basis.

B3.0 Performance Verification Requirements

There are many processes to verify compliance to range safety critical performance requirements. In many cases, testing is not necessary and analyses that demonstrate that the component is not affected by the particular requirement are adequate to demonstrate compliance. Each recommended solution in Appendix A should be assessed to determine if a test is required to validate a required range safety performance parameter.

*a. **Test Plans/Procedures.*** In our experience, most misunderstandings occur during the implementation of top-level performance test requirements. The detailed procedures, which implement top-level performance requirements, shall ensure that there are no deficiencies that can result in an unacceptable safety hazard. Range Safety has significant test experience and is cognizant of which areas are most likely to be a concern. If range users implement detailed procedures without Range Safety review, there is a chance a deficiency may occur. As a result, retesting or waivers may be required to address safety noncompliance.

*b. **Retest Requirements.*** If a qualification test failure occurs, it may or may not be necessary to reperform all previous testing. The major consideration is the cumulative effects from all the previous tests that may have contributed to the failure. It is often necessary to reperform all previous applicable tests that may have contributed to a failure. Similarly for acceptance test failures, the extent of a rework determines whether the testing should be reperformed. In general, any rework that is sensitive to workmanship deficiencies should be retested (e.g. soldering/desoldering, removing electronic PC boards, replacement of piece-parts and depotting/repotting). It is important that any rework be demonstrated to be free of workmanship defects.

*c. **Failure to Meet Component Specifications.***

- (1) Some workmanship or design deficiencies exhibit themselves as out-of-family measurements. These anomalies may, in themselves, allow a unit to pass functional performance tests. However, the ability to survive vehicle flight environmental exposure may be questionable. It is critical that any deviations from expected values (whether in or out-of-specification) be analyzed to determine if a flight hardware defect exists which could degrade further in flight. Flight hardware anomalies should also be analyzed to determine if they are generic to other identical/similar hardware. Determination of out-of-family data must be determined by the range user or vendor. Range Safety may also address out-of-family results after reviewing test reports.
- (2) COTS hardware, which varies in design from unit-to-unit, may exhibit out-of-family performance as a result of design changes. As a result, there is often a

tendency to make specification limits considerably loose to allow for these variations plus a margin. Unfortunately, this can result in the acceptance of degraded hardware for flight. The pass/fail for variations in COTS performance limits must be addressed on a case-by-case basis. However, any significant performance variation (i.e. out of family) must be subjected to a failure analysis and corrective action.

(3) N/C

(4) N/C

d. Testing Prior to Qualification. Acceptance testing is typically performed prior to qualification testing to ensure there are no workmanship deficiencies prior to entering qualification. Therefore, if a qualification test failure occurs, it can be assumed to be a generic design deficiency. If acceptance testing is not performed before qualification, it puts into question any qualification test failure on whether it was a screenable workmanship deficiency or a generic design problem.

e. Test Tolerances.

- (1). The intent of using test tolerances is to maintain an environmental margin between flight hardware environmental exposure (i.e. acceptance testing and flight) and demonstrated design survivability (i.e. qualification test level). If the environments experienced by flight hardware exceed the demonstrated survivability level, then the component cannot be guaranteed to be “flight worthy”. Test tolerances should utilize a worst-case tolerance stack-up (e.g. minimum qualification test level and maximum acceptance test level-see Figure B3.0-1 below) to ensure that the specification environmental margin is maintained. For example, the recommended margins in Appendix A use a 6 dB qualification margin with ± 1.5 dB tolerance; yielding a 3 dB margin between maximum acceptance and minimum qualification. If a ± 2.0 dB tolerance was desired, the qualification margin should be increased to 7 dB.
- (2). In addition, vibration bandwidth sampling can have the effect of “averaging” peaks and valleys (see Figure B3.0-2 below). If these bandwidths are set too wide, high peaks can be masked resulting in test levels that may not be indicative of actual flight levels. The recommended bandwidth sampling criteria in Appendix A attempts to retain actual flight data peaks without unnecessarily driving qualification test levels.

Figure B3.0-1. Example of Vibration Test Margin and Tolerances

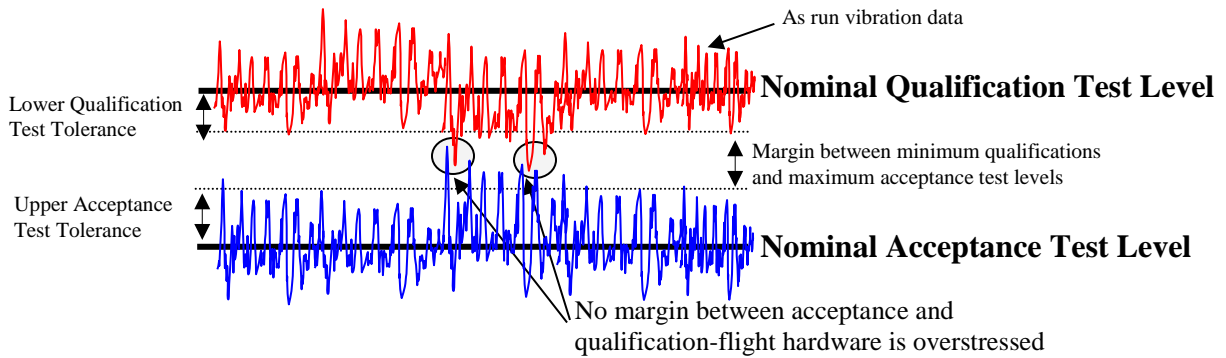
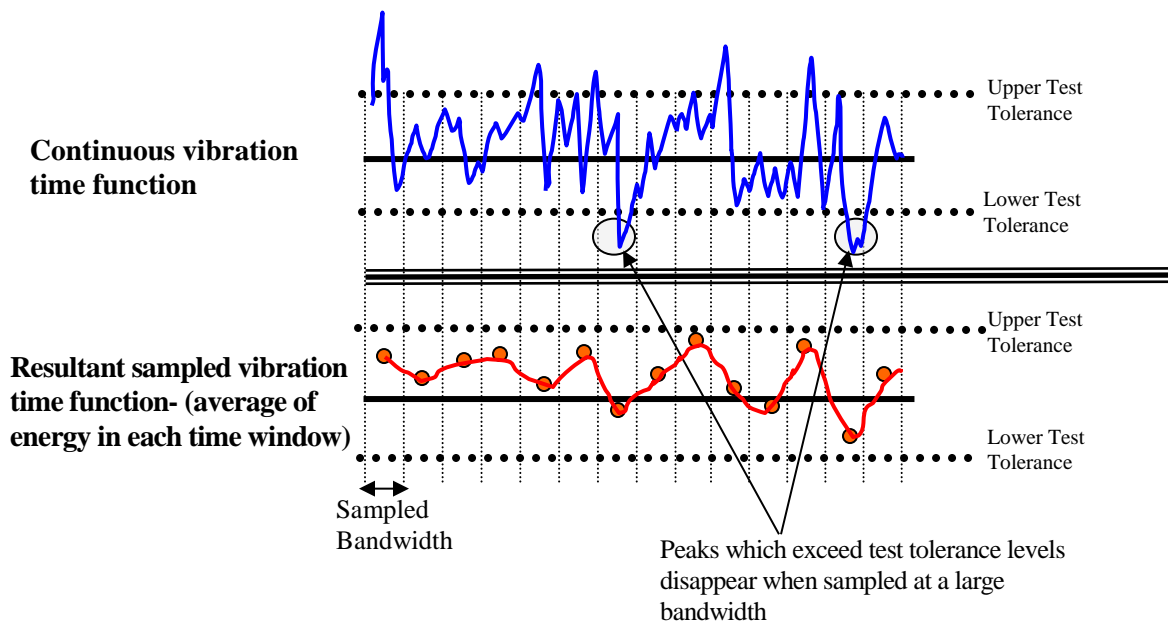

Figure B3.0-2. Effect of Bandwidth Sampling on Vibration Data



f. Test Configuration. Testing should reflect the flight configuration as much as possible. Of critical importance is the attaching hardware (flight connectors, cables, cable clamping scheme, attaching hardware such as vibration and shock isolators, brackets and bolts) which can be difficult to simulate in a flight configuration. Any deviations from the actual flight hardware configuration should be analyzed to ensure that all failure modes are being addressed. Another major concern involves acceptance testing. Often the acceptance test configuration does not reflect flight configuration. **Note:** Acceptance testing is typically not required to reflect flight configuration as long as the testing imparts an adequate workmanship screen. However, RTS hardware is demonstrated to be capable of withstanding acceptance test environmental stress screening through qualification testing. Changes in acceptance test configuration can impart new stresses that were not qualified under the qualification testing. For example, electrical cables used for acceptance testing are typically made to be more robust than flight cables (also used during qualification testing); this enables the same cable to be used over and over again for testing flight hardware. Unfortunately, the more robust test cable is often heavier

than the flight cable that results in flight hardware being overstressed. Not testing in a flight configuration is one of the most common areas of deficient testing.

B3.1 Certification Process (R) (A) (M) (S) (Q) (L)

B3.1.1 User Development Tests

User Development Tests validate hardware design concepts and assist in the evolution of designs from the conceptual phase to the operational phase. The objective of these tests is to identify hardware problems early in their design evolution, so any required actions can be taken prior to beginning formal qualification testing and production hardware fabrication. This testing is typically done prior to the start of Qualification Testing on the Design Verification/Qualification Units to ensure they are ready to proceed with environmental testing. Range Safety should be notified of significant component or system design changes dictated by development test.

B3.1.2 Qualification Tests.

General:

- (1) Qualification establishes a design baseline for environmental exposure limits. Once these limits are determined, then exposure of flight hardware can be verified to be below these limits. Qualification testing demonstrates that flight hardware will function within specification during flight and that acceptance testing will not damage flight hardware. This philosophy assumes that the production flight hardware utilizes the same parts, materials and processes as the qualification test unit. If this is not the case, other provisions should be made to ensure that each flight production unit would meet all required performance requirements during flight. For example, by controlling parts, materials and processes within a flight production lot, a sample of the lot could be subjected to qualification testing.
- (2) Since the number of qualification test samples required to demonstrate a high reliability would be significant (2994 units for a .999 at 95 percent confidence), the test philosophy described in this document recommends environmental test margins, functional performance testing and status-of-health tests which allow the number of test units to be drastically reduced. **Note:** Status-of-health tests are tests which may not directly related to the performance of the RTS component (e.g. TSPI) but are indicators that the component under test has experienced an internal anomaly.

B3.1.3 Acceptance Tests

Acceptance tests are performed to ensure flight survivability and to detect workmanship defects. The acceptance test level should be an envelop of flight environments and minimum workmanship screening levels. Workmanship testing (i.e. Environmental Stress Screening-ESS) is typically performed to a minimum vibration and thermal level. The intent is to screen for workmanship defects that could exhibit themselves as failures when exposed to flight

environments. To do this, it is important that critical functions be monitored and exercised during acceptance testing.

B3.1.4 Component Functional Verification

Since there can be a significant amount of time between acceptance testing and flight, a detailed functional checkout is needed to ensure there has been no degradation since the last test. Even though a system level functional test is a more desirable test, separate Component Functional Verification tests are usually necessary because it is difficult to provide an adequate functional test at the vehicle system-level. If the capability exists to perform an adequate RTS component functional test at the vehicle system-level, then a component-level test (i.e. bench test) may not be required. These system level tests include interfaces that input directly to the RTS (e.g. RF directional couplers) or system-level tests (e.g. through RF antenna hats).

B3.1.5 Pre-Flight Tests (R) (A) (M) (S) (Q) (L)

Preflight tests are performed after acceptance testing to verify that the RTS components meet safety performance requirements. These tests also ensure that components integrated into a vehicle system will meet all range safety performance requirements. These tests are typically performed at the launch range.

B3.1.5.1 Subsystem Tests

a. Final flight connections/assembly cannot usually be environmentally tested. VSWR and insertion loss testing has shown to be an excellent substitute in determining the integrity of the final flight configuration. Significant changes in VSWR can indicate a potential anomaly where a subsystem/system level test may not be sensitive enough to expose the same problem. A subsystem/system level test can demonstrate adequate performance in a static (nonenvironmental) condition. However, the ability to detect procedural or manufacturing defects that could degrade when exposed to flight environments is quite limited.

b. A GPS translator ground station along with an airborne translator shall be considered a system and validated using both sub-systems. This may include the use of the actual ground station hardware/software during acceptance, certification and qualification testing.

B3.1.5.2 System Test (R) (A) (M) (S) (Q) (L)

a. **GPS**

(1) N/C

(2) N/C

(3) It is anticipated that the testing outlined in this document will eliminate the need for compliance to this requirement. However, some systems that are not configuration controlled may require additional testing to ensure that any changes (known or unknown) will not affect critical range safety performance criteria.

(4) N/C

b. **IMU**

- (1) These checks use the best-available IMU/ guidance and control outputs and simulation techniques to verify readiness for flight. Inertial devices cannot undergo GPS-like dynamic testing in the pre-flight timeframe because it is impossible to inflict mission-level inertial environments prior to actual flight.
- (2) N/C
- (3) Regardless of the level of scrutiny placed on ground test procedures, it is difficult to guarantee that there are no IMU failure modes capable of producing undetectable false-position data, especially concerning gyro misalignment. Therefore, it is necessary to validate an IMU-based tracking system with another independent tracking system. For most vehicle applications, an initial validation shortly after lift-off with radar, GPS receiver or other non-IMU source is adequate to certify the IMU tracking source. For some ranges and vehicle applications, this validation could become a mission assurance impact. If the independent validating tracking source is unavailable, a tracking system based solely on an IMU may not be adequate and the vehicle mission would be put at risk. Allowing a vehicle to continue flight with an unvalidated IMU-based tracking system will generate some level of public safety risk. The amount of risk will be dependent on many factors such as an IMU history, trajectory, vehicle commodities, and proximity to the public, vehicle size and vehicle velocity. This risk should be quantified prior to the mission and mission rules should be set-up to address potential scenario where validating tracking sources are not available. Flying with unvalidated IMU-based tracking should be entered into with extreme caution. Additional analysis and ground testing should be implemented to mitigate concerns associated with undetectable false position data. For example, some precision IMUs can validate alignment through the Earth's rotation. Other mitigating factors include the history of the IMU-based tracking system; however, this type of supporting rationale can be difficult to employ. If the IMU parts, materials, processes or testing is altered in any way, this could invalidate its historical performance. In this case, configuration control would become a significant issue. IMU-based tracking should also be revalidated continuously through flight (if possible) and especially be analyzed after vehicle events such as staging. The shock generated from staging on some vehicles has created failures resulting in undetectable false-position data. These failures appear to be more prominent on mechanically gimballed systems; however, all IMU systems should be analyzed for susceptibility.

B3.1.6 Functional Tests

Functional tests are non-environmental electrical tests that demonstrate not only range safety performance criteria but also flight hardware status-of-health. **Note:** Status-of-health tests are tests which may not directly related to the performance of the RTS component (e.g. TSPI) but are indicators that the component under test has experienced an internal anomaly.

B3.1.7 Dynamic Simulations Tests

Validation of a range user's GPS dynamic simulator capability can be performed in numerous manners. One recommended approach is to take flight data from a GPS that flew in a

particular flight configuration and compare it to a dynamic simulation of the same flight configuration.

TEST 1: This test uses the actual flight vehicle configuration with the expected constellation at take-off to determine GPS tracking performance throughout flight. This test should be run with different lift-off times to ensure that the GPS will meet range safety performance criteria should the scheduled take-off time slip. Non-nominal vehicle RTS performance can be characterized by simulating worst-case vehicle maneuvers. The ability of the RTS to function can be determined and mission rules can be developed. Special emphasis shall be placed on RTS performance to ensure that real-time undetectable out-of-specification state vector data does not occur during nominal or non-nominal vehicle flight. It is probably too difficult to model complex vehicle failure modes such as tumbling; therefore, other tests shall show that undetectable out-of-specification tracking data can not occur under dynamically stressing conditions that exceed RTS specifications such as those described in Test 2 below.

TEST 2: Test 2 is intended to test the limits and health of the GPS component as follows:

- (1) Dynamic environmental threshold limits can be compared against vehicle dynamics to determine if the threshold limits envelop the worst-case vehicle dynamics (nominal, worst-case turn and breakup). **Note:** This analysis can be used to determine if track will likely be lost during non-nominal vehicle flight.
- (2) The effect of exceeding dynamic environment thresholds on the GPS performance. This test would ensure that the GPS does not produce false position data when exposed to extreme vehicle dynamics. **Note:** Producing false position data is acceptable given an error flag is available to notify the Flight Control Officer that the data may not be reliable in a real-time scenario.
- (3) Evaluate threshold performance parameters throughout different phases of launch processing and determine status-of-health. For example, the qualification test would run this standard simulation and develop a baseline. Subsequent flight units would then run the same test during vendor acceptance testing to ensure that the flight units were representative samples of the qualification unit. A bench test could be run close to launch, which again, uses the same standard simulation input. These values can be compared against acceptance test data to evaluate any potential degradation within the unit. Also, once enough data is collected, a database could be generated so that all flight units could be compared against expected values to determine out-of-family performance.

TEST 3: One of the problems encountered was to determine what functional testing could be performed during a typical 60-second vibration test. The concept developed was to input a fixed point in space into a flight unit and observe jitter during the vibration test. These variations in state vector are compared to the static (non-vibration) position. Flight hardware performance variations are compared to data obtained during qualification to determine if the flight unit is a representative sample of the qualification test unit. If the flight unit and qualification test unit are in-family, then it assumed that the flight unit will perform similarly to the qualification unit. **Note:** The qualification test units are subjected to this static state vector test during pre-qualification acceptance testing; then the qualification test unit is subjected to a

dynamic simulation performance test during qualification vibration. This association correlates a specific acceptance test state-vector variation with dynamic simulation performance test data obtained during qualification vibration.

TEST 4: This test was intended to be a rough order system-level test to ensure the GPS is functioning nominally prior to launch. Performing this test early in the vehicle processing flow (system pre-flight testing) is highly recommend to minimize concerns over last-minute anomalies. However, system pre-flight testing is considered mission assurance in most cases since take-off will most likely be cancelled if the GPS is not meeting its performance criteria prior to launch. An exception to this scenario is when take-off occurs before GPS acquisition occurs such as submarine, silo or canister launches. In these cases, it is strongly recommended that a system-level test be performed shortly before take-off.

ANALYSIS 1: This is a separate tool intended to supplement dynamic simulation performed using **TEST 1**. This analysis should be able to replace dynamic simulation tests (TEST 1) in demonstrating that a GPS will meet range safety performance criteria for different mission models. **Note:** TEST 1 should still be performed one time during qualification on a representative trajectory. Unlike dynamic simulation testing with hardware-in-the-loop, this analysis could be run real-time prior to launch to allow a mission to continue should a schedule delay occur or failure of a GPS satellite. It is hoped using analytical tools versus dynamic simulation hardware-in-the-loop testing will allow for reduced cost and high flexibility. In lieu of performing this analysis for each individual-unique mission scenario, it may also be possible to perform a one-time Monte-Carlo or other statistical analysis with the flight configured vehicle parameters to show that the required range safety performance requirements are always met, regardless of flight times, trajectories or unique vehicle hardware.

B3.1.8 Parallel Flight Tests (R) (A) (M) (S) (Q) (L)

Parallel flight tests may be required to identify unexpected problems that cannot be anticipated due to ground and airborne system complexity. Parallel flight tests should only be required for new technology RTS components (e.g. translator, an IMU or coupled IMU/GPS) that have not been already flight demonstrated. Using a flight-demonstrated RTS on different vehicle systems should not necessitate reperforming any parallel flight tests unless there is a unique vehicle application that invalidates the previous flight tests. Comparing parallel RTS flight data from one range to another should be assessed carefully since there are many Range-unique systems that could allow an RTS to perform adequately on one range but not another. For this reason, it is strongly recommended that each RTS technology have at least one flight off each applicable range to supplement parallel flight data used at other ranges. These tests are also recommended for mission assurance since many failure modes can lead to inadvertent termination of a nominal launch vehicle.

B3.1.9 Reuse Testing (R) (A) (M) (S) (Q) (L) N/C

B3.1.10 Special Tests (R) (A) (M) (S) (Q) (L) N/C

B3.1.11 Reference Functional Tests

Due to the short duration of some environmental tests, a subset of abbreviated critical tests is often necessary to obtain confidence in unit performance. Reference functional tests provide confidence that the unit under test will meet critical test criteria without having to increase test time to perform a full performance test. In addition to monitoring critical performance parameters, the use of status-of-health monitors during reference functional tests can be even more important. Status-of-health indicators will show anomalous behavior that may indicate a design/workmanship flaw. These flaws could degrade during flight environmental exposure and result in in-flight failures.

B3.2 Component Performance Verification Requirements (R) (A) (M) (S) (Q) (L)

The intent of these requirements is to demonstrate prelaunch and launch survivability. The detailed implementation procedures are at the range user's discretion; however, the detailed procedures should be reviewed to ensure they would meet the verification of the required performance parameters. Any commercial or military standard that has demonstrated itself to enable flight hardware performance may be used.

B3.2.1 Product Examination

These tests are intended to nondestructively ensure there are no physical anomalies not detectable by functional tests. These physical anomalies could degrade when exposed to flight environments and result in an in-flight failure.

B3.2.2 RESERVED

B3.2.3 RESERVED

B3.2.4 Non-Operating Environments

Each non-operating environment should be analyzed for the specific vehicle application. If the component is controlled such that it does not come in contact with a particular non-operating environment, then the test becomes not applicable. Great care should be exercised when attempting to control the environmental exposure of components. Discrepancies in the control process shall be examined to determine if there is a potential of inadvertently exposing flight hardware to untested environments. For example, to eliminate the concern for most non-operation environments, flight hardware can be stored and transported in a desiccated container then installed in an environmentally controlled vehicle. The controlling process (i.e. air conditioning) should be analyzed to determine the effect of a failure in the air conditioning system. In this case, the range user may opt to discard the suspect hardware as a contingency.

B3.2.5 Qualification Operating Environments N/C

B3.2.5.1 Sinusoidal Vibration

When converting random vibration to sinusoidal acceleration, great care must be exercised to ensure that adequate levels and time are placed on the component under test. Since random vibration is statistical (peak acceleration changes versus time at each frequency), a particular acceleration level will only occur a certain percentage of the time. Also, these peaks should occur in succession to ensure that any additive affects caused by resonant amplification are addressed. Most random vibration testing utilizes a normal distribution such that a 1σ level occurs 68 percent of the time, 2σ occurs 5 percent of the time and 3σ occurs 0.3 percent of the time. For example, in a 180 second vibration, a 10 Grms signal would experience a 30 Grms (3σ) for about half a second, which would not meet most programs' sinusoidal environmental requirements. In addition, at 2σ and 3σ values, the peaks will not very likely occur in succession. For this reason, 1σ should be the maximum value used for sinusoidal conversion. Going to lower sigma values can accumulate more time; however, this would decrease the acceleration level accordingly. For example a 2σ low value in the 10 Grms example above would lower the acceleration level to 5 Grms but increase the time to 171 seconds (95 percent of 180 seconds).

B3.2.5.2 Random Vibration

It is critical that a component be placed in its flight configuration during this test. Cable harnesses must tied down using their worst-case unsupported length. Mounting hardware used with the component must be included during these tests such as brackets, clamps and screws (with flight torque values). There have been numerous problems associated with test fixtures where they have amplified or attenuated the required environments to the component under test. As a result, control and response accelerometers must be placed as close to the component under test as possible. Response accelerometers should be located in two locations on opposite sides of the component to ensure the component is uniformly being subjected to the required test levels.

B3.2.5.3 Acoustic

For components contained within a confined structure, acoustic testing is usually enveloped by random vibration test levels (see paragraph B3.2.5.1). Acoustic testing is primarily required for antennas.

B3.2.5.4 Shock

Shock testing must duplicate the flight environment. Special care should be given to ensure the accelerometers are as close to the test article as possible. Accelerometers should not be too close to the shock-initiating source, as this may corrupt the accelerometer performance. The time domain should be analyzed to ensure a symmetric acceleration about the 0-G axis. Most shock events, such as pyroshock, can have significant G-forces at high frequencies. Although the displacements are low, it is still possible to damage rigid materials, which cannot tolerate displacement. For most applications, monitoring to 10Khz is adequate.

B3.2.5.5 Acceleration

See B3.2.5.1 for discussion on using random vibration if random vibration is to be used to envelop acceleration. Acceleration tends to result in more displacement unlike random vibration. Therefore, great care must be exercised when evaluating a component to determine if random vibration environments can be used to envelope acceleration levels. For example, a battery subjected to vibration testing would not produce the same effect as an acceleration test. In this case, during vibration of the battery may cause electrolyte splatter versus an acceleration test, which could drain the liquid out of the battery despite both tests having the same G-force levels. When evaluating a component, the subassembly and piece-parts must be analyzed to determine the amount of displacement that can occur during flight environments. For instance, a circuit board and connector will not move significantly but unsecured wiring within a component could have some displacement. Displacement should be analyzed by comparing component subassembly movement and random vibration displacement, the higher the frequency the smaller the displacement. Also, the frequencies up to the component resonant frequency will be in phase and additive; however, frequencies beyond the resonant frequency will be out-of-phase and should not be added together. Therefore, when using random vibration to envelop acceleration it is recommended to only integrate the vibration energy up to the component resonant frequency. For some components with high displacements subassemblies, individual parts can be subjected to an external push/pull test at levels that reflect the acceleration qualification test environment. In some cases, a push/pull test along with random vibration testing can meet the acceleration test criteria.

B3.2.5.6 Humidity N/C

B3.2.5.7 Thermal Cycle

Qualification test margins ensure that flight hardware is not overstressed during acceptance testing. Part of the qualification test margin assumes that the unit under test has already been subjected to acceptance testing. Therefore, it is critical in ensuring that any qualification test articles have first been subjected to acceptance testing.

B3.2.5.8 Thermal Vacuum (Temperature Altitude)

The first part of this test involves subjecting a component to a pressure gradient test, which reflects the flight trajectory. There is often a misconception that vacuum is the worst-case environment and that the pressure gradient test is not necessary, in that, if the component survives vacuum, it will survive any other pressure. Arcing and corona, the primary concerns, are mostly a function of the distance between electrodes, voltages, pressure and gas content. The relationship of these variables is described in graphs called Paschen curves. In general, the likelihood of arcing increases as pressure is decreased from sea level to a certain level, then as the pressure is further decreased the likelihood of arcing decreases once again. In addition to arcing, thermal vacuum also ensures the pressure integrity of sealed cavity devices to ensure they do not rupture at flight pressure. Analyses used in lieu of testing must address both of these environments.

B3.2.5.9 EMI/EMC N/C

B3.2.5.10 Temperature Shock N/C

B3.2.6 Acceptance Operating Environments N/C

B3.2.6.1 Random Vibration

There are two methodologies employed for acceptance random vibration. The first is for short duration missions with high vibration environments. For these missions, the vibration level is performed at flight levels or a minimum workmanship level whichever is greater. The concern for these types of missions is the high levels, not duration, which could be affected by workmanship defects. For extended duration mission (e.g. captive carry or Unmanned Aerial Vehicle flights), the levels are typically very low but require significant test time. Often, to maintain test time to a reasonable level, a fatigue equivalence analysis is used to allow an extended low vibration mission to be enveloped by a higher vibration shorter duration test. The fatigue equivalence formula can be found in MIL-STD-810. **Note:** The method used for acceptance must be consistent with qualification. The method chosen must be decided and agreed upon by Range Safety during the tailoring process.

B3.2.6.2 Acoustic

In general, acoustic testing is not used as a component workmanship screen. Random vibration is often adequate to perform workmanship screening.

B3.2.6.3 Acceleration

In general, acoustic testing is not used as a component workmanship screen. Random vibration is often adequate to perform workmanship screening.

B3.2.6.4 Thermal Cycle

There is a distinction between thermal acceptance testing of electronic and RF components. The major difference in these tests is that 18 thermal cycles are required versus eight, respectively. The 18 thermal cycles, in addition to providing a workmanship screen, also provide for burn-in of electronic piece-parts. Since passive RF components do not contain electronic piece-parts, eight thermal acceptance cycles is adequate for workmanship only. **Note:** If RF components contain active circuitry (i.e. components containing P/N junctions), then they should be tested as electronic components and subjected to 18 thermal cycles.

B3.2.6.5 Thermal Vacuum (Temperature Altitude)

Thermal vacuum acceptance testing is especially applicable to unsealed components using high voltages (greater than 50V). Many IMUs use higher voltage piece-parts, which can be susceptible to workmanship related arcing and corona. For low voltage or sealed components, thermal vacuum acceptance testing is often not performed.

B3.3.1 RF Acceptance and Qualification Tests N/C

B3.3.2 Global Positioning System Receiver Test Requirements N/C

B3.3.3 Global Positioning System Translator Test Requirements N/C

B3.3.4 RF Downlink Transmitter Test Requirements N/C

B3.3.5 Inertial Measurement Test Requirements N/C

B3.3.5.1 Accelerometer Test Requirements N/C

B3.3.5.1.1 Continuity and Isolation (R) N/C

B3.3.5.1.2 Input Current (R) N/C

B3.3.5.1.3 Accelerometer Warm-Up Time N/C

B3.3.5.1.4 Accelerometer Scale Factor and Bias

- i.* Scale Factor. Inertial instruments provide output signals proportional to rotation (gyro) or acceleration (accelerometer). Scale factor is the ratio between change in input and the associated change in output. Scale factor is measured for each inertial instrument during instrument-level acceptance/qualification testing and checked again during acceptance and qualification for the integrated inertial unit. Scale factor should remain within specification limits to assure an accurate estimate of position.
- ii.* Bias. Instrument reading when there is no input indicate instrument bias. This can be thought of as an instrument offset. The effect of accelerometer bias errors on position accuracy grow with time because the error is propagated over the entire mission. Bias is accordingly measured during instrument-level acceptance/qualification testing and checked again during acceptance and qualification of the integrated unit.

B3.3.5.1.5 Accelerometer Short and Long Term Stability N/C

B3.3.5.1.6 Accelerometer Repeatability N/C

B3.3.5.1.7 Accelerometer Sensitivity N/C

B3.3.5.1.8 Input Axis (IA)

Axis along which (accelerometer) or about which (gyro) an input causes maximum output. Misalignment of the instrument input axis with respect to the respective axis of the integrated inertial unit will cause loss of accuracy in the position estimate.

B3.3.5.1.9 Accelerometer Static Multipoint Test N/C

B3.3.5.1.10 Accelerometer Input Range

The range of accelerations that the accelerometer shall sense is listed in the unit specification. Input range testing verifies that the unit meets specification accuracy across the full range of required accelerations. For example, an instrument that could not properly sense and report high levels of acceleration would cause the integrated inertial unit to incorrectly report position. Input range tests are performed on centrifuges to accommodate the full range of accelerations.

B3.3.5.1.11 Accelerometer Precision Centrifuge Test N/C

B3.3.5.1.12 Hysteresis

Inertial instruments can demonstrate different outputs when the input is continuously increasing and decreasing. Accelerometer responses to both situations are plotted and the largest difference between the increasing versus decreasing traces is reported as the hysteresis error.

B3.3.5.1.13 Accelerometer Threshold

This is a state-of-health measurement to assure that the individual instrument meets requirements at the lowest specified level of acceleration. Inability to sense threshold acceleration would lead to errors in the position estimate.

B3.3.5.1.14 Leakage Test N/C

B3.3.5.1.15 Monitor Indicated Acceleration N/C

B3.3.5.2 Single-Axis Laser Gyro Test Requirements

B3.3.5.2.1 Continuity and Isolation (R) N/C

B3.3.5.2.2 Input Current (R) N/C

B3.3.5.2.3 Leakage Test N/C

B3.3.5.2.4 Turn-on time test N/C

B3.3.5.2.5 Warm-up Time Test N/C

B3.3.5.2.6 Temperature Sensor Characteristics N/C

B3.3.5.2.7 Operating Temperature Test N/C

B3.3.5.2.8 Gyro Scale Factor Test

a. Gyro Scale Factor

- Instrument reading when there is no input indicate instrument bias. This can be thought of as an instrument offset. Gyro bias errors also affect the position estimate accuracy as a function of time, translating into distance errors. Bias is accordingly measured during instrument-level acceptance/qualification testing and checked again during acceptance and qualification of the integrated unit.
- Input Axis (IA). Axis along which (accelerometer) or about which (gyro) an input causes maximum output. Misalignment of the instrument input axis with respect to the respective axis of the integrated inertial unit will cause loss of accuracy in the position estimate.

b. N/C

c. N/C

d. Scale Factor Nonlinearity

The scale factor may have second and higher order effects. Acceleration/rotation rate is accordingly tested in steps across the specified input range. This parameter is measured in instrument-level acceptance/qualification testing and checked again during acceptance and qualification testing for the integrated inertial unit. The least squares method is typically used to fit measured data to a straight line; residuals are plotted. Instrument quality can be specified by the standard deviation of residuals. Like the basic scale factor measurement, scale factor linearity can affect the accuracy of the position estimate: in this case as a function of the second and third order effects of acceleration and rotation.

B3.3.5.2.9 Gyro Input Rate

Since gyros sense rotation rates it is necessary to confirm specification level accuracy of the rate measurement across the full range of required rates. The measure of merit for this parameter is linearity of sensed rate input. If the gyro were to exhibit non-linear response to varying inputs, the accuracy of the position estimate would be affected.

B3.3.5.2.10 Anti-lock and Quantization Noise Test N/C

B3.3.5.2.11 Gyro Drift

Random drift is a key parameter for gyros. The unit is placed on a test condition that nulls out the effect of earth rotation and the instrument response is measured and recorded. Gyro drift is typically measured over the complete range of specified operating temperatures. If a gyro drifts during flight the instrument output will typically affect the accuracy of the position estimate.

B3.3.5.2.12 Input Alignment Characteristics N/C

B3.3.5.2.13 Generated Fields N/C

B3.3.5.2.14 Magnetic Leakage Test N/C

B3.3.5.2.15 Monitored Indicated Rate N/C

B3.3.5.3 Inertial Measurement Unit (IMU) Test Requirements

B3.3.5.3.1 Continuity and Isolation N/C

B3.3.5.3.2 DC Input voltage N/C

B3.3.5.3.3 Input Current N/C

B3.3.5.3.4 Navigation Functional Test

This test verifies performance of the navigation solution(s) in a static test mode. The focus of the test is to confirm that the unit under test produces the proper navigation solution. This may include an IMU in a stand-alone mode or the IMU may be coupled with a GPS. This test is typically used between operating environment tests to ensure that unit capability has not degraded as a result of each individual imposed environment.

B3.3.5.3.5 Sensor Performance Test

This is a one-time test that is done at the completion of qualification-level operational environments. It incorporates a tumble table to rotate the IMU through a series of reference positions. Tumble testing provides insight into instrument bias and scale factors and misalignments between the accelerometer and gyro triad sets. Intent is to compare detailed performance at the end of qualification to specification-level values and confirm that the unit meets all requirements. This is the final “end-of-the-line” test that assures that the unit has successfully survived maximum predicted environments.

B3.3.5.3.6 Monitor Navigation Solution and Velocity Errors N/C

B3.3.5.4 Coupled Inertial INS/GPS Test Requirements

B3.3.5.4.1 Continuity and Isolation N/C

B3.3.5.4.2 Input Current N/C

B3.3.5.4.3 Navigation Functional Test

This test verifies performance of the navigation solution(s) in a static test mode. The focus of the test is to confirm that the unit under test produces the proper navigation solution. This may include an IMU in a stand-alone mode or the IMU may be coupled with a GPS. This test is

typically used between operating environment tests to ensure that unit capability has not degraded as a result of each individual imposed environment.

B3.3.5.4.4 Sensor Performance Test

This is a one-time test that is done at the completion of qualification-level operational environments. It incorporates a tumble table to rotate the IMU through a series of reference positions. Tumble testing provides insight into instrument bias and scale factors and misalignments between the accelerometer and gyro triad sets. Intent is to compare detailed performance at the end of qualification to specification-level values and confirm that the unit meets all requirements. This is the final “end-of-the-line” test that assures that the unit has successfully survived maximum predicted environments.

B3.3.5.4.5 Monitor GPS, IMU, and Blended Navigation Solutions

B3.3.5.4.6 Monitor GPS Pseudo-Range and Pseudo-Range Rate N/C

B3.3.6.1 Sensitivity

Note: That acquisition sensitivity will differ by several dB from tracking threshold. Examples: An GTP may be able to track an acquired signal at 30 dB-Hz, but might require 37 dB-Hz to reacquire that same signal.

B3.3.6.2 Dynamic Range (R)

The input of the GTP must be able to reliably process the translated minimum and maximum power signals from liftoff to the end of flight. The values described throughout Appendix A represent current capability of existing GTPs.

B3.3.6.3 Reacquisition Test (R)

Reacquisition may be more difficult in a flight environment (velocity and acceleration). When a dropout occurs, the reacquisition time can be affected by how far the unit has moved since the signal was last processed.

B3.3.6.4 Receiver Autonomous Integrity Monitoring (R)(A) N/C

B3.3.6.5 De-selection of Faulty Satellites (R) (A) N/C

B4.1 RTS Analysis Requirements. (R) (Q) (A) (S) (L)

There are many processes to verify compliance to range safety critical performance requirements. In many cases, testing is not necessary and analyses that demonstrate that the component is not affected by the particular requirement are adequate to demonstrate compliance. Also, it is possible to eliminate certain analyses by demonstrating performance by testing. **Note:** Some performance requirements shall be validated by analysis. Each recommended solution in

Appendix A should be assessed to determine if an analysis is required to validate a required range safety performance parameter.

B4.2 RTS Failure Analysis (R) (Q) (A) (S) (L)

(1) Failure analyses should be performed on any component, subsystem or system-level failure to meet a critical performance or status-of-health requirement. The intent of a failure analyses is to demonstrate that no generic design or workmanship problems exist that could affect the flight performance of other components. Even for COTS models, failures that result in violation of range safety performance requirements must be evaluated to ensure there is no generic deficiency. Particular attention shall be given to failure modes that produce false position state vector data.

(2) Failure analyses should not only locate the failure, but should determine the root cause of the failure. If the root cause indicates a more generic concern, then new production units should incorporate corrective action to eliminate the problem. For production units already built, the range user should consider the following:

- a. Generate technical rationale describing why the potential defect will not result in a violation of any required performance requirement during flight.
- b. The failure is “screenable by test” and, therefore, any component with a suspect defect will be detected prior to flight.
- c. Generate a waiver describing the risks associated with using a “suspect” component that may violate required performance criteria. Acceptance of a waiver may require specific mission rules as a ground rule for acceptance such as additional tracking sources, limited trajectories, more stringent destruct criteria or visibility requirements.

B4.3 RTS Similarity Analyses (R) (Q) (A) (S) (L) N/C

B4.3.1 RTS Similarity Analyses (R) (Q) (A) (S) (L)

RTS components, subsystems and systems with no flight or test data often require significant test and analyses to demonstrate compliance with range safety required performance requirements. Vehicles utilizing RTS components with previous flight or test history can use this data to decrease or eliminate the need for additional tests and analyses to demonstrate performance requirements. The new application shall be analyzed to determine any differences from the previous use to ensure that there is no violation of a performance requirement. These differences may still require testing or analysis, but a reduced level.

B4.3.2 Piece-Part Similarity Analysis

Often as components are manufactured throughout their production lifetime, piece-parts become unavailable for many reasons; therefore, substitute parts shall be found. Also, design deficiencies, product improvement or parts substitutions may require the addition or subtraction of piece-parts. Substitution or addition of piece-parts into a flight unit can introduce performance and environmental survivability discrepancies. Even though an analysis can be used in some cases, components that undergo a parts addition, subtraction and substitution

should be subjected to some level of electrical functional requalification testing to demonstrate that component performance has not changed. Environmental survivability is often more difficult to demonstrate as described below:

- a. Components with substitute piece-parts typically undergo an analysis to show that the same part has flown in another component that has been subjected to the same or greater environment. **Note:** It is sometimes difficult to determine the environment the piece-part undergoes in its mounting location (i.e. piece-part environment versus box-level environment).
- b. Components that have undergone piece-part addition or removal should be specifically analyzed to determine environmental survivability. Often some level of requalification testing can only validate the environmental survivability of a component with added piece-parts. The extent of testing, if required, depends on the mass properties and mounting configuration of the new part.
- c. For components not under configuration control, the requirements of this section are subject to the conditions of paragraphs 2.1.1, A2.1.1 and B2.1.1

B4.4 RTS Reliability Analysis (R) N/C

B4.5 RTS Energy/Power Analysis (R) N/C

B4.6 RTS RF Link Analysis (R)

In general, TM downlink (including antenna patterns) is needed by the range to determine what TM receiving assets should be available for the intended mission. This data also helps determine the times that each TM receiving station will be effective and whether supplemental support is needed to meet range safety requirements. Analysis of the L-band GPS link shall be performed by the range user to ensure adequate GPS coverage. **Note:** A dynamic simulation can take the place of this analysis.

- a. The GPS shall be shown to demonstrate that it will meet all range safety performance criteria during nominal flight.
- b. Anomalous trajectories should be analyzed to determine if a GPS lock will be lost and/or the GPS source could produce false position data.
- c. RCC 253 is a recommended source for antenna patterns since most ranges are compatible with this data format. Range users with different formats may have to provide funding for range modifications to allow compatibility to the new data format.
- d. Radiated TM downlink energy is high power. The center frequency, as well as, harmonics and IF emissions should be analyzed to ensure that the TM downlink does not affect other launch vehicle systems.
- e. This analysis is different from the dynamic simulation, although a dynamic simulation could also be used. This analysis would use a computer to simulate the launch vehicle orientation and a GPS antenna characteristics rather than actually using a GPS hardware and a satellite simulator. This analysis should be easier to perform in real-time at the launch facility when compared to a dynamic simulation since it is only concerned for ensuring satellite geometry (DOP). The analysis should demonstrate that range safety performance requirements

are met by utilizing vehicle trajectory with antenna patterns to determine the DOP throughout the entire mission. This analysis is intended to give the range user more flexibility to account for launch schedule changes and to ensure that range safety performance criteria are met with the new launch criteria. In lieu of using vehicle antenna patterns in this simulation, a cone radiating from the perpendicular axis of the antenna can be generated, in which, any GPS satellite within the cone will be assumed to be an adequate source. This cone angle can be generated by performing a link budget analysis to guarantee a minimum C/N_0 is available at the GPS processor within that given cone angle (using the antenna pattern data).

B4.7 Re-Use N/C

B4.8 Prior Flight History

Prior flight history can be used as technical rationale to reduce/eliminate design, test or performance requirements. To be effective, the prior flight application shall be analyzed to determine if it is applicable to the new configuration. Any deficiencies require specific evaluation to determine if additional analysis or testing is required.

B4.9 RTS RF Environment Analysis (R) N/C

B4.10 Breakup Analysis (R) (A)

a. A vehicle breakup analysis is to determine where and when the RTS is most likely to fail under credible failure scenarios. **Note:** These analyses are usually required for the FTS.

b(1). The main emphasis of this analysis should be the quality of state vectors provided during failure conditions leading up to break-up. The results of this analysis can be used as an input into dynamic simulation testing.

b(2). Though tracking during non-nominal vehicle flight is highly desirable, it primarily a mission assurance item. However, there may be applications that could affect public safety and must be evaluated on a case-by-case basis. Vehicle jerks are transitory and would not be expected to be included in this analysis.

B4.11 Dynamic Simulation Analysis (R)(A) N/C

B4.12 Independence Analysis (R) (I) (M) (A) (S) (L) (Q)

Of particular concern would be failures in one tracking source that affect the performance of another required tracking source. The independence analysis is critical for systems such as coupled GPS/INS, fault tolerant TMIG or other RTS sources that couple multiple tracking sources. For dual phenomenology (two different technologies such as uncoupled TMIG and GPS), this analysis is most likely not required. Without any information, these failure modes create scenarios that require real-time decisions that may involve termination of flight. If the potential failure modes are known during pre-mission planning, they can be evaluated and mission rules can be determined prior to launch. If these mission rules were unacceptable to a range user, further efforts could be initiated to develop corrective action or mitigating factors to develop a more favorable mission rule.

B4.13 Failure Modes and Effects Criticality Analysis (FMECA) (R) (I) (M) (A) (S) (L) (Q)

This analysis provides confidence that an RTS tracking source will provide the required performance data. The intent of this analysis is to show that either the tracking performance data is acceptable or no data will be available. **Note:** Single failures that result in loss of tracking data for a single RTS component are acceptable; the concern is for real-time undetectable single failures that produce out-of-specification tracking data. Undetectable out-of-specification performance is a safety concern since the RSO could be unaware of a non-nominal vehicle, which could result in violation of public safety risk criteria. This concern is also described in B2.1.4.

B5.0 Documentation Requirements (Q) (R) N/C

APPENDIX C

TEST METHODS FOR GPS DYNAMIC SIMULATION TESTING

C1.0 Introduction

This appendix provides the methodology for testing GPS metric tracking receivers/translators to the current performance standards contained herein. These test methodologies are intended to aid the user in performing the dynamic simulation test (Test 2) described in Appendix A3.1.7.

C1.1 Scope

The test methodologies included here apply to all GPS receivers/translators used for range safety purposes where the requirements for dynamic simulation testing have been levied. All test performance requirements identified in Chapter 3 and Appendix A, including failure reporting, test equipment, and test conditions, shall be adhered to.

C2.0 Dynamic Simulation Testing

C2.1 Overview

An important aspect of testing GPS receiver and translator instrumentation used for range safety is the demonstration of adequate metric tracking performance to meet the performance requirements identified in Chapter 3 and Appendix A. Such testing may be greatly facilitated using simulators designed to synthesize realistic GPS RF signals for input into GPS equipment undergoing tests. The simulators envisioned here have the capability to simulate RF signals based on flexible control parameters specifying the GPS constellation, flight vehicle dynamics, vehicle antenna characteristics, atmospheric propagation effects, and signal-to-noise ratios.

The essence of testing scenarios can best be described by an example of top level end-to-end performance testing in conjunction with planning a hypothetical mission. Individual steps would be to:

- a. Configure the GPS simulator to represent the constellation during the planned time interval of launch.
 - (1) Define signal strengths and associated clock and ephemeris errors of constellation satellites.
 - (2) Set ionospheric and tropospheric propagation delay parameters.
- b. Define, in a specified reference frame, the complete six degrees of freedom (6DOF) dynamic trajectory of the launch vehicle, which is input to the GPS simulator at a sufficiently high sample rate to ensure simulation fidelity.
- c. Specify vehicle antenna characteristics in terms of the position of the antenna phase center, within the vehicle frame, and the associated gain and phase patterns (including blockage effects) in spherical form relative to vehicle orientation. Other parameters

need to be adjusted as appropriate to achieve desired signal-to-noise ratio characteristics.

- d. Configure the GPS equipment under test to accept the simulator RF output. The equipment will consist of either a GPS translator or receiver, together with associated signal and data processing subsystems capable of producing a vehicle state vector. At the least, the state vector elements consist of vehicle position and velocity coordinates in a specified Cartesian frame, and possibly other parameters of interest as well. Examples of the other parameters include time and frequency offsets within the GPS processing equipment. The state vector position and velocity elements are also called the navigation state vector.
- e. Form differences of navigation state vector components, output by the GPS equipment under test, with simulator inputs to produce a time series of errors in trajectory space. The need also exists to propagate the time series of navigation errors into impact space in order to produce a time series of instantaneous impact prediction (IIP) errors.
- f. Compare trajectory and IIP errors with established flight safety requirements to evaluate performance acceptability of GPS equipment under test, noting in particular any anomalies, which may have occurred during the test.

This simple example illustrates the minimum test objectives for GPS equipment used for flight safety.

C2.2 Background

In addition to overall trajectory and IIP accuracy during a nominal mission, other aspects of performance are also of interest. These include the:

- a. Time-to-first fix.
- b. Carrier-to-noise ratio thresholds.
- c. Responsiveness to sudden shifts in acceleration and jerk.
- d. Ability to track sustained high levels of acceleration and jerk,
- e. Track acquisition/ reacquisition delays, timing accuracy, and latency
- f. Ability to sustain state vector accuracy under errant vehicle conditions at critical moments in the flight profile.

Successful test design relies on a certain level of knowledge of both GPS simulator and GPS equipment characteristics. Global Positioning System (GPS) tracking of high dynamic vehicles requires signal processors operating at rates as high as 40 megabits per second. Tracking loops within GPS equipment routinely operate at sample rates as high as one kilohertz. In order for the GPS simulator to produce realistic RF signals, it must faithfully characterize vehicle dynamics at sample rates as high as one kilohertz. If the reference trajectory sample rate is less than one kilohertz, great care must be exercised to ensure that interpolation errors are sufficiently small as to create no anomalies in the RF signals which could produce discernible track performance degradation within the GPS equipment under test.

Although individual GPS systems may operate somewhat differently when examined in detail, certain aspects of GPS tracking are generic in nature. Basically, each GPS system has a certain number of independent tracking channels, each of which may be used to track a single code and carrier pair of any single GPS satellite. The code is either C/A or P[Y], and the carrier is L1 or L2, although this will change in the future, when other GPS codes and carrier frequencies are augmented. Superimposed on each GPS signal is the navigation message at 50 bits per second. The message from each satellite contains ephemeris and clock data for the respective satellite, as well as almanac data for the constellation as a whole.

The function of a single GPS tracking channel is central to understanding GPS processor operation. In the search mode, a given channel attempts to complete a sequence consisting of detection, acquisition, and track for a single GPS signal from a specific satellite. Upon detection, the channel enters a mode in which the carrier and code are weakly tracked, prior to achieving complete carrier and code lock status. The weak tracking or frequency lock (FL) mode is characterized by bounded frequency and code tracking errors, accompanied by a considerable degree of carrier cycle slippage. Once carrier cycle slippage is halted, a phase lock (PL) or strong tracking mode is achieved. The outputs of the tracking channel in the PL mode consist of measurements of pseudorange (PR) and delta pseudorange (DPR), respectively, based on code and carrier track. In the PL mode, nominal measurement accuracies are expected; in the FL mode, accuracy is degraded and the measurements may be rejected for state vector processing purposes.

When either relatively high dynamics or low carrier-to-noise ratios are encountered, any channel may degrade from PL to FL mode and subsequently lose track altogether. In this case the channel may enter a reacquisition mode in an attempt to regain PL mode tracking.

The design of GPS trackers to generate PR and DPR measurements involves a fundamental trade between dynamic and noise performance. The design typically involves code tracking to recover PR and carrier tracking to recover DPR. Trackers are characterized mainly by their respective noise bandwidths, and under optimal design conditions, dynamic performance improves with increasing bandwidth, while noise performance improves with decreasing bandwidth. In actual tracking systems however, the design is not necessarily optimal, and noise and dynamic performance measures must be independently tested and verified.

The design of GPS trackers in high dynamic applications usually strives for the capability to sustain continuous code and carrier lock under conditions of abrupt, discrete acceleration changes connected by intervals over which the jerk is constant. Typically code tracking is aided by carrier tracking, and the carrier tracking function poses the critical issue in GPS tracker design.

Overall GPS operation involves a sequence consisting of initial acquisition of GPS signals, ephemeris and almanac data collection, establishing track on four or more GPS satellites to obtain a first fix, continued tracking of GPS satellites, with occasional track channel switching of satellites, continuous filtering of PR and DPR measurements to obtain a navigation state vector, occasional loss of track from individual satellites, and subsequent reacquisition of the same or alternate satellites. Occasionally events occur which may cause a momentary loss of

track on all satellites. Depending on the duration of track loss, reacquisition procedures may engage and some amount of time may elapse before the tracking and navigation functions resettle.

In preparing for actual GPS equipment testing, the peculiar features of the equipment under test may be known and utilized to advantage in designing specific tests. The basic objectives of testing involve verification and validation methods to compare performance vis-à-vis GPS equipment specifications and flight safety requirements.

C2.3 Preparation for Testing

A variety of considerations are important in preparation for GPS equipment testing. Broadly these considerations may be grouped in three categories: Scenario, Simulator, and GPS Equipment under Test.

C2.3.1 Scenario. The attributes of the scenario include the trajectory or motion of the vehicle carrying the GPS sensor equipment, the state of the GPS satellite constellation to be simulated for the test, visibility conditions resulting from antenna gain (and blockage) and restrictions imposed by elevation mask angles, along with other satellite selection criteria. These factors are sufficient to compute the gross performance measure known as GDOP, which varies with time during the scenario.

It is worthwhile to prepare a very useful type of polar coordinate graph for the entire scenario. This graph is described in the following sentences. The GPS sensor-bearing vehicle is at the origin (pole) of the graph throughout the scenario, and the track segment of each GPS constellation satellite - which is a candidate for tracking at any time during the scenario - is plotted for the entire scenario. The polar angle coordinate to each track segment (one per satellite) represents the azimuth angle, in the local level frame moving with the vehicle, to the respective satellite. The polar range coordinate to each track segment represents the elevation angle, in the local level frame attached to the vehicle, measured from the vehicle to the respective satellite. The azimuth angle varies from 0 to 360 degrees on the polar plot. At the pole of the graph, the elevation angle is 90 degrees. Around the circular edge of the graph, the elevation angle is the minimum feasible value for GPS sensor track (which may be negative for high altitude vehicles). The parameter used to plot the track segment of each GPS satellite is scenario time. Portions of each satellite track segment which are not feasible for GPS tracking may be plotted as dashed curves.

Another useful set of graphs consists of plots for each GPS constellation satellite, of the range, range rate, range acceleration, and range jerk, produced by the relative motion of the GPS sensor-bearing vehicle and the respective GPS constellation satellite, over the duration of the scenario.

A plot of predicted C/No for each visible satellite over the duration of the scenario is also useful. The predicted C/No is a function of satellite and vehicle positions, vehicle orientation, antenna gain (modulated by blockage and masking), atmospheric attenuation, background noise and receiver noise parameters.

C2.3.2 Simulator. A top-level checklist of simulator considerations includes:

- a. How many separate vehicles and antennas can be simulated in each scenario?
- b. What is the required input form for 6DOF trajectory variables?
- c. What is the maximum trajectory input sample rate, and how is that data interpolated to higher rates internal to the simulator?
- d. What is the form and resolution of antenna gain and phase?
- e. How is C/No controlled/verified?
- f. How are atmospheric attenuation and delay controlled for the troposphere and ionosphere?
- g. How are the constellation errors (e.g., clock and ephemeris) controlled?
- h. Does the simulator produce C/A and P[Y] codes as well as L1 and L2 carriers?
- i. What are the parametric attributes of the simulator RF output(s)?

C2.3.3 GPS Equipment under Test. A top-level checklist for the equipment under test includes:

- a. Determine how to initialize and operate the GPS equipment for each test scenario.
- b. Determine the proper antenna characteristics to be input to the Simulator.
- c. Determine the parameters to be recorded from the GPS equipment during test.
- d. Understand the GPS equipment modes, operational basics, and functional characteristics.
- e. Understand both theoretical and specified performance limits of the GPS equipment.
- f. Understand methods and options for ionospheric and tropospheric delay compensation.
- j. Understand the control loop parameters for each type of track (code/carrier) including noise bandwidths.
- h. Understand all diagnostic and performance related outputs available from the GPS equipment.

C2.4 Testing Categories

The types of tests to be conducted can broadly be divided into those which involve specific operational scenarios and their perturbations, and those which are performed independent of any particular scenario and which are devised to test certain specific aspects of GPS equipment dynamic and/or noise performance. An example of the former category was given in the overview at paragraph C2.1, and such tests are based on as much realism with respect to operational scenarios as deemed warranted by the Test Director. In the latter category, it is most important to design tests which can be conveniently conducted to achieve specific test objectives with respect to isolated performance measures.

In the category of specific dynamic test objectives, it is convenient to isolate and control the dynamics presented to each channel individually. There are multitudinous ways in which this can be accomplished, but discussion of a single example illustrates the main points of test design. The first objective is to arrange for the vehicle dynamics to appear predominantly in a single selected tracking channel, which itself is assigned to a specific satellite. The vehicle

dynamics are then directed entirely in the vertical direction from a specified launch point on the earth surface. The launch point is selected such that it lies on the ground track of a selected GPS satellite, and the launch time is selected such that the dynamic test interval is symmetric with respect to the time at which the selected satellite is directly above the launch point. Then to a satisfactory approximation, the vehicle dynamics are aligned with the range coordinate from vehicle to satellite over short duration test intervals. This scenario facilitates test design, and the actual dynamics in the tracking channel assigned to the selected satellite will approximate the input vertical dynamics of the vehicle. (However, it is assumed that the exact dynamics in the tracking channel will be computed and used as the reference for test data analysis.)

In the category of specific noise performance test objectives, it is convenient to have a simple, direct method for controlling carrier-to-noise ratio in each tracking channel. One such method is described herein. For basic noise performance testing, assume the vehicle remains at rest at a launch point on the earth surface throughout the test, with vehicle orientation such that the antenna pattern can be specified easily in terms of azimuth and elevation angles at the launch point. The antenna gain will be made to vary only with elevation angle, and the antenna phase is set to zero in all directions. By appropriately selecting the antenna gain to vary smoothly in a monotone increasing manner with increasing elevation angle, the carrier-to-noise ratio becomes solely a function of satellite elevation angle in all tracking channels. Moreover with a normal GPS constellation, the elevation angles - which vary from a minimum to a maximum back to a minimum - may be noted when acquisition, track, and loss of track events occur, and subsequently used to infer the corresponding carrier-to-noise ratios. Furthermore, in the intervening tracking intervals, measurement error statistics may be computed and related to carrier-to-noise ratio via the corresponding elevation angles.

C2.5 Specialized Test Scenarios

C2.5.1 High Dynamic Rocket Stage. In this example, a single stage rocket is launched with a particular GPS satellite located directly over the launch pad midway through the scenario. At launch time the vertical acceleration abruptly jumps to a large positive value. During the interval in which the stage burns, a large, constant, positive, vertical jerk is maintained. At burnout, the thrust acceleration abruptly returns to zero, and vehicle free fall motion commences for a short interval beyond burnout in order to allow GPS tracking to settle.

The dynamic parameters in this scenario can be set to test the ability of GPS tracking channels to track through abrupt acceleration shifts and sustained high levels of jerk.

The dynamic performance of this scenario also can be characterized with carrier-to-noise ratio as a parameter. To accomplish this we examine tracking in the channel assigned to the satellite directly above the launch point. The scenario is then repeated as many times as desired with different carrier-to-noise ratios. For each repetition, the antenna gain within TBD degrees of the vertical is reset to specific values in order to achieve the desired carrier-to-noise ratios.

C2.5.2 Sawtooth Dynamics Tests. In these tests, a sawtooth waveform defines the vehicle dynamics. The sawtooth waveforms are characterized by abrupt acceleration shifts at discrete time points, with continuous acceleration and constant jerk in the subintervals between the discrete time points. A typical scenario places one GPS satellite directly over the launch point midway through the test interval, and orients all vehicle motion in the vertical direction at the launch point. In this manner the dynamics presented to the channel assigned to the overhead satellite are readily identifiable and easily controlled. These tests are particularly useful for subjecting GPS tracking to rapidly changing dynamics, wherein the spacing between points of abrupt acceleration shifts is just sufficient to allow the GPS tracking function to momentarily settle on each subinterval.

C2.6 Test Observables

C2.6.1 Trajectory Errors. The position and velocity state vector errors constitute the fundamental GPS navigation error. The error is computed by differencing corresponding components of the GPS simulator input trajectory in time alignment with the GPS equipment state vector to produce a time series of component errors. The coordinate system utilized is typically that of an earth-centered, Cartesian frame. Note that precision time alignment can be accomplished utilizing the clock bias state from the GPS tracking filter; this step should be necessary only when the magnitude of the clock bias state is abnormally large.)

C2.6.2 IIP Errors. An auxiliary time series of crossrange and downrange IIP errors is obtained by mapping the trajectory errors into IIP space, utilizing time varying, trajectory-dependent linear mappings in the form of 2x6 matrices.

C2.6.3 PR Residuals. The PR outputs of each tracking channel are used to compute the time series of these residuals by subtracting the true time aligned range from the measured PR in each channel. In addition to dynamic and noise induced tracker errors, these residuals will also contain errors due to satellite navigation message data, satellite and receiver clocks, channel biases, and atmospheric delays.

C2.6.4 DPR Residuals. The DPR measurements are computed from the total accumulated phase shift output from the carrier tracking loop in each channel. Over each interval wherein PL mode tracking is sustained without cycle slips, the DPR measurements are continuous in a discrete sense, and tend to contain far less noise than the PR measurements. This makes the DPR residuals – which are computed analogously to the PR residuals – especially useful for diagnostic analyses of tracker performance.

C2.6.5 DPRDOT Residuals. In realtime flight safety applications, the accuracy and timeliness of velocity components in the state vector are of utmost interest. Because of the excellent precision of the DPR measurements, they are amenable to differencing over very short intervals as a means of obtaining DPRDOT measurements of high precision with only slight latency. Typically these intervals are of 0.1 second duration for flight safety applications. The realtime tracking filter converts DPRDOT measurements into estimates of Cartesian velocity components and clock frequency error in analogous fashion to that which converts PR measurements into estimates of Cartesian position components and clock time error. Direct input of DPR measurements into the

tracking filter, while theoretically optimal, is not usually done in realtime applications because the effects of covert cycle slips can devastate filter performance. The DPRDOT measurements, differenced with true time-aligned range rate in each channel respectively, yield the DPRDOT residual time series observables.

C2.7 Data Analysis

The objectives of the data analysis phase in GPS equipment tests involve not only performance evaluations, but diagnostic evaluations as well for the inevitable anomalies which will generally occur at one or more junctures in the course of testing. For these purposes, the test observables defined above may be invaluable, but should be augmented with particular diagnostic aids provided directly by the GPS equipment under test. For example, the equipment itself may provide indicators of track mode or status, as well as internal estimates of carrier-to-noise ratio in each active channel.

The state vector errors are indicative of whether the GPS equipment under test is functioning properly, and the individual PR and DPR residuals of respective channels are indicative of the tracking quality within each channel.

The DPR residuals are relatively quite smooth and also most sensitive to the presence of tracking anomalies within any given channel. Generally, isolated cycle slips are immediately apparent in the corresponding DPR residuals. Also the first indication of transition into and out of the desired PL mode is generally found in the corresponding DPR residual time series.

In order to isolate dynamic and noise induced tracker errors, it is best if the specialized test scenarios are performed with satellite and atmospheric errors set to zero in the simulator. However, the receiver channel bias and clock errors effects cannot be set to zero in the equipment under test; they only can be estimated. The navigation filter estimate of receiver clock error, which is common to residuals in all channels, can be useful in compensating the residuals. But this process introduces filter estimation error into these residuals, and should never be performed on the relatively low noise DPR residuals or on PR residuals when used for computation of noise error statistics.

C2.7.1 GPS Response to Acceleration Shift. Typically, when an abrupt shift in acceleration occurs, GPS tracking equipment undergoes a transient response before settling. If the acceleration discontinuity is small, the transient response is evident in the time series of residuals. As the magnitude of discontinuity is increased, a point will be reached when cycle slipping begins to occur. Still larger magnitudes of acceleration discontinuity will result in transition from PL mode to FL mode and, ultimately, loss of track. In the latter event the tracker will enter a reacquisition mode, and if possible, restore PL mode tracking after some delay. Specialized tests, wherein the magnitude of acceleration discontinuity is a test parameter, are useful to identify intermediate thresholds between commencement of cycle slipping and complete loss of track. The resulting duration of the reacquisition interval between loss of track and PL mode recovery is an important performance measure in such tests. Also, the maximum sustained acceleration tracking capability of the GPS equipment under test can be established by these tests.

C2.7.2 GPS Response to Sustained Jerk. Typically, GPS tracking equipment will exhibit a tracking error proportional to jerk in the range coordinate of each channel. But as in the acceleration case, if the jerk magnitude is steadily increased, cycle slipping and ultimately loss of track will occur. Specialized tests, wherein the magnitude of sustained jerk is a test parameter, are useful in characterizing track error response to jerk and measuring appropriate proportionality relationships, as well as to identify intermediate thresholds between commencement of cycle slipping and complete loss of track.

C2.7.3 GPS Errors versus C/No. The capability of GPS equipment to acquire and maintain track is strongly dependent on the carrier-to-noise power density ratio, usually denoted by C/No and expressed in units of dB-Hz. Performance measures of interest include: the minimum C/No required to acquire track, the minimum C/No required to sustain track, and the relationship of measurement noise statistics to C/No. Specialized tests, wherein C/No is treated as a test parameter, are useful to identify intermediate acquisition and tracking thresholds and characterize measurement noise error statistics using the time series of residuals.

******* NOTHING FOLLOWS *******