

TELEMETRY STANDARDS

**TELEMETRY GROUP
INTER-RANGE INSTRUMENTATION GROUP
RANGE COMMANDERS COUNCIL**

**KWAJALEIN MISSILE RANGE
WHITE SANDS MISSILE RANGE
YUMA PROVING GROUND**

**NAVAL WEAPONS CENTER
PACIFIC MISSILE TEST CENTER
ATLANTIC FLEET WEAPONS TRAINING FACILITY
NAVAL AIR TEST CENTER**

**AIR FORCE EASTERN TEST RANGE
AIR FORCE FLIGHT TEST CENTER
AIR FORCE SATELLITE CONTROL FACILITY
SPACE AND MISSILE TEST CENTER
ARMAMENT DEVELOPMENT AND TEST CENTER
AIR FORCE TACTICAL FIGHTER WEAPONS CENTER**

DOCUMENT 106-73

TELEMETRY STANDARDS
Revised November 1975

Containing International (SI) Units
and Conventional Units

TELEMETRY GROUP
INTER-RANGE INSTRUMENTATION GROUP
RANGE COMMANDERS COUNCIL

Published by

Secretariat
Range Commanders Council
White Sands Missile Range,
New Mexico 88002

APPROVED FOR PUBLIC RELEASE; DISTRIBUTION UNLIMITED

CONTENTS

	PAGE
Footnotes	x
Chapter 1 – Introduction	1
Section I General	1
1-1 General	1
1-2 Scope	1
1-3 Purpose	1
1-4 Reference Documents	1
1-5 Definitions	1
1-6 General Statements or Requirements	2
Section II Detailed Requirements	2
1-7 Frequency Parameters and Criteria of Telemetry Transmitter and Receiver Systems	2
1-8 Frequency Band 225 to 260 MHz	2
Chapter 2 – Transmitter and Receiver Systems	3
Section I 225 to 260 MHz Frequency Band	3
2-1 Transmitter Systems	3
2-2 Receiver Systems	4
Section II 1435-1535 and 2200-2300 MHz Frequency Bands	4
2-3 Band Spacing	4
2-4 Allocation of 1435-1535 MHz Band	4
2-5 Allocation of the 2200-2300 MHz Band	5
2-6 Transmitter Systems	5
2-7 Receiver Systems	6
Chapter 3 – Frequency Division Multiplexing Telemetry Standards	7
Section I Introduction	7
3-1 General	7
3-2 Scope	7

REVISED NOVEMBER 1975

CONTENTS (Cont'd)

	PAGE
Section II - FM Subcarriers	7
3-3 Characteristics	7
3-4 FM Subcarrier Channel Characteristics	7
3-5 Tape Speed Control & Flutter Compensation	9
Section III - AM Subcarriers (Deleted, see note)	9
CHAPTER 4 - Pulse Code Modulation (PCM) Standards	15
Section I - Introduction	15
4-1 General	15
Section II - Description and Data	15
4-2 Word and Frame Structure	15
4-3 Bit Rate	17
4-4 Multiple and Submultiple Sampling	18A
4-5 Radio Frequency and Subcarrier Modulation	18B
4-6 Premodulation Filtering	18B
Chapter 5 - Pulse Amplitude Modulation (PAM) Standard	19
Section I - Introduction	19
5-1 General	19
Section II - Description and Data	19
5-2 Frame and Pulse Structure	19
5-3 Frame and Pulse Rate	21
5-4 Multiple and Submultiple Sampling Rates	21
5-5 Frequency Modulation	22
5-6 Premodulation Filtering	22
Chapter 6 - Pulse Duration Modulation (PDM) Standard (Deleted, see note)	(23-26)

CONTENTS (Cont'd)

	PAGE
Chapter 7 – Magnetic Tape Recorder/Reproducer Standards	27
Section I - Introduction	27
7-1 General	27
Section II - Compatibility Requirements	27
7-2 Fixed Head Recorder/Reproducer	27
7-3 Direct Recording	28
7-4 Single Carrier FM Record and Wideband FM Record System	35
7-5 PCM Recording	38
7-6 Tape	38
7-7 Parallel PCM	38
7-8 PDM Recording (Deleted, see note)	44
7-9 Record Amplifier (Deleted, see note)	44
7-10 Reproduce Amplifier (Deleted, see note)	44
Chapter 8 – Magnetic Tape Standards	47
Section I - Introduction	47
8-1 General	47
Section II - Reference Tape System	47
8-2 Purpose	47
8-3 Manufacturer's Centerline Tape	47
8-4 Manufacturer's Secondary Centerline Tape	47
8-5 Centerline Performance Requirements	48
8-6 MCT/MSCT Use	48
8-7 Test Recorder/Reproducer	48
8-8 Test Recorder/Reproducer Requirements	48
8-9 General Requirements	48
8-10 Detailed Requirements	51
8-11 General Characteristics	51
8-12 Physical Characteristics	52
8-13 Magnetic/Electrical Characteristics	54

REVISED NOVEMBER 1975

APPENDICES

	PAGE
A. FMG Frequency Management Plan for UHF Telemetry Bands	A-1
B. Use Criteria for Frequency Division Multiplexing	B-1
C. PCM Standards Additional Information and Recommendations ..	C-1
D. PAM Standards Additional Information and Recommendations ..	D-1
E. PDM Standards Additional Information and Recommendations (Deleted, see note)	E-1
F. Magnetic Tape Recorder/Reproducer Information and Use Criteria	F-1
G. Index	G-1

REVISED NOVEMBER 1975

LIST OF TABLES

	PAGE
1. Radio Frequency Telemetry Assignments	2
2. Proportional-Bandwidth FM Subcarrier Channels	8
3. Constant-Bandwidth FM Subcarrier Channels	10
4. Reference Signal Usage	11
5. Double Sideband AM Subcarrier Channels (Deleted, see note)	14
6. Receiver Intermediate Frequency Bandwidth (3 dB)	18A
7. Direct-Record Parameters	33
8. Constant-Amplitude Speed-Control Signals	36
9. Predetection Carrier Parameters	36
10. Single-Carrier and Wideband FM Record Parameters	37
11. PCM Formats	39
12. PDM Record Parameters (Deleted, see note)	44
13. Tape Dimensions	50
14. Tape Strength	53
15. Flexibility	53
16. Measurement Wavelength (Mils)	54
17. Suggested Tape Requirement Limits	56
18. Durability Signal Losses	57
19. Dimensions-Recorded Tape Format-14 Tracks on $\frac{1}{2}$ " wide tape	F-2
20. Dimensions-Recorded Tape Format-21 Tracks on $\frac{1}{2}$ " wide tape	F-3
21. Dimensions-Recorded Tape Format-28 Tracks on 1" wide tape	F-4
22. Dimensions-Recorded Tape Format-42 Tracks on 1" wide tape	F-5

REVISED NOVEMBER 1975

APPENDICES

	PAGE
A. FMG Frequency Management Plan for UHF Telemetry Bands	A-1
B. Use Criteria for Frequency Division Multiplexing	B-1
C. PCM Standards Additional Information and Recommendations ..	C-1
D. PAM Standards Additional Information and Recommendations ..	D-1
E. PDM Standards Additional Information and Recommendations (Deleted, see note)	E-1
F. Magnetic Tape Recorder/Reproducer Information and Use Criteria	F-1
G. Index	G-1

LIST OF FIGURES

	PAGE
1. PCM Major Frame Structure	16
1-A. PCM Code Definition	18
2. 50 Percent Duty Cycle PAM with Amplitude Synchronization ..	20
3. 100 Percent Duty Cycle PAM with Amplitude Synchronization ..	20
4. PDM Pulse Train Waveform (Deleted, see note)	24
5. Analog Tape Geometry	29
6. Analog Head Configuration	30
7. PCM Track System	41
8. PCM Head Configuration	42
9. Spectral Density of Random NRZ, BIØ and DM Coding	C-2
10. Theoretical BEP Performance for Various Baseband PCM Signaling Techniques (Perfect BIT Assumed)	C-3
11. Recorded Tape Format	F-6
12. Tape Crossplay	F-8

FOOTNOTES

1. Certain short-term waivers that have been granted to DOD components will permit some flexibility in effecting full conversion to UHF telemetry. Users with waivers which permit continued operations in the 225-260 MHz band will adhere to telemetry standards contained in Chapter 1 of this publication.
2. For radiated measurements this value will be the equivalent of -25 dbm as referenced to the unmodulated carrier power.
3. Flight testing telemetry is defined as telemetry which is used in support of research, development, test and evaluation, and which is not integral to the operational function of the system.
4. W-T-001553, Tape, Recording, Instrumentation, Amendment 2.
5. Reels and Hubs for Magnetic Recording Tape. General Specifications for (W-R-175B) Reels, Standard, Fiberglass and Metallic. 3-Inch Center-Hole (W-R-175/3b) Reels, Precision, Aluminum and Magnesium; 3-Inch Center-Hole (W-R-175/4b) Reels, Precision, Glass Flange With Aluminum Hub; 3-Inch Center-Hole (W-R-175/6-T).
6. K. M. Uglow, "Noise and Bandwidth in FM/FM Radio Telemetry," IRE Transactions on Telemetry and Remote Control, May 1957, pp. 19-22.

CHAPTER 1

INTRODUCTION

Section I. GENERAL

1-1. General.

The Telemetry Group of the Range Commanders Council (RCC) has prepared this document of standards to foster the compatibility of telemetry transmitting, receiving, and signal processing equipment at all the Test and Evaluation (T&E) ranges under the cognizance of the RCC. The Range Commanders highly recommend that telemetry equipment operated at the T&E ranges, and telemetry equipment utilized by the range user in programs that require test range support, conform to these standards.

1-2. Scope.

These standards do not necessarily define the existing capability of any test range but constitute a guide for the orderly implementation and application of telemetry systems for both the ranges and range users. The scope of capabilities attainable with the utilization of these standards requires careful consideration of tradeoffs. Guidance concerning these tradeoffs is provided in the text.

1-3. Purpose.

These current standards provide development and coordination agencies with the necessary criteria on which to base equipment design and modification. The ultimate purpose is to ensure efficient spectrum and interference-free operation of the radio link for telemetry systems at the RCC member ranges.

a. A companion document 118-73 (Revised July 1975) - Test Methods for Telemetry Systems and Subsystems - has been published in conjunction with 106-73 (Revised November 1975).

b. It is the policy of the Telemetry Group to update the Telemetry Standards and Test Procedures approximately every two years. IRIG 106-73 (Revised November 1975) supersedes IRIG 106-73 and all previous standards listed in Section 1 of 106-73. IRIG 118-73 (Revised July 1975) supersedes IRIG 118-73.

c. Metric conversions are included in this edition and are shown following the conventional units.

1-4. Reference Documents.

Reference documents are identified at the point of reference.

1-5. Definitions

Commonly used terms are as defined in any standard reference glossary or dictionary unless otherwise indicated. Definitions of terms with special application are included where the term first appears.

1-6. General Statements or Requirements

The general statements or requirements are contained in each section of this document.

Section II. DETAILED REQUIREMENTS

1-7. Frequency Parameters and Criteria of Telemetry Transmitter and Receiver Systems

Throughout this Section, and applicable to all systems in this document, when specifying radio-frequency bandwidth, the transmitter and receiver shall be considered a system. Systems not adhering to these standards will be subjected to a critical review.

1-8. Frequency Band 225 to 260 MHz.

This frequency band was reallocated to fixed and mobile communications services effective 1 January 1970. The Military Communications Electronics Board will consider temporary VHF telemetry waivers, on an individual basis, subject to the following limitations:

- a. Military test vehicles used must be part of the current inventory and originally configured with 225-260 MHz telemetry systems.
- b. Available facts must clearly support the contention that the use of telemetry equipment in the 1435-1535 MHz or 2200-2290 MHz bands would be prohibitively expensive or impractical, or that significant test program slippage would occur if conversion/retrofit is required.
- c. Ranges and test sites selected to support the proposed operations can provide VHF telemetry support without installation of additional equipment.
- d. Operations will be limited to the frequency bands listed in Table 1 below,

TABLE 1 - Radio Frequency Telemetry Assignments

226.7 MHz	237.0 MHz	246.3 MHz	*258.5 MHz
230.4 MHz	239.4 MHz	248.6 MHz	259.7 MHz
231.9 MHz	240.2 MHz	250.7 MHz	
232.9 MHz	244.3 MHz	253.8 MHz	
235.0 MHz	245.3 MHz	256.2 MHz	

*Not available for telemetry waiver beyond 1 January 1975, due to conflict with planned satellite communications.

e. The use of VHF telemetry on the foregoing frequencies beyond 1 January 1975 will not be a bar to the satisfaction of communications needs for which the 225-400 MHz band is primarily allocated.

f. Frequency allocation applications proposing development or procurement of new telemetry equipment designed to operate in the 225-260 MHz band will not be approved.¹

CHAPTER 2

TRANSMITTER AND RECEIVER SYSTEMS

Section I. 225 to 260 MHZ FREQUENCY BAND

2-1. Transmitter Systems

a. Frequency Tolerance. The transmitter radio-frequency carrier (modulated or unmodulated) shall be within 0.01 per cent of the assigned frequency under all operating conditions and environments. The specified frequency tolerance is applicable for any or all operations in which the conducted power level is greater than -25 dbm for a duration of one or more seconds. If radiated measurements become necessary for the determination of frequency, the ± 0.01 per cent frequency tolerance shall apply when a field intensity of greater than 150 microvolts per meter for one or more seconds is experienced at any radial distance of 100 feet (30.48m) from the transmitter antenna systems.

b. Power. The maximum allowable power shall be 100 watts; the power used should never be more than absolutely necessary for reliable telemetry transmission.

c. Spurious Emission and Interference Requirements (using test methods and equipment in accordance with applicable Military Standard or Specification).

(1) Spurious Emission (Antenna Conducted or Antenna Radiated - 0.150 to 10,000 MHz). Emissions from the transmitter-antenna system are of primary importance. Spurious and harmonic outputs, antenna-conducted (i.e., measured in the antenna transmission line) or antenna-radiated (i.e., measured in free space), shall be limited to the values derived from the formula:

$$\text{db (down from unmodulated carrier)} = 55 + 10 \log_{10} P_t$$

where P_t is the measured output power in watts.

NOTE

This limits all conducted spurious and harmonic emissions to a maximum power level of -25 dbm.

Radiated tests will only be used when the transmission line is inaccessible for conducted measurements.

Conducted or radiated spurious emissions will be checked under unmodulated conditions.

(2) Interference (Conducted or Radiated). All interference voltages (0.150 to 25 MHz) conducted by the power leads and interference fields (0.150 to 10,000 MHz) radiated directly from equipment, units, or cables, shall be within the limits specified by the applicable Military Standard or Specification.

d. Bandwidth (Transmitter Modulated). The power level in any 3 KHz bandwidth between $f_o + 320$ KHz and $f_o + 500$ KHz, and between $f_o - 320$ KHz and $f_o - 500$ KHz shall be at least 40 db below the unmodulated carrier power in the transmission line or -25 dbm, whichever is greater. The power level in any 3 KHz bandwidth beyond $f_o \pm 500$ KHz shall be no greater than -25 dbm. All bandwidth measurements (spectrum analysis) will be made with instruments having a 3 db resolution bandwidth of 3 KHz.

2-2. Receiver Systems

a. Spurious Emissions (0.150 to 10,000 MHz). Radio frequency energy, both radiated from the unit and antenna conducted, shall be within the limits specified in the applicable Military Standard or Specification.

b. Interference Protection. Radio frequency interference protection shall be provided only for systems using receivers which meet the following criteria:

(1) Frequency Tolerance. The combined errors of all local oscillators of discretely-tuned, crystal-controlled receivers shall not exceed 0.001 per cent of the assigned frequency under all operating conditions.

(2) Spurious Response (0.150 to 10,000 MHz). Shall be more than 60 db below the fundamental frequency response.

(3) Flexibility of Operation. The system shall operate on any of the frequencies in Table I, without design modification.

(4) Bandwidth. A maximum bandwidth of 1.2 MHz (± 600 KHz), as reference to the 60 db points, will be permitted.

Section II. 1435-1535 MHZ AND 2200-2300 MHZ FREQUENCY BANDS

2-3. Band Spacing.

Narrowband channel spacing of these bands is in increments of 1 MHz beginning with the frequency 1435.5 MHz in the 1435 to 1535 MHz band and beginning with the frequency 2200.5 MHz in the 2200 to 2300 MHz band. Wideband channels are permitted. They will be centered on the center frequency of narrowband channels. Refer to Appendix A for guidance on specific radio frequencies available for satisfying various channel bandwidth requirements.

2-4. Allocation of 1435-1535 MHz band.

This band is nationally allocated to government and non-government telemetry use on a shared basis. Telemetry assignments will be made therein for flight testing³ of manned and unmanned aircraft, missiles, space vehicles or major components thereof, as described below:

a. 1435-1485 MHz. Use of these channels is primarily for flight testing of manned aircraft, and secondarily for flight testing of unmanned aircraft and missiles or major components thereof.

b. 1485-1535 MHz. Use of these channels is primarily for flight testing of unmanned aircraft and missiles or major components thereof, and secondarily for flight testing of manned aircraft.

2-5. Allocation of 2200-2300 MHz Band

Telemetry other than flight testing of manned aircraft is described below. Refer to Appendix A for guidance on specific radio frequencies available for satisfying various channel bandwidth requirements.

a. 2200-2290 MHz. Use of these channels is on a co-equal shared basis with government fixed and mobile communications. Use of these channels includes telemetry associated with launch vehicles, missiles, upper atmosphere research rockets, and space vehicles, regardless of their trajectories.

b. 2290-2300 MHz. Channels in this band are for space research telemetry on a shared basis with fixed and mobile services.

2-6. Transmitter Systems

a. Frequency Tolerance. The transmitter radio-frequency carrier, (modulated or unmodulated) shall be within 0.003 per cent of the assigned radio frequency under all operating conditions and environments.

NOTE

Between 1 and 5 seconds after initial turn-on, the transmitter radio frequency shall remain within 0.005 per cent of the assigned radio frequency. After 5 seconds, the specified frequency tolerance is applicable for any and all operations in which the conducted power level is greater than -25 dbm for a duration of one or more seconds. If radiated measurements become necessary for the determination of frequency, the ± 0.003 per cent frequency tolerance shall apply when a field intensity of greater than 500 microvolts per meter is experienced at any radial distance of 100 feet (30.48 meters) from the transmitter system.

b. Power. The power shall be as directed by the intended use, and never more than absolutely necessary for reliable telemetry reception.

c. Spurious Emission and Interference Requirements Using Test Methods and Equipment in Accordance With Applicable Military Standards or Specification. (Antenna Conducted or Antenna Radiated 0.150 to 10,000 MHz).

(1) Emissions from the transmitter-antenna system are of primary importance. Spurious and harmonic outputs, antenna-conducted (i.e., measured in the antenna transmission line) or antenna-radiated (i.e., measured in free space), shall be limited to the values derived from the formula:

db (down unmodulated carrier) = $55 + 10 \log_{10} P_t$
where P_t is the measured output power in watts.

NOTE

This limits all conducted spurious and harmonic emissions to a maximum power level of -25 dbm.

Radiated tests will only be used when the transmission line is inaccessible for conducted measurements.

Conducted or radiated spurious emissions will be checked under unmodulated conditions.

(2) Interference (Conducted and Radiated). All interference voltages (0.150 to 25 MHz) conducted by the power leads and interference fields (0.150 to 10,000 MHz) radiated directly from equipment, units or cables, shall be within the limits specified by the applicable Military Standard or Specification.

d. Flexibility of Operation. The transmitter shall be capable of operating throughout the entire frequency band from 1435 to 1535 MHz and/or 2200-2300 MHz, without design modifications.

e. Bandwidth (Transmitter Modulated). Refer to paragraph 5 of Appendix A, for channel bandwidth definitions and spacing allocations and to paragraph 7 of Appendix A for standards for the level of undesired emissions outside the authorized bandwidth for telemetering stations excluding those for space radio communications in the 1435-1535 and 2200-2290 MHz bands.

2-7. Receiver Systems.

a. Spurious Emissions (0.150 to 10,000 MHz). Radio-frequency energy, both radiated from the unit and antenna-conducted, shall be within the limits specified in the applicable Military Standard or Specification.

b. Interference Protection. Radio-frequency interference protection will be provided only for systems using receivers which meet the following criteria:

(1) Frequency Tolerance. The combined errors of all local oscillators of the receivers shall not exceed 0.001 per cent of the assigned frequency under operating conditions during mission support.

(2) Spurious Responses (0.150 to 10,000 MHz). Shall be more than 60 db below the fundamental frequency response.

(3) Flexibility of Operation. The system shall be operable over the entire 1435 to 1535 MHz band and/or 2200 to 2300 MHz band, without design modification, and will have variable bandwidth selection.

CHAPTER 3

FREQUENCY DIVISION MULTIPLEXING TELEMETRY STANDARDS

Section I. INTRODUCTION

3-1. General

In frequency division multiplexing, each data channel makes use of a separate subcarrier which occupies a defined position and bandwidth in the modulation baseband of the RF carrier. Two types of FM subcarrier formats may be utilized; the data bandwidth of one type is proportional to the center frequency of the subcarrier, while the data bandwidth of the other type is constant, regardless of subcarrier frequency.

3-2. Scope

The following sections set forth the standards for utilization of FM frequency division multiplexing.

Section II. FM SUBCARRIERS

3-3. Characteristics

In these systems, one or more subcarrier signals, each at a different frequency, are employed to frequency modulate (FM) or phase modulate (PM) a transmitter in accordance with the radio-frequency conditions specified in Chapter 2.

a. Each of the subcarriers convey measurement data in the form of frequency modulation. The number of data channels may be increased by modulating one or more of the subcarriers with a time division multiplex format such as Pulse Code Modulation (PCM), Pulse Amplitude Modulation (PAM).

b. The selection and grouping of subcarrier channels depend upon the data bandwidth requirements of the application at hand, and upon the necessity to ensure adequate guard bands between channels. Combinations of both proportional-bandwidth channels and constant-bandwidth channels may be used.

3-4. FM Subcarrier Channel Characteristics

Table 2 lists the standard proportional-bandwidth FM subcarrier channels. The channels identified with letters permit ± 15 per cent subcarrier deviation rather than ± 7.5 per cent

TABLE 2. PROPORTIONAL-BANDWIDTH FM SUBCARRIER CHANNELS

±7.5% CHANNELS

Channel	Center Frequencies (Hz)	Lower Deviation Limit* (Hz)	Upper Deviation Limit* (Hz)	Nominal Frequency Response (Hz)	Nominal Rise Time (ms)	Maximum Frequency Response** (Hz)*	Minimum Rise Time** (ms)
1	400	370	430	6	58	30	11.7
2	560	518	602	8	42	42	8.33
3	730	675	785	11	32	55	6.40
4	960	886	1,032	14	42	72	4.86
5	1,300	1,202	1,398	20	18	98	3.60
6	1,700	1,572	1,828	25	14	128	2.74
7	2,300	2,127	2,473	35	10	173	2.03
8	3,000	2,775	3,225	45	7.8	225	1.56
9	3,900	3,607	4,193	59	6.0	293	1.20
10	5,400	4,995	5,805	81	4.3	405	.864
11	7,350	6,799	7,901	110	3.2	551	.635
12	10,500	9,712	11,288	160	2.2	788	.444
13	14,500	13,412	15,588	220	1.6	1,088	.322
See Sec. 3-4							
14	22,000	20,350	23,650	330	1.1	1,650	.212
15	30,000	27,750	32,250	450	.78	2,250	.156
16	40,000	37,000	43,000	600	.58	3,000	.117
17	52,500	48,562	56,438	790	.44	3,938	.089
18	70,000	64,750	75,250	1050	.33	5,250	.067
19	93,000	86,025	99,975	1395	.25	6,975	.050
See Sec. 3-5							
20	124,000	114,700	133,300	1860	.19	9,300	.038
21	165,000	152,624	177,375	2475	.14	12,375	.029

±15% CHANNELS***

A	22,000	18,700	25,300	660	.53	3,330	.106
B	30,000	25,500	34,500	900	.39	4,500	.078
C	40,000	34,000	46,000	1200	.29	6,000	.058
D	52,500	44,625	60,375	1575	.22	7,875	.044
E	70,000	59,500	80,500	2100	.17	10,500	.033
F	93,000	79,050	106,950	2790	.13	13,950	.025
G	124,000	105,400	142,600	3720	.09	18,600	.018
H	165,000	140,250	189,750	4950	.07	24,750	.014

* Rounded off to nearest Hz.

** The indicated maximum data frequency response and minimum rise time is based upon the the maximum theoretical response that can be obtained in a bandwidth between the upper and lower frequency limits specified for the channels. (See Chapter 3, Sec. II and referenced discussion in Appendix B for determining possible accuracy versus response tradeoffs.)

*** Channels A through H may be used by omitting adjacent lettered and numbered channels. Channels 13 and A may be used together with some increase in adjacent channel interference.

deviation, but use the same center frequencies as the eight highest numbered channels. The channels shall be used within the limits of maximum subcarrier deviation (See Appendix B for expected performance tradeoffs at selected combinations of deviation and modulating frequency). There is a ratio of approximately 1.33 to 1 between the center frequencies of adjacent ± 7.5 per cent proportional bandwidth channels, except between 14.5 KHz and 22 KHz where a larger gap is left to provide a 60 Hz amplitude modulated 17 KHz carrier for capstan speed control of magnetic-tape recorders (See Chapter 7, para. 7-3h.(2)(a)). The use of an additional FM subcarrier between 14.5 and 22 KHz is not permissible.

NOTE

Table 3 lists the standard FM constant-bandwidth FM subcarrier channels. The letters A, B and C identify the channels for use with maximum subcarrier deviations of ± 2 KHz, ± 4 KHz and ± 8 KHz, along with maximum frequency responses of 2, 4, and 8 KHz, respectively. The channels shall be used within the limits of maximum subcarrier deviation. (See Appendix B for expected performance tradeoffs at selected combinations of deviation and modulating frequency.)

3-5. Tape Speed Control and Flutter Compensation

Tape Speed control and flutter compensation for FM/FM formats may be accomplished as indicated in 7-3 h. Use of the standard reference frequency shall be in accordance with the criteria of Table 4, when the reference signal is mixed with data.

Section III. AM SUBCARRIERS

NOTE

These standards have been deleted due to lack of use. Ranges which have an established capability are encouraged to maintain it as long as current needs exist; however, application of other standards is recommended for new programs. It is recommended that the ranges not buy new equipment related to these deleted standards.

TABLE 3. CONSTANT-BANDWIDTH FM SUBCARRIER CHANNELS

<u>A CHANNELS</u>		<u>B CHANNELS</u>		<u>C CHANNELS</u>	
Deviation limits = ± 2 KHz		Deviation limits = ± 4 KHz		Deviation limits = ± 8 KHz	
Nominal frequency response = 0.4 KHz		Nominal frequency response = 0.8 KHz		Nominal frequency response = 1.6 KHz	
Maximum frequency response = 2 KHz*		Maximum frequency response = 4 KHz*		Maximum frequency response = 8 KHz	
Channel	Center Frequency (KHz)	Channel	Center Frequency (KHz)	Channel	Center Frequency (KHz)
1A	16				
2A	24				
3A	32	3B	32	3C	32
4A	40				
5A	48	5B	48		
6A	56				
7A	64	7B	64	7C	64
8A	72				
9A	80	9B	80		
10A	88				
11A	96	11B	96	11C	96
12A	104				
13A	112	13B	112		
14A	120				
15A	128	15B	128	15C	128
16A	136				
17A	144	17B	144		
18A	152				
19A	160	19B	160	19C	160
20A	168				
21A	176	21B	176		

*The indicated maximum frequency is based upon the maximum theoretical response that can be obtained in a bandwidth between deviation limits specified for the channel. (See discussion in Appendix B for determining practical accuracy versus response tradeoffs.)

TABLE 4. REFERENCE SIGNAL USAGE
Reference and Data Signals on Same Track

<u>Reference Frequency kHz</u>	<u>Subcarrier Usage</u>
*240 ± 0.01%	For use with all center frequencies
200 ± 0.01%	For use with all center frequencies except Channel H
100 ± 0.01%	Use with center frequencies up to and including 80 KHz
50 ± 0.01%	Use with center frequencies up to and including 40 KHz except Channel C
25 ± 0.01%	Use with center frequencies up to and including 16 KHz
12.5 ± 0.01%	Use with center frequencies up to and including 7.35 KHz
6.25 ± 0.01%	Use with center frequencies up to and including 3.9 KHz
3.125 ± 0.01%	Use with center frequencies up to and including .960 KHz

* For flutter compensation only, not for tape speed control.

If the reference signal is recorded on a separate track, any of the listed reference frequencies may be used, provided the requirements for compensation rate of change are satisfied.

Table 4 shows that the 240 KHz reference frequency is the only permissible frequency when Channel H is included in the multiplex and the reference signal is mixed with the data. In addition, the 240 KHz reference signal may be used as a translation frequency in a constant-bandwidth format, provided the reference signal is suitably divided down, to 80 KHz for example.

In addition to the reference frequencies listed in Table 4, which are of the constant-amplitude type, an amplitude modulated signal centered at 17 KHz ± 0.5% may be used for servo speed correction. See Chapter 7, Paragraph 7-3 (h)(2). Channel 1A must be deleted if the 17 KHz signal is multiplexed with subcarrier signals.

CHAPTER 4

PULSE CODE MODULATION (PCM) STANDARDS

Section I. INTRODUCTION

4-1. General

Pulse Code Modulation (PCM) data, the characteristics of which are specified herein, shall be transmitted as serial binary-coded time-division multiplexed samples using the sequence of pulses within each sample to represent a discrete magnitude of the data. The standard defines recommended pulse train structure and design characteristics for the implementation of pulse code modulation telemetry systems.

Section II. DESCRIPTION AND DATA

4-2. Word and Frame Structure

The PCM frame shall contain a known number of bit intervals, all of equal duration, unless special identification bits within the bit stream indicate a change. The duration of the bit interval and the number of bit intervals per frame shall remain fixed from frame to frame. All words in the frame shall contain the same number of bit intervals. Figure 1 is a graphical representation of the following structure.

NOTE

In PCM formats, the minor frame is defined as that period between synchronization words which includes one complete cycle of the commutator having the highest rate. The major frame which includes one or more minor frames is defined as that period in which all data is sampled once.

- a. Major Frame Length. The length of the major frame shall have no restriction.
- b. Minor Frame Length. The length of a minor frame shall not exceed 8192 bit intervals, including the intervals devoted to synchronization.
- c. Minor Frame Synchronization. The minor frame synchronization information shall consist of a digital word not longer than 33 bits in consecutive bit intervals. Recommendations concerning synchronization patterns are shown in Appendix C.

REVISED NOVEMBER 1975

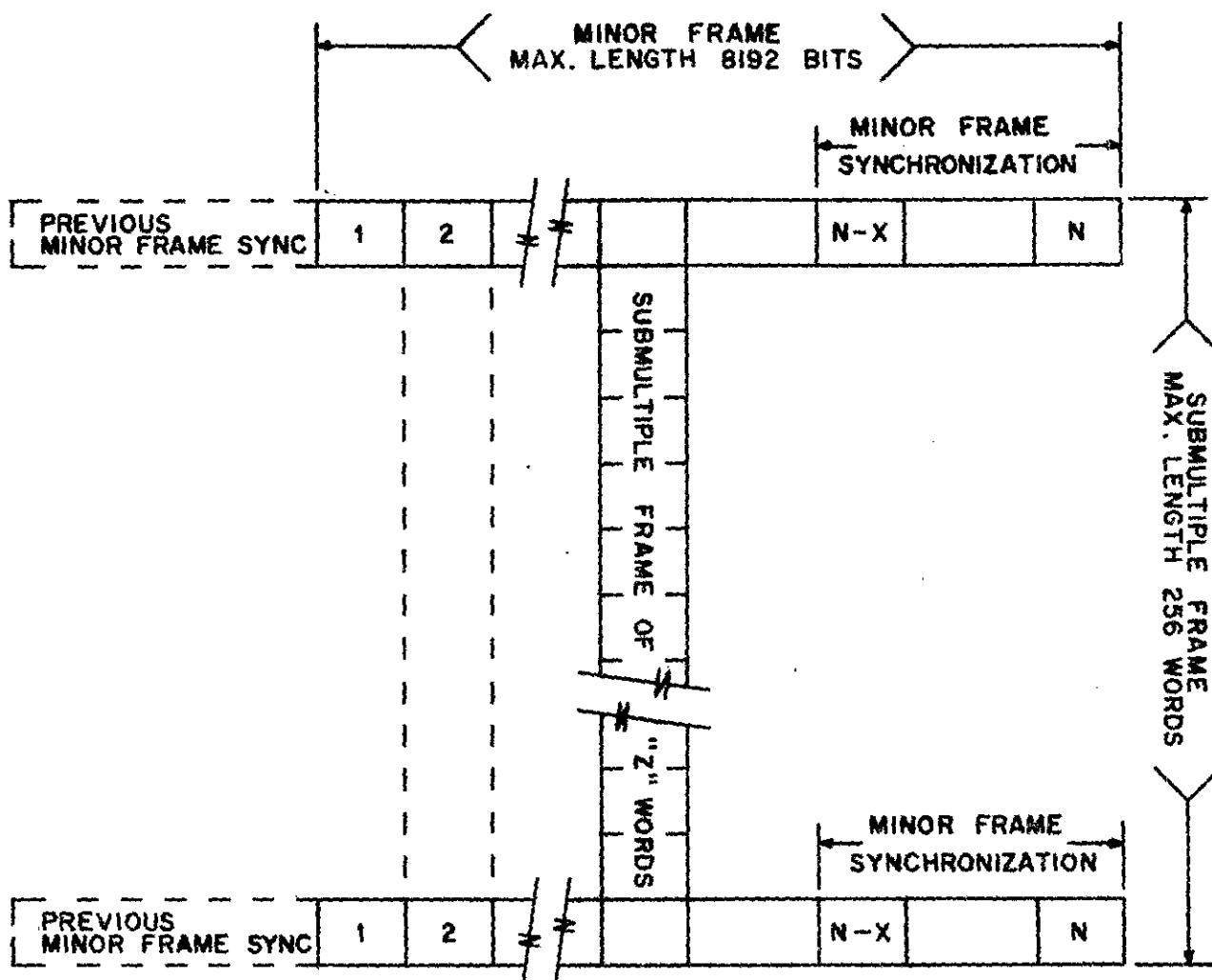

● SUBMULTIPLE FRAME SYNCHRONIZATION LOCATION IS DEPENDENT ON METHOD CHOSEN IN PARAGRAPH 4-4 a.

● BY DEFINITION A MAJOR FRAME CONTAINS (N)(Z) WORDS.

"Z" = THE NUMBER OF WORDS IN LONGEST SUBMULTIPLE FRAME .

"N" = THE NUMBER OF WORDS IN MINOR FRAME .

"X" = THE NUMBER OF WORDS IN MINOR FRAME SYNC .

Figure 1. PCM Major Frame Structure

d. Word Length. Individual words shall not be less than 4 bits nor more than 64 bits in length. Within these limits, words of different length may be multiplexed in a single minor frame. However, the length of a word in any position within a minor frame shall be constant, except during changes caused by special identification bits appearing in the bit stream.

e. Special Words. The assignment of word positions to convey special information on a programmed basis in designated minor frames is permissible. The number of bits in the substituted words, including identification and padding bits, shall equal exactly the number of bits in the replaced words.

f. Word Numbering. To provide consistent notation, the first word after synchronization shall be numbered "one." Each subsequent word shall be numbered sequentially for minor frames and submultiple frames.

g. Binary Bit Representation. The following conventions for representing binary "one" and "zero" are permissible:

NRZ-L	DM-M	BIØ-L
NRZ-M	DM-S	BIØ-M
NRZ-S		BIØ-S

Graphic and verbal descriptions of these conventions are shown in Figure 1A. Only one convention shall be used in a single PCM pulse train.

4-3. Bit Rate

The maximum bit rate is limited only by the requirements in Table 1 and Chapter 2. Receiver intermediate frequency (IF) bandwidths should be selected from Table 6. The minimum rate shall be 1 bps.

a. Bit Rate Accuracy and Stability. During any period of desired data, the bit rate shall not differ from the specified nominal bit rate by more than 1 percent of the nominal rate.

b. Bit Jitter. Any transition in the PCM waveform occurring within interval P shall occur within 0.1 bit period of the time at which such transition is expected to occur based upon the measured average bit period as determined during the immediately preceding interval P. The interval P for the purpose of this requirement, shall be equal to the measured time for five successive minor frames.

$$\text{Average Bit Period} = \frac{P}{\text{Specified Bits Per Minor Frame} \times 5}$$

LOGIC WAVEFORM LEVELS

CODE DESIGNATIONS

CODE WAVEFORMS

CODE DEFINITIONS

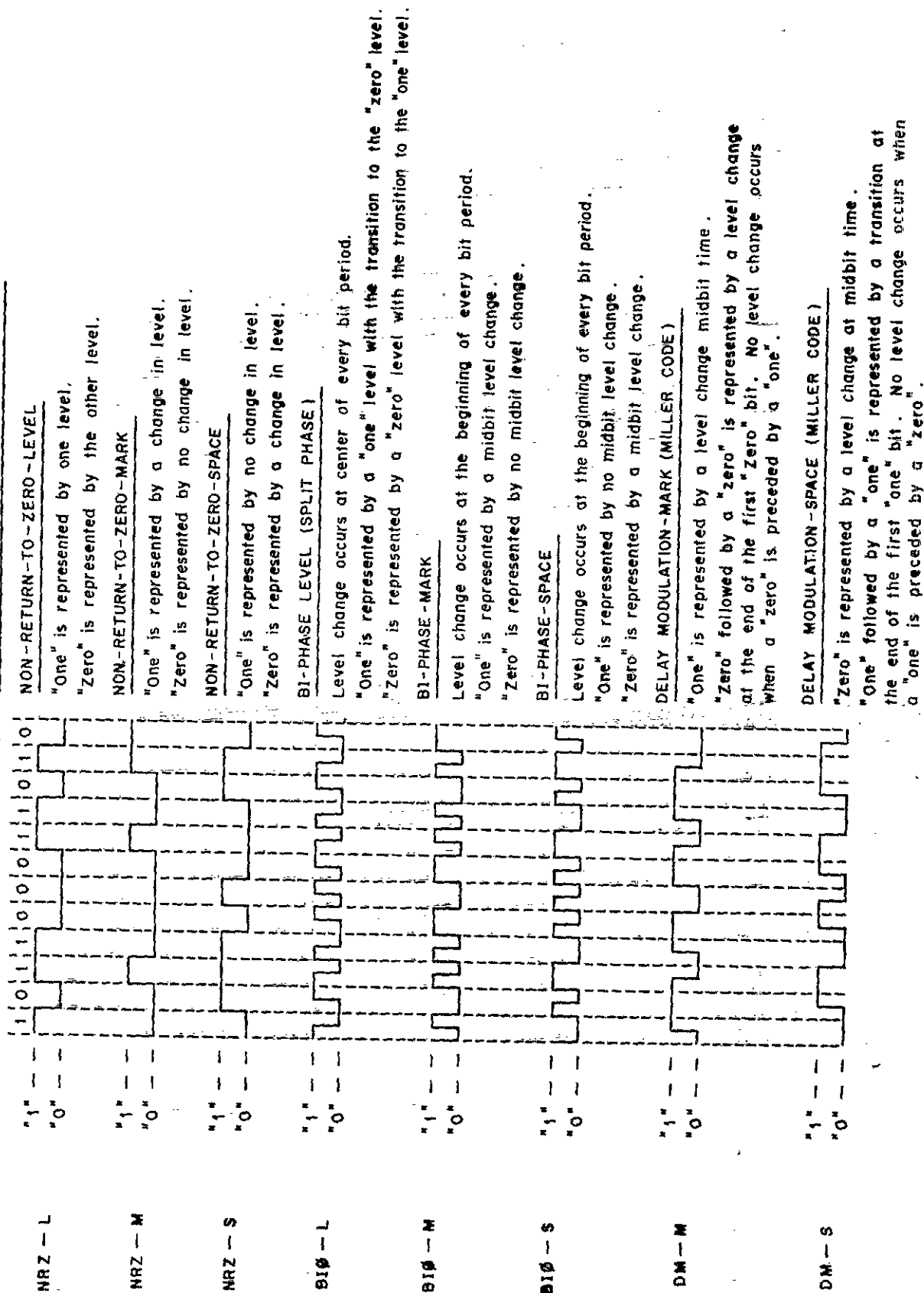

FIGURE 1A PCM CODE DEFINITION

TABLE 6

RECEIVER INTERMEDIATE FREQUENCY BANDWIDTH (3 dB)

12,500 Hz*
25,000 Hz*
50,000 Hz*
100,000 Hz
300,000 Hz
500,000 Hz
750,000 Hz
1,000,000 Hz
1,500,000 Hz
3,300,000 Hz

**System instabilities may limit the use of these bandwidths.*

4-4. Multiple and Submultiple Sampling

Data sampling at rates which are multiples or submultiples of the minor frame rate is permissible. When submultiple sampling is employed, the restrictions on minor frame length (para 4-2b.) and bit jitter (para 4-2c.) are applicable to the submultiple frame.

NOTE

A submultiple frame is defined as that period which includes one cycle of a commutator whose rate is a submultiple of the minor frame rate.

a. Submultiple Frame Synchronization Methods. Recommended methods for identifying submultiple channels are as follows:

(1) The beginning of a submultiple frame may be identified by a unique digital word within the submultiple frame and occupying the same word intervals as the submultiple frame. Each submultiple sequence will have a fixed and known relationship to the submultiple frame identification word.

(2) The beginning of a submultiple frame may be identified by a unique digital word replacing the frame synchronization word indicating start of the submultiple sequence.

(3) Each word within the submultiple sequence may contain identification bits to indicate the position of that word.

REVISED NOVEMBER 1975

b. Maximum Submultiple Frame Length. The interval of any submultiple frame, including the time devoted to synchronizing or channel identification information, shall not exceed 256 times the interval of the minor frame in which it occupies a recurring position.

4-5. Radio Frequency and Subcarrier Modulation

a. Frequency Modulation (FM). The frequency deviation of an FM RF carrier or a subcarrier shall be symmetrical about the carrier or subcarrier frequency. The deviation shall be the same for all occurrences of the same level.

b. Phase Modulation (PM). The phase deviation of a PM carrier shall be symmetrical about the unmodulated carrier. The deviation shall be the same for all occurrences of the same level.

c. PCM/FM/FM. The subcarrier channel shall be chosen such that the maximum frequency response for the channel, as shown in Tables 2 and 3, is greater than the reciprocal of twice the shortest period between transitions in the PCM waveform.

4-6. Premodulation Filtering

Premodulation Filtering is recommended to confine the radiated RF spectrum as required in Chapter 2, para. 2-1 d. and para. 2-6 e.

CHAPTER 5

PULSE AMPLITUDE MODULATION (PAM) STANDARDS

Section I. INTRODUCTION

5-1. General

Pulse Amplitude Modulated (PAM) data, the characteristics of which are specified herein, shall be transmitted as time division multiplexed analog pulses with the amplitude of the information channel pulse being the analog-variable parameter. This standard defines recommended pulse train structure and design characteristics for the implementation of pulse amplitude modulation telemetry systems.

Section II. DESCRIPTION AND DATA

5-2. Frame and Pulse Structure

Each frame shall consist of a constant number of time-sequenced channel intervals. The maximum frame length shall be 128 channel time intervals per frame, including the intervals devoted to synchronization and calibration. The pulse and frame structure shall conform to either Figure 2 or 3.

a. Commutation Pattern. The information channels are allocated equal and constant time intervals within the PAM frame. Each interval ("T" in Figures 2 and 3) contains a sample pulse commencing at the start of the interval and having amplitude determined by the amplitude of the measurand of the corresponding information channel according to a fixed relationship (usually linear) between the minimum level (zero amplitude) and the maximum level (full-scale amplitude). For 50 per cent duty cycle (RZ PAM), the zero level shall be 20 per cent to 25 per cent of full amplitude level as shown in Figure 2. The pulse width shall be the same in all time intervals (the intervals devoted to synchronization excepted). The duration shall be either $0.5T \pm 0.05T$, as shown in Figure 2, or $T \pm 0.05T$, as shown in Figure 3.

b. In-Flight Calibration. It is recommended that in-flight calibration be used and Channels 1 and 2, immediately following the frame synchronization interval, be used for zero and full-scale calibration, respectively.

c. Frame Synchronization Interval. Each frame shall be identified by the presence within it of a synchronization interval.

(1) Fifty Per Cent Duty Cycle (RZ-PAM). The synchronization pattern interval shall have a duration equal to two information channel intervals ($2T$) and shall be full-scale amplitude for $1.5T$ followed by the reference level for $0.5T$, (see Figure 2).

(2) One-Hundred Per Cent Duty Cycle (NRZ-PAM). The synchronization pattern shall be, in the order given, zero level for a period T , full-scale amplitude for a period $3T$, and a level not exceeding 50 per cent full-scale amplitude for a period T , (see Figure 3).

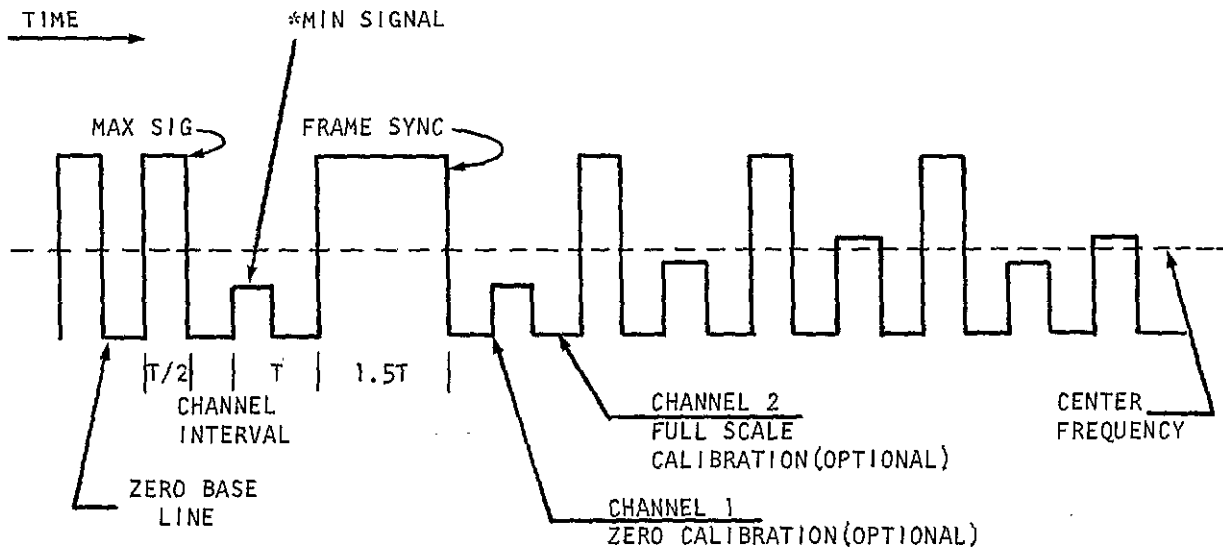

*20 to 25 percent deviation reserved for pulse synchronization is recommended
 FIGURE 2 50 PERCENT DUTY CYCLE PAM WITH AMPLITUDE SYNCHRONIZATION

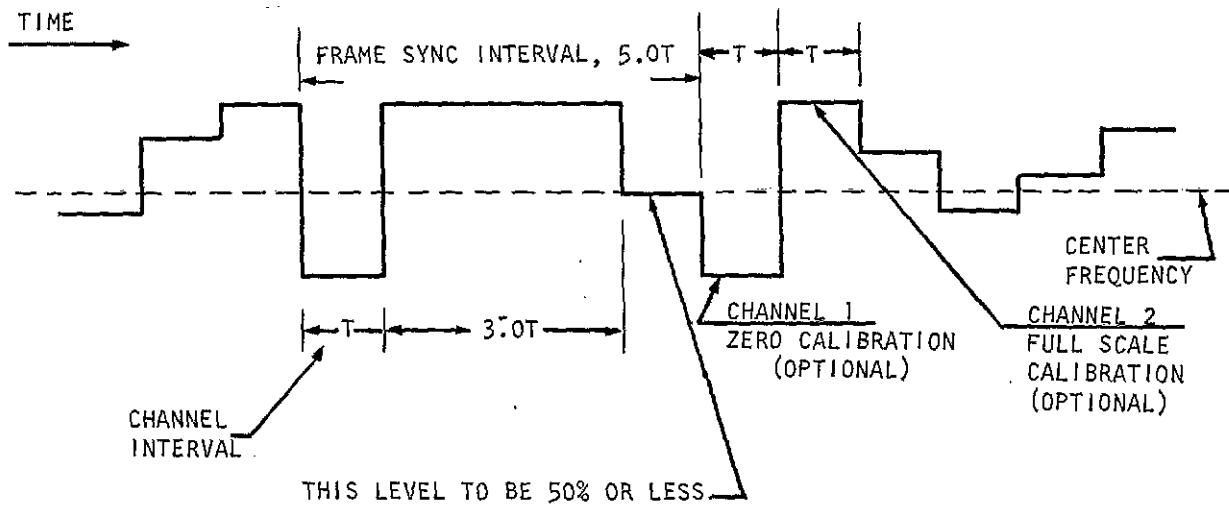

FIGURE 3 100 PERCENT DUTY CYCLE PAM WITH AMPLITUDE SYNCHRONIZATION

d. Maximum Pulse Rate. The maximum pulse rate shall not be greater than that permitted by the following:

(1) PAM/FM/FM. The reciprocal of the shortest interval between transitions in the PAM pulse train shall be not greater than one-fifth of the total (peak-to-peak) deviation specified in Chapter 3 and Tables 2 and 3, for the FM subcarrier selected.

(2) PAM/FM. The reciprocal of the shortest interval between transitions in the PAM pulse train shall be limited by whichever is narrower of the following:

(a) One half of the 3 db frequency of the premodulation filter when employed.

(b) One fifth of the intermediate frequency (IF) bandwidth (3 db points) selected from the IF bandwidths listed in Table 6.

5-3. Frame and Pulse Rate

The frame and pulse parameters listed below may be used in any combination:

A minimum rate of 0.125 frames per second.

A maximum pulse rate as specified in para. 5-2 d.

a. Long Term Accuracy and Stability. During the period of desired data, the time between the occurrence of corresponding points in any two successive frame synchronization intervals shall not differ from the reciprocal of the specified nominal frame rate by more than 5 per cent of the nominal period.

b. Short Term Stability. During a measured period, P, for the occurrence of 1000 channel intervals, the time between the start of any two successive channel intervals (synchronization intervals excepted) shall not differ from the average channel interval established by the formula $T_{ave} = \frac{P}{1000}$ by more than 1 per cent of the average interval.

5-4. Multiple and Submultiple Sampling Rates

Data multiplexing at sampling rates which are multiples and submultiples of the frame rate is permissible.

a. Submultiple Frame Synchronization. The beginning of the longest submultiple frame interval shall be identified by the transmission of a synchronization pattern. All other submultiple frames shall have a fixed and known relationship to the identified submultiple frames.

(1) Fifty Per Cent Duty Cycle (RZ). The presence of a full scale amplitude pulse in two successive occurrences of the same frame channel interval allocated to data channels of the identified submultiple frame. The first such pulse shall have a duration equal to the channel interval; the second pulse shall have a duration nominally one-half the channel interval.

(2) **One-Hundred Per Cent Duty Cycle (NRZ).** The presence of synchronization information in five successive occurrences of the same frame channel interval allocated to data channels of the identified submultiple frame. The amplitude of the data channels assigned for synchronization shall be as follows:

- (a) First Occurrence - Zero amplitude
- (b) Second, Third, and Fourth Occurrences - Full-scale amplitude.
- (c) Fifth Occurrence - Not more than 50 per cent of full-scale amplitude.

b. **Maximum Submultiple Frame Length.** The interval of any submultiple frame, including the time devoted to synchronizing information, shall not exceed 128 times the interval of the frame in which it occupies a recurring position.

5-5. Frequency Modulation

The frequency deviation of an FM carrier or subcarrier, which represents the maximum and minimum amplitude of a PAM waveform, shall be equal and opposite with respect to the assigned carrier or subcarrier frequency. The deviation shall be the same for all occurrences of the same level.

5-6. Premodulation Filtering

Premodulation filtering is recommended to restrict the radiated spectrum as specified in Chapter 2, para. 2-1 d. and para. 2-6 e. Recommended filter characteristics are shown in Appendix D.

REVISED NOVEMBER 1975

CHAPTER 6

PULSE DURATION MODULATION (PDM) STANDARD

NOTE

This Standard has been deleted due to lack of use. Ranges which have an established capability are encouraged to maintain it as long as current needs exist; however, application of other standards is recommended for new programs. It is recommended that the ranges not buy new equipment related to this standard.

CHAPTER 7

MAGNETIC-TAPE RECORDER/REPRODUCER STANDARDS

Section I. INTRODUCTION

7-1. General

These standards define terminology and standardize the recorder/reproducer configuration required to assure crossplay compatibility between tapes recorded at one range facility and reproduced at another. They are also intended to serve as a guide in the procurement of airborne magnetic tape recording equipment so that standard reproduction equipment on the ground may be used. Test procedures for magnetic tape recording/reproducing devices used for telemetry data storage appear in Chapter 2 of IRIG document 118-73: Standards applying to magnetic tapes are contained in Chapter 8 of this document.

Section II. COMPATIBILITY REQUIREMENTS

7-2. Fixed Head Recorder/Reproducer

In order to allow maximum interchange of telemetry magnetic tape records and recording equipment between the test ranges, standard recording techniques and tape configurations are required. Any one of the several methods of information storage set forth here may be used, or any compatible combination may be used simultaneously.

a. Tape Speeds. The standard tape speeds for instrumentation magnetic tape recorders are 1 7/8 ips (47.6 mm/s); 3 3/4 ips (95.3 mm/s); 7 1/2 ips (190.5 mm/s); 15 ips (381 mm/s); 30 ips (762 mm/s); 60 ips (1524 mm/s); and 120 ips (3048 mm/s).

b. Record/Reproduce Bandwidths. For purposes of the standards, four bandwidths are designated:

(1) Low Band. Direct record response to 100,000 Hz nominal at 60 ips (1524 mm/s). For recording subcarrier bands above Proportional Bandwidth Channel 18 or Constant Bandwidth Channel 11B, intermediate-band recorders are recommended.

(2) Intermediate Band. Direct record response to 250,000 Hz nominal at 60 ips (1524 mm/s) or 500,000 Hz nominal at 120 ips (3048 mm/s).

(3) 1.5 Wideband. Direct record response to 1.5 MHz nominal at 120 ips (3048 mm/s). Interchange of tapes between wideband and low- or intermediate-band machines is NOT recommended.

(4) 2.0 Wideband. Direct record response to 2.0 MHz at 120 ips (3048 mm/s). Interchange of tapes between wideband and low- or intermediate-band machines is NOT recommended.

7-3. Direct Recording

A method of recording on magnetic tape using high-frequency bias in which the electrical input signal is delivered to the recording head in unaltered form.

a. **Magnetic Tape and Reel Characteristics.** Magnetic tape and reel characteristics are specified in Chapter 8. It is recommended that all recorder/reproducer systems at a particular Range be calibrated for operational use against a manufacturer's centerline tape of the type used by the Range for each class of recorder/reproducer system. Additional supplementary procurement specifications may be required to meet a particular operational requirement of the Ranges.⁴

(1) **Tape Widths.** The standard nominal tape widths for direct recording are ½ inch (12.7mm) and 1 inch (25.4 mm).

(2) **Track Geometry.** See Figure 5, Analog Tape Geometry. (See Appendix F for several configurations not now included in these Standards.)

(a) The track width for multiple track recording shall be 0.050 ± 0.005 inch (1.27 ± 0.13 mm). Track width is defined as the physical width of the magnetic head that would be used to record any given track. The actual width of the recorder track may be somewhat greater because of the magnetic fringing effect around each record head. See Figure 6, Analog Head Configuration.

(b) Tracks shall be spaced 0.070 inch (1.78 mm) center-to-center across the tape. Track location shall be as shown in Figure 5. Although a tape reference edge is specified, edge guiding of the tape is not an implied requirement of the recorder/reproducer. The ½ inch (12.7 mm) tape contains seven tracks with one track located approximately on the center of the tape and the 1 inch (25.4 mm) tape contains 14 tracks with the center of the tape approximately midway between tracks 7 and 8.

(c) The tracks on a tape shall be numbered consecutively, starting with track number 1, from top to bottom when viewing the oxide-coated side of a tape with the earlier portion of the recorded signal to the observer's right.

b. **Head and Head-Stack Configuration.** See Figure 6.

(1) **Head Placement.** The standard placement is to locate the heads (both record and playback) for alternate tracks in separate head stacks. Thus to record on all tracks of a standard-width tape, two record head stacks will be used; to reproduce all tracks of a standard-width tape, two playback head stacks will be used.

(2) **Head Stack Placement.** The two stacks of a head pair (record or reproduce) shall be mounted in such a manner that the centerlines through the head gaps of each stack are parallel and spaced 1.500 ± 0.001 inches (38.10 ± 0.03 mm) apart for fixed head stacks. For intermediate-band or wideband heads where azimuth adjustment of the reproduce-head stacks is required, the stack spacing shall be 1.500 ± 0.002 inches (38.10 ± 0.05 mm) between gap centerlines including maximum azimuth adjustment required to allow meeting system performance requirements.

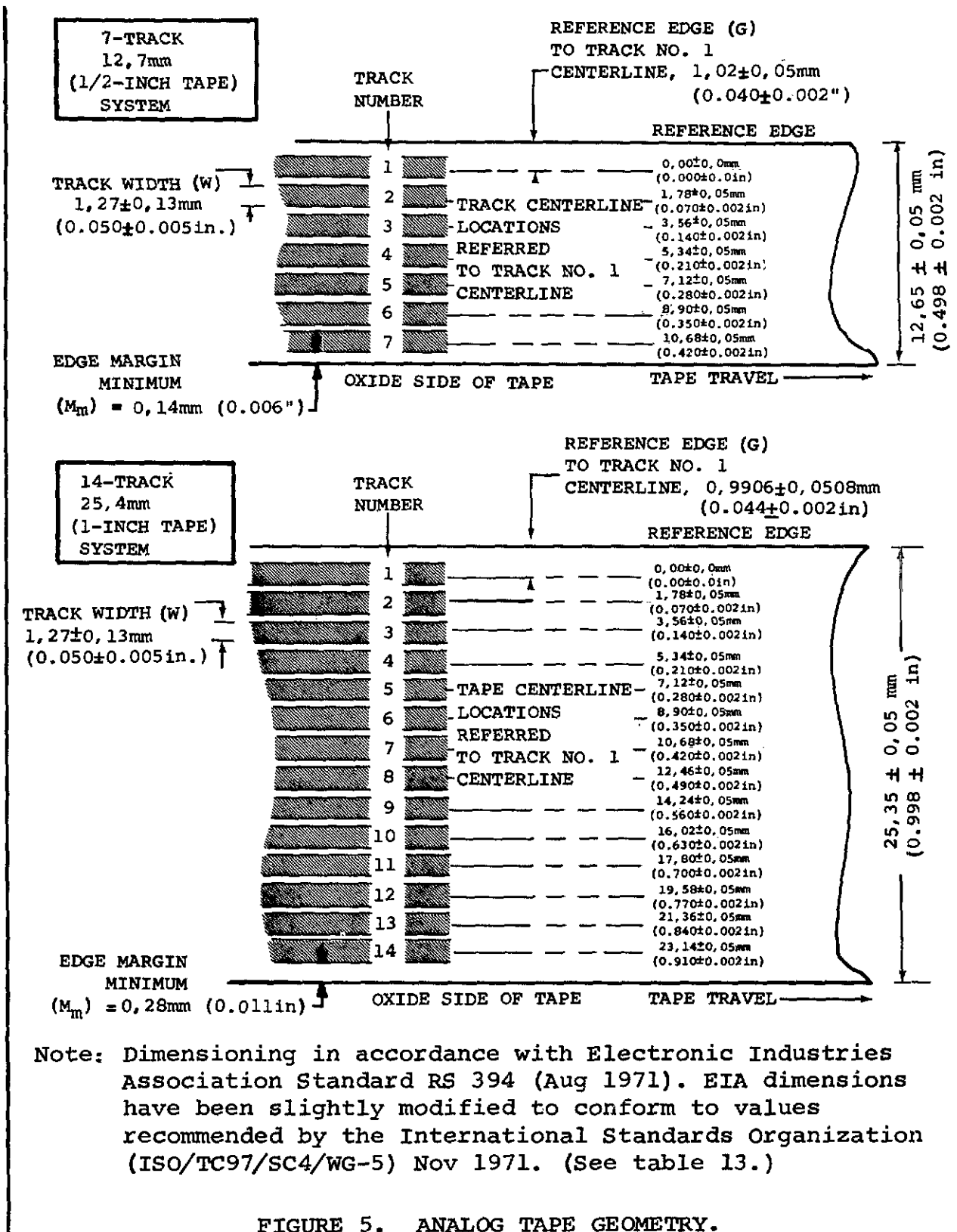

FIGURE 5. ANALOG TAPE GEOMETRY.

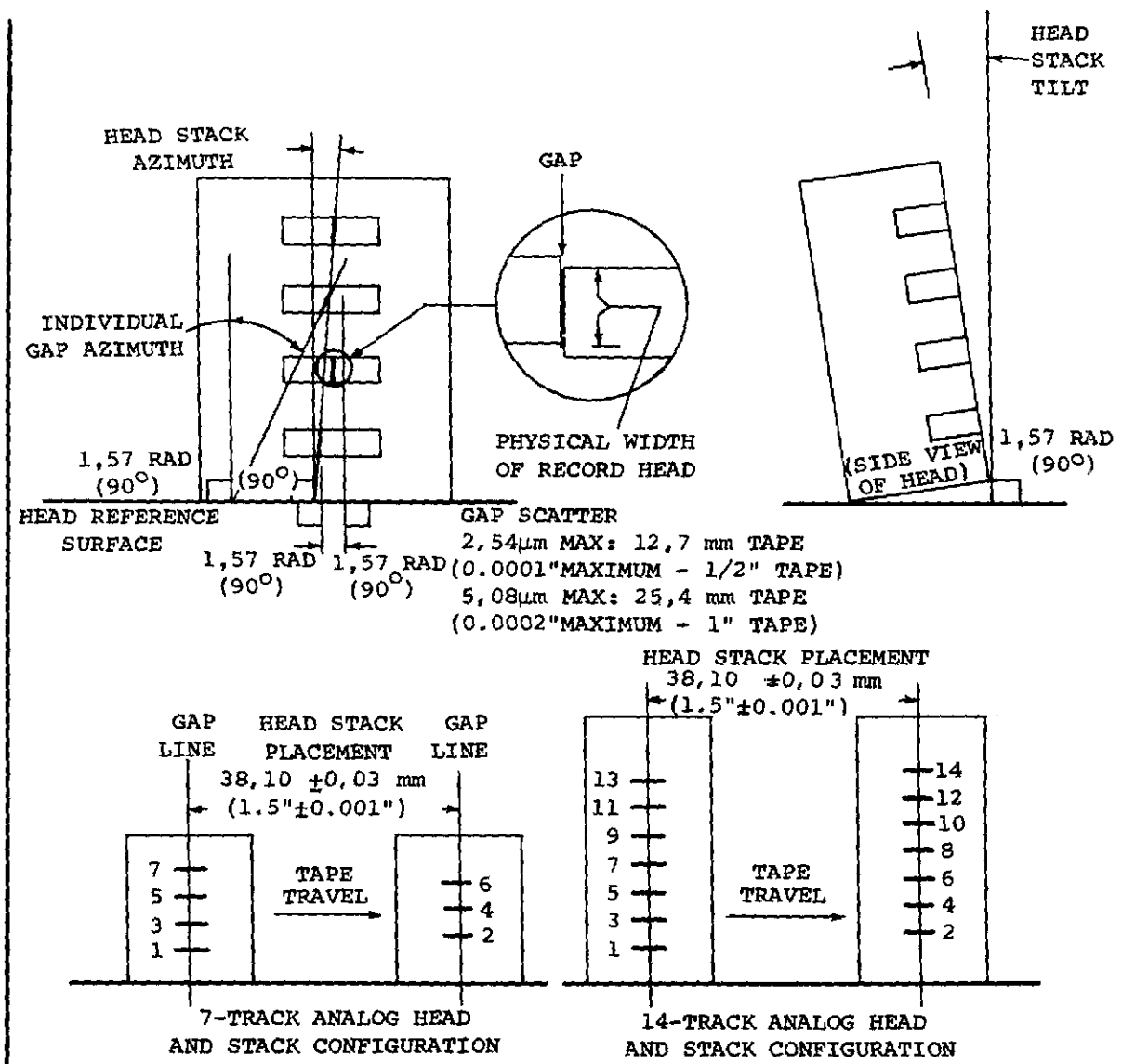

FIGURE 6. ANALOG HEAD CONFIGURATION.

(3) Head-Stack Numbering. Head-stack number 1 of a pair of stacks (record or reproduce) is the first stack over which an element of tape passes when moving in the normal record or reproduce direction.

(4) Head and Stack Numbering. Numbering of a record or reproduce head shall correspond to the track number on the magnetic tape which that head normally records or reproduces. Stack number 1 of a pair will contain all odd-numbered heads, while stack number 2 will contain all even-numbered heads.

(5) Head-Stack Tilt. The plane tangent to the front surface of the head stack at the centerline of the head gaps shall be perpendicular to the head-mounting plate within ± 3 minutes (± 0.87 mrad) of arc for low and intermediate-band recorders and ± 1 minute (± 0.29 mrad) of arc for wideband recorders. See Figure 6.

(6) Gap Scatter. Gap scatter shall be 0.0001 inch (0.003 mm) or less for $\frac{1}{2}$ inch (12.7 mm) tape and 0.0002 inch (0.005 mm) or less for 1 inch (25.4 mm) tape. See Figure 6 and Appendix F.

(7) Mean Gap Azimuth Alignment. The mean gap azimuth shall be perpendicular to the head-mounting plate to within ± 1 minute (± 0.29 mrad) of arc. See Appendix F.

(8) Head Location. Any head in a stack shall be located within ± 0.002 inch (± 0.05 mm) of the nominal position required to match the track location as shown in Figure 5.

(9) Head Interchangeability. Where rapid interchangeability of heads is specified, the method of head mounting, locating, and securing shall ensure that all alignment and location requirements are satisfied without shimming or mechanical adjustment, except for azimuth adjustment of the reproduce-head stack which may be required for intermediate-band recorder/reproducers and is required for wideband recorder/reproducers. Azimuth alignment of individual head gaps within a head stack shall be such that, when head-stack azimuth is adjusted for maximum output of any individual track at the upper band edge frequency, the outputs of the other tracks in the head stack shall be down no more than 2 db from their optimum azimuth setting.

c. Head Polarity. (See Chapter 3, 3-26 of IRIG 118-73 and Appendix F of this document.)

(1) Record Head. Each record-head winding shall be connected to its respective amplifier in such a manner that a positive-going pulse with respect to system ground, at the record amplifier input, will result in the generation of a specific magnetic pattern on a segment of tape passing the record head in the normal direction of tape motion. The resulting magnetic pattern shall consist of a polarity sequence of south-north north-south.

(2) Reproduce Head. Each reproduce-head winding shall be connected to its respective amplifier in such a manner that a segment of tape exhibiting a south-north north-south magnetic pattern will produce a positive-going pulse, with respect to system ground, at the output of the reproduce amplifier.

d. Tape Guiding. The tape guides shall restrict the tape angular motion to ± 1 minute (± 0.29 mrad) of arc as measured by the ITDE of outer tracks on the same head stack and shall not damage the tape.

e. Record/Reproduce Parameters. The high-frequency bias signal for low- and intermediate-band recorders shall have a wavelength on tape less than 60 microinches (1.524 μm). For wideband recorders the bias frequency shall be greater than 3.4 times the highest direct record frequency for which the recorder/reproducer system is designed. (See Appendix F).

NOTE

The frequency response or passband of direct-recorded data as a function of tape speed is given in Table 7. In measuring this response, signals throughout the specified passband are recorded at Normal Record Level and the reproduce output signal levels are referenced to the playback output at the Record Level Set Frequency. (See Appendix F)

f. Record Parameters.

(1) Input impedance at all frequencies in the low and intermediate bands shall be 5,000 ohms minimum resistance shunted by 250 picofarads maximum, with or without meter. Input impedance for the wideband recorders shall be 75 ohms ± 10 per cent across the specified band.

(2) Input signals of 1.0 to 10.0 volts peak-to-peak shall be adjustable to produce normal record level.

(3) The record amplifier shall provide a transfer characteristic which is basically a constant current versus frequency characteristic upon which is superimposed a compensation characteristic to correct only for loss of record head efficiency with frequency. For the test described in IRIG 118-73, the difference in the response curves normalized to the 0.02 upper band edge frequency shall be no greater than the figures given below:

Fraction of Upper Band Edge Frequency	db Difference
0.1	0.5
0.5	1.0
0.8	1.6
1.0	2.0

(4) Information for record bias setting is contained in Table 7.

(5) The level of recording shall be set at such a value that a reproduced signal of the Record Level Set Frequency indicated in Table 7 measured at the output of the playback amplifier under the load specified in paragraph 7-3 e. shall contain 1 per cent third harmonic distortion, (-40 ± 1 db referred to the output of a frequency 3 times the record level set

TABLE 7

Direct-Record Parameters

<u>Tape Speed</u> (ips)	<u>±3 db Pass Band</u> (Hz*)	<u>Record Bias</u> <u>Set Frequency</u> (KHz)	<u>Record Level</u> <u>Set Frequency</u> (KHz)
<u>Low Band</u>		(overbias 3 db**)	
60	100 – 100,000	100	10.0
30	100 – 50,000	50	5.0
15	100 – 25,000	25	2.5
7-1/2	100 – 12,000	12	1.2
3-3/4	100 – 6,000	6	0.6
1-7/8	100 – 3,000	3	0.3
<u>Intermediate Band</u>		(overbias 3db**)	
120	300 – 500,000	500	50.0
60	300 – 250,000	250	25.0
30	200 – 125,000	125	12.5
15	100 – 60,000	60	6.0
7-1/2	100 – 30,000	30	3.0
3-3/4	100 – 15,000	15	1.5
1-7/8	100 – 7,500	7.5	0.75
<u>1.5 Wideband</u>		(overbias 1 db**)	
120	400 – 1,500,000	1,500	150
60	400 – 750,000	750	75
30	400 – 375,000	375	37.5
15	400 – 187,000	187	18.7
7-1/2	400 – 93,000	93	9.3
3-3/4	– 46,000	46	4.6
<u>2.0 Wideband</u>		(overbias 2 db**)	
120	400 – 2,000,000	2,000	200
60	400 – 1,000,000	1,000	100
30	400 – 500,000	500	50
15	400 – 250,000	250	25
7-1/2	400 – 125,000	125	12.5
3-3/4	400 – 62,500	62.5	6.25

* Passband response reference is the output at the record level set frequency.

**Using an input signal level 5 to 6 db below normal record level, the record bias current is adjusted for maximum reproduce output and then increased until an output of the indicated db level below the maximum value is obtained.

frequency recorded at normal record level) such distortion being a function of tape saturation, and not a function of record or reproduce amplifier characteristics. This level, the Normal Record Level, is the zero db reference level for all other measurements. (In recording complex telemetry signals with varying crest factors, optimum record level must be determined for the particular signal to be recorded.)

g. Reproduce Parameters.

(1) Output impedance for low- and intermediate-band recording shall be 100 ohms maximum across the pass bands specified in Table 7. Output impedance for wideband recorders shall be 75-ohms maximum across the specified passband.

(2) When reproducing a signal at the record level set frequency recorded at an input voltage equivalent to that required for Normal Record Level, the output level shall be a minimum of 3 volts peak-to-peak with a maximum third harmonic distortion of 1.0 per cent and a maximum second harmonic distortion of $\frac{1}{2}$ per cent when measured across a resistive load of 600 ohms ± 10 per cent shunted by a maximum of 1500 picofarads for low-band and intermediate-band recorders. The output level shall be a minimum of 2 volts peak-to-peak with a maximum third harmonic distortion of 1.0 per cent and a maximum second harmonic distortion of $\frac{1}{2}$ per cent when measured across 75 ohms ± 10 per cent for wideband recorders. Lack of proper output termination shall not cause the reproduce amplifier to oscillate.

h. Tape Speed and Flutter Compensation. The average or long-term tape speed must be the same during record and reproduce to avoid frequency offsets which may result in erroneous data. To minimize this problem, a reference signal is applied to the tape during record and the signal is used to servo-control the tape speed upon reproduce. However, since servo reproduce systems have limited correction capabilities, and in order to minimize the amount of equipment required at the Ranges, tape speeds and servo-control signals are required to conform to the following standards:

(1) The effective tape speed throughout the reel or any portion of the reel (in the absence of tape derived servo speed control) shall be within ± 0.5 per cent of the standard speed for low-band recorders and ± 0.2 per cent for intermediate-band and wideband recorders as measured by the procedures described in IRIG 118-73.

(2) Sinusoidal speed-control signals are recorded on the tape for the purpose of servo control of tape speed during playback. Either type of speed-control signal, Amplitude-Modulated or Constant Amplitude, may be specified by the Range User. Operating level for speed-control signals shall be 10 ± 0.5 db below Normal Record Level, when mixed with other signals, or Normal Record Level when recorded on a separate track.

(a) The amplitude-modulated speed-control signal shall have the following characteristics:

Carrier frequency	17.0 KHz $\pm 0.5\%$
Bandwidth required	16,500 to 17,500 Hz
Percentage modulation	45% to 55%
Modulating frequency	60 Hz $\pm 0.01\%$

NOTE

FM Proportional Bandwidth Channel A or Constant Bandwidth Channel 1A cannot be used on the same track with the 17 KHz speed-control signal because it interferes with the speed-control signal.

(b) The constant-amplitude speed-control signal shall be used on a separate track for optimum servo speed correction. The constant-amplitude speed-control signal may be mixed with other signals if recording requirements so demand and system performance permits. Mixing of the constant-amplitude speed-control signal with certain types of signals may degrade system performance for tapes which are to be reproduced on tape transports with low time-base-error capstan drive systems (refer to manufacturer). Table 8 lists constant-amplitude speed-control signal frequencies and the bandwidth about the signal frequency which must be left free of other signals in order to give proper compensation operation. The constant-amplitude signal should also be used as a flutter correction signal if required.

(c) Signals to be used for discriminator flutter correction systems are listed in Table 4. See paragraph b. above for restrictions on use of flutter correction signals.

i. **Timing Signal Recording.** When recording IRIG-B modulated time-code signals, care must be taken to assure that low-frequency response to 100 Hz is provided. For low-band recorders direct-record response to 100 Hz is available. However, the direct-record low frequency cutoff of some intermediate-band and most wideband recorders is 400 to 500 Hz. For these systems, it is recommended that the Range time-code signals be recorded on an FM track or on an FM subcarrier. The highest subcarrier available should be employed to minimize time delay.

j. **Predetection Recording.** Predetection signals consist of frequency-modulated or phase-modulated intermediate-frequency carriers which have been translated in frequency to be compatible with wideband recorder frequency response. These signals will be recorded by direct (high-frequency bias) recording. Parameters for these signals are in Table 9.

7-4. Single Carrier FM Record and Wideband FM Record System

The input signal modulates a voltage-controlled oscillator, the output of which is delivered to the recording head.

- a. **Tape and Reel Characteristics.** Paragraph 7-3 a. and all subparagraphs shall apply.
- b. **Head and Head-Stack Configuration.** Paragraph 7-3 b. and all subparagraphs shall apply.
- c. **Tape Guiding.** Paragraph 7-3 d. shall apply.
- d. **Tape Speeds and Corresponding FM Carrier Frequencies.** See Table 10.
- e. **FM Record/Reproduce Parameters.** See Table 10.

TABLE 8

Constant-Amplitude Speed-Control Signals

Frequency (KHz)	Minimum Guard Band (Hz)*	Tape Speed ips (mm/s)**		Industry Standard
		Predetect	Postdetect	
200 ± 0.01%	± 13.950		60 (1524)	120 (3048)
100 ± 0.01%	± 10.500	120 (3048)	30 (762)	60 (1525)
50 ± 0.01%	± 2.500	60 (1524)	15 (381)	30 (762)
25 ± 0.01%	± 2.000	30 (762)	7.5 (190.5)	15 (381)
12.5 ± 0.01%	± 2.000	15 (381)	3.75 (95.2)	7.5 (190.5)
6.25 ± 0.01%	± 2.000	7.5 (190.5)	1.875 (47.6)	3.75 (95.2)
3.125 ± 0.01%	± 2.000	3.75 (95.2)		

*When using high performance servo systems, signals of higher frequency than the reference frequency should not be multiplexed with the reference signal. The level of individual extraneous signals, including spurious, harmonics, and noise, must be 40db or more below the level of the speed control signal.

**The listed tape-speed/frequency relationships are the ones most widely employed at the Ranges. Other combinations are used, but should be coordinated with the cognizant Range.

TABLE 9

PREDETECTION CARRIER PARAMETERS

Tape Speed ips (mm/s)	Predetection Carrier Center Frequency (KHz)	Recommended Predetection Record/ Playback Passband (KHz)
120 (3048)	900	100 to 1500.0
60 (1524)	450	50 to 750.0
30 (762)	225	25 to 375.0
15 (381)	112.5	12.5 to 187.5

TABLE 10
SINGLE-CARRIER AND WIDEBAND FM RECORD PARAMETERS

Low Band	Tape Speed ips (mm/s)	Intermediate Band	Wideband Group I	Carrier Center Frequency (KHz)	Carrier Deviation Limits*			Response at Band Limits (db)**
					Carrier Plus Deviation (KHz)	Carrier Minus Deviation (KHz)	Modulation Frequency (KHz)	
1 7/8 (47.6)				1.688	2.363	1.012	DC to 0.313	±1
3 3/4 (95.2)	1 7/8 (47.6)			3.375	4.725	2.025	DC to 0.625	±1
7 1/2 (190.5)	3 3/4 (95.2)			6.750	9.450	4.050	DC to 1.250	±1
15 (381)	7 1/2 (190.5)	3 3/4 (95.2)		13.50	18.90	8.100	DC to 2.500	±1
30 (762)	15 (381)	7 1/2 (190.5)		27.00	37.80	16.20	DC to 5.000	±1
60 (1524)	30 (762)	15 (381)		54.00	75.60	32.40	DC to 10.00	±1
	60 (1524)	30 (762)		108.0	151.2	64.80	DC to 20.00	±1
	120 (3048)	60 (1524)		216.0	302.4	129.6	DC to 40.00	±1
		120 (3048)		432.0	604.8	259.2	DC to 80.00	±1
			Wideband Group II**					
			3 3/4 (95.2)	28.125	36.562	19.688	DC to 12.50	+1, -3
			7 1/2 (190.5)	56.250	73.125	39.375	DC to 25.00	±1, -3
			15 (381)	112.50	146.25	78.750	DC to 50.00	±1, -3
			30 (762)	225.0	292.50	157.50	DC to 100.0	±1, -3
			60 (1524)	450.0	585.00	315.00	DC to 200.0	+1, -3
			120 (3048)	900.0	1170.0	630.0	DC to 400.0	+1, -3

* Input voltage levels per paragraph 7-4, e., (1).

** The second group of wideband FM carrier frequencies are primarily for use with predetection recorders where one or more FM analog channels are also required.

*** Frequency response referred to 1 KHz output for FM channels 13.5 KHz and above, and 100 Hz for channels below 13.5 KHz.

(1) For FM record systems, input voltage of 1.0 to 10.0 volts peak-to-peak shall be adjustable to produce full frequency deviation.

(a) Deviation Direction: Increasing positive voltage gives increasing frequency. Predetection recorded tapes are recorded with reverse deviation direction because of the frequency translation techniques employed. Care should be exercised when interchanging predetection tapes with conventional wideband FM systems.

(2) Single Carrier FM Record Systems. Minimum input impedance, 500 ohms resistance shunted by 250 pF capacitance.

(a) Wideband FM Record Systems: Input impedance 75 ohms \pm 10 per cent at all frequencies in the specified passband.

(3) FM Reproduce Systems. Output levels are for signals recorded at full deviation.

(4) Single-Carrier FM Systems. Three volts peak-to-peak minimum across a resistance of 10 kilohms minimum, from dc to the maximum specified frequency. A signal of increasing frequency on the input of a single-carrier or wideband FM reproduce system shall give a positive-going signal at the output.

(5) Wideband FM Systems. Two volts peak-to-peak minimum across a load impedance of 75 ohms \pm 10 per cent. Increasing input frequency gives a positive-going output voltage.

f. Speed Control and Compensation. Paragraph 7-3 h. shall apply noting that a separate track is always required for speed control and flutter compensation signals with single-carrier FM systems.

7-5. PCM Recording

PCM may be successfully recorded by several different methods. The major PCM recording formats in use are listed in Table 11.

7-6. Tape

See Chapter 8.

7-7. Parallel PCM

This section deals specifically with standards for recording PCM telemetry signals on 1 inch (25.4 mm) tape in parallel form. There are two standard systems - 16 and 31. The 31-track system consists of interleaved 16-track and 15-track stacks. The two stacks are employed as an independent record/reproduce system. Track spacing and location of tracks 1 through 16 in the 31-track system are identical to the 16-track system. Additional optional tracks A and B, located beyond tracks 1 and 16, may be used. Performance standards specified herein shall not apply to the optional tracks.

TABLE 11
PCM FORMATS

Method	Signal Type	Recording Format	
		Bit Placement	Electronic Mode
1	Predetection	Serial	Direct
2	Postdetection	Serial	Direct
3	Postdetection	Serial	FM
4	Postdetection	Parallel	Saturation
5	Postdetection	Serial	Saturation
6	Postdetection	Serial	High Density Digital

Methods 1 and 3 result in similar signals if the predetection carrier is in a PCM/FM form. Both are acceptable for serial recording prior to use of a bit synchronizer and signal conditioner.

Method 2 is acceptable if adequate provision is made for the lack of reproducer low-frequency response. Any method which adequately controls the low-frequency content of the signal may be used, e.g., constraint of format to insure an adequate number of transitions, or use of bi-phase modulation (See Chapter 4, Pulse Code Modulation (PCM) Standards). The last method is preferred but requires approximately double the bandwidth of NRZ modulation.

Method 4 is the only standard format for instrumentation parallel PCM recording after bit decisions have been made (i.e., after the data has become synchronous binary digital data).

Method 5 is not recommended unless several guard tracks can be placed between the saturated PCM track and the nearest analog track to minimize crosstalk from the saturated digital track.

Method 6, see Appendix F, subparagraph 1.c.

a. Track Geometry. See Figure 7.

(1) Track width for 16-track systems shall be 0.025 ± 0.002 inch (0.63 ± 0.05 mm). Track width is defined as the physical width of the head that would be used to record or reproduce any given track, although the actual width of the recorded track may be somewhat greater because of the magnetic fringing effect around each record head. Track width for optional tracks A and B for the 16-track systems shall be 0.010 ± 0.002 inch (0.25 ± 0.05 mm).

(2) Track width for 31-track systems shall be 0.020 ± 0.001 inch (0.50 ± 0.03 mm). Track width is defined as the physical width of the head that would be used to record or reproduce any given track, although the actual width of the recorded track may be somewhat greater because of the magnetic fringing effect around each record head. Optional tracks A and B, when employed, shall also be 0.020 ± 0.002 inch (0.50 ± 0.05 mm) in width.

(3) Spacing between track centers on 16-track systems shall be 0.060 inch (1.52 mm). Optional tracks A and B shall be centered 0.035 inch (0.88 mm) from the centerlines of tracks 1 and 16.

(4) Spacing between track centers on 31-track systems shall be 0.030 inch (0.76 mm) including optional tracks A and B.

(5) On 16-track systems, the center of the tape shall be centered between tracks 8 and 9.

(6) On 31-track systems, the center of the tape shall be centered on the centerline of track 24.

(7) For track numbering see Figure 7.

NOTE

Paragraph 7-3 a(2)(c) shall apply for 16 and 31-track systems, except that for 31-track systems the numbering from top to bottom shall be A (optional) 1, 17, 2, 18, 3, 19, ...31, 16 B (optional).

b. Head and Head-Stack Configuration See Figure 8.

(1) Paragraph 7-3 b.(2) shall apply for head-stack placement (31-track system).

(2) Paragraph 7-3 b.(3) shall apply for head-stack numbering (31-track system).

(3) Heads shall be numbered to correspond to the track on the tape that they normally record or reproduce. For 31-track systems, stack number 1 of a pair will contain heads numbered 1 through 16, and stack number 2 will contain heads numbered 17 through 31, and optionally, tracks A and B.

(4) Mean Gap azimuth error shall not exceed $\pm 1/3$ minute ($\pm 97 \mu\text{rad}$) of arc.

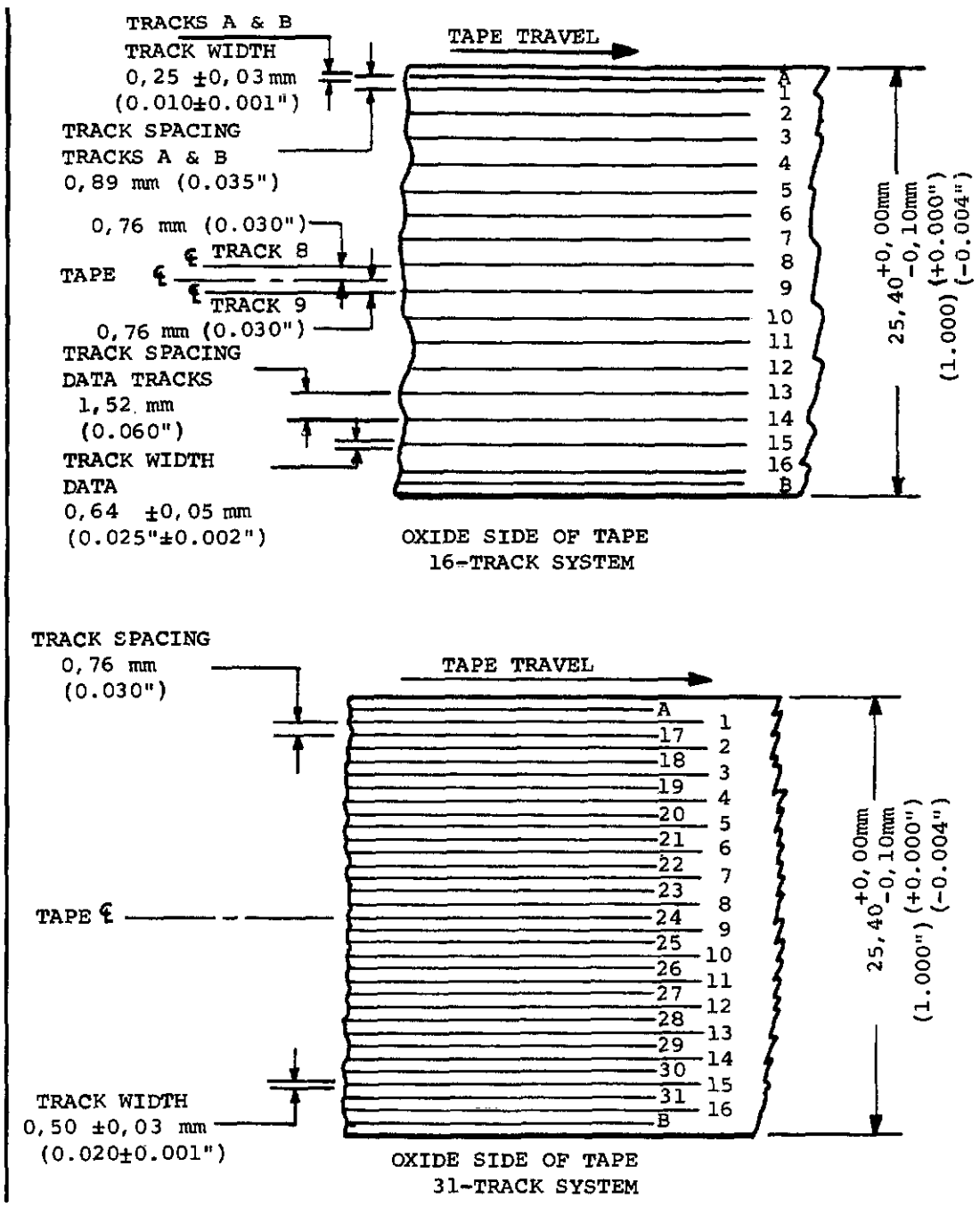
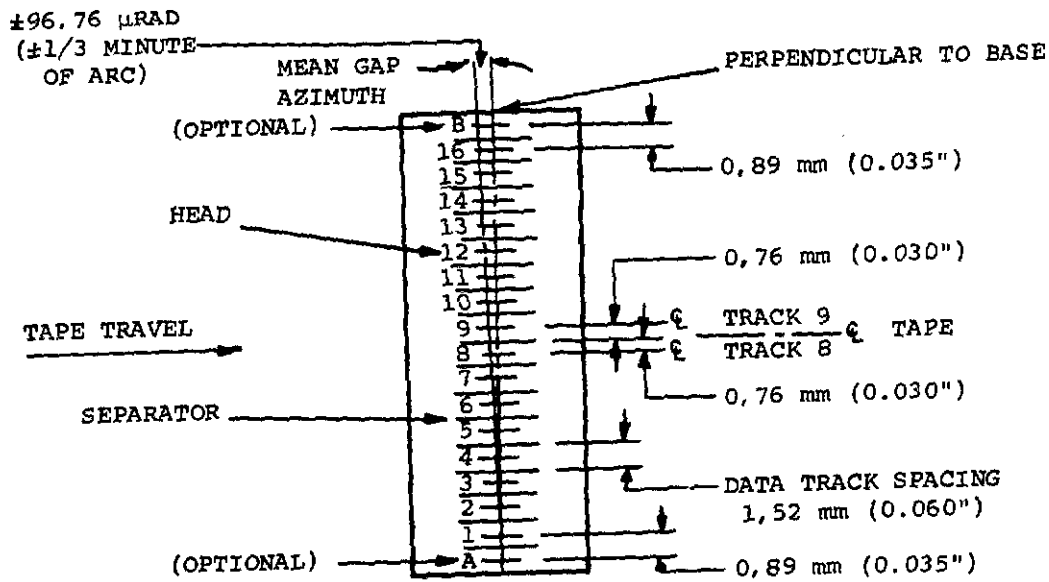

FIGURE 7. PCM TRACK SYSTEM.



16-TRACK SYSTEM

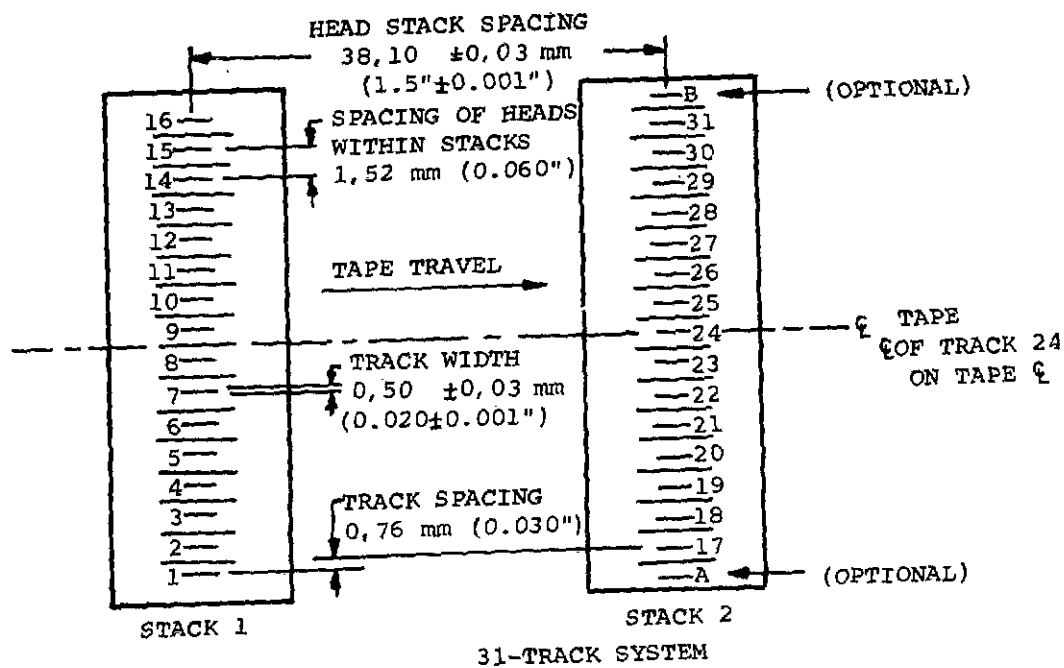

FIGURE 8. PCM HEAD CONFIGURATION.

(5) Paragraph 7-3 b.(5) shall apply for head-stack tilt.

(6) Paragraph 7-3 b.(6) shall apply for gap scatter.

(7) The location of any head in a stack shall be within ± 0.001 inch (± 0.03 mm), nonaccumulative, of the nominal position required to match the track location, as set forth in b.(1),(2), (3),(4),(5), and (6) above.

c. Head Polarity. Paragraph 7-3 c. shall apply.

d. Tape Guiding. Tape guides shall provide accurate guidance of the tape across the heads without damaging the tape.

e. Tape Speeds. Paragraph 7-2 a. shall apply.

f. Bit-Packing Density. The playback device shall be capable of playing back data recorded at bit-packing densities of 1000 bits per linear inch (39.37 bits/mm) per track maximum. The nominal maximum bit-packing density at the test ranges shall be 1000 bits per linear inch (39.37 bits/mm) per track.

g. Total Bit Spacing Error. This shall not exceed 650 microinches ($16.51 \mu\text{m}$), peak-to-peak with respect to the clocks, from record to reproduce and from machine to machine.

h. Type of Recording. Nonreturn-to-zero (NRZ) mark recording shall be employed wherein a change in magnetization of the tape from maximum level of one polarity to maximum level of the opposite polarity is used to indicate the digit one, and no change in magnetization during a bit interval indicates a zero. Recorder/reproducer electronics shall be designed to meet the requirements of paragraphs j and k below.

i. Timing. Track 16 shall be reserved for range timing.

j. Recorder Input Characteristics.

(1) Input impedance shall be 20 kilohms resistive minimum, shunted by 250 picofarads maximum.

(2) Input voltage shall be 2-to-20 volts plus, minus, or symmetrical about ground, and polarity-selectable.

(3) Input format shall be parallel input, NRZ level.

k. Output Characteristics.

(1) Reproduce output format shall be parallel output, NRZ level. Reproducer output shall compensate for all recorder/reproducer induced time-displacement errors to within 5.0 per cent of the word interval, or 1.6 microseconds, whichever is greater.

REVISED NOVEMBER 1975

- (2) Output impedance shall be 100 ohms maximum.
- (3) Output voltage shall be 10 volts peak-to-peak minimum across 1.000 ohms resistance shunted by no more than 250 picofarads capacitance, one polarity for one, opposite polarity for zero, selectable polarity.

NOTE

Paragraphs 7-8., PDM Recording; 7-9., Record Amplifier; and 7-10., Reproduce Amplifier have been deleted due to lack of use. Ranges which have an established capability are encouraged to maintain it as long as current needs exist; however, application of other standards is recommended for new programs. It is recommended that the ranges not buy new equipment related to these paragraphs.

CHAPTER 8

MAGNETIC TAPE STANDARDS

Section I. INTRODUCTION

8-1. General

These standards define terminology, establish key performance criteria and reference test procedures for instrumentation magnetic tape which is used for telemetry data storage.

Section II. REFERENCE TAPE SYSTEM

8-2. Purpose

In order to establish, where practical, a set of test procedures which can be carried out independently and repeatedly on different manufacturers' tape transports with as little special equipment as possible, a centerline reference tape system should be established by the tape user. This reference tape system can be used to provide a centerline standard for aligning operational recorders for mission support, using the applicable setup procedures contained in Chapter 7 or when initiating a tape procurement, as outlined below.

8-3. Manufacturer's Centerline Tape

A Manufacturer's Centerline Tape (MCT) is a tape provided by a manufacturer, at the request of the tape user, in which all magnetic/electrical characteristics of the tape specified by the tape user duplicate the manufacturer's own true average (mean) production centerline within ± 0.5 db. These magnetic/electrical characteristics shall include, but not be limited to, bias level, record level, wavelength response and output at 10 mil (254 μ m) wavelength. The physical characteristics of the MCT shall also represent the manufacturer's average (mean) production centerline. The MCT shall be representative of all manufacturer's production tape delivered under any resultant contractual period. The manufacturer may incorporate any desired changes in the MCT and production tape at the conclusion of any contract or as specified by the tape user. Any such change will, however, necessitate the requalification of all centerline values as outlined in paragraph 8-5 of this chapter.

NOTE

The MCT shall be a full length tape of either $\frac{1}{2}$ (12.7 mm) or 1 inch (25.4 mm) width, wound on a $10\frac{1}{2}$ (266.7 mm) or 14 inch (355.6 mm) reel, or as designated by the tape user. The center one-third of the working tape length shall be used as the calibrated working area.

8-4. Manufacturer's Secondary Centerline Tape.

A manufacturer's secondary centerline tape (MSCT) is a tape provided by the manufacturer in lieu of an MCT. In the MSCT, one or more of the specified magnetic/electrical characteristics may depart from the centerline average by more than 0.5 db. All of the

specified magnetic/electrical characteristics of the MSCT shall be calibrated to the MCT or to the manufacturer's own true average (mean) production centerline and any departure from these centerline values shall be specified within ± 0.5 db. The physical characteristics of the MSCT shall, however, represent the manufacturer's average (mean) production centerline. All additional MCT requirements shall apply to the MSCT.

8-5. Centerline Performance Requirements.

The tape user procuring magnetic tape shall establish, to the greatest extent possible, the operational support requirements which the magnetic tape must satisfy. A tape recorder which meets both the requirements of Chapter 7 and the above determined operational requirements shall also be selected for use as a test recorder/reproducer. The tape user will then request from each appropriate tape manufacturer, two or more MCT's which meet the requirements of para 8-3. If these MCT's cannot be obtained, then a MSCT which meets the requirements of para. 8-4 will be an acceptable, but less desirable, alternate.

8-6. MCT/MSCT Use.

Using the MCT or MSCT, the tape user will perform all tests necessary to determine if its manufacturer's centerline performance values meet his operational/recorder requirements. All acceptable MCT's or MSCT's will be retained by the tape user for use as a reference in any subsequent acceptance test procedures performed in support of resultant contracts or contractual periods. A working reference tape (WRT), which has been calibrated to the MCT or MSCT, will be used as the actual working reference in the applicable testing procedures outlined in Chapter 3, Section V, IRIG 118-73.

8-7. Test Recorder/Reproducer.

A test recorder shall be designated for use in conjunction with the reference tape system during any magnetic tape procurement/testing program. The recorder or recorders selected shall meet the requirements of Chapter 7 and the operational requirements imposed upon the tape. For operating convenience, the test recorder/reproducer selected should be equipped with adjustable bias and record level monitor meters with readout in db units used in the applicable test procedures.

8-8. Test Recorder/Reproducer Requirements.

This standard describes the key requirements applicable to high resolution (HR) and standard resolution (SR) instrumentation magnetic tape. Limits are specified, where necessary, to standardize configurations and to establish the basic handling characteristics of the tape. The limits placed upon the remaining requirements must be determined by the tape user in light of the intended application and interchangeability requirements imposed on the tape. Table 17 contains IRIG Recommended Requirement Limits, which have been selected on the basis of having provided satisfactory performance in existing telemetry applications.

8-9 General Requirements

a. **Marking and Identification.** Identification markings shall appear on the reel flange and individual carton or can of each delivered tape. Tape reel and production information, as

specified below, shall be on a removable gummed label on the outer reel flange and on a permanently affixed label on the carton or can. Shipping containers shall be marked with the tape and reel identification and such production information as specified by the tape user.

(1) Tape and Reel. The Magnetic Tape shall be identified in the following format:

HR	1.0 (25.4)	500 (12700)		
SR	1.5 (38.1)	1000 (25400)	SCP-I	9200 (2804)
Basic Indicator	Base Thickness Indicator	Width Indicator	Reel Indicator	Length Indicator

(a) Basic Indicator. The basic indicator defines the general application of the specified tape. HR tape is for recording of 0.06 mil (1.52 μm) wavelengths or greater and SR tape is for recording of 0.2 mil (5.08 μm) wavelengths or greater.

(b) Base Thickness Indicator. The base thickness indicator is the nominal thickness of the polyester base material measured in mils (μm).

(c) Width Indicator. The width indicator is the nominal width of the tape measured in mils (μm) as specified in Table 13.

(d) Reel and Reel Type Indicator. The reel or reel type is identified in accordance with Federal Specification W-R-175.⁵

(e) Length Indicator. The length indicator is the designated minimum length of tape in feet (meters) as specified in Table 13.

(2) Production Identification. Production identification of the magnetic tape will be in the following format:

Vendor - Tape Type - Production Date - Production Code

(a) Vendor. Identification of company that manufactures and markets the tape.

(b) Tape Type. Vendor's identifying tape name.

(c) Production Date. Five digit number with first two digits indicating year of production and last three digits indicating day of production completion. For example, 70048 indicates production completed on the 48th day of 1970.

(d) Production Code. Unique code by which the vendor identifies, where applicable, the production batch, coater, slitter, and web position of the tape.

**TABLE 13
TAPE DIMENSIONS
TAPE LENGTH/BASE THICKNESS**

Designated/Minimum Length ft (m)	Nominal Base Thickness Mils (μm)	Nominal Reel Diameter in (mm)	Nominal Hub Diameter in (mm)
2500 (762)	1.5 (38.1)	10.5 (266.7)	4.5 (114)
3600 (1097)	1.0 (25.4)	10.5 (266.7)	4.5 (114)
4600 (1402)	1.0 (25.4)	10.5 (266.7)	4.5 (114)
5000 (1524)	1.5 (38.1)	14.0 (355.6)	4.5 (114)
7200 (2195)	1.0 (25.4)	14.0 (355.6)	4.5 (114)
9200 (2804)	1.0 (25.4)	14.0 (355.6)	4.5 (114)
10800 (3292)	1.0 (25.4)	15.0 (381.0)	4.5 (114)

TAPE WIDTH*

Designated Width in (mm)	Dimension in (mm)	Tolerance in (mm)
½ (12.7)	0.498 (12.65)	± 0.002 (± 0.05)
1 (25.4)	0.998 (25.35)	± 0.002 (± 0.05)

*See note on Figure 5.

b. Packaging. Each reel of magnetic tape shall be enclosed, as a minimum, by an individually sealed polyethylene wrapper packaged in an appropriate carton or can which provides support of the enclosed reel at the hub.

c. Wind. The tape shall be wound on the reel or hub with the oxide surface facing toward the hub unless otherwise specified by the tape user. When wound in this fashion, the front of the wound reel is defined as that flange which is visible when viewing the reel of tape with the loose end hanging from the viewer's right.

d. Reels and Hubs. Reels and hubs shall conform to the tape-user specified requirements of Federal Specification W-R-175.

e. Radial Clearance. The minimum radial clearance for all tape lengths shall be not less than 0.125 inch (3.175 mm). Radial clearance is defined as the difference in inches (millimeters) in radii between the outside layer of tape and the edge of the reel when the tape is wound at a tension of 6-to-10 ounces (1.67 N to 2.78 N) per ½ inch (12.7 mm) of tape width on a reel that meets the requirements of Federal Specification W-R-175.

f. Inflammable Materials. Inflammable materials, which will ignite from a match flame and when so ignited will continue to burn in a still carbon dioxide atmosphere, shall not be a part of the magnetic tape.

g. Toxic Compounds. Compounds which produce toxic effects in the environmental conditions normally encountered under operating and storage conditions defined in paragraph 8-11 b. shall not be part of the magnetic tape. Toxicity is defined as the property of a material which has the ability to do chemical damage to the human body. Highly toxic or corrosive compounds which are produced under conditions of extreme heat shall be identified and described by the manufacturer.

8-10. Detailed Requirements.

The test procedures cited in the following paragraphs are contained in IRIG 118-73.

8-11. General Characteristics

a. Dimensional Specifications. Magnetic tape shall be supplied on flanged reels in the standard lengths, widths, and base thickness as outlined in Table 13. Reel and hub diameters are taken from Federal Specification W-R-175.

b. Environmental Conditions. The tape shall withstand, with no physical damage or performance degradation, any natural combination of operating or non-operating conditions defined in sub-paragraphs (1) and (2). The test procedure outlined in Chapter 3, Section V, paragraph 3-56 a. IRIG 118-73, shall be used to determine compliance with this requirement.

(1) Operating Environmental Conditions.

Condition	Range
Temperature:	+40°F to + 105°F (277.6 K to 313.8 K)
Humidity:	25% to 95% RH
Barometric Pressure:	4.6 km (105 kN/m ² (sea level) to 84 kN/m ²) 15,000 feet (1050 millibars (sea level) to 840 millibars)

(2) Non-operating Environmental Conditions.

Condition	Range
Temperature:	-20° to + 125°F (244.3 K to 324.9 K)
Humidity:	5% to 100% non-condensing
Barometric Pressure:	15.2 km (105 kN/m ² (sea level) to 40 kN/m ²) 50,000 feet (1050 millibars (sea level) to 400 millibars)

c. Storage Life. The tape shall be sufficiently durable, that storage up to 12 months (31.56 Ms), in conditions not exceeding those specified in b. (2) above shall result in no detrimental effects to the tape. The test procedure outlined in Chapter 3, Section V, paragraph 3-57 IRIG 118-73, shall be used to determine compliance with this requirement.

d. **Bi-Directional Performance.** The magnetic/electrical performance of the tape shall remain constant, regardless of the longitudinal direction of tape movement during a record/reproduce process. The test procedure outlined in Chapter 3, Section V, para. 3-58, IRIG 118-73, shall be used to determine compliance with this requirement.

e. **Frictional Vibration.** The tape shall not exhibit frictional vibration which manifests itself in an audible squeal at any standard IRIG speed as the tape passes over the guides and heads of the test recorder/reproducer. Frictional vibration is defined as the random frequency and amplitude modulation which results when the tape passes over the guides and heads of a magnetic tape recorder.

f. **Scatterwind.** The tape shall be smoothly centerwound on the reel and hub so as to form an integral mass. There shall be no visible folds, shifts, spoking, or gaps between the tape layers. The edges of the wound tape shall be in a single plane with a minimum of roughness and with no protruding tape layers or groups of layers.

8-12. Physical Characteristics

a. **Yield Strength.** The one per cent offset yield point, the force at three per cent elongation and the breaking force of the tape when conditioned according to the procedures described in Chapter 3, Section V, para. 3-59 a(1), IRIG 118-73, shall not be less than the minimum values specified in Table 14. The test procedure outlined in Chapter 3, Section V, para 3-59 a, IRIG 118-73, shall be used to determine compliance with this requirement.

b. **Shock Tensile Strength.** A sample of tape, ½ inch (12.7 mm) in width, when conditioned according to the procedures described in Chapter 3, Section V, para. 3-59 b(1) IRIG 118-73, shall possess, as a minimum, the shock tensile strength specified in Table 14. Shock tensile strength is defined as the ability of the magnetic tape to resist, without breaking, a suddenly applied stress. The test procedure outlined in Chapter 3, Section V, para. 3-59 b, IRIG 118-73, shall be used to determine compliance with this requirement.

c. **Permanent Elongation.** A sample of tape, ½ inch (12.7 mm) in width, when conditioned according to the procedures described in Chapter 3, Section V, para 3-59 b(3)(a), IRIG 118-73, and stressed as described below, shall not exceed the percentage limits of permanent elongation specified in Table 14. Permanent elongation is defined as the difference between an initially measured unstressed tape length and a final tape length, expressed as a percentage of the unstressed tape length. The unstressed tape length is the measured distance between a point of clamping and a mark on the tape while the tape is under an applied tension of 50 grams (490 mN). The final length is the measured distance between the point of clamping and the same mark on the tape under an applied tension of 50 grams (490 mN) after the tape has undergone an applied tension of 5 pounds (22N) for a period of 180 minutes (10.8 ks), and thereafter a period of zero tension for 180 minutes (10.8 ks). The test procedure outlined in Chapter 3, Section V, para. 3-59 b(3), IRIG 118-73, shall be used to determine compliance with this requirement.

**TABLE 14
TAPE STRENGTH***

Base Thickness mils(μm)	Yield Strength pounds (N)	Shock Tensile Strength foot-pounds (J)	Permanent Elongation (per cent)
1.5 (38.1)	9.8 (43.6)	1.16 (1.570)	0.30
1.0 (25.4)	6.4 (28.5)	1.16 (1.570)	0.50

*Based on 1/2 in. (12.7 mm) tape width.

d. Humidity Stability (Cupping). A sample of tape, 1/2 inch in width, when conditioned according to the procedures described in Chapter 3, Section V, para. 3-59 c(1), IRIG 118-73, shall show no cupping in excess of 10 degrees (0.175 rad). Cupping is defined as the transverse curvature of a strip of tape viewed "end-on." The test procedures outlined in Chapter 3, Section V, para. 3-59 c, IRIG 118-73, shall be used to determine compliance with this requirement.

e. Flexibility. The flexibility of the tape when conditioned according to the procedures described in Chapter 3, Section V, para. 3-60 a, IRIG 118-73, shall not be less than the values specified in Table 15. Flexibility is defined as the ability of the tape to conform to a minimum radius of curvature when subjected to a force normal to the surface of the tape. The test procedure outlined in Chapter 3, Section V, para. 3-60, IRIG 118-73, shall be used to determine compliance with this requirement.

**TABLE 15
FLEXIBILITY**

Nominal Width inches (mm)	Base Thickness Mils (μm)	Deflection degrees (rad)
1/2 (12.7)	1.5 (38.1)	35° (0.611)
1/2 (12.7)	1.0 (25.4)	45° (0.785)

f. Layer-to-Layer Adhesion. A sample of tape, 1/2 inch (12.7 mm) in width, when conditioned according to the procedures described in Chapter 3, Section V, para. 3-61 a, IRIG 118-73, shall exhibit no sticking or layer-to-layer adhesion when being unwound from a tape pack. Layer-to-layer adhesion is defined as the tendency for one layer of tape to adhere to an adjacent layer in the same pack. The test procedure outlined in Chapter 3, Section V, para. 3-61, IRIG 118-73, shall be used to determine compliance with this requirement.

g. Fungus Resistance. The tape shall be sufficiently fungus resistant so that at least 2 of 3 test specimens are rated 0 to 1 as defined in MIL-I-631D. Each reel or hub of tape shall be tested completely wound. The test procedures outlined in MIL-I-631D shall be used to determine compliance with this requirement.

h. Electrical Resistance. The oxide coating of the tape shall be conductive, allowing minimum static charge build-up. When conditioned according to the procedures outlined in

Chapter 3, Section V, para. 3-62 a, IRIG 118-73, the electrical resistance of the oxide coating shall not exceed 100 megohms per square unit of area. The test procedure outlined in Chapter 3, Section V, para. 3-62, IRIG 118-73, shall be used to determine compliance with this requirement.

i. **Tape Abrasivity.** The abrasivity of the oxide side of the magnetic tape determines the rapidity with which head wear takes place on a recorder/reproducer. Although no absolute method of determining tape abrasivity has been developed, a means exists for accurately comparing the relative abrasivity of two test samples. It is therefore recommended that the tape user select a specific centerline tape that has exhibited satisfactory abrasive characteristics in normal operational use and employ this tape as an abrasivity reference in conjunction with the test procedure outlined in Chapter 3, Section V, para. 3-63, IRIG 118-73.

8-13. Magnetic/Electrical Characteristics

a. **Bias Level.** The bias level required by the magnetic tape shall not differ from the bias level requirements of the MCT by more than the amount specified by the tape user. The bias level of the tape is defined as the amount of high frequency record head input required to achieve the IRIG specified upper-band-edge signal suppression. The test procedure outlined in Chapter 3, Section V, para. 3-64, IRIG 118-73, shall be used to determine compliance with this requirement.

b. **Record Level.** The record level required by the magnetic tape shall not differ from the record level requirements of the MCT by more than the amount specified by the tape user. The record level of the tape is defined as the amount of record head input signal at 1/10 upper band edge frequency required to achieve the IRIG specified normal record level. The test procedure outlined in Chapter 3, Section V, para. 3-64 b., IRIG 118-73, shall be used to determine compliance with this requirement.

c. **Wavelength Response.** The output of the magnetic tape measured at the wavelength values listed in Table 16, shall not differ from the output of the MCT by more than the amounts specified by the tape user. Wavelength response requirements shall be specified in terms of output after having normalized the output to zero at the 10 mil (254 μm) wavelength.

TABLE 16
MEASUREMENT WAVELENGTHS Mils (μm)

High Resolution Tape		Standard Resolution Tape	
150	(3810)	300	(7620)
10	(254)	60	(1524)
1	(25.4)	10	(254)
0.5	(12.7)	1	(25.4)
0.25	(6.35)	0.5	(12.7)
0.125	(3.18)	0.25	(6.35)
0.10	(2.59)	0.2	(5.08)
0.08	(2.03)		
0.06	(1.52)		

The test procedure outlined in Chapter 3, Section V, para. 3-64 c., IRIG 118-73, shall be used to determine compliance with this requirement.

d. Output at 10 Mil Wavelength. The 10 mil (254 μm) wavelength output of the magnetic tape shall not differ from the 10 mil (254 μm) wavelength output of the MCT by more than the amount specified by the tape user. The test procedure outlined in Chapter 3, Section V, para. 3-64 c., IRIG 118-73, shall be used to determine compliance with this requirement.

e. Short Wavelength Output Uniformity. The short wavelength output of the magnetic tape shall be sufficiently uniform that a signal recorded and reproduced throughout the working tape length in either direction of longitudinal tape motion shall remain free from long-term amplitude variation to the extent specified by the tape user. Short wavelength output uniformity is defined as the ratio of the peak value of the highest amplitude signal recovered in the working tape length to the peak value of the lowest amplitude signal recovered in the working tape length. The test procedure outlined in Chapter 3, Section V, para. 3-64 d., IRIG 118-73, shall be used to determine compliance with this requirement.

f. Short Wavelength Instantaneous Non-Uniformity (Dropout). The instantaneous output non-uniformity (dropout) of a recorded signal which is caused by the magnetic tape shall not exceed the center track and edge track limits specified by the tape user on the basis of dropouts per 100 feet (30.48 m) of nominal working tape length. The nominal dropout count shall be determined by totalizing all the dropouts per track over the working tape length and dividing by the total number of 100 foot (30.48 m) intervals tested.

NOTE

Due to the natural tendency of the edge track to contain more dropouts than the center tracks, it is recommended that center tracks be used for critical data requirements and that more dropouts be allowed on the edge tracks. Refer to Table 17.

(1) An alternate method of specifying the allowable dropout count is to specify the maximum number per track for each 100 foot (30.48 m) interval tested. This method may be desired if critical data is recorded in specific areas of the working tape length.

(2) A dropout is defined as a 6.0 db reduction in output signal amplitude for a period of 10 microseconds, when recording and reproducing a short wavelength signal. Signal losses of 6.0 db or greater, which exceed the 10 microsecond time period, shall constitute a dropout count for each 10 microsecond time period occurring in the given signal loss. Center tracks are defined as those which are more than one track distant from either edge of the tape, i.e., tracks 2 through 6 of a 7-track system. Edge tracks are defined as those which are nearest to either edge of the tape, i.e., tracks 1 and 7 of a 7-track system. The test procedure outlined in Chapter 3, Section V, para. 3-64 e., IRIG 118-73, shall be used to determine compliance with this requirement.

g. Durability. The magnetic tape shall resist deterioration in magnetic/electrical performance due to wear of the coating surface. Signal losses caused by surface wear shall not occur in excess of the per pass limits specified in Table 18 for the first 35 passes.

TABLE 17

SUGGESTED TAPE REQUIREMENT LIMITS

Para. No.	Tape Requirement	Suggested Limit			
8-12, i.	Tape Abrasivity	No more than 2 times centerline reference tape			
8-13, a.	Bias Level	± 2.0 db			
8-13, b.	Record Level	± 2.0 db			
8-13, c.	Wavelength Response	Measurement Wavelength mils (μm)		HR Tape (db)	SR Tape (db)
		300	(7620)	N/A	± 1.5
		150	(3810)	± 1.0	N/A
		60	(1524)	N/A	± 1.0
		10	(254)	0	0
		1	(25.4)	± 1.0	± 1.0
		0.5	(12.7)	± 1.0	± 1.0
		0.25	(6.35)	± 1.5	± 1.5
		0.20	(5.08)	N/A	± 2.0
		0.125	(3.18)	± 2.0	N/A
		0.10	(2.54)	± 2.5	N/A
		0.08	(2.03)	± 2.5	N/A
		0.06	(1.52)	± 3.0	N/A
8-13, d.	Output at 10 mil Wavelength (254 μm)	± 1.5 db			
8-13, e.	Short Wavelength Output Uniformity	HR Tape		SR Tape	
		4.5 db		3.0 db	
8-13, f.	Dropouts per 100 ft. (30.48 m)	HR Tape 1 MHz Carrier at 120 ips (3048 mm/s)		SR Tape 400 KHz Carrier at 120 ips (3048 mm/s)	
		Center Track	Edge Track	Center Track	Edge Track
		10	40	20	25
8-13, h.	Modulation Noise	1 db maximum			

**TABLE 18
DURABILITY SIGNAL LOSSES**

Designated Tape Length ft (m)	Allowable Signal Losses (per pass) db
2500 (762)	2
3600 (1097)	2
4600 (1402)	2
5000 (1524)	2
7200 (2195)	3
9200 (2804)	3
10800 (3292)	4

Signal losses in excess of those limits specified above shall not occur during either a record, record/reproduce, or reproduce uninterrupted pass of the working tape length. A signal loss is defined as a reduction in signal amplitude of 3 db or greater for a time period of 3 through 10 seconds of a recorded and reproduced short wavelength signal. Where a continuous loss of signal of 3 db or greater exceeds the 10 second time period, a signal loss count shall be required for every sequential 10 second time period occurring in the given signal loss. The test procedure outlined in Chapter 3, Section V, para. 3-64 f, IRIG 118-73, shall be used to determine compliance with this requirement.

h. Modulation Noise. The high frequency amplitude modulation superimposed upon a recorded and reproduced signal by the magnetic tape shall not exceed the limits specified by the tape user. The test procedure outlined in Chapter 3, Section V, para. 3-64 g, IRIG 118-73, shall be used to determine compliance with this requirement.

i. Layer-to-Layer Signal Transfer. A signal resulting from layer-to-layer signal transfer shall be reduced in amplitude from the original signal a minimum of 40 db for 1.0 mil (25.4 μm) tape and 46 db for 1.5 mil (38.1 μm) tape. Layer-to-layer signal transfer is defined as the transfer of recording information from a layer of tape in wound reel which has been prerecorded to saturation, to an adjacent unrecorded layer of tape in the same reel. The test procedure outlined in Chapter 3, Section V, para. 3-64 h., IRIG 118-73, shall be used to determine compliance with this requirement.

j. Ease of Erasure. An erase field of 1000 oersteds (79.58 kA/m) shall effect at least a 60 db reduction in output amplitude of a previously recorded 1.0 mil (25.4 μm) wavelength signal. The test procedure outlined in Chapter 3, Section V, para. 3-64 i., IRIG 118-73, shall be used to determine compliance with this requirement.

k. Suggested Tape Requirement Limits. Table 17 lists the suggested tape limits to be used for instrumentation tape.

CHAPTER 9

TRANSDUCER STANDARDS

Section I. INTRODUCTION

9-1. General

The vast variety of transducers, currently available for use in telemetry systems, makes it impractical to develop a standard universally applicable to all transducers, except in the areas of terminology and definitions. Professional societies and similar groups have promulgated a number of standards and recommended practices pertaining to particular classes of transducers. These documents, which are referenced below, shall be used to the maximum extent possible, in order to achieve the goal of uniformity in the field of telemetry.

9-2. Terminology and Definitions

Terminology and definitions pertaining to transducers are contained in:

- a. "A Glossary of Range Terminology," RCC Document 104-64, Revised, Secretariat, Range Commanders Council, 1964.
- b. ISA Standard S37.1 "Electrical Transducer Nomenclature and Terminology" (1969) Instrument Society of America, 530 William Penn Place, Pittsburgh, Pa.

Section II. AVAILABLE DOCUMENTATION

9-3. Transducer Characteristics and Performance

The Instrument Society of America has published a number of documents dealing with specific transducer types. Additional documents are being prepared by committees of the Society. The published documents are subject to continuing review and users are urged to contact the Society for the most up-to-date printing.

Documents published to date pertaining to transducers with electrical output are as follows:

- a. RP 31.1 "Terminology and Specifications for Turbine-Type Flow Transducers," (Volumetric) 1961.
- b. RP 37.2 "Guide for Specifications and Tests for Piezoelectric Acceleration Transducers for Aerospace Testing," January 1964.
- c. S 37.3 "Specifications and Tests for Strain Gage Pressure Transducers," 1970.
- d. S 37.6 "Specifications and Tests of Potentiometric Pressure Transducers for Aerospace Testing," May 1967.

- e. ISA "Transducer Compendium" Second Edition, Part 1, Pressure Level, and Flow, Transducers, IFI/Plenum, New York, 1969.
- f. ISA "Transducer Compendium" Second Edition, Part 2, Motion, Dimension, Force and Torque and Sound Transducers, IFI/Plenum, New York, 1970.

APPENDIX A

FMG FREQUENCY MANAGEMENT
PLAN FOR UHF TELEMETRY BANDS

References:

- a. Military Communications-Electronics Board Memoranda: MCEB-M 92-65, 19 February 1965; 105-69, 24 Feb 69; and, 323-72 1 Aug 72.
- b. IRIG (RCC) Document, Telemetry Standards, Doc. 106-73.
- c. Sandia Laboratories Technical Memorandum, SC-TM-68-9, "Frequency Channel Selection Subject to Constraints," February 1968.
- d. Air Force Eastern Test Range/PAA Tech Staff Memo No. 71, ETV-TM-67-16, "Multiple-Link Reception Through Wideband Nonlinear Components," 31 March 1967.

1. **Purpose** - To provide guidelines for the most effective use of allocated UHF telemetry bands, 1435-1535 MHz and 2200-2300 MHz.
2. **Scope** - This plan is intended to be utilized as a guide by all managers and users of telemetry frequencies in the above bands, at National, Service, or other DOD test ranges/facilities.
3. **General** - Essential air-ground telemetering in connection with guided missile, upper air research, space, and aircraft flight testing in the past has been accommodated on a primary basis on 44 channels (500 KHz bandwidth) in the 225-260 MHz portion of the military communications band, 225-400 MHz. The Military Communications-Electronics Board (MCEB) directed DOD agencies remove all telemetering operations from this band by 1 January 1970. The frequency bands 1435-1535 MHz and 2200-2300 MHz have been allocated to satisfy displaced and/or future telemetering needs (Ref a). This plan has been devised for application where congestion of the allocated telemetry spectrum is expected to be a problem, i.e., at the National and Service Ranges and adjacent areas.

This plan is based primarily on information obtained as a result of empirical and theoretical analysis, judgements formulated on past experience, and on expectations of future requirements and equipment characteristics.

4. **UHF Telemetry Radio Frequency Assignments**

- a. It has been determined that air/space-ground telemetering must be restricted to the 1435-1535 MHz and 2200-2300 MHz bands, effective 1 January 1970, in order to permit unrestricted use of the 225-400 MHz military communications band.

- b. The band 1435-1535 MHz is nationally allocated for Government/non-Government

telemetry use for flight testing of manned and unmanned aircraft, missiles, and space vehicles of major components thereof on a shared basis and the 2200-2300 MHz band is allocated for Government fixed and mobile communications and telemetry on a co-equal basis.

c. Narrowband telemetry channel spacing will be increments of 1 MHz beginning with frequencies 1435.5 and 2200.5 MHz, respectively. These numbers will be used as the base from which all frequency assignments are to be made. Wideband channels are permitted and will be centered on the center frequency of narrowband channels. Accordingly, all telemetry equipment, whether for narrow, medium, or wideband channel application, must be capable of operating on any one MHz increment in the 1435-1535 MHz or 2200-2300 MHz band, without infringing upon adjacent bands.

5. Channel Bandwidth Definitions and Spacing Allocations

To satisfy various channel bandwidth requirements, the following definitions and spacing allocations will prevail.

- a. Narrowband Channel. A channel with a necessary bandwidth of 1 MHz or less.
- b. Mediumband Channel. A channel with a necessary bandwidth of more than 1 MHz but not greater than 3 MHz.
- c. Wideband Channel. A channel having a necessary bandwidth greater than 3 MHz but not greater than 10 MHz, the assignment of which is to be determined by the service involved and based on justifiable program requirements.

NOTE 1

Channel bandwidth criteria stated in 5a, b, and c above are equivalent to occupied bandwidths not exceeding 1.2, 3.2, and 10.2 MHz respectively, when being modulated, as measured in accordance with the guidelines outlined in RCC Document, "Telemetry Standards," at 60 db down from the unmodulated carrier power.

NOTE 2

Necessary bandwidth is defined as the minimum value of the occupied bandwidth sufficient to insure the transmission of information at the rate and with the quality required for the system employed, under specified conditions and for a given class of emission.

d. For the purpose of designating channels to satisfy the varying necessary bandwidths, the following normally will prevail. However, it is recognized that for certain requirements, operational flexibility may necessitate the use of channels centered on any narrowband center frequency within the allocated bands. Further, the necessary bandwidth used on any particular channel will be contained within the allocated telemetry band concerned.

(1) 1435-1535 MHz Band

(a) Narrowband Channel (Center Frequency). 1435.5-1534.5 MHz; in 1 MHz increments, e.g., 1435.5, 1436.5, 1437.5, etc.

(b) Mediumband Channel (Center Frequency). 1436.5-1532.5 MHz; in 3 MHz increments, e.g., 1436.5, 1439.5, 1442.5, etc.*

(c) Wideband Channel (Center Frequency). 1440.5-1520.5 MHz, in 10 MHz increments, e.g., 1440.5, 1450.5, 1460.5, etc.**

(2) 2200-2300 MHz Band

(a) Narrowband Channel (Center Frequency). 2200.5-2299.5 MHz; in 1 MHz increments, e.g., 2200.5, 2201.5, 2202.5, etc.

(b) Mediumband Channel (Center Frequency). 2201.5-2297.5 MHz; in 3 MHz increments, e.g., 2201.5, 2204.5, 2207.5, etc.*

(c) Wideband Channel (Center Frequency). 2205.5-2285.5 MHz, in 10 MHz increments, e.g., 2205.5, 2215.5, 2225.5, etc.**

*Center frequencies in this band are predicated on the basis that necessary bandwidth is 3 MHz in each case.

**Center frequencies in this band are predicated on the basis that necessary bandwidth is 10 MHz in each case.

6. Telemetry Frequency Assignment Guidance

The following information, which is based on the results of tests, theoretical analysis, and judgments based on past experience, should be used for the guidance of all concerned:

a. Geographical Separation. Two or more telemetry transmitters operating simultaneously on the same narrowband channel center frequency must be sufficiently separated geographically; otherwise degradation of data is likely to occur.

b. Simultaneous Operations. Two or more narrowband telemetry transmitters operating simultaneously on the same vehicle or in the same geographical area must be separated by a minimum of 1 MHz, to preclude degradation of data.

c. Multi-carrier Operations. If interference is to be precluded or minimized to the maximum extent possible, frequency selection must be made judiciously. Various systematic methods have been developed for selecting frequencies to accomplish this aim. The following are model or example sets derived for the selection of a maximum number of frequencies for simultaneous operations, precluding or minimizing third order intermodulation products:

(1) Model or Example No. 1:

1 MHz Bandwidth Assignments

- 2201.5 MHz
- 2202.5 MHz
- 2204.5 MHz
- 2208.5 MHz
- 2216.5 MHz
- 2232.5 MHz
- 2264.5 MHz

(2) Model or Example No. 2:

1 MHz Bandwidth Assignments
Using Even Spacing No.

- 2200.5 MHz
- 2202.5 MHz
- 2210.5 MHz
- 2224.5 MHz
- 2250.5 MHz
- 2254.5 MHz
- 2270.5 MHz
- 2282.5 MHz
- 2288.5 MHz

1 MHz Bandwidth Assignments
Using Odd and Even Spacing No.

- 2200.5 MHz
 - 2201.5 MHz
 - 2206.5 MHz
 - 2210.5 MHz
 - 2223.5 MHz
 - 2226.5 MHz
 - 2234.5 MHz
 - 2241.5 MHz
 - 2253.5 MHz
 - 2255.5 MHz
- (Selections beyond this point have not been determined due to the computations necessary. However, it will be noted that this is the most efficient selection of frequencies of the examples given.)

NOTE

The above selections do not necessarily reflect all combinations possible but are offered only as examples of some which have been ascertained as representative possibilities. Methods and/or programs have been developed by Sandia and the AFETR (Ref c and d), among others, which are available upon request.

It can be seen that the frequency spacing in the above examples has avoided (1) duplication of identical frequency spacing and (2) adjacent frequency spacings that can be added to equal any other frequency spacing or sum of adjacent frequency spacings. For example:

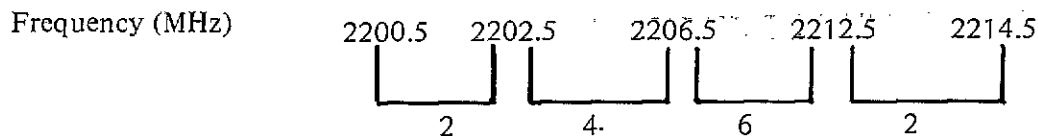

There are duplicate spacings of 2 MHz each and there will be intermodulation between frequencies 2200.5, 2202.5, 2212.5, and 2214.5 MHz.

Spacings $2 + 4 = 6$, and there will be interference between 2200.5, 2206.5, and 2212.5 MHz.

NOTE

The above group of five frequencies has intermodulation problems and would be a poor choice of frequencies.

d. To minimize interference, a maximum of ten narrowband channels (1 MHz bandwidth or less) may be used simultaneously on the same vehicle/source, within either of the two UHF telemetry bands, if their spacing is identical to the example in c(2) above.

e. To preclude interference and overcrowding of the spectrum allocated for telemetry, to the maximum extent possible, use should be made of both UHF bands, 1435-1540 MHz and 2200-2300 MHz.

7. STANDARDS FOR THE LEVEL OF UNDESIRE EMISSIONS OUTSIDE THE AUTHORIZED BANDWIDTH FOR TELEMETERING STATIONS, EXCLUDING THOSE FOR SPACE RADIOCOMMUNICATION, IN THE BANDS 1435-1535 AND 2200-2290 MHz.

7-1. General

These standards are applicable to telemetering stations, excluding those for radiocommunication, authorized for operation in the bands 1435-1535 and 2200-2290 MHz. Assignments to such stations include an assigned frequency and an authorized bandwidth centered on that frequency. The authorized bandwidth is identical to the emission bandwidth, which is indicated by the numerical prefix to the emission designators in the list of Frequency Assignments to Government Radio Stations, and to the *necessary bandwidth. These standards are applicable independently of and are not related to any present or future channelization of these bands.

**As defined by the ITU Radio Regulations and Section 6.1.1 of this Manual: For a given class of emission, the minimum value of the occupied bandwidth sufficient to ensure the transmission of information at the rate and with the quality required for the system employed, under specified conditions. Emissions useful for the good functioning of the receiving equipment as, for example, the emission corresponding to the carrier of reduced carrier systems, shall be included in the necessary bandwidth.*

7-2. Definitions

P_T = Transmitter power in watts (unmodulated carrier)

BW = Bandwidth

Authorized BW = Emission BW = Necessary BW, in MHz

F_o = Center of BW

A and A' = BW to which all emissions must, as a minimum, be suppressed 60 dB or to -25 dBm, whichever is greater.

B and B' = BW to which all emissions must, as a minimum, be suppressed in dB, $55 + 10 \log_{10} P_T$.

7-3. Standard for Authorized Bandwidth Equal to or Less Than 1 MHz

A. On each side of F_o :

$$\text{Let } \frac{A}{2} = \frac{\text{Authorized BW}}{2} + \frac{\text{Authorized BW}}{2}$$

Then $A = 2 \times \text{Authorized BW}$.

Power Level Limit: In any 3 kHz bandwidth outside bandwidth A, the minimum required attenuation for all emissions is 60 dB below P_T , except that it shall not be necessary in any case to attenuate below a level of -25 dBm.

B. On each side of F_o :

$$\text{Let } \frac{B}{2} = \frac{A}{2} = 0.5 \text{ MHz.}$$

Then $B = (2 \times \text{Authorized BW}) = 1.0 \text{ MHz}$.

Power Level Limit: In any 3 kHz bandwidth outside bandwidth B, the minimum attenuation for all emissions must be in accordance with the following formula:

$X = -60 \text{ dB}$ or to -25 dBm , whichever is greater.

$Y \text{ (in dB)} = -(55 + 10 \log_{10} P_T)$.

NOTE

This limits the maximum power level outside B to -25 dBm.

EXAMPLE 1:

Assume an Authorized BW of 0.4 MHz centered on F_0 :

$$\begin{aligned}
 A &= 2 \times \text{Authorized BW} & B &= (2 \times \text{Authorized BW} + 1.0 \text{ MHz}) \\
 &= 2 \times 0.4 & &= (2 \times 0.4) + 1.0 \\
 &= 0.8 \text{ MHz} & &= 1.8 \text{ MHz}
 \end{aligned}$$

The illustration below shows the power level limit:

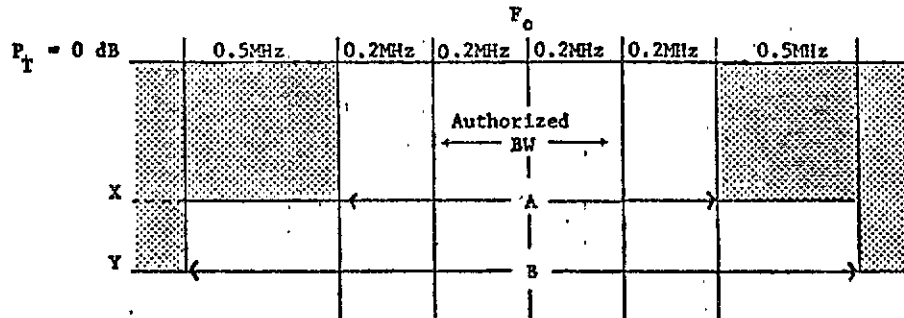

7-4. Standard for Authorized Bandwidth Greater Than 1 MHz

A. On each side of F_0 :

$$\text{Let } \frac{A}{2} = \frac{\text{Authorized BW}}{2} + 0.5 \text{ MHz.}$$

$$\text{Then } A' = \text{Authorized BW} + 1.0 \text{ MHz.}$$

Power Level Limit: In any 3 kHz bandwidth outside bandwidth A' , the minimum required attenuation for all emissions is 60 dB below P_T , except that it shall not be necessary in any case to attenuate below a level of -25 dBm.

B. On each side of F_0 :

$$\text{Let } \frac{B'}{2} = \frac{A'}{2} + 0.5 \text{ MHz}$$

$$\text{Then } B' = (\text{Authorized BW}) + 2.0 \text{ MHz.}$$

Power Level Limit: In any 3 kHz bandwidth outside bandwidth B' , the minimum attenuation for all emissions must be in accordance with the following formula:

$$X = -60 \text{ dB or to } -25 \text{ dBm, whichever is greater.}$$

$$Y \text{ (in dB)} = -(55 + 10 \log_{10} P_T).$$

NOTE

This limits the maximum power level outside B' to -25 dBm.

EXAMPLE 2:

Assume an Authorized BW of 1.5 MHz centered on F_0 :

$$\begin{aligned} A' &= \text{Authorized BW} + 1.0 \text{ MHz} \\ &= 1.5 + 1.0 \\ &= 2.5 \text{ MHz} \end{aligned}$$

$$\begin{aligned} B' &= \text{Authorized BW} + 2.0 \text{ MHz} \\ &= 1.5 + 2.0 \\ &= 3.5 \text{ MHz} \end{aligned}$$

The illustration below shows the power level limit:

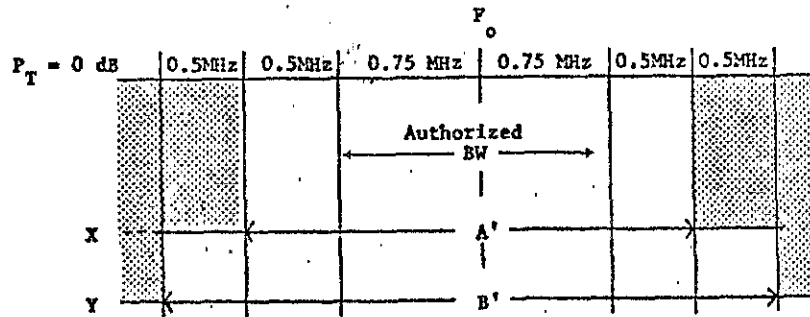

NOTE

(Material in paragraph 7. taken from the OTP Manual of Regulations and Procedures for Radio Frequency Management - September 1974.)

APPENDIX B

USE CRITERIA FOR FREQUENCY DIVISION MULTIPLEXING

1. General

The successful application of the Frequency Division Multiplexing Telemetry Standards depends upon recognition of performance limits and performance tradeoffs which may be required in implementation of a system. The use criteria included in this appendix are offered in this context, as a guide for orderly application of the standards which are presented in Chapter 3.

It is the responsibility of the telemetry system designer to select the range of performance that will meet his data measurement requirements and at the same time permit him to operate within the limits of the standards. A designer or user must also recognize the fact that even though the standards for FM/FM multiplexing encompass a broad range of performance limits; tradeoffs such as data accuracy for data bandwidth may be necessary. Nominal values for such parameters as frequency response and rise time are listed to indicate the majority of expected use, and should not be interpreted as inflexible operational limits. It must be remembered that system performance is influenced by other considerations such as hardware performance capabilities. In summary, the scope of the standards together with the use criteria are intended to offer flexibility of operation and yet provide realistic limits.

2. FM Subcarrier Performance

The nominal and maximum frequency response of the subcarrier channels listed in Tables 2 and 3 is 10 per cent and 50 per cent, respectively, of the maximum allowable deviation bandwidth. The nominal frequency response of the channels employs a deviation ratio of five. The deviation ratio of a channel is defined as one-half the defined deviation bandwidth divided by the cutoff frequency of the discriminator output filter.

The use of other deviation ratios for any of the subcarrier channels listed may be selected by the Range Users to conform with the specific data response requirements for the channel. As a rule, the rms signal/noise ratio of a specific channel varies as the three-halves power of the subcarrier deviation ratio employed.

The nominal and minimum channel rise times indicated in Tables 2 and 3 have been determined from the equation which states that rise time is equal to 0.35 divided by the frequency response for the nominal and maximum frequency response, respectively. The equation is normally employed to define the 10 to 90 per cent rise time for a step function of the channel input signal; however, deviations from these values may be encountered due to variations in subcarrier components in the system.

3. FM Subcarrier Performance Tradeoffs

The number of subcarrier channels which may be used simultaneously to modulate a radio-frequency carrier is limited by the radio-frequency channel bandwidth, and by the output signal/noise ratio that is acceptable for the application at hand. As channels are added, it is necessary to reduce the transmitter deviation allowed for each individual channel, to keep the overall multiplex within the radio-frequency channel assignment. This lowers the subcarrier-to-noise performance at the discriminator inputs, and the system designer's problem is to determine acceptable tradeoffs between the number of subcarrier channels and acceptable subcarrier-to-noise ratios.

Background information relating to the level of performance and the tradeoffs that may be made is included in the "Telemetry FM/FM Baseband Structure Study," Volumes I and II, DDC Documents AD-621139 and AD-621140, which were completed under a contract administered by the Telemetry Working Group of IRIG. The results of the study show that proportional bandwidth channels with center frequencies up to 165 KHz and constant-bandwidth channels with center frequencies up to 176 KHz may be used within the constraints of these standards. The test criteria included the adjustment of the system components for approximately equal signal-to-noise ratio at all of the discriminator outputs with the receiver input near radio frequency threshold. Intermodulation caused by the radio link components carrying the composite multiplex signal limits the channel's performance under large signal conditions.

With subcarrier deviation ratios of four, channel data errors on the order of 2.0 per cent rms were observed. Data channel errors on the order of 5.0 per cent rms of full-scale bandwidth were observed when subcarrier deviation ratios of two were employed. When deviation ratios of one were used, it was observed that channel data errors exceeded 5.0 per cent. Some channels showed peak-to-peak errors as high as 30 per cent. It must be emphasized, however, that the results of the tests performed in this study are based upon specific methods of measurement on one system sample and that this system sample represents a unique configuration of components. Other components with other performance characteristics will not necessarily yield the same system performance.

System performance may be improved, in terms of better data accuracy, by sacrificing system data bandwidth. That is, if the user is willing to limit the number of subcarrier channels in the multiplex, particularly the higher frequency channels, the input level to the transmitter can be increased. The signal-to-noise ratio of each subcarrier is then improved through the increased per-channel transmitter deviation. For example, the baseband structure study indicated that when the 165 KHz channel and the 93 KHz channel were not included in the proportional bandwidth multiplex, performance improvement in the remaining channels equivalent to approximately 12 db increased transmitter power can be expected.

Likewise, elimination of the five highest frequency channels in the constant-bandwidth multiplex allowed a 6 db increase in performance.

A general formula which can be used to estimate the thermal noise performance of an FM/FM channel above threshold⁶ is as follows:

$$\left(\frac{S}{N}\right)_d = \left(\frac{S}{N}\right)_c \left(\frac{3}{4}\right)^{1/2} \left[\frac{B_c}{F_{ud}}\right]^{1/2} \left(\frac{f_{dc}}{f_s}\right) \left(\frac{f_{ds}}{F_{ud}}\right)$$

where

$$\left(\frac{S}{N}\right)_d = \text{discriminator output signal-to-noise ratio (rms voltage ratio)}$$

$$\left(\frac{S}{N}\right)_c = \text{receiver carrier-to-noise ratio (rms voltage ratio)}$$

$$B_c = \text{carrier bandwidth (receiver intermediate-frequency bandwidth)}$$

$$F_{ud} = \text{subcarrier discriminator output filter - 3 db frequency}$$

$$f_s = \text{subcarrier center frequency}$$

$$f_{dc} = \text{carrier peak deviation due to the particular subcarrier of interest}$$

$$f_{ds} = \text{subcarrier peak deviation}$$

If the RF carrier power is such that the thermal noise is greater than the intermodulation noise, the above relation provides estimates accurate to within a few decibels.

The FM/FM composite multiplex signal used to modulate the radio-frequency carrier may be a proportional-bandwidth format, a constant-bandwidth format, or a combination of the two types provided only that guard bands allowed for channels used in a mixed format be equal to or greater than the guard band allowed for the same channel in an unmixed format.

4. FM System Component Considerations

System performance is dependent upon essentially all components in the system. Neglecting the effects of the radio-frequency and recording system, data channel accuracy is primarily a function of the linearity and frequency response of the subcarrier oscillators and discriminators employed. Systems designed to transmit data frequencies up to the nominal frequency responses indicated in Tables 2 and 3 have generally well-known response capabilities, and reasonable data accuracy estimates can be easily made. For data channel requirements approaching the maximum frequency response of Tables 2 and 3, oscillator and discriminator characteristics are less consistent and less well defined, making data accuracy estimates less dependable.

The effect of the radio-frequency system on data accuracy is primarily in the form of noise due to intermodulation at high radio-frequency signal conditions well above threshold. Under low radio-frequency signal conditions, noise on the data channels is increased due to the degraded signal-to-noise ratio existing in the receiver.

Intermodulation of the subcarriers in a system is due to characteristics such as amplitude and phase nonlinearities of the transmitter, receiver, or other system components required to handle the multiplex signal under the modulation conditions employed. In systems employing pre-emphasis of the upper subcarriers, the lower subcarriers may experience intermodulation interference due to different frequencies of the high-frequency (and high-amplitude) channels.

The use of magnetic tape recorders for recording a subcarrier multiplex may degrade the data channel accuracy, primarily due to tape speed differences or variations between recording and playback. These speed errors can normally be compensated for in present discriminator systems when the nominal response rating of the channels is employed and a reference frequency is recorded with the subcarrier multiplex.

5. Range Capability for FM Subcarrier Systems

a. Receivers and Tape Recorders

The use of the 93, 124, and 165 KHz proportional channels or the corresponding constant-bandwidth channels may require discriminators or tape recorders of a greater capability than are in current use at some ranges. It is recommended that users who anticipate employing any of the above channels at a range, check the range's capability at a sufficiently early date to allow procurement of necessary equipment.

b. Discriminator Channel Selection Filters

Inclusion of the higher frequency proportional-bandwidth channels and the constant-bandwidth channels will require the ranges to acquire additional band selection filters. In applications where minimum time delay variation within the filter is important, such as tape speed compensation, or high rate PAM or PCM, constant-delay filter designs are recommended.

c. Discriminator Output Filters

If a range facility were to stock discriminator output filters corresponding to each of the channel frequency responses listed in Tables 2 and 3, it would be necessary to accommodate 64 separate cutoff frequencies. This number must be multiplied if more than one roll-off stop is required. In order to place a more modest requirement on the range facilities, output filters with the following cutoff frequencies are recommended.

A filter for each of the frequencies listed under nominal frequency response in Table 3 plus 6500, 8500, 11,000, 19,000, and 24,000 Hz. In addition, filters are recommended corresponding to each of the nominal and maximum frequency responses listed in Table 3. For other data frequency requirements, compromises should be made by selecting one of the filter frequencies already listed.

NOTE

Paragraphs 6, AM Subcarrier Background, 7., AM Airborne Systems, 8., AM Ground System, and 9., Tape Recording, have been deleted due to lack of use. Ranges which have an established capability are encouraged to maintain it as long as current needs exist; however, application of other standards is recommended for new programs. It is recommended that the ranges not buy new equipment related to these deleted paragraphs.

APPENDIX C

PCM STANDARDS

ADDITIONAL INFORMATION AND RECOMMENDATIONS

1. Bit Rate Versus Receiver Intermediate-Frequency Bandwidth (3 dB Points)

a. Receiver intermediate-frequency (IF) bandwidth should be selected from those values listed in Table 6. Only those discrete receiver intermediate-frequency bandwidths listed should be used for data channel (optional below 12,500 Hz). The selections in Table 6 have been made on the consideration that automatic tracking of radio-frequency (RF) carrier drift or shift will be used in the receiver; however, doppler shift considerations may require wide intermediate-frequency/discriminator bandwidths for the AFC system.

b. For reference purposes in a well designed system, a receiver intermediate-frequency signal-to-noise ratio (power) of approximately 15 dB will result in a bit error probability of about 1 bit in 10^6 . A 1 dB change (increase or decrease) in this signal-to-noise ratio will result in an order of magnitude change (10^7 or 10^5 from 10^6 , respectively) in the bit error probability.

c. It is recommended that the period between assured bit transitions be a maximum of 64-bit intervals to assure adequate bit synchronization.

2. Suggested PCM Synchronization Patterns

It is suggested that an N-bit frame-synchronization pattern be selected under the criterion that the probability of displacement of the pattern by ± 1 bit be minimized at the same time, restricting the probability of pattern displacement by 2 to (N-1) bits below a prescribed maximum. A 31-bit synchronization pattern satisfying this criterion is 0101011010100101101001101010111.

3. Premodulation Filtering

Paragraph deleted.

4. Spectral Comparisons for NRZ, BIØ, and DM

Plotted in Figure C-1 are the power spectral densities of NRZ, BIØ, and DM coding. Plotted in Figure C-2 are the theoretical BER vs

SNR curves for NRZ, BIØ, and DM coding. The spectral properties of DM coding which make it attractive for magnetic tape recording include:

- a. The majority of the signaling energy lies in frequencies less than one half the bit rate.
- b. The spectrum is small at $f=0$. This spectral minimum facilitates the problem of bit synchronization.
- c. A reduced power spectral density in the vicinity of $f=0$ is important in tape recording because tape response is poor at low frequencies.
- d. As a result of subparagraphs 4.a and 4.b above, higher bit packing density can be used.
- e. The NRZ-L code is insensitive to the 180° phase ambiguity that is common to DM and BIØ coding.
- f. RF transmission of DM formats must consider an approximate 3.5 dB SNR penalty (See report identified in the following note).

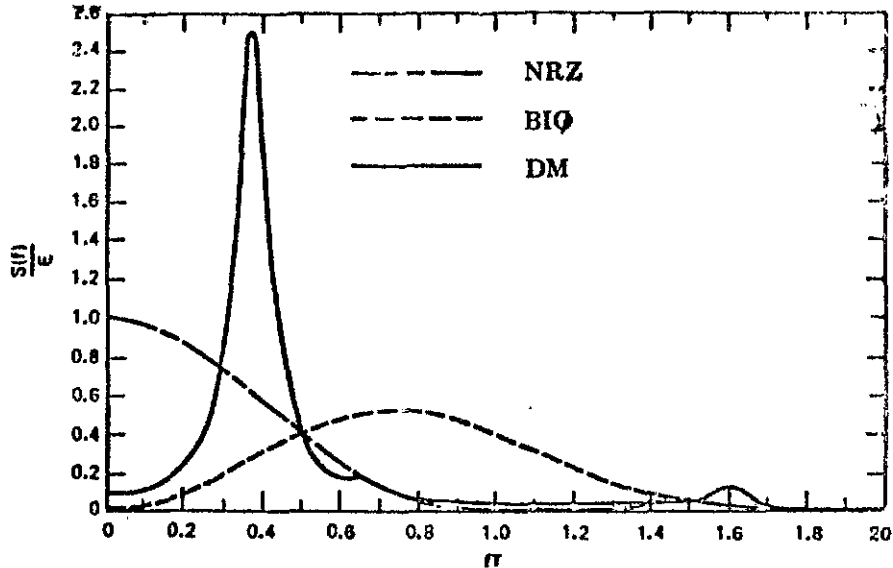

Figure C-1. Spectral Density of Random NRZ, BIØ, and DM Coding

$S(f)/E$ is power spectral density normalized with respect to signal energy per bit.
 f is frequency.
 T is bit period.

NOTE

Material presented in paragraph 4 is taken from Naval Missile Center Technical Publication TP-73-18; Bit Synchronization System Performance Characterization, Modeling, and Tradeoff Study; by W. C. Lindsey, University of Southern California.

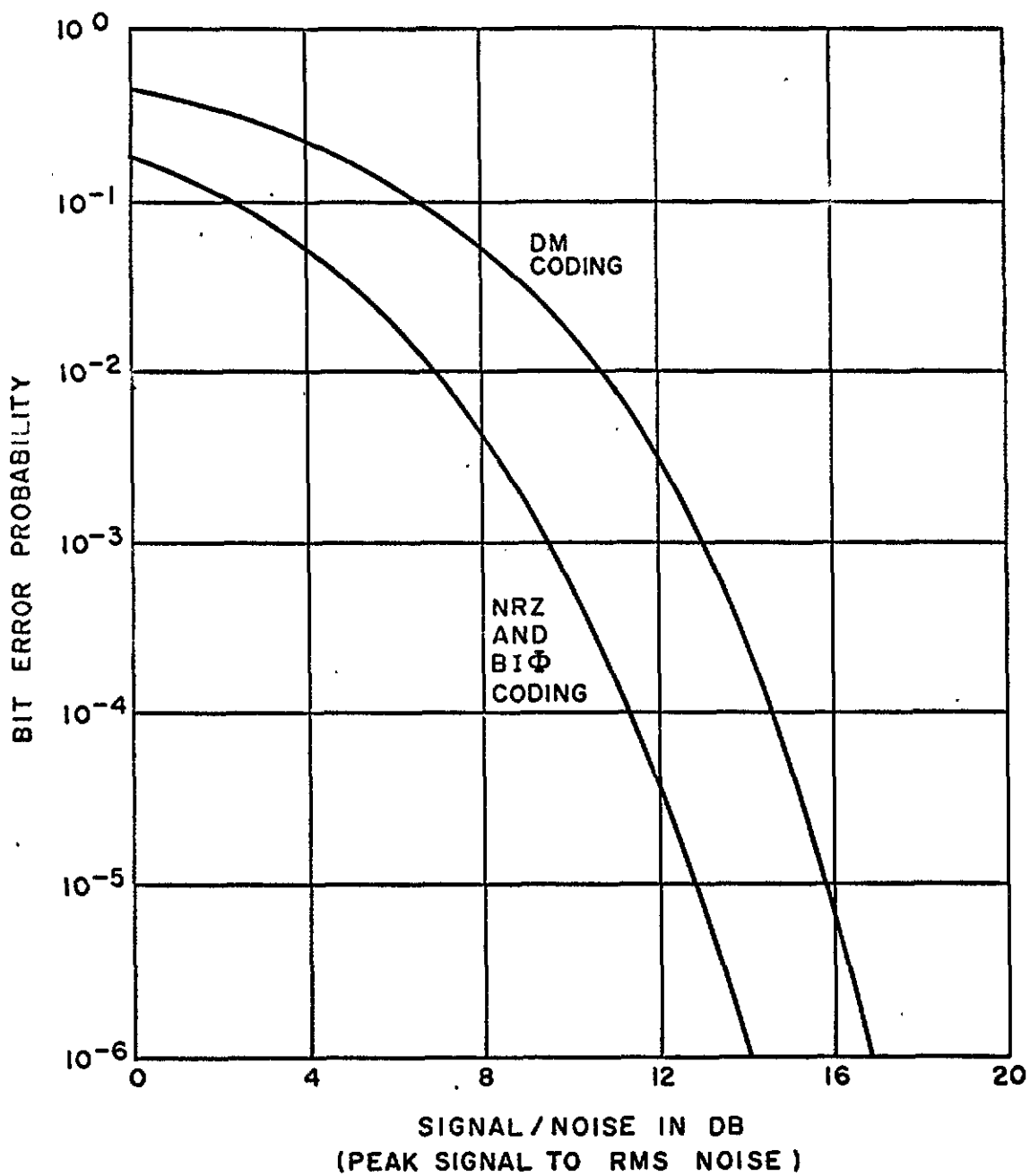

Figure C-2. Theoretical BEP Performance for Various Baseband PCM Signaling Techniques (perfect bit assumed).

APPENDIX D

PAM STANDARDS ADDITIONAL INFORMATION AND RECOMMENDATIONS

1. Intermediate-Frequency Bandwidth and Transmitter Deviation

The appropriate receiver final intermediate-frequency bandwidth and transmitter deviation depend primarily on the total pulse rate, system noise, and distortion tolerance.

2. Premodulation Filtering

The premodulation filter recommended in Chapter 5 para. 5-6 exhibits a final attenuation slope of 36 db per octave and shall have a maximally linear phase response.

REVISED NOVEMBER 1975

APPENDIX E

PDM STANDARDS
ADDITIONAL INFORMATION AND RECOMMENDATIONS

NOTE

This Appendix has been deleted due to lack of use. Ranges which have an established capability are encouraged to maintain it as long as current needs exist; however, application of other standards is recommended for new programs. It is recommended that the ranges not buy new equipment related to this deleted Appendix.

APPENDIX F

MAGNETIC TAPE RECORDER/REPRODUCER INFORMATION AND USE CRITERIA

1. Configurations not now included in IRIG Standards

Special applications of recorder/reproducer equipment have resulted in many configurations not now included in IRIG Standards. Among those which show promise in improving recording and tape-use efficiency are the high-density track configurations proposed by the Electronic Industries Association P 8.7 Working Group on Instrumentation Magnetic Tape Recording and the double-density wideband recording systems under development by several manufacturers.

a. Double-density recording

Systems have been demonstrated using special heads and modified electronics, and special high-output magnetic tape which will give direct recording to 1.5 MHz at 60 ips (1524 mm/s) without serious degradation of system signal-to-noise ratio. If field experience proves these systems reliable over a reasonable operating time, economies in tape use could result.

b. High-density track configuration

EIA has proposed standardization of tape track configurations resulting in 14 and 21 tracks on ½ inch (12.7 mm) magnetic tape and 28 and 42 tracks on 1-inch (25.4 mm) magnetic tape. Systems for 1-inch (25.4 mm) tape have been manufactured. The EIA proposed track configurations as modified by the International Standards Organization (150/TC97/SC4/WG5) Nov. 1971 are shown in Tables 19 through 22. Also see Figure 5 and Table 13.

c. Several methods for recording serial PCM data at bit-packing densities of 20,000 bits per inch or greater have become available. These methods employ some form of a biphasic code such as the Manchester code. These encoding methods ensure enough flux transitions that DC or very low frequency response is not required. Additionally, bit-rate recovery is enhanced so that reproduce electronics can be phase-locked to the bit stream and provide coherent recovery.

For these systems wideband instrumentation recorders are employed, but special record and reproduce electronics are required.

Standards have not been prepared in this area, but such systems appear attractive for recording large quantities of PCM data.

2. **Gap Scatter** - The distance between two lines perpendicular to the Head Reference Surface which contains components of azimuth misalignment and deviations from the average line defining the azimuth. Since both components affect data simultaneity from record to

TABLE 19

Dimensions – Recorded Tape Format
 14 Tracks on ½-Inch (12.7 mm) Wide Tape
 (Refer to Figure 9)

Track Width (W)		0.025 ± 0.001 in	(0.64 ± 0.03 mm)
Track Spacing (D)		0.035 in	(0.89 mm)
Data Spacing (s)		1.500 ± 0.001 in	(38.10 ± 0.03 mm) Fixed
		1.500 ± 0.002 in	(38.10 ± 0.05 mm) Adjustable
Edge Margin, Minimum (M_M)		0.005 in	(0.13 mm)
Track Location (reference edge to Track # 1 centerline) (G)		0.020 ± 0.0015 in	(0.50 ± 0.04 mm)
Track Spacing Tolerance (ΔH_n)		0.0015 in	(± 0.04 mm)
Track Number	(H_n)	Inches	Millimetres
	1	0.000	0.000
	2	0.035	0.89
	3	0.070	1.78
	4	0.105	2.67
	5	0.140	3.56
	6	0.175	4.45
	7	0.210	5.34
	8	0.245	6.23
	9	0.280	7.12
	10	0.315	8.01
	11	0.350	8.90
	12	0.385	9.79
	13	0.420	10.68
	14	0.455	11.57

TABLE 20

Dimensions – Recorded Tape Format

21 Tracks on ½-Inch (12.7 mm) Wide Tape
(Refer to Figure 9)

Track Width (W)	0.018 ± 0.001 in	(0.46 ± 0.03 mm)
Track Spacing (D)	0.023 in	(0.585 mm)
Data Spacing (S)	1.500 ± 0.001 in	(38.10 ± 0.03 mm) Fixed
	1.500 ± 0.002 in	(38.10 ± 0.05 mm) Adjustable
Edge Margin, Minimum (M _m)	0.007 in	(0.17 mm)
Track Location (reference edge to Track # 1 centerline) (G)	0.07 ± 0.0015 in	(0.44 ± 0.04 mm)
Track Spacing Tolerance (ΔH _n)	± 0.001 in	(± 0.03 mm)

Track Number	(H _n)	Inches	Millimetres
	1	0.000	0.000
	2	0.023	0.585
	3	0.046	1.170
	4	0.069	1.755
	5	0.092	2.340
	6	0.115	2.925
	7	0.138	3.510
	8	0.161	4.095
	9	0.184	4.680
	10	0.207	5.265
	11	0.230	5.850
	12	0.253	6.435
	13	0.276	7.020
	14	0.299	7.605
	15	0.322	8.190
	16	0.346	8.775
	17	0.368	9.360
	18	0.391	9.945
	19	0.414	10.530
	20	0.437	11.115
	21	0.460	11.700

TABLE 21

Dimensions – Recorded Tape Format
28 Tracks on 1-Inch (25.4 mm) Wide Tape
(Refer to Figure 9)

Track Width (W)		0.025 ± 0.001 in	(0.64 ± 0.03) mm)
Track Spacing (D)		0.035 in	(0.89 mm)
Data Spacing (S)		1.500 ± 0.001 in	(38.10 ± 0.03) mm) Fixed
		1.5 ± 0.002 in	(38.10 ± 0.05) mm) Adjustable
Track Location (Reference Edge to Track # 1 centerline) (G)		0.026 ± 0.0015 in	(0.60 ± 0.04) mm)
Edge Margin Minimum M_m)		0.009 in	(0.22 mm)
Track Spacing Tolerance (ΔH_n)		± 0.002 in	(± 0.04 mm)
Track Number	(H_n)	Inches	Millimetres
	1	0.000	0.00
	2	0.035	0.89
	3	0.070	1.78
	4	0.105	2.68
	5	0.140	3.56
	6	0.175	4.45
	7	0.210	5.34
	8	0.245	6.23
	9	0.280	7.12
	10	0.315	8.01
	11	0.350	8.90
	12	0.385	9.79
	13	0.420	10.68
	14	0.455	11.57
	15	0.490	12.46
	16	0.525	13.35
	17	0.560	14.24
	18	0.595	15.13
	19	0.630	16.02
	20	0.665	16.91
	21	0.700	17.80
	22	0.735	18.69
	23	0.770	19.58
	24	0.805	20.47
	25	0.840	21.36
	26	0.875	22.25
	27	0.910	23.14
	28	0.945	24.03

TABLE 22

Dimensions – Recorded Tape Format
42 Tracks on 1-Inch (25.4 mm) Wide Tape
(Refer to Figure 9)

Track Width (W)	0.018 ± 0.001 in	(0.46 ± 0.03 mm)
Track Spacing (D)	0.023 in	(0.585 mm)
Data Spacing (S)	1.500 ± 0.001 in	(38.10 ± 0.03 mm) Fixed
	1.5 ± 0.002 in	(38.10 ± 0.05 mm) Adjustable
Edge Margin, Minimum (M_m)	0.012 in	(0.32 mm)
Track Location (Reference Edge to Track # 1 Centerline)(G)	0.0275 ± 0.0015 in	(0.70 ± 0.04 mm)
Track Spacing Tolerance (ΔH_n)	0.001 in	(0.03 mm)
Track Number (H_n)		

	Inches	Millimetres	Track Number	Inches	Millimetres
1	0.000	0.000	22	0.483	12.285
2	0.023	0.585	23	0.506	12.870
3	0.046	1.170	24	0.529	13.455
4	0.069	1.755	25	0.552	14.040
5	0.092	2.340	26	0.575	14.625
6	0.115	2.925	27	0.598	15.210
7	0.138	3.510	28	0.621	15.795
8	0.161	4.095	29	0.644	16.380
9	0.184	4.680	30	0.667	16.965
10	0.207	5.265	31	0.690	17.550
11	0.230	5.850	32	0.713	18.135
12	0.253	6.435	33	0.736	18.720
13	0.276	7.020	34	0.759	19.305
14	0.299	7.605	35	0.782	19.890
15	0.322	8.190	36	0.805	20.475
16	0.345	8.775	37	0.828	21.060
17	0.368	9.360	38	0.851	21.645
18	0.391	9.945	39	0.874	22.230
19	0.414	10.530	40	0.897	22.815
20	0.437	11.115	41	0.920	23.400
21	0.460	11.700	42	0.943	23.985

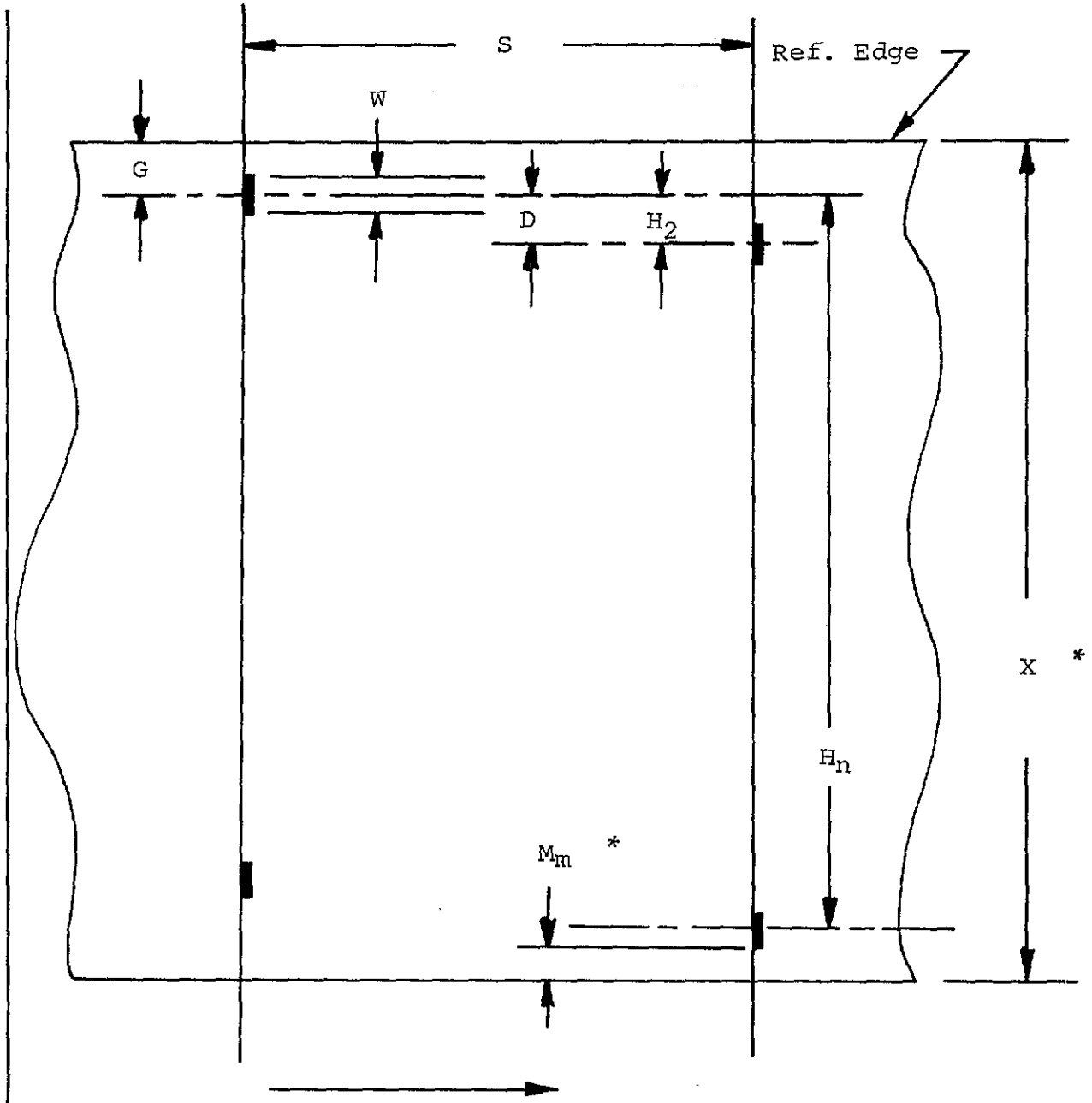

Tape Travel (Magnetic Surface Side)

Values Of X For Different Tape Widths: *

0.498 ± 0.002 in	0.998 ± 0.002 in
(12.65 ± 0.05) mm	(25.35 ± 0.05) mm

* These items deleted by ISO/TC97/SC4/WG-5, Nov 1971.

FIGURE 9. RECORDED TAPE FORMAT

reproduce, the measurement is the inclusive distance containing the combined errors. Since azimuth adjustment affects the output of wideband systems a 0.0002-inch (5.08 μm) gap scatter is allowed for such recorder/reproducers, whereas a 0.0001-inch (2.54 μm) gap scatter is recommended for fixed-head systems (see upper illustration in Figure 6).

3. Head Polarity

The requirement that a positive pulse at a record amplifier input generate a S-N-N-S magnetic sequence and that a S-N-N-S magnetic sequence on tape produces a positive pulse at the reproduce amplifier output still leaves two interdependent parameters unspecified. These are (1) polarity inversion or non-inversion in record and/or playback amplifiers, and (2) record or playback head winding sense. For purposes of head replacement it is necessary that these parameters be determined by the Range so that an unsuspected polarity inversion on-tape or off-tape will not occur after heads are replaced.

4. Record Level

Normal Record Level is established as the level of a sinusoidal signal of 0.1 upper band edge frequency which, when recorded, results in an output signal having one per cent third harmonic distortion. This level will seldom be optimum for data recording. Signals having noise-like spectral distribution, such as FM/FM telemetry signals, contain high crest factors and should be recorded well below the 0 db, normal record level. Other signals may have to be recorded above the normal record level to give optimum performance in the data system.

Crossplay of tapes from older low- and intermediate-band machines on wideband machines will exhibit bias signal output due to the higher resolution of the wideband reproduce heads and the relatively low bias frequencies employed.

5. **Tape Crossplay Considerations (Wideband)** - Figure 10 illustrates the typical departure from optimum frequency response that may result when crossplaying wideband tapes which were recorded with heads employing different record head gap lengths. Line AA is the idealized output versus frequency plot of a machine with record bias and record level set up per IRIG standards, using a 120-microinch (3.05 μm) Record Head gap length and a 40-microinch (1.02 μm) Reproduce Head gap length. Lines BB and CC represent the output response curves of the same tapes recorded on machines with 200-microinch (5.08 μm) and 50-microinch (1.27 μm) Record Head gap lengths, respectively. Each of these recorders was set up individually per IRIG requirements. The tapes were then reproduced on the machine having a 40-microinch (1.02 μm) Reproduce Head gap length without readjusting its reproduce equalization. The output curves have been normalized to zero db at the 1/10th upper band-edge frequency for the purpose of clarity. The normalized curves may be expected to exhibit a plus or minus 2.0 db variance in relative output over the passband. The tape recorded with the shortest gap length heads will provide the greatest relative output at the upper band edge.

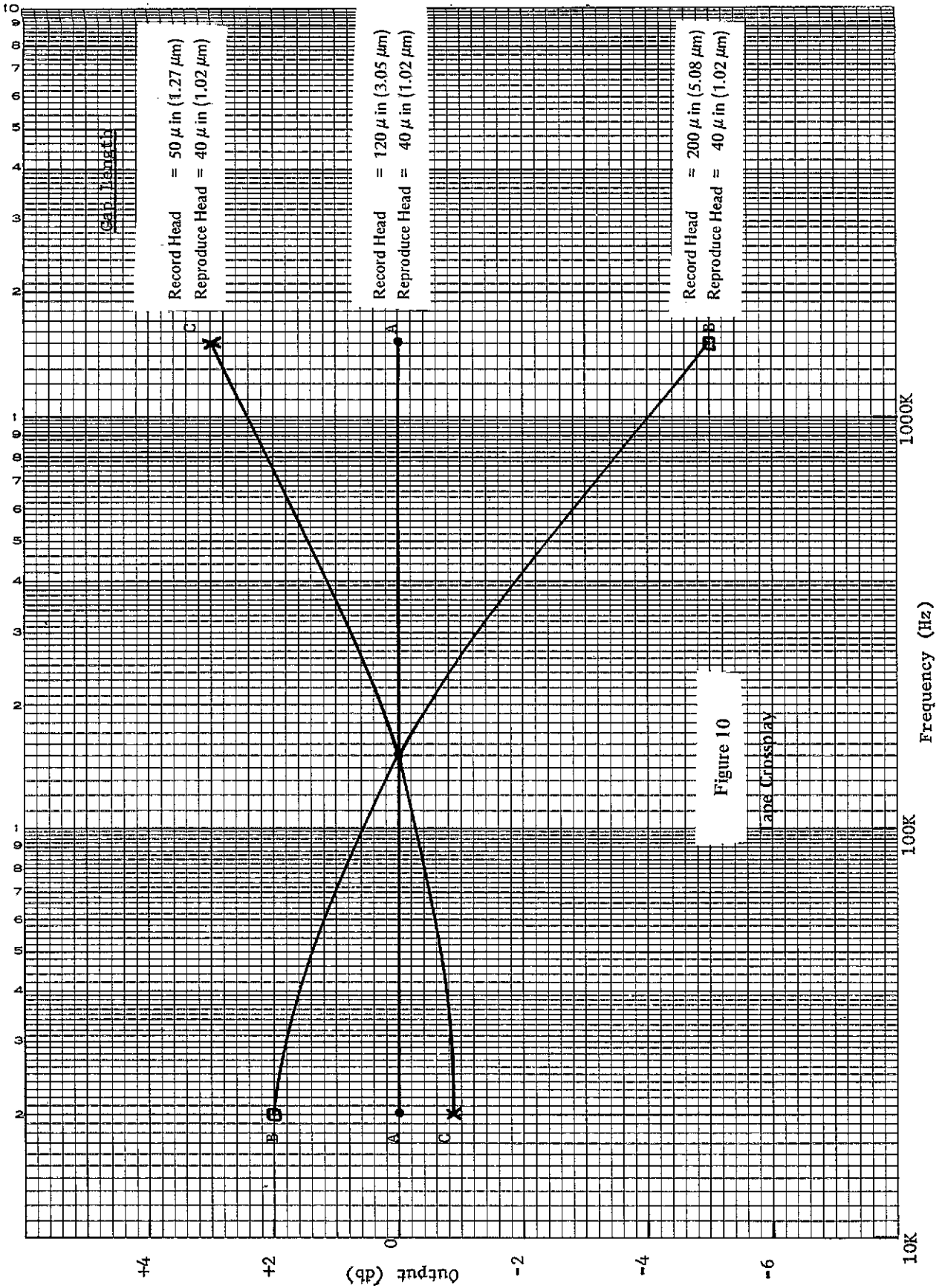

Figure 10
Tape Crossplay

Because of the fact that the IRIG recorder/reproducer setup procedures, as now written, do not establish a uniform recorded flux density on the tape for the different manufacturers' heads, it is recommended that crossplay of tapes between different manufacturers' machines be undertaken with great care.

One method of normalizing the record-playback transfer function is to record a calibration signal sequence on each tape leader so that equalization and gain of the reproduce amplifiers may be properly adjusted during the reproduce process. First, an upper band-edge sinusoidal signal should be recorded on at least one odd-numbered and one even-numbered track for adjustment of reproduce-head azimuth. Then it is recommended that a 1/10 upper band-edge sinusoidal signal set at Normal Record Level followed by a band limited white noise signal set 6 db below normal record level be recorded on each track. Gain is adjusted using the sinusoidal signal and equalization is adjusted with the recorded white noise. It is important that the noise generator signal be low-pass filtered at the upper band edge of the recorder/reproducer response being employed. Most reproduce amplifier inputs are not band-limited, and out-of-band noise contributes to front end saturation or overload effects which will result in excessive intermodulation noise in the desired passband.

APPENDIX G

INDEX

A	F
Allocation: 1435-1535 MHz Bands, 4; A-3 2200-2300 MHz Bands, 5; A-3 Analog Tape Geometry, 7-3a.(2); 29 (Fig 5)	FM Subcarriers, 3-3 Channel Characteristics, 3-4 Range Capability, B-4 FM Subcarrier Tradeoffs, B-2; B-3 Fixed Head Recorder/Reproducer, 7-2 Flexibility, 8-12e. Flutter Compensation Magnetic Tape, 7-3h. Frequency Bands 225 to 260 MHz, 1-8; 2-1 1435 to 1535 MHz, 1-8b.; 2-2; 2-4 2200 to 2300 MHz, 2-5 Frequency Parameters, 1-7 Frequency Tolerance, 2-1a.; 2-7b(1) Frictional Vibration, 8-11e. Fungus Resistance, 8-12g.
B	G
Bias Level, 8-13a. Bi-Directional Performance, 8-11d. Bi-Phase, 18 (Fig 1A)	Gap Scatter, 7-3b(6); F-1
C	H
Channel Bandwidth Definitions, A-2 Channel Spacing Allocations, A-2; A-3 Constant Amplitude Speed Control, 7-3h(2)(a) Criteria of Telemetry Transmitter and Receiver Systems, 1-7	Head and Stack Configurations Magnetic Tape, 7-3a.; 30 (Fig 6) Parallel PCM, 7-7 Head Polarity Magnetic Tape, 7-3c. Humidity Stability, 8-12d.
D	I
Delay Modulation, 18 (Fig 1A) Dimensional Specifications, 8-11a. Direct Recording, 7-3 Durability, 8-13g.	Inflammable Materials, 8-9f. Interference, 2-6c(2) Protection, 2-7b.
E	
Electrical Resistance, 8-12h. Environmental Conditions, 8-11b. Erasure, 8-13j.	

INDEX (Cont'd)

- L
- Layer-to-Layer Adhension, 8-12f.
 Layer-to-Layer Signal Transfer, 8-13i.
- M
- Magnetic Tape
 Characteristics, 7-3a.
 Detailed Requirements, 8-10
 Flutter Compensation, 7-3h.
 General Characteristics, 8-11
 General Requirements, 8-9
 Guiding, 7-3d.
 Head and Head-Stack Configurations, 7-3b.
 Marking and Identification, 8-9
 Physical Characteristics, 8-12
 Production Identification, 8-9b(2)
 Requirements, 8-8
 Speeds, 7-2a.
 Standards, Chapter 8
 Magnetic Tape Recorder/Reproducer
 Bandwidths, 7-2b
 Information and Criteria, Appendix F
 Standards, Chapter 7
 Manufacturer's Centerline Tape, 8-3
 Performance Requirements, 8-5
 Use, 8-6
 Manufacturer's Secondary Centerline
 Tape, 8-4
 Use, 8-6
 Modulation Noise, 8-13h.
- P
- Packaging
 Magnetic Tape, 8-9b.
 Parallel PCM, 7-7
 PCM Recording
 Magnetic Tape, 7-5
 Format, Table 11
 Permanent Elongation, 8-12c.
 Power, 2-2
 Prediction Recording, 7-3j.
 Pulse Amplitude Modulation (PAM)
 Frame and Pulse Structure, 5-2
 Frame and Pulse Rate, 5-3
 Frequency Modulation, 5-5
 Multiple and Submultiple Sampling
 Rates, 5-4
 Premodulation Filtering, 5-6
 Standards, Chapter 5; Appendix D
- Pulse Code Modulation (PCM)
 Bit Rate, 4-3
 Multiple and Submultiple
 Samplings, 4-4
 Radio Frequency and Subcarrier
 Modulation, 4-5
 Spectral Density of:
 NRZ, BIØ, DM; C-2 (Fig 9)
 Standards, Chapter 4; Appendix C
 Theoretical Performance of,
 C-3 (Fig 10)
 Word and Frame Structure, 4-2
- R
- Radial Clearance, 8-9e.
 Recorder Input Characteristics, 7-7j
 Record Level, 8-13b.
 Record Level Bias, F-7
 Recorder Output Characteristics, 7-7k.
 Record/Reproduce Bandwidths, 7-2b.
 Record Parameters, 7-3f.
 Reels and Hubs, 8-9d.
 Reproduce Parameters, 7-3g.
- S
- Scatterwind, 8-11f.
 Shock Tensile Strength, 8-12b.
 Short Wavelength Instantaneous
 Non-Uniformity (Dropout), 8-13f.
 Short Wavelength Output
 Uniformity, 8-13e.
 Single Carrier FM Record Wideband FM
 Record System, 7-4
 Sinusoidal Speed-Control Signals
 Magnetic Tape, 7-3h(2)
 Spurious Emission, 2-1c(1); 2-2a;
 2-6c; 2-7a.
 Storage Life, 8-11c.
 Subcarriers
 FM, 3-3; 3-4
- T
- Tape Abrasivity, 8-12i.
 Tape Crossplay Considerations
 (Wideband), F-7
 Tape Requirement Limits, Table 17
 Tape Speed, 7-2a; 7-3h(1); Table 7;
 Table 8; Table 9; Table 10

REVISED NOVEMBER 1975

INDEX (Cont'd)

Telemetry Frequency Assignment Guidance,
A-3; A-4; A-5
Test Recorder/Reproducer, 8-7
Timing Signal Recording, 7-3i.
Toxic Compounds, 8-9g.
Track Geometry, 7-3a.(2); 7-7a.
Transducers
Characteristics and Performance, 9-3
Terminology and Definitions, 9-2
Transmitter Systems, 2-1; 2-6

W

Wavelength Response, 8-13c.
Wind, 8-9c.

Y

Yield Strength, 8-12a.