

CHAPTER 6

Recorder & Reproducer Command and Control

Acronyms	6-v
Chapter 6. Recorder & Reproducer Command and Control	6-1
6.1 Introduction	6-1
6.1.1 Definitions and Acronyms	6-1
6.1.2 Storage Media Structure Hierarchy	6-1
6.1.3 Data Flows	6-1
6.1.4 Recorder and/or Reproducer States	6-6
6.1.5 Recorder and/or Reproducer Features	6-8
6.1.6 System Health	6-8
6.2 CLI Command and Control	6-11
6.2.1 Command Syntax and Rules	6-14
6.2.2 Command Error Codes	6-14
6.2.3 Mandatory Command Descriptions	6-15
6.2.4 Optional Command Descriptions.....	6-24
6.2.5 Command Validity Matrix.....	6-34
6.2.6 Required Command Subset.....	6-35
6.3 MIL-STD-1553 Remote Terminal Command and Control	6-36
6.4 Discrete Command and Control	6-36
6.4.1 Control and Status Lines.....	6-36
6.4.2 Voltage.....	6-38
6.4.3 Status Updates.....	6-38
6.5 Commands for RMM Devices	6-38
6.5.1 Mandatory Commands.....	6-38
6.5.2 Date and Time Setting Requirements	6-40
6.5.3 Declassification Supporting Commands.....	6-41
6.5.4 SCSI and iSCSI Commands.....	6-49
6.5.5 Mandatory ORB Formats for the Processor Device Using IEEE 1394b	6-49
6.5.6 Additional Mandatory Commands When Using Ethernet.....	6-54
6.5.7 Additional Non-Mandatory Commands When Using Ethernet.....	6-57
Appendix 6.A. MIL-STD-1553 Remote Terminal Command and Control	A-1
A.1. Receive Messages	A-1
A.1.a. Receive Message Length	A-1
A.1.b. Assign Command.....	A-2
A.1.c. BIT Command	A-4
A.1.d. Erase Command.....	A-5
A.1.e. Event Command.....	A-6
A.1.f. Info (receive) Command.....	A-8

A.1.g.	Pause Command.....	A-10
A.1.h.	Queue Command	A-12
A.1.i.	Record Command	A-14
A.1.j.	Replay Command.....	A-15
A.1.k.	Reset Command.....	A-20
A.1.l.	Resume Command.....	A-21
A.1.m.	Sanitize Command.....	A-23
A.1.n.	Stop Command.....	A-25
A.1.o.	Time Command	A-26
A.1.p.	Sync Command.....	A-31
A.2.	Transmit Messages.....	A-33
A.2.a.	Transmit Message Length.....	A-33
A.2.b.	Events Command	A-33
A.2.c.	Health Command	A-35
A.2.d.	Info (transmit) Command	A-37
A.2.e.	Status Command	A-43
A.3.	Command Acceptability and Validity.....	A-52
Appendix 6-B.	Definitions	B-1
Appendix 6-C.	Citations.....	C-1

List of Figures

Figure 6-1.	Recording Data Flow	6-2
Figure 6-2.	Reproducing Data Flow	6-3
Figure 6-3.	Circuit-Looping Live Data Flow	6-3
Figure 6-4.	Media-Looping Recorded Data Flow	6-4
Figure 6-5.	Publishing Live Data Flow	6-4
Figure 6-6.	Publishing Recorded Data Flow	6-5
Figure 6-7.	Downloading Data Flow	6-5
Figure 6-8.	Uploading Data Flow	6-6
Figure 6-9.	Required Discrete Control Functions.....	6-36
Figure 6-10.	Discrete Control and Indicator Functional Diagram.....	6-37
Figure 6-11.	Updating the Bad Block Table.....	6-43
Figure 6-12.	Login ORB Format	6-50
Figure 6-13.	Login Response Format	6-50
Figure 6-14.	Send Command ORB Format	6-51
Figure 6-15.	Send Data Buffer Format	6-51
Figure 6-16.	Receive Command Block ORB Format.....	6-52
Figure 6-17.	Receive Data Buffer Format ASCII Format	6-53
Figure 6-18.	Receive Data Buffer Binary Format	6-54

List of Tables

Table 6-1.	State Bit Assignments.....	6-7
------------	----------------------------	-----

Table 6-2.	Use of Status Bits.....	6-8
Table 6-3.	Command Summary	6-11
Table 6-4.	Command Error Codes	6-15
Table 6-5.	Recorder States	6-19
Table 6-6.	PUBLISH_CFG Keywords.....	6-31
Table 6-7.	Command Validity Matrix.....	6-34
Table 6-8.	Required Commands.....	6-35
Table 6-9.	Recorder/Reproducer Status Lines	6-38
Table 6-10.	Mandatory Commands (All Interfaces)	6-38
Table 6-11.	Additional Mandatory Commands for Declassification	6-39
Table 6-12.	Additional Mandatory Commands for Ethernet Interface	6-39
Table 6-13.	Non-Mandatory Commands for Ethernet Interface	6-40
Table 6-14.	Removable Memory Module .HEALTH Command Response	6-40
Table 6-15.	Removable Memory Module States.....	6-48
Table 6-16.	Command Error Codes	6-49
Table A-1.	Military Standard 1553 Receive (Bus Controller to Remote Terminal) Command Set.....	A-1
Table A-2.	Military Standard 1553 Transmit (Remote Terminal to Bus Controller) Command Set.....	A-33
Table A-3.	Military Standard 1553 Command Acceptability and Validity	A-52

This page intentionally left blank.

Acronyms

ASCII	American Standard Code for Information Interchange
BC	bus controller
BIT	built-in test
C&C	command and control
CLI	command line interface
DHCP	Dynamic Host Control Protocol
FTP	File Transfer Protocol
IAW	in accordance with
IBIT	initiated built-in test
iSCSI	Internet Small Computer System Interface
lsb	least significant bit
mA	milliamps
MIL-STD	Military Standard
MRTFB	Major Range and Test Facility Base
ms	millisecond
msb	most significant bit
MTU	maximum transmission unit
N/A	not applicable
ORB	operation request block
PCM	pulse code modulation
ppm	parts per million
PTP	Precision Time Protocol
R/R	recorder and/or reproducer
RMM	removable memory module
RSCF	recorder setup configuration file
RT	remote terminal
SCSI	Small Computer System Interface
SSD	solid-state disk
TMATS	Telemetry Attributes Transfer Standard
UDP	User Datagram Protocol
V	volts

This page intentionally left blank.

CHAPTER 6

Recorder & Reproducer Command and Control

6.1 Introduction

This chapter defines the standard commands, queries, and status information when communicating with a recorder and/or reproducer (R/R) that uses random access storage (typically either solid-state or magnetic disk). Not all commands (CLI or discrete) may be applicable to all types of R/R implementations. Commands are used to a) control the data flow into and out of, b) request the performance of an internal operation within, and c) request status information from an R/R. The primary intent of this chapter is to cover terminology included in or consistent with the [Chapter 10](#) standard. The CLI and discrete interfaces are divided into two categories of “command sets” as follows:

- a. ***Required***: The minimum set of discrete and CLI commands for R/R control, query, and status.
- b. ***Optional***: The optional discrete or CLI command sets that may or may not be implemented and may be shown as references.

This chapter standardizes command and control (C&C) over a variety of different electrical interfaces. These commands can be transmitted via various electrical interfaces (ports) defined in Section 10.7 of [Chapter 10](#), including Military Standard (MIL-STD)-1553, RS-232, RS-422, Small Computer System Interface (SCSI), Fibre Channel, IEEE 1394 (FireWire), internet SCSI (iSCSI) over networks, and Telnet.

When an R/R simultaneously supports multiple interfaces, it must comply with the interface and command precedence specified in this chapter. While this standard may serve as a guide in the procurement of ground and airborne recorders, it is not intended to be a substitute for a purchase specification. This standard does not necessarily conform to, nor does it define, existing or planned capabilities of any given test range.

6.1.1 Definitions and Acronyms

As of RCC 106-17, this section is moved to [Appendix 6-B](#).

6.1.2 Storage Media Structure Hierarchy

Support for multiple data flows to and from multiple storage devices requires hierarchical structures for C&C. The following terms defined in [Appendix 6-B](#) have the following hierarchy from lowest layer to highest layer.

- a. Drive
- b. Volume
- c. File

6.1.3 Data Flows

An R/R has five categories of data interfaces, listed below.

- a. Data input
- b. Data output
- c. R/R to/from Media
- d. Network port(s)
- e. Download port(s)

The figures below identify eight different data flows between these interfaces that are initiated or terminated by commands defined in this chapter. An R/R may simultaneously support more than one of these data flows.

6.1.3.1 Recording

The recording data flow receives live data from input data channels and writes the data in Chapter 10 format to the media. This mode can be activated by the .RECORD command. [Figure 6-1](#) depicts the recording data flow.

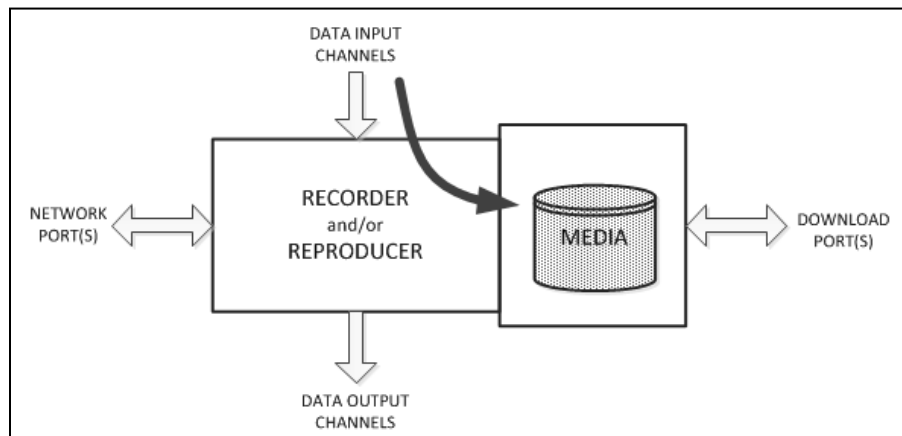

Figure 6-1. Recording Data Flow

6.1.3.2 Reproducing

The reproducing data flow reads Chapter 10 data stored in a file on the media and sends it out on data output channels. [Figure 6-2](#) depicts the reproducing data flow. The output data format may or may not be the same as the original input format, depending on the capabilities of that unique reproducer. For example, video originally input as S-Video (separate Chroma and Luma) may be output as composite. Messages in MIL-STD-1553 format captured from a dual-redundant bus monitor may be reproduced as a Chapter 8 pulse code modulation (PCM) signal. This mode can be activated by the .PLAY command.

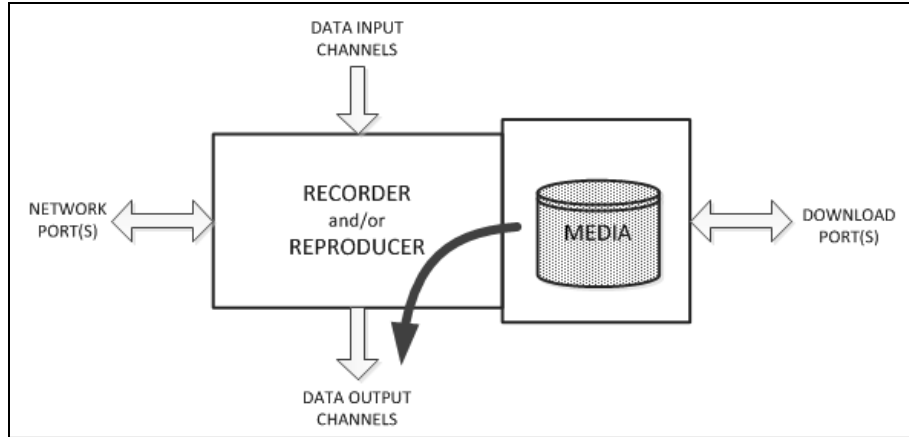

Figure 6-2. Reproducing Data Flow

6.1.3.3 Simultaneous Recording and Reproducing

The recording and reproducing data flows can be combined to simultaneously write to and read from the media. The recording and reproducing data rates are independent, and the output may reproduce more or fewer channels than are currently being input. Starting and stopping the recording and reproducing are also independent and may be started and stopped in any order. The combined flows are also referred to as “read-while-write.”

6.1.3.4 Looping

The looping data flow combines data input with data output using a common time base on both the input and output. The looping data flow can be divided into live data looping and recorded data looping. Looping may output all or a subset of the input channels.

6.1.3.4.1 Looping Live Data

Circuit-looping live data does not utilize the drive. Data is moved from the input channels directly to the output channels. The output data rates are derived from the data rate of the corresponding data input. This mode can be activated by the .ETOELOOP command. [Figure 6-3](#) depicts the circuit-looping live data flow.

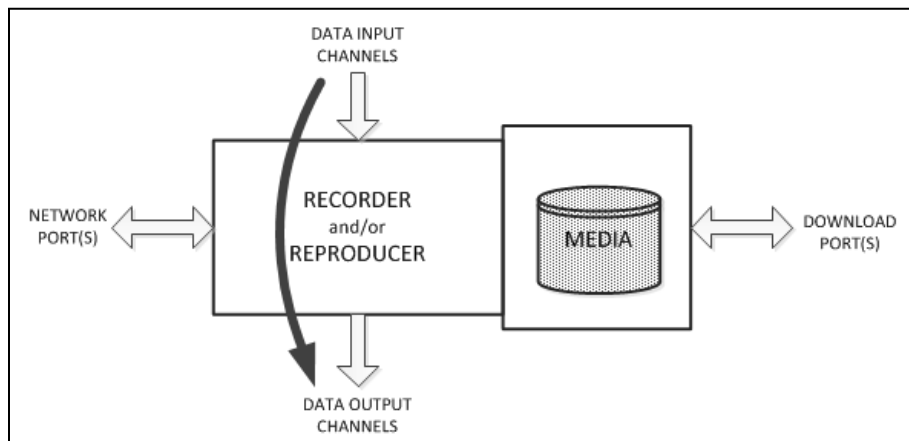

Figure 6-3. Circuit-Looping Live Data Flow

6.1.3.4.2 Looping Recorded Data

Media-looping (or drive-looping) recorded data does involve the media and is commonly referred to as “read-after-write.” The output data rates are derived from the data rate of the corresponding data input. The dotted line in [Figure 6-4](#) depicts the common time base of the recorded and reproduced data when media-looping recorded data. This mode can be activated by the .LOOP command.

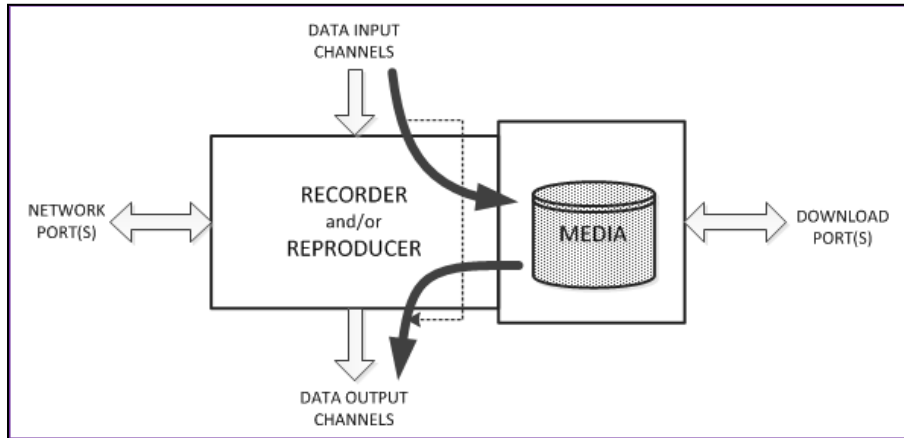

Figure 6-4. Media-Looping Recorded Data Flow

6.1.3.5 Publishing

The publishing data flow is used to transmit live or recorded data in Chapter 10 packet format on a network interface (e.g., Ethernet); note that the network interface used for publishing will typically be distinct from the network interface(s) used for acquisition or reproduction.

6.1.3.5.1 Publishing Live Data

Live data publishing provides minimum latency between input of live data in raw data format and output of packetized Chapter 10 data over a network interface. The data output rate is determined by the live data input rate. [Figure 6-5](#) depicts the broadcasting live data flow. The mode can be activated by the .PUBLISH command.

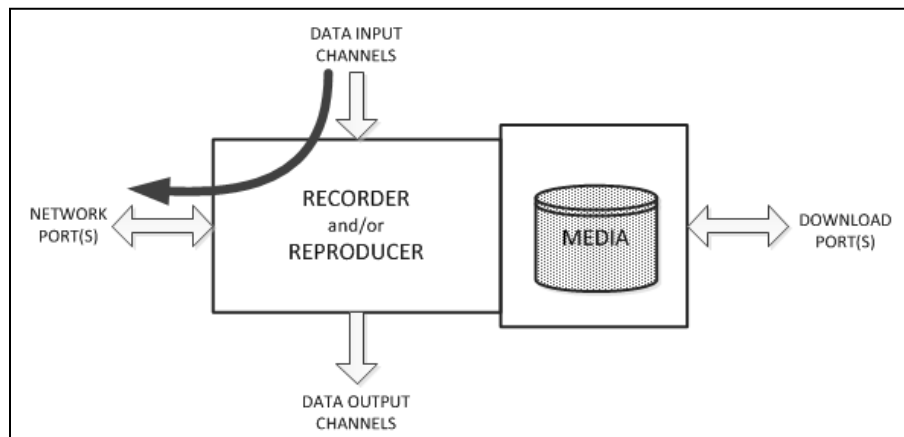

Figure 6-5. Publishing Live Data Flow

6.1.3.5.2 Publishing Recorded Data

Recorded data publishing enables any previously recorded data to be transmitted via a network interface in Chapter 10 packet format. The transmitted data rate is limited by the lesser of the drive access rate and the available network bandwidth and may optionally be constrained to the rate at which the data was recorded. [Figure 6-6](#) depicts the publishing recorded data flow. The mode can be activated by the .PUBLISH FILE command.

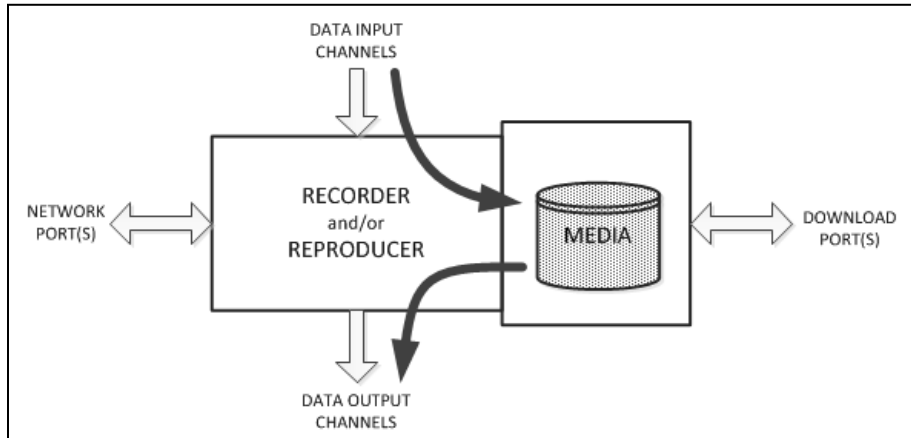

Figure 6-6. Publishing Recorded Data Flow

6.1.3.6 Downloading

The downloading data flow transfers Chapter 10 format data from the drive to the host. For drives formatted as Chapter 10 volumes, the SCSI protocol may be used by the host to access file directories and data files. Downloading files from non-Chapter 10 volumes is outside the scope of this standard. [Figure 6-7](#) depicts the downloading data flow.

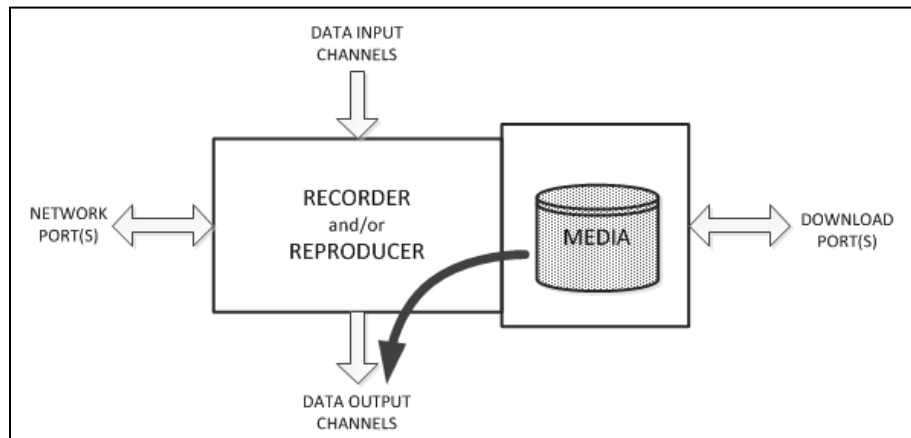

Figure 6-7. Downloading Data Flow

6.1.3.7 Uploading

The uploading data flow transfers Chapter 10 format data from the host to the drive. For drive formatted as Chapter 10 volumes, the SCSI protocol may be used by the host to update file directories and data files. Uploading files to non-Chapter 10 volumes is outside the scope of this standard. [Figure 6-8](#) depicts the uploading data flow.

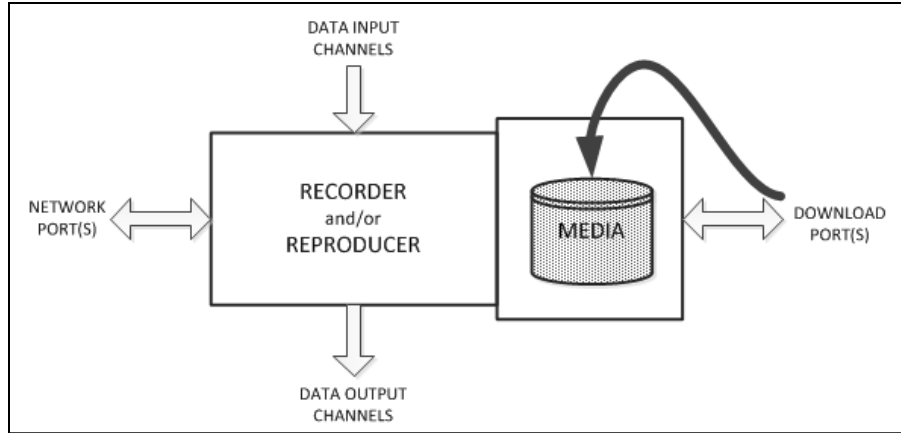

Figure 6-8. Uploading Data Flow

6.1.4 Recorder and/or Reproducer States

Previous versions of the R/R C&C identified eleven states of R/R operation, ten of which are discrete states and one (07) is a combination of two states (05 + 06).

- FAIL (00)
- IDLE (01)
- BIT (02)
- ERASE (03)
- DECLASSIFY (04)
- RECORD (05)
- PLAY (06)
- RECORD & PLAY (07)
- FIND (08)
- BUSY (09)
- COMMAND ERROR (10)

The addition of multiple ports and drives to an R/R requires the definition of new discrete states and new composite states. The state numbers have been redefined so their value is the binary representation of each of the possible discrete states, with composite states represented by simultaneous assertion of multiple discrete state bits. The use of legacy state values is distinguished from the use of these redefined state values by their ranges: legacy states having the values 0 - 10 and new states beginning with 16. [Table 6-1](#) shows the redefined state bits.

Table 6-1. State Bit Assignments

3	3	2	2	2	2	2	2	2	2	2	1	1	1	1	1	1	1	1	1	9	8	7	6	5	4	3	2	1	0	State Bit / Name				
1	0	9	8	7	6	5	4	3	2	1	0	9	8	7	6	5	4	3	2	1	0													
0	0	0	0	0	0	0	0	0	0	0	0	0	0	0	0	0	0	0	0	0	0	0	0	0	0	1	-	-	-	-	IDLE			
0	0	0	0	0	0	0	0	0	0	0	0	0	0	0	0	0	0	0	0	0	0	0	0	0	0	1	0	-	-	-	-	FAULT		
0	0	0	0	0	0	0	0	0	0	0	0	0	0	0	0	0	0	0	0	0	0	0	0	0	1	0	0	-	-	-	-	BIT		
0	0	0	0	0	0	0	0	0	0	0	0	0	0	0	0	0	0	0	0	0	0	0	0	0	1	0	0	0	-	-	-	-	ERASE	
0	0	0	0	0	0	0	0	0	0	0	0	0	0	0	0	0	0	0	0	0	0	0	0	0	1	0	0	0	0	-	-	-	-	CLEAN
0	0	0	0	0	0	0	0	0	0	0	0	0	0	0	0	0	0	0	0	0	0	0	0	0	1	0	0	0	0	-	-	-	-	SANITIZE
0	0	0	0	0	0	0	0	0	0	0	0	0	0	0	0	0	0	0	0	0	0	0	0	1	0	0	0	0	0	-	-	-	-	SANITIZE PASS
0	0	0	0	0	0	0	0	0	0	0	0	0	0	0	0	0	0	0	0	0	0	0	0	1	0	0	0	0	0	-	-	-	-	SANITIZE FAIL
0	0	0	0	0	0	0	0	0	0	0	0	0	0	0	0	0	r	r	r	r	0	0	0	0	0	0	0	0	-	-	-	-	reserved	
x	x	x	x	x	x	x	x	x	x	x	x	x	x	x	1	0	0	0	0	0	0	0	0	0	0	0	0	0	-	-	-	-	RECORD	
x	x	x	x	x	x	x	x	x	x	x	x	x	x	1	x	0	0	0	0	0	0	0	0	0	0	0	0	0	-	-	-	-	REPRODUCE	
x	x	x	x	x	x	x	x	x	x	x	x	1	x	x	0	0	0	0	0	0	0	0	0	0	0	0	0	0	-	-	-	-	FIND	
x	x	x	x	x	x	x	x	x	x	x	1	x	x	x	0	0	0	0	0	0	0	0	0	0	0	0	0	0	-	-	-	-	LOOP	
x	x	x	x	x	x	x	x	x	x	1	x	x	x	x	0	0	0	0	0	0	0	0	0	0	0	0	0	0	-	-	-	-	BROADCAST	
x	x	x	x	x	x	x	x	x	1	x	x	x	x	x	0	0	0	0	0	0	0	0	0	0	0	0	0	0	-	-	-	-	BUSY	
x	x	x	x	x	x	x	x	1	x	x	x	x	x	x	0	0	0	0	0	0	0	0	0	0	0	0	0	0	-	-	-	-	COMMAND FAIL	
r	r	r	r	r	r	r	r	r	r	x	x	x	x	x	x	0	0	0	0	0	0	0	0	0	0	0	0	0	-	-	-	-	reserved	
- = reserved for legacy codes																																		
r = reserved																																		
x = don't care																																		

The R/R states are defined as follows (alphabetical order, at least one of these bits must always be set):

- BIT - A built-in test (BIT) is in progress
- BROADCAST - Transmit live or recorded data out of an Ethernet interface via User Datagram Protocol (UDP) packets
- BUSY - Transition between states
- CLEAN - The drive is being overwritten with all 0s or all 1s
- ERASE - The file table on the drive is being reset to empty
- FAULT - The BIT failed and further diagnostics are required
- FIND - Locate a position within the recorded data on the drive for subsequent replay
- IDLE - The R/R is powered on, ready to accept commands, and no data flows are active
- LOOP - Reproduce live data synchronously with data input with or without recording
- RECORD - Input data, encapsulate into Chapter 10 packets, and store on the drive
- REPRODUCE - Read Chapter 10 data from the drive and output in raw form
- SANITIZE- Perform a secure erase of the attached drive

R/R Command Results:

- COMMAND FAIL - A previous operation, such as BIT or FIND, failed
- SANITIZE FAIL - The sanitize procedure failed

SANITIZE PASS - The sanitize procedure succeeded

6.1.5 Recorder and/or Reproducer Features

Each R/R can be described as a single controller with one or more channels, one or more ports, and some media (typically but not necessarily consisting of one or more discrete drives). A single controller unit may contain multiple processors and/or cores, but it may only have one command sequence. When a controller is capable of receiving commands simultaneously from different sources into its single command sequence, the precedence of the command sources and the resultant operational sequence shall be as defined in this C&C standard. For example, an R/R may have a discrete switch control panel located at the R/R site, a serial port, and may also be connected to a network interface for remote C&C operation.

Both channels and ports may transport data and/or control information. The differentiating factor is that data transferred across ports is already formatted by or for the R/R R/R (e.g., into the packet format mandated by [Chapter 10](#)), whereas data transferred across channels is not. Each data/control channel is identified by a channel ID. Each data/control port is identified by a port ID. The combination of channels, ports, and media managed by the single processor unit of an R/R, and the controller unit itself, are all features of the R/R. Note that some R/R designs will have additional features, such as multiple distinct media types or pools, or built-in processing capabilities (e.g., for real-time display of data); these features are neither precluded nor defined by this standard.

6.1.6 System Health

The system health of an R/R can be stratified into two attribute levels: common (high-level) and device-specific (low-level, typically vendor unique). Common attributes, such as power-on self-test results, are independent of the specific tests performed by unique vendor system architectures. This C&C system provides a method for reporting required health attributes common to all systems and discretionary vendor-specific health attributes.

This C&C system further divides system health status information into two categories: critical and non-critical. Critical faults are typically those that render the R/R inoperable, whereas non-critical faults are informational warnings. This C&C system enables the user to establish the criticality of each reported system health attribute.

The health of each feature is represented by a 32-bit binary word in which each bit represents a single attribute of the feature. The attributes represented by bits 0 through 7 of each feature are common to all R/Rs containing those features and are defined in this standard. The attributes represented by bits 8 through 31 are unique to each R/R and are defined separately in vendor-specific documents.

Any health attribute bit that is set (“1”) indicates a warning or fault. The .HEALTH command is used to retrieve the current state of the health attribute bits for each feature of the R/R. [Table 6-2](#) shows the common attribute bits for currently defined Chapter 10 data types and R/R features.

Table 6-2. Use of Status Bits			
Feature	Bit	Mask (Hex)	Description
System	0	01	BIT Failure

Table 6-2. Use of Status Bits			
Feature	Bit	Mask (Hex)	Description
	1	02	Setup Failure
	2	04	Operation Failure
	3	08	Drive Busy Unable to Accept Command
	4	10	No Drive
	5	20	Drive I/O Failure
	6	40	Drive Almost Full
	7	80	Drive Full
	31-8		Vendor-Specific Health Status Bits
Time Code	0	01	BIT Failure
	1	02	Setup Failure
	2	04	No External Signal
	3	08	Bad External Signal
	4	10	Synchronize Failure
	5	20	Reserved for future Chapter 10 status bit
	6	40	Reserved for future Chapter 10 status bit
	7	80	Reserved for future Chapter 10 status bit
31-8		Vendor-Specific Health Status Bits	
PCM	0	01	BIT Failure
	1	02	Setup Failure
	2	04	Bad Clock Failure
	3	08	Bad Data Failure
	4	10	Minor Frame Sync Failure
	5	20	Major Frame Sync Failure
	6	40	Bit Sync Lock Failure
	7	80	Watch Word Failure
31-8		Vendor-Specific Health Status Bits	
1553	0	01	BIT Failure
	1	02	Setup Failure
	2	04	Response Timeout Error
	3	08	Format Error
	4	10	Sync Type or Invalid Word Error
	5	20	Word Count Error
	6	40	Reserved for future Chapter 10 status bit
	7	80	Watch Word Failure
31-8		Vendor-Specific Health Status Bits	
Video	0	01	BIT Failure
	1	02	Setup Failure
	2	04	No Video Signal Error
	3	08	Bad Video Signal Error
	4	10	No Audio Signal Error
	5	20	Bad Audio Signal Error

Table 6-2. Use of Status Bits			
Feature	Bit	Mask (Hex)	Description
	6	40	Reserved for future Chapter 10 status bit
	7	80	Reserved for future Chapter 10 status bit
	31-8		Vendor-Specific Health Status Bits
Analog	0	01	BIT Failure
	1	02	Setup Failure
	2	04	No Analog Signal Error
	3	08	Bad Analog Signal Error
	4	10	Reserved for future Chapter 10 status bit
	5	20	Reserved for future Chapter 10 status bit
	6	40	Reserved for future Chapter 10 status bit
	7	80	Reserved for future Chapter 10 status bit
31-8		Vendor-Specific Health Status Bits	
Image or Message	0	01	BIT Failure
	1	02	Setup Failure
	2	04	Bad Signal Error
	3	08	Data Content Error
	4	10	Reserved for future Chapter 10 status bit
	5	20	Reserved for future Chapter 10 status bit
	6	40	Reserved for future Chapter 10 status bit
	7	80	Reserved for future Chapter 10 status bit
	31-8		Vendor-Specific Health Status Bits
Other Types	0	01	BIT Failure
	1	02	Setup Failure
	2	04	Bad Signal Error
	3	08	Data Content Error
	4	10	Reserved for future Chapter 10 status bit
	5	20	Reserved for future Chapter 10 status bit
	6	40	Reserved for future Chapter 10 status bit
	7	80	Reserved for future Chapter 10 status bit
	31-8		Vendor-Specific Health Status Bits
Drive	0	01	BIT Failure
	1	02	Setup Failure (Mount)
	2	04	Operation Failure (Processor Command)
	3	08	Drive Busy Unable to Accept Command
	4	10	No Drive
	5	20	Drive I/O Failure
	6	40	Drive Almost Full
	7	80	Drive Full
	31-8		Vendor-Specific Health Status Bits

For single-drive configurations, a single-drive health status can be reported by bits in the System feature. For configurations with multiple drives, each drive is a separate feature specified by the drive ID in the .HEALTH command.

When the Drive feature is used the feature numbers shall not be changed (re-assigned) when the drives are removed / re-plugged from / to the R/R. The drive ID number shall start at 0 and use the same drive numbering as defined in the setup record.

6.2 CLI Command and Control

This standard defines a set of commands used to control and monitor the operation of R/Rs. The availability of each command depends on the feature set of the controlled R/R and the specific control port used to send commands to and receive replies from the R/R. [Table 6-3](#) lists the commands in alphabetical order grouped as the mandatory commands followed by optional ones. The protocols used to send these commands to an R/R and receive replies from an R/R are described separately in [Chapter 10](#) Section 10.3, Section 10.4, and Section 10.7 for each of the defined control port types. Each R/R must support at least one of the control port types described in this standard, and may support multiple control port types.

Table 6-3. Command Summary			
Command	Parameters*	Description	M/O
.CRITICAL	[<i>n</i> [<i>mask</i>]]	Specify and view masks that determine which of the .HEALTH status bits are critical warnings	M
.FILES	[drive ID]	Displays information about each recorded file	M
.HEALTH	[<i>feature</i> [drive ID]]	Display detailed status of the recorder system	M
.HELP		Displays table of dot commands supported by the R/R	M
.IRIG106		Returns supported version number of IRIG-106 Recorder Command and Control Mnemonics	M
.IRIG-106		Synonym for .IRIG106	M
.RECORD	[<i>filename</i>] [stream-ID] [drive ID]	Starts a recording at the current end of data of [stream ID] to [drive ID]	M
.SETUP	[<i>n</i>]	Displays or selects 1 of 16 (0...15) pre-programmed data recording formats	M
.STATUS		Displays the current system status	M
.STOP	[<i>mode</i>] [stream-ID] [drive ID]	Stops the current recording, playback, or both	M
.TIME	[<i>start-time</i>]	Displays or sets the internal system time	M
.TMATS	{ <i>mode</i> } [<i>n</i> ALL]	Write, Read, Save, Delete, Version, Checksum, or Get TMATS file	M
.ASSIGN	[destination-channel ID] [source-channel ID]	Assign replay (output) channels to source (input) channels	O

Table 6-3. Command Summary			
Command	Parameters*	Description	M/O
.BBLIST	{type} [drive ID]	Returns list of secured or unsecured bad blocks	O
.BBREAD	{block identifier} [drive ID]	Returns contents of specified block	O
.BBSECURE	{block identifier} [drive ID]	Marks an unsecured bad block as secure	O
.BIT		Runs all of the built-in-tests	O
.CONFIG		Retrieves Channel Configuration Summary	O
.COPY	[source drive ID] [destination drive ID]	Copies content of source drive to destination drive	O
.DATE	[start-date]	Specify setting or displaying date from recording device	O
.DISMOUNT	[drive ID]	Unloads the recording drive	O
.DRIVE		Lists drives and volumes	O
.DUB	[source drive ID] [destination drive ID]	Image copy. This command is obsolete, but for backward compatibility shall function the same as the .PLAY command.	O
.ERASE	[drive ID] [volume name list]	Erases and format the recording drive	O
.EVENT	[event ID]	Insert an event entry or display captured events list	O
.ETOLOOP	[in stream ID] [out stream ID]	Looping live data mode	O
.FIND	[value [mode]]	Deprecated (search no longer required)	O
.LOOP	[in stream ID][out stream ID]	Starts record and play in read-after-write mode	O
.MEDIA	[drive ID]	Displays drive usage summary	O
.MOUNT	[drive ID]	Powers and enables the recording drive	O
.PAUSE	[stream-ID]	Pause current replay	O
.PLAY	[location][speed] [drive ID]	Reproduce recorded data of assigned output channels starting at [location], at [speed] from [drive ID]	O
.PUBLISH	[keyword] [parameter]	Configure, start and stop live data over Ethernet	O
.PUBLISH_FILE	[parameter] [ip:port] [file] [stream ID]	Configure, start and stop live data over Ethernet interface from a recorded Chapter 10 file	O
.PUBLISH_TCP	TBD	TBD	O
.PUBLISH_CFG	{keyword}	Configures filters on .PUBLISH streams	O

Table 6-3. Command Summary			
Command	Parameters*	Description	M/O
.OUT_CRATE	[rate [FULL HASH]]	Controls the rate at which the configuration/ setup record (TMATS) or checksum of same should be output to the recording stream	O
.QUEUE	[keyword] [parameter]	Specify where to begin replay by event or file number	O
.RCC-106		Synonym for .IRIG106	O
.REPLAY	[location [mode]]	Same as PLAY	O
.RESET		Perform software initiated system reset	O
.RESUME	[stream-ID]	Resume replay from pause condition	O
.SANITIZE	[drive-ID]	Secure erases the recording drive	O
.STREAM	[#] [stream-ID] [Channel-ID List]	Display specified or all stream channel assignments	O
.TCPPOINTS	[n n,n,n]	Displays or sets network characteristics	O
.VERBOSE	[mode]	Enables Verbose ON or disables Verbose	O
.VOLUME		Lists volumes on current drive	O
Parameters in braces “{}” are required. Parameters in brackets “[]” are optional. When optional parameters are nested (“[xxx [yy]]”), the outer parameter (xxx) must be specified in order to also specify the inner parameter (yy). Parameters separated by a vertical bar “ ” are mutually exclusive alternates.			
The letters in parentheses in front of the command names in the section titles below represent mandatory (M) or optional (O) commands.			

This section describes the protocol for implementing Chapter 6 C&C across a command line interface (CLI), such as an asynchronous serial communication port. Not all commands may be applicable to all types of R/R implementations. An important aspect of the CLI C&C protocol is the required command-response sequence. For each command issued to a recorder, there shall be exactly one response from the R/R, and the response shall begin promptly upon conclusion of the command input. There shall be no delay between the receipt of the command at the recorder and the transmission of the reply by the R/R. The reply must not contain any additional line feeds or carriage returns. Commands that initiate operations or functions that require non-negligible time to complete shall respond immediately, and the status of the R/R may be polled to determine when the operation or function is complete. The rate at which commands may be issued (i.e., the minimum interval between the reply to one command and the next command) is defined by specification, not this standard, as is the response of the recorder if the rate is exceeded. There shall be no unsolicited status output from the R/R, with the single exception of a boot message upon leaving the POWER ON state, indicating that the R/R is ready to accept commands. The boot message shall contain a single American Standard Code for Information Interchange (ASCII) asterisk (“*”) as the last character. Thereafter, the R/R shall only produce output in response to a command input. (A hardware reset or a software reset shall return the recorder to the POWER ON state.)

6.2.1 Command Syntax and Rules

All CLI commands must comply with the following syntax and rules.

- a. All R/R commands are simple ASCII character strings delimited by spaces.
- b. All commands begin with an ASCII period (“.”) and, with the single exception of the .TMATS command, end with the first occurrence of a carriage return and line feed terminator sequence.
- c. Parameters are separated from the commands and from each other with ASCII space characters.
- d. With one exception, command words and parameters may not include spaces. The one exception is the [text string] parameter for the .EVENT command.
- e. Multiple consecutive terminators and extraneous space characters shall not be allowed and shall be ignored.
- f. Each command is followed with either a text response plus a carriage return and line feed and an asterisk response terminator or the asterisk response terminator only, indicating the recorder is ready for the next command.
- g. A response shall be provided by the R/R within one second of the command completion sequence (i.e., line feed).
- h. All numeric parameters, with one exception, are decimal numbers. The one exception is the [mask] parameter for the .CRITICAL command, which is hexadecimal.
- i. Two commands, .FIND, and .REPLAY have numeric parameters requiring units of measure. The [mode] parameter is used to specify the unit of measure (time or blocks). If the [mode] parameter is omitted, the recorder shall use the most recently entered [mode].
- j. A [time] parameter value has five parts: days, hours, minutes, seconds, and milliseconds. Any part not entered defaults to zero except days, which defaults to don't care (current day). An ASCII period (“.”) identifies the start of the millisecond part, a hyphen (“-”) separates the day from the hours, and colon characters (“:”) separate the hours, minutes, and seconds. The following are valid times: 123- (day only), 17 (hours only), 17:30 (hours and minutes), 17:30:05 (hours, minutes, seconds), 17:0:05 (hours, minutes, seconds), 17:30:05.232 (hours, minutes, seconds, milliseconds), 123-17 (day, hours), 123-17:30 (day, hours, minutes), etc.
- k. All commands begin with an ASCII period and, with the single exception of the .TMATS command, end with a carriage return and line-feed terminator sequence.
- l. Commands are case insensitive (i.e., they may be upper or lower case).

6.2.2 Command Error Codes

Issuing invalid commands (bad syntax) or illegal commands (not accepted in the current system state) results in error code responses (with an ASCII “E” identifier) prior to the asterisk response terminator when a command cannot be completed. [Table 6-4](#) shows possible error codes and the conditions under which they occur.

<p>Example </p>	<pre>.RECORD E 03 *</pre>
	<p>Means: No drive is installed, recording cannot be executed</p>

Table 6-4. Command Error Codes		
Error	Description	Conditions
00	INVALID COMMAND	Command does not exist
01	INVALID PARAMETER	Parameter is out of range, or wrong alpha-numeric type
02	INVALID MODE	Command cannot be executed in the current state
03	NO DRIVE	Drive is dismounted or not installed
04	DRIVE FULL	Command cannot be executed because there is no free space available on the drive
05	COMMAND FAILED	Command failed to execute for any reason other than those listed above
06	BUSY	Command cannot be executed

6.2.3 Mandatory Command Descriptions

Commands are listed alphabetically.

6.2.3.1 (M) `.CRITICAL [n[mask]]`

The `.CRITICAL` command is used to view and specify the critical warning masks used with the `.HEALTH` command. An encoded 32-bit status word is displayed with the `.HEALTH` command for each feature as defined in the `.HEALTH` command in the R/R. The `.CRITICAL` command allows the user to specify which status word bits constitute critical warnings. If a bit in the `.CRITICAL` mask word for a feature is set, then the corresponding `.HEALTH` status word bit for that feature signals a critical warning.

The `.CRITICAL` command without any parameters returns the mask word for each feature in ascending feature order. The `.CRITICAL` command with a single parameter - the feature number - returns the list of descriptive warning strings and status word bit associations for the specified feature. The `.CRITICAL` command with both the feature number parameter and the 8-character ASCII hexadecimal mask value parameter specifies a new mask value for the feature. All mask values in the command responses are hexadecimal.

<p>NOTE </p>	<ol style="list-style-type: none"> 1. The critical warning is turning the FAULT contact output indicator ON for a Chapter 10-compatible R/R. 2. Critical warnings of individual channels should not inhibit recording.
--	--

<p>Example </p>	<pre>.CRITICAL 0 FFFFFFFF SYSTEM 1 FFFFFFFF TIMEIN 2 000000FF ANAIN-1</pre>
---	--

```
3 0000006F PCMIN-1
4 0000000F PCMIN-2
:
:
15 00000010 1553IN-8
```

Note: The command with no parameters returns the mask for each feature in this and subsequent examples.

Example



.CRITICAL 4

```
4 00000004 PCMIN-2 Bad Clock Failure
4 00000008 PCMIN-2 Bad Data Failure
4 00000010 PCMIN-2 Minor Frame Sync Failure
4 00000020 PCMIN-2 Major Frame Sync Failure
*
```

Note: The command with the feature number parameter only, no mask value, returns all of the possible warning text strings for the specified feature and shows which .HEALTH status word bit is associated with the particular warning.

Example



.CRITICAL 4 0000003C

```
4 0000003C PCMIN-2
```

Note: Entering both the feature number parameter and the mask value parameter resets the mask for the specified feature.

Note: Entering a mask of 0 for the feature number will cause the .HEALTH command to denote a valid state

6.2.3.2 (M) .FILES [drive-ID]

The .FILES command displays a list of character strings showing information about each recording session (file). Each string in the list contains the file number, file name, starting block number, file size in bytes, start day, and start time of the file. For those systems that also store the end day and time of each file, that data may be added to the end of each file string. File names may not contain space or asterisk characters. If user names are not assigned to individual recordings, the default file names shall be “file1,” “file2,” etc. Each file string shall be formatted as shown in the following example (with optional end day and end time).

Example



.FILES

```
1 TPD-10 10000 272760832 001-00:13:58.109 001-
00:14:03.826
2 TPD-11 92884 425984000 001-00:14:11.106 001-
00:14:28.602
3 file3 350790 305430528 123-17:44:06.677 123-
17:44:13.415
```

6.2.3.3 (M) .HEALTH [*feature*[drive-ID]]

The .HEALTH command provides a standard mechanism for status information to be conveyed to the user. The feature parameter is defined as 0 for R/R status, and for each data source it is the decimal reference of the channel ID specified by the “TK1” parameter for the corresponding data source by the Telemetry Attributes Transfer Standard (TMATS) setup record. Entering the command without the optional parameter displays a list of encoded status word for each feature. Entering a decimal feature number parameter with the command decodes the status word for a single feature and displays a list of messages pertaining to the feature, one for each set bit in the status word. (See [Table 6-2](#) for recommended usage of the status bits.) This standard requires that the syntax of the responses to the .HEALTH command conform to the following rules.

- a. If no data sources are implemented, the response to a .HEALTH command is the R/R status only.
- b. In addition to the feature number the command should return a description of the corresponding channel type, composed from the channel type of the source as defined in [Chapter 9](#) parameter “CDT” - a “-” character and the sequence number of that type of channel (e.g., “PCMIN-3” for the 3rd PCM input channel).
- c. The description of a feature may not contain an asterisk character.
- d. The feature list response (no feature number parameter supplied with the command) is a sequence of text strings, each containing the decimal feature number, the 8-character ASCII hexadecimal representation of the 32-bit status word for the feature, a text feature description, and a carriage return and line feed terminator. The value of the 32-bit status word for a healthy feature shall be all zeros. If a feature is disabled, the 8-character ASCII hexadecimal string shall be replaced with eight ASCII hyphen “-” characters.
- e. The individual feature response (feature number parameter supplied with the command) is a sequence of descriptive text strings, one for each set bit in the feature status word. Each string is terminated with a carriage return and line feed.
- f. The critical bits should be cleared when they are reported by a .HEALTH command.

The .CRITICAL command is used to specify and view the mask word for each feature that determines if a set .HEALTH status word bit adds to the total non-critical or critical warning counts displayed with the .STATUS command.

		.HEALTH	
Example 	0	00000000	SYSTEM
	1	00000000	TIMEIN
	2	00000000	ANAIN-1
	3	-----	PCMIN-1
	4	00000034	PCMIN-2
		:	
	15	00000000	1553IN-8
		*	

Example

```

* .HEALTH 4
4 00000004 PCMIN-2 Bad Clock Failure
4 00000010 PCMIN-2 Minor Frame Failure
4 00000020 PCMIN-2 Major Frame Failure
*

```

6.2.3.4 (M) .HELP

The .HELP command displays a list showing a summary of the serial "dot" commands and parameters supported by the R/R as listed in [Table 6-3](#).

Example

```

.HELP
.
. ASSIGN [destination-ID] [source-ID]
. BBLIST {type}
. BBREAD {block identifier}
. BBSECURE {block identifier}
. BIT
. CONFIG
. COPY [source drive ID] [destination drive ID]
. CRITICAL [n [mask]]
. DATE
.
. (full list from Table 6-3)
.
. TMATS {mode} [n|ALL]
*

```

6.2.3.5 (M) .IRIG106

The .IRIG106 command returns the release version number of the Chapter 6 R/R C&C mnemonics that the R/R is supporting. Because this command was introduced in IRIG 106-07, R/Rs supporting earlier releases should respond with the invalid command error message (E00). The .IRIG-106 command is a synonym for the .IRIG106 command.

Example

```

. IRIG106
7
*
. IRIG-106
7
*

```

Note : This example indicates that the recorder C&C module is compatible with IRIG 106-07

6.2.3.6 (M) .RECORD [filename] [channel-group ID] [drive ID]

The .RECORD command starts a new recording. The optional file name parameter is an ASCII string with up to 11 characters, beginning with an alphabetic character, and with no spaces or asterisks. If the file name parameter is omitted, the filename will be of the form "file*n*", where *n* is the file number. The recording will continue until the recording drive is full or until

the .STOP command is issued. The optional drive ID is for recorder systems with multiple drives.



6.2.3.7 (M) .SETUP [n]

The .SETUP command chooses one of 16 pre-defined setups stored in the R/R. The optional parameter is a one- or two-digit decimal setup number from 0 to 15. The current setup may be displayed by omitting the setup number parameter.

The .SETUP command shall return a text "RMM [drive-ID]" if the currently applied setup is retrieved from the removable memory module (RMM).

The .SETUP command shall return a text "NONE" if the currently applied setup is not saved.

The last applied setup number used by the .SETUP command shall be stored in the non-volatile memory of the R/R and automatically used as the default setup after the next power cycle of the R/R.

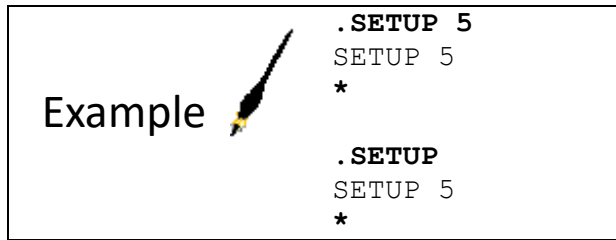

6.2.3.8 (M) .STATUS

The .STATUS command displays the current state of the R/R and two counts. The first is the total number of non-critical warning bits currently set and the second is the total number of critical warning bits currently set. If the R/R is in any state other than FAIL, IDLE, BUSY, or ERROR, the command also displays a progress percentage, the meaning of which is dependent on the specific state. Whenever the R/R is transitioning between states and the transition is not instantaneous, the .STATUS command will return the BUSY state. The ERROR state is entered when the currently executing command does not complete successfully. For example, when a .FIND command is unable to locate the specified position on the drive, the R/R transitions to the ERROR state. [Table 6-5](#) shows the various states by numerical code and describes the meaning of the progress percentage for each state. An ASCII "S" character identifies a .STATUS command response.

Table 6-5. Recorder States		
State Code	State Name	Progress Description
00	FAIL	---
01	IDLE	---
02	BIT	Percent complete
03	ERASE	Percent complete

04	DECLASSIFY	Percent complete
05	RECORD	Percent media recorded
06	PLAY	Percent recording played
07	RECORD & PLAY	Percent media recorded
08	FIND	Percent complete
09	BUSY	---
10	ERROR	---

```

Example 
    .STATUS
    S 03 0 0 84%
    *
    .STATUS
    S 01 0 0
    *
    
```

6.2.3.9 (M) .STOP [*mode*] [stream ID] [drive ID]

The .STOP command stops a recording, playback, or both. The optional mode parameter may be either the word RECORD or the word PLAY. If the optional mode parameter is not specified, both recording and playing (or either of the two modes if the other is not active) will be stopped. Using the parameter enables either recording or playing to be stopped without affecting the other, when both are active.

```

Example 
    .STOP
    *
    
```

```

Example 
    . S 07 0 0 26%
    *
    .STOP PLAY
    *
    .STATUS
    S 05 0 0 26%
    *

    The current state can be displayed with the status command.
    
```

```

Example 
    .STATUS
    S 01 0 0
    *
    .STOP
    E 02
    *

    The .STOP command returns an error if the R/R is
    not in the appropriate state.
    
```

6.2.3.10 (M) .TIME [start-time]

The .TIME command displays or sets the internal system's time. The optional start-time parameter is formatted as shown in the example below. Without a parameter, this command displays the current system time.

Example		.TIME
		TIME 001-23:59:59.123 *

Example		.TIME 123-13:01:35
		TIME 123-13:01:35.000 *
To set the time, enter a value expressed in days, hours, minutes, seconds, and milliseconds.		

Example		.TIME 123-
		TIME 123-00:00:00.000 *
.TIME 15:31		
TIME 000-15:31:00.000 *		
Note: Trailing values and punctuation may be omitted (zero is default).		

6.2.3.11 (M) .TMATS {mode} [n]

The .TMATS command provides a vendor-independent mechanism for loading a setup file into the R/R and retrieving a setup file from the R/R. The required mode parameter must be one of the following seven words: WRITE, READ, SAVE, GET, DELETE, VERSION, or CHECKSUM.

Writing or reading a TMATS file transfers the file between the external host and the R/R's internal volatile memory buffer. Saving or getting a TMATS file transfers the file between the R/R's internal volatile memory buffer and the R/R's internal non-volatile setup file storage area. To store a new setup file in the R/R, the .TMATS WRITE command is first used to transfer the file to the recorder, followed by a .TMATS SAVE [n] command to store the file in non-volatile memory. The numeric setup file number parameter is not valid with the .TMATS WRITE command. When saving the file to non-volatile memory, the optional setup file number parameter may be entered to designate a specific setup number (see the .SETUP command). If the setup files number parameter is not specified with the .TMATS SAVE command, the file number defaults to setup 0.

- a. The .TMATS GET [n] command performs the inverse of the .TMATS SAVE command, retrieving the specified or default (0) file from non-volatile to volatile memory within the R/R. If [n] is omitted, it shall retrieve the active TMATS.

- b. The .TMATS READ command transfers the file currently in the R/R’s volatile setup file buffer to the host.
- c. Termination of the .TMATS WRITE command string is unique. All other command strings terminate with the first occurrence of a carriage return and line feed sequence. The .TMATS WRITE command string does not terminate until the occurrence of a carriage return and line feed pair followed by the word END and another carriage return and line feed pair.
- d. The .TMATS DELETE mode accepts either a single setup number [n] or the keyword ALL.
- e. The .TMATS VERSION command returns the version attribute from the current setup record.
- f. The .TMATS CHECKSUM [n] command returns a message digest of the entire specified or default (0) TMATS record excluding only the G\SHA code name, if present. The message digest shall be calculated in accordance with (IAW) Federal Information Processing Standards Publication 180-4¹, algorithm “SHA-256.” The message digest is a string of 64 lower-case hexadecimal characters, prefixed with the constant string “2-” to designate the algorithm. If the TMATS includes a G\SHA code name, all text between the “G\SHA” and the following semicolon, inclusive, shall be discarded for the purposes of digest calculation.

Example 

```

.TMATS WRITE
G\DSI\N=18;
G\DSI-1:TimeInChan1;
G\DSI-2:VoiceInChan1;
G\DSI-3:1553Chan01;
:
:
P-8\IDC8-1:0;
P-8\ISF2-1:ID;
P-8\IDC5-1:M;
END
*
                    
```

The .TMATS WRITE command places the file into the volatile buffer of the R/R and applies the setup.

Example 

```

.TMATS READ
G\DSI\N=18;
G\DSI-1:TimeInChan1;
G\DSI-2:VoiceInChan1;
G\DSI-3:1553Chan01;
:
:
P-8\IDC8-1:0;
P-8\ISF2-1:ID;
P-8\IDC5-1:M;
*
                    
```

¹ National Institute of Standards and Technology. “Secure Hash Standard (SHS).” FIPS PUB 180-4. August 2015. May be superseded by update. Retrieved 3 July 2019. Available at <http://nvlpubs.nist.gov/nistpubs/FIPS/NIST.FIPS.180-4.pdf>.

The .TMATS READ command returns the file currently in the volatile buffer.

Example  **.TMATS SAVE 3**
*
The .TMATS SAVE command stores the file in the volatile buffer to the designated non-volatile file memory in the R/R.

Example  **.TMATS GET 3**
*
The .TMATS GET command retrieves the designated file from non-volatile file memory in the R/R and puts it in a buffer that can be read by the user. The retrieved setup will also be applied.

Example  COMMENT: * G-Group - General Information *; G\PN:TEST_XYZ;
G\TA:F16; G\106:09; G\OD:10-22-2009;
COMMENT: Contact information;
G\POC\N:1;
G\POC1-1:Wile E. Coyote;
G\POC2-1:ACME Corp;
G\POC3-1:123 Road Runner Way Phoenix AZ 99999; G\POC4-1:(555)555-5555; G\DSI\N:1; G\DSI-1:RF_DATA_SOURCE;
G\SHA:0; G\DST-1:RF; G\SC:U;

.TMATS CHECKSUM 1
2-3af058dc20fd35b82a1beba4de0ed6efa6e5e0ebefe8625494359180d8d16cd
*

The .TMATS CHECKSUM [n] command returns the SHA-256 256-bit (32 bytes, 64 hexadecimal characters) message digest of the complete TMATS file stored in position [n] in the recorder.

COMMENT: * G-Group - General Information *; G\PN:TEST_XYZ;
G\TA:F16; G\106:09; G\OD:10-22-2009;
COMMENT: Contact information;
G\POC\N:1;
G\POC1-1:Wile E. Coyote;
G\POC2-1:ACME Corp;
G\POC3-1:123 Road Runner Way Phoenix AZ 99999; G\POC4-1:(555)555-5555; G\DSI\N:1; G\DSI-1:RF_DATA_SOURCE; G\SHA:2-3af058dc20fd35b82a1beba4de0ed6efa6e5e0ebefe8625494359180d8d16cd; G\DST-1:RF; G\SC:U;

.TMATS CHECKSUM 1
2-3af058dc20fd35b82a1beba4de0ed6efa6e5e0ebefe8625494359180d8d16cd
*

Note the addition of the G\SHA entry does not alter the checksum.

6.2.4 Optional Command Descriptions

Commands are listed alphabetically.

6.2.4.1 (O) .ASSIGN [destination-channel ID] [source-channel ID]

The .ASSIGN command shall be used for assigning output channels to source input channels. The source IDs are composed from the channel type of the source as defined in [Chapter 9](#) parameter Command Data Type - a “-” character and the sequence number of that type of channel (e.g., “PCMIN-3” for the 3rd PCM input channel). The destination IDs are composed similarly - but with an “OUT” tag in the Channel Type, instead of an “IN” tag. Use the keyword “NONE” in place of source ID if a channel is to be unassigned. The command with the destination ID parameter only should return the actually assigned source ID; without any parameters it should return the full list of assignments.

Example  `.ASSIGN PCMOUT-6 PCMIN-2`
 *
 Means: PCM input channel 2 will be assigned to PCM output channel 6

Example  `.ASSIGN PCMOUT-6`
`PCMM-2`
 *
 Means: PCM input channel 2 is currently assigned to PCM output channel 6

Example  `.ASSIGN PCMOUT-1`
`NONE`
 *
 Means: No channels are assigned to PCMOUT-1

6.2.4.2 (O) .BBLIST {type} [drive-ID]

A .BBLIST command shall be utilized to return the unsecured bad block identifiers (any ASCII text, one identifier per line) from the drive. A .BBLIST command is only valid following a declassify command. The *type* shall be provided indicating which type of bad block list is to be returned. If *type* = “unsecured”, .BBLIST shall return a list of unsecured bad blocks. If *type* = “secured”, .BBLIST shall return a list of secured bad blocks.

Example  `.BBLIST`
`1234`
`5678`
`:`
`fff`
`*`

6.2.4.3 (O) .BBREAD {block identifier} [drive-ID]

A .BBREAD command shall be utilized to return the raw data from the specified bad block in ASCII hexadecimal format. The block identifier shall be provided for the bad block to be read.

Example 	.BBREAD 5678
	00040000 *

6.2.4.4 (O) .BBSECURE {block identifier} [drive-ID]

A .BBSECURE command shall be utilized to mark an unsecured bad block as being secured. A block that has been identified as secured shall never be used for any subsequent data recording. Secured bad blocks shall be removed from an unsecured bad block identifier list. The block identifier shall be provided for the block to be secured.

Example 	.BBSECURE 5678
	*

6.2.4.5 (O) .BIT

The .BIT command runs the BIT on the R/R. The prompt is returned immediately after the test is started. The .BIT command is only valid in the IDLE, ERROR, and FAIL states. During the BIT, the user must periodically check the status until the test is complete. While in BIT mode, the percent completion is shown with the .STATUS command. The result of the .BIT command is go/no-go status indicated by the end state. If the system returns to the IDLE state, the BIT was successful. If the system goes to the FAIL state, the BIT failed and further system-specific diagnostics are required. The ASCII “S” in the response is the identifier of a .STATUS response.

Example 	.BIT
	*
	.STATUS
	S 02 0 0 21%
	*
	.STATUS
	S 02 0 0 74%
	*
	.STATUS
	S 01 0 0
	*

6.2.4.6 (O) .CONFIG

This command retrieves a channel configuration summary (vendor-defined text format). The command cannot include the ASCII “*” character.

6.2.4.7 (O) .COPY [source-drive-ID] [destination-drive-ID]

The .COPY command can be used for copying the content from the source drive to the destination drive.

6.2.4.8 (O) .DATE [start-date]

The .DATE [start-date] command displays or sets the internal system date. The optional start-date parameter is formatted as shown in the example below. Without a parameter, this command displays the current system date. The timestamps recorded with user data are derived from this clock. The date shall be set in year-month-day format according to ISO 8601.

<p>Example </p>	<pre>.DATE DATE 2002-12-31 *</pre>

6.2.4.9 (O) .DISMOUNT [drive-ID]

The .DISMOUNT command disables and, if necessary, removes power from the active recording drive. The drive may be removed only after this command is issued.

<p>Example </p>	<pre>.DISMOUNT *</pre>

<p>Example </p>	<pre>.DISMOUNT E 03 *</pre>
	<p>Note: If a failure occurs, an error message is displayed before the prompt</p>

6.2.4.10 (O) .DRIVE

The .DRIVE command gives a list of available drives and volumes defined in the R/R setup record.

6.2.4.11 (O) .DUB [location]

The .DUB command is identical to the .PLAY command, except that it specifies the use of the internal playback clock to retrieve the recorded data.

<p>Example </p>	<pre>.DUB *</pre>

6.2.4.12 (O) .ERASE [drive-ID] [Volume Name]

The .ERASE command logically erases all data on the drive, allowing for recording to begin at the beginning of media.

	<p>This command does not provide assurance that the device is in any way sanitized. Data may still be recoverable.</p>
---	--

The prompt is returned immediately after the operation is started. During erase, the user must periodically check the status until the operation is complete. While in ERASE state, the percent completion is shown with the .STATUS command.

```

Example 
.ERASE
*
.STATUS
S 03 0 0 23%
*
.STATUS
S 03 0 0 84%
*
.STATUS
S 01 0 0
*
    
```

6.2.4.13 (O) .EVENT [event ID]

The .EVENT command adds an event entry as defined in the recording event definitions within the setup record. An event command is defined as a Recorder “R” event type. The event ID defined in the setup record is provided with the command. All other attributes defined with the event ID are applicable so that the command result is an event packet entry for the given event ID. The event command without an event ID shall return a list of captured events. The list shall be <list #><event ID><event time>

```

Example 
.EVENT 5
*
    
```

```

Example 
.EVENT
1 005 00:13:58.109
2 005 00:14:11.106
3 005 01:01:06.677
*
    
```

6.2.4.14 (O) .ETOLOOP [instream-ID] [outstream-ID]

The .ETOLOOP command is used to put the R/R into looping live data mode. Live data does not utilize the drive. Data is moved from the input streams directly to the output streams. The output data rates are derived from the data rate of the corresponding input stream. The R/R may or may not be in data recording mode.

6.2.4.15 (O) .FIND [value [mode]]

The .FIND command is used to report the current record-and-play point or to set the play point to the desired location within the recorded data. The desired location can be expressed in a number of different formats or “modes:” time or blocks. When the command is entered without any parameters, the R/R returns the current record point and current play points, using the current default mode. The default mode is declared each time a mode parameter is supplied with the .FIND command or the .REPLAY command. Thereafter, the mode parameter may be omitted and the R/R will use the default mode. The mode keywords are TIME and BLOCKS.

The location specified in the value parameter of the `.FIND` command can be numeric or one of six keywords: BOM (beginning of media), BOD (beginning of data), EOD (end of data), EOM (end of media), BOF (beginning of file), and EOF (end of file). These keywords may be used with or without a mode parameter. Numeric location values, whether accompanied by the mode keyword or not, must be valid for the specified or default mode. Blocks are entered as decimal integer numbers. Time is entered as specified in Paragraph [6.2.1](#) item [j](#).

Example 

```
.FIND
F 1022312 BOD
*
```

Note: Display the current record point and play point. The default mode is blocks.

Example 

```
.FIND 15:33:12 TIME
*
.STATUS
S 08 0 0 41%
*
.STATUS
S 08 0 0 84%
*
.STATUS
S 01 0 0
*
.FIND
F 102-16:18:27.000 102-15:33:12.000
*
```

Note: Find a specific time in the recorded data.

6.2.4.16 (O) `.LOOP` [start/stop]

The `.LOOP` command is used to either start read-after-write mode (which begins recording and simultaneously playing back the recorded data) or stop read-after-write mode. The replayed data is read back from the recording drive. If the R/R is already recording when the `.LOOP` command is issued, the command starts the playback at the current record point without affecting the recording.

Example 

```
.STATUS
S 01 0 0
*
.LOOP
*
.STATUS
S 07 0 0 35%
*
```

6.2.4.17 (O) `.MEDIA` [drive-ID]

The `.MEDIA` command displays the media usage summary. It shows the number of bytes per block, the number of blocks used, and the number of blocks remaining, respectively.

Example		.MEDIA
		MEDIA 32768 1065349 6756127 *

6.2.4.18 (O) .MOUNT [drive-ID]

The .MOUNT command applies power and enables the device for recording. For systems with multiple memory canisters or media cartridges, the effect of the .MOUNT command on each canister or media cartridge is defined in advance with vendor-specific commands.

Example		.MOUNT
		*

6.2.4.19 (O) .OUT_CRATE [rate [type]]

The .OUT_CRATE command controls the output rate of periodic copies of the currently active configuration/setup record (TMATS) or the checksum of the currently active configuration/setup record. Both variants (the full TMATS record or the checksum) are sent using Computer-Generated Data, Format 4 packets IAW [Chapter 11](#) Subsection 11.2.7.5; note that these records are treated like any other packet and will be written to the recording media as well as (potentially) be published.

Both variants (full and checksum) may be active concurrently, with the same or different rates.

If present, the rate is specified in seconds and indicates the desired interval between copies. An explicit value of 0 disables the production of the copies. This standard does not dictate the set of acceptable values for the period, but in the event that an implementation cannot precisely match the requested period, then the following approach shall be followed: if the period requested is less than the shortest value supported by the implementation, then the shortest implementation value shall be used; otherwise the greatest supported value less than or equal to the requested value shall be selected.

If the rate is omitted, the value of the TMATS R-x\HRATE-n and R-x\CRATE-n attribute are used, depending on whether the “FULL” or “HASH” variant is selected by the *type* parameter.

If the type parameter is omitted or is specified as the literal text “HASH”, then the checksum of the active setup record using the algorithm defined in Subsection [6.2.3.11.f](#) is written using a packet IAW [Chapter 11](#) Subsection 11.2.7.5; if “FULL” is specified then the complete text of the TMATS record is produced IAW [Chapter 11](#) Subsection 11.2.7.5.

6.2.4.20 (O) .PAUSE [stream-id]

The .PAUSE command stops the replay operation. If parallel recording is being performed, it continues. If no play position is moved in between, the .RESUME command can be used to continue replay. The .PAUSE command can also be used to stop only the replay while the recording continues (in this case, a new replay should be started with a new .PLAY command). If the stream ID is present it will pause only the channels defined by the .STREAM command.



6.2.4.21 (O) .PLAY [*location*] [*speed*] [*drive ID*]

The .PLAY command starts a playback of the data at either the current play point or at the location specified in the optional parameter with the command. The current play point is defined to be the drive location immediately following the most recently played data. If no .PLAY command has been issued since R/R power-on, the current play point is the beginning of data. The location parameter has two forms: [*block_number*] and [*filename* [*block_offset*]]. If the first character of the location parameter is numeric, the entire parameter must be numeric, specifying the block number address at which to start the playback. When the first character of the location parameter is alphabetic, the parameter is the filename to play back. It may have a second, optional parameter specifying the numeric 0-origin block offset into the named file. Use the .FIND command, which allows positioning the play point wherever necessary, to begin playing at a location other than a block number or file. The optional [*speed*] parameter specifies the replay speed, if other than real-time replay speed is required. The syntax of the speed specification is: **N* or /*N* (e.g., *5 for 5 times faster, /8 for 8 times slower replay).

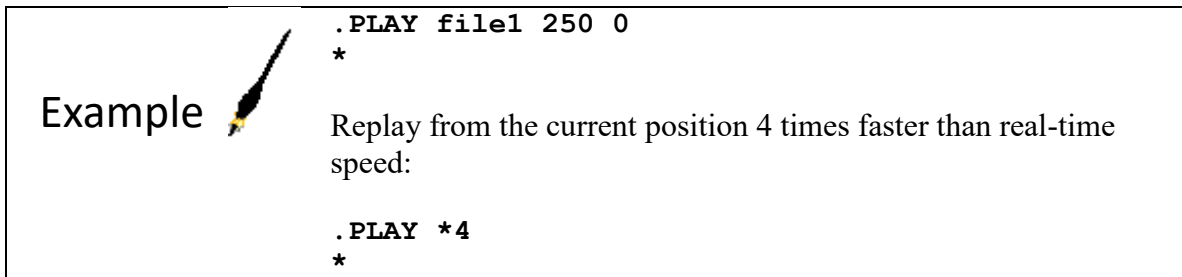

6.2.4.22 (O) .PUBLISH [*keyword*] [*parameter list*]

The .PUBLISH command shall be utilized for configuring, starting, and stopping UDP uni-, multi-, or broadcast of live data in Chapter 11 packet format over any IP interface to the R/R. The following keywords are allowed.

.PUBLISH START *IPAddressPortAddressstream-definition*

(Start the streaming of the specified stream definition to the destination address.)

If a new list is defined for the same IP address and PortAddress combination, this will ADD the channels of the new stream definition, not replace them.

.PUBLISH STOP *stream-definition*

(Stop streaming of the specified stream definition.)

The *IPAddressPortAddress* parameter defines the destination IP address and the port number of the UDP broadcast.

If the same IP address and PortAddress combination are defined, this will REMOVE only the listed channels of the stream without affecting the other channels.

The *stream-definition* parameter can be:

- A stream ID previously defined using the .STREAM command;
- A channel ID list as defined in the description of the .STREAM command.

The .PUBLISH command without any parameter returns the streaming channel IDs and their destinations.

Example 

```
.PUBLISH START 192.145.255.255 1234 ALL
*
.PUBLISH START ::FFFF:C091:FFFF 1234 ALL
*
.PUBLISH
192.145.255.255 1234 ALL
*
.PUBLISH STOP ALL
*
.PUBLISH START 192.145.255.255 1234 1-12 18
*
.PUBLISH
192.145.255.255 1234 1-12 18
192.146.255.255 2345 13-17
*
```

6.2.4.23 (O) .PUBLISH_CFG {keyword}

The .PUBLISH_CFG command sets or resets modes related to the .PUBLISH commands (including the .PUBLISH_TCP variant). By default, unless otherwise specified, all modes default to being disabled. Valid keywords are shown in [Table 6-6](#).

Table 6-6. PUBLISH_CFG Keywords		
Enable Keyword	Disable Keyword	Description
BLKFMT1	NOBLKFMT1	Controls whether Format 1 setup records should be blocked from being published.
STREAMID	NOSTREAMID	Controls reporting currently active channels being published.

If BLKFMT1 mode is set, then Computer-Generated Data, Format 1 packets sent on Channel ID 0x0 (e.g., the setup record required to be the first packet in file compliant with [Chapter 11](#)) will be blocked and not sent (published).

If STREAMID mode is set, then a Computer-Generated Data, Format 4 packet IAW [Chapter 11](#) Subsection 11.2.7.5 will be generated when the channels being output by the .PUBLISH command change, including the change from “not PUBLISHING” to “PUBLISHING”. Note that the channel in which the Format 4 packet is placed (channel 0x0) must be included in the active stream definition for the change packet to be published.

6.2.4.24 (O) .PUBLISH_FILE [keyword][parameter list]

The .PUBLISH_FILE command shall be utilized for configuring, starting, and stopping UDP uni-, multi-, or broadcast of recorded data from a medium in Chapter 11 packet format over any IP interface of the R/R.

.PUBLISH_FILE START/STOP IPaddressPortAddress file-name [start-time] [stop-time] [speed] stream-definition

The first parameter is mandatory and must be either START or STOP.

The IPaddressPortAddress parameter defines the destination IP address and the port number of the UDP broadcast.

The optional start-time parameter specifies the absolute time of the first packet to be sent out from the file.

The optional stop-time parameter specifies the absolute time of the last packet to be sent out from the file.

The optional speed specifies the speed of the UDP broadcast. It can be one of the following keywords:

FULL: maximum speed the R/R and media are capable;

REALTIME: near-real-time streaming - as close as possible to the original live data streaming;

MBPS <n>: with a specified average bit rate in megabits per second.

The *FileName* parameter defines the file to be sent out as UDP stream.

The *stream-definition* parameter can be:

- A stream-ID defined previously in the .STREAM command;
- A channel-ID list as defined in the description of the .STREAM command.

Example 	<code>.PUBLISH_FILE START File1.ch10 Stream2</code>
	<code>*</code>
	<code>.PUBLISH_FILE STOP File1.ch10</code>
	<code>*</code>
	<code>.PUBLISH_FILE</code>
	<code>File1.ch10 192.145.255.255 1234 1-12 18</code>
<code>*</code>	

6.2.4.25 (O) .PUBLISH_TCP [keyword][parameter list]
[TBD]

6.2.4.26 (O) .QUEUE [keyword] [parameter]

The .QUEUE command is used to specify a recorded data file or defined data event at which to begin the next replay. Replay must be stopped prior to issuing the .QUEUE command. Keyword options are either event or file. The parameter option represents either the event or file number from which to begin replay.

6.2.4.27 (O) .RCC-106

The .RCC-106 command is a synonym for the .IRIG106 command

6.2.4.28 (O) .REPLAY [location [mode]]

The .REPLAY command initiates a repeated playback from the current play point to the end point specified in the command, using an internal clock to “gate” the data. The syntax of the endpoint parameter is identical to that of the .FIND command.

6.2.4.29 (O) .RESET

The .RESET command performs a software-initiated reset of the R/R, returning the R/R to the power-on state. The effect shall be identical to a power cycle.



6.2.4.30 (O) .RESUME [stream-id]

The .RESUME command can be used to continue the replay from the location where it was stopped by the .PAUSE operation - with the replay speed specified at the last .PLAY command. If the play position was moved with the .FIND command since the .PAUSE command was used, the replay cannot be continued by the .RESUME command - a new .PLAY command should be issued. If the stream-id is present it will pause only the channels defined by the .STREAM command.

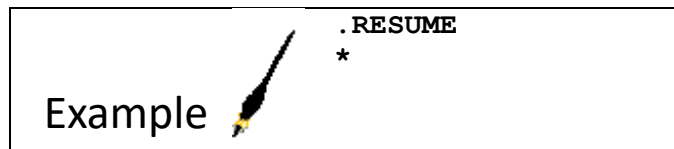

6.2.4.31 (O) .SANITIZE [drive-ID]

The .SANITIZE command erases all recorded data using the sanitization procedure specific to that recorder.



This command will permanently erase all recorded data. Data cannot be recovered once this command has been executed! Note that this command makes no representation that any given recorder’s sanitization procedure is appropriate for a particular application. Rather, if the recorder has an appropriate procedure, then this command initiates it.

The prompt is returned immediately after the operation is started. During sanitize, the user must periodically check the status until the operation is complete. While in the SANITIZE state, the percent completion is shown with the .STATUS command.

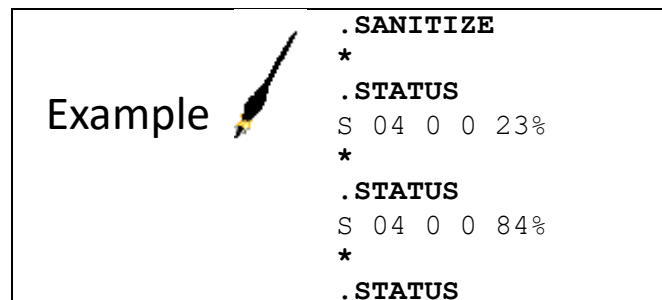

S 01 0 0 *

6.2.4.32 (O) .STREAM [stream ID] [channel ID list]

The .STREAM command displays specified or all stream channel assignments.

6.2.4.33 (O) .VERBOSE [*mode*]

The .VERBOSE command enables or disables verbose mode with the ON or OFF keywords.

6.2.4.34 (O) .VOLUME

The .VOLUME command gives a list of available volumes defined in the TMATS.

6.2.5 Command Validity Matrix

[Table 6-7](#) identifies the R/R states in which each of the serial commands is valid. The legend at the bottom of the table explains the matrix entry codes. Two codes, 3 and 4, identify states in which the associated command may or may not be valid due to system-specific implementation. The R/R users should assume that a command is not supported in a system-specific state (code 3 or 4) unless the specific R/R's interface control document assures that support is provided.

Table 6-7. Command Validity Matrix												
Command	State											
	BUILT-IN TEST	BUSY	DECLASSIFY	ERASE	ERROR	FAIL	FIND	IDLE	PLAY	POWER ON	RECORD	RECORD & PLAY
.ASSIGN					X	X		X			X	
.BBLIST, .BBREAD, .BBSECURE								1				
.BIT					X	X		X				
.CONFIG	X		X	X	X	X	X	X	X		X	X
.CRITICAL	2		2	2	2	2	2	2	2		2	2
.DATE	2		2	2	2	2	2	2	2		2	2
.DISMOUNT					3			3				
.DRIVE	X		X	X	X	X	X	X	X		X	X
.DUB					X			X			X	
.ERASE					X			X				
.EVENT (*)	X				X	X	X	X	X		X	X
.FILES	X				X	X	X	X	X		X	X
.FIND					X			X			X	
.HEALTH	X		X	X	X	X	X	X	X		X	X
.HELP	X		X	X	X	X	X	X	X		X	X
.IRIG106	X	X	X	X	X	X	X	X	X		X	X

.LOOP					X			X			X	
.MEDIA	X				X	X	X	X	X		X	X
.MOUNT					3			3				
.PAUSE (*)					X			X			X	
.PLAY (*)					X			X			X	
.PUBLISH (*)					X			X	X		X	X
.PUBLISH_CFG					X			X				
.OUT_CRATE					X			X	X		X	X
.QUEUE												
.RECORD (*)					X		X	X	X			
.REPLAY					X			X			X	
.RESET	X	X	X	X	X	X	X	X	X		X	X
.RESUME (*)					X			X			X	
.SANITIZE (*)					X			X			X	
.SETUP	2		2	2	2	2	2	2	2		2	2
.STATUS	X	X	X	X	X	X	X	X	X		X	X
.STOP							X		X		X	X
.STREAM	X		X	X	X	X	X	X	X		X	X
.TIME	2		2	2	2	2	2	2	2		2	2
.TMATS					X			X				
.VOLUME	X		X	X	X	X	X	X	X		X	X
Legend												
X = Always valid.												
1 = Only valid after declassify command execution has completed.												
2 = Query function always valid. Changing masks, setup, or time only valid in IDLE or ERROR.												
3 = MOUNT and DISMOUNT only valid if not mounted or dismounted, respectively.												
Commands marked (*) may have implementation-specific restrictions.												

6.2.6 Required Command Subset

[Table 6-8](#) identifies the minimum subset of commands that must be implemented for each R/R type to be compliant with this standard.

Table 6-8. Required Commands			
Command	Recorder Type		
	Tape	Solid-State	Disk
.BIT	M	M	M
.CRITICAL	M	M	M
.DATE	M	M	M
.DECLASSIFY	O	M	O
.DISMOUNT	M	M	M
.ERASE	M	M	M
.FILES	O	M	M

.HEALTH	M	M	M
.HELP	M	M	M
.IRIG106	M	M	M
.MEDIA	M	M	M
.MOUNT	M	M	M
.RECORD	M	M	M
.RESET	M	M	M
.SETUP	M	M	M
.STATUS	M	M	M
.STOP	M	M	M
.TIME	M	M	M
.TMATS	M	M	M
Legend			
M= Mandatory O = Optional			

6.3 MIL-STD-1553 Remote Terminal Command and Control

As of RCC 106-17, this section is moved to [Appendix 6-A](#).

6.4 Discrete Command and Control

Any R/R that implements discrete C&C shall implement the functions described herein. Required discrete control functions are noted in [Figure 6-9](#).

Description
RECORD
ERASE
SANITIZE
ENABLE
BIT

Figure 6-9. Required Discrete Control Functions

6.4.1 Control and Status Lines

Five contacts for discrete control and five lines for indicating status shall be provided. All the lines are “active low”: grounding a control line (or causing the indicator line to go to ground) referenced to the recorder’s ground activates the function as shown in [Figure 6-10](#). Note that the circuit shown in [Figure 6-10](#) is for reference only, and specific installations may require alternative arrangements that are beyond the scope of this standard.

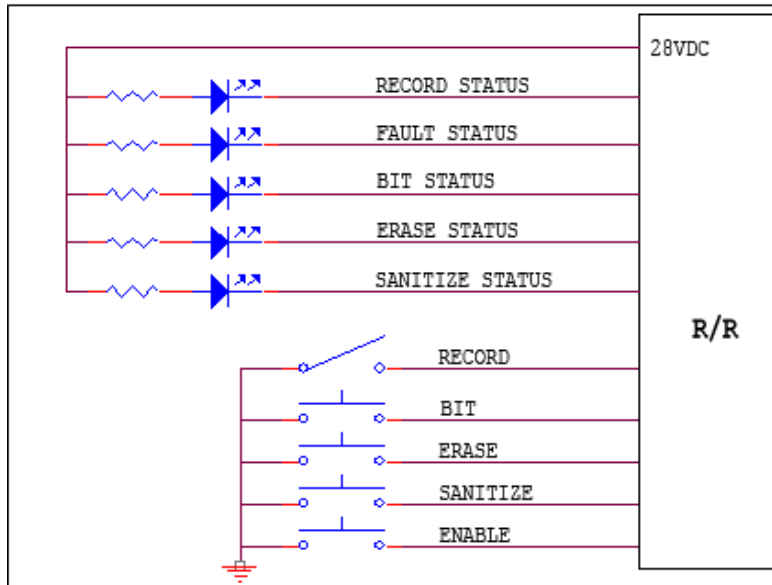

Figure 6-10. Discrete Control and Indicator Functional Diagram

6.4.1.1 Activation

All control inputs are activated by being brought to 0.55 volts (V) or less. Inputs using momentary switches must be active for 0.5 seconds for the associated command to be invoked. All status outputs are set to be “ON” by the R/R bringing the voltage to 0.55 V or less. The “OFF” state is designated by the output being open circuit. When “ON”, the current in the circuit shall not exceed 60 milliamps (mA).

6.4.1.2 Controls

BIT Command: Activated by a momentary switch, this discrete control commands the recorder to start the BIT procedure.

Enable Command: Activated by a momentary switch, this discrete control must be asserted simultaneously with either the ERASE or SANITIZE discrete for that control to operate.

Erase Command: Activated by a momentary switch, this discrete control commands the recorder to erase its user data and file directory memory provided the ENABLE switch is also activated.

Record Command: Activated by a toggle switch, this discrete control commands the recorder to start recording. Recorder will remain in this mode for the duration that the switch is active (i.e., closed).

Sanitize Command: Activated by a momentary switch, this discrete control causes the recorder to start the SANITIZE procedure provided the ENABLE switch is also activated.

BIT Status: The built-in test is running.

Erase Status: The media is erased or in the process of being erased.

Fault Status: The R/R is not ready or a critical warning has been posted.

Record Status: The R/R is recording.

Sanitize Status: The media is sanitized or is in the process of being sanitized.

6.4.2 Voltage

28VDC auxiliary voltage output shall be provided from the discrete/control port (250 mA max, short circuit protection). A ground reference point shall be provided.

6.4.3 Status Updates

The status reflected by the output lines shall be updated to match the actual status of the R/R at least once every 2 seconds. Whenever a status is activated (“ON”), it shall remain ON for a minimum interval not less than one second; status lines may flash (with a duty cycle of 500 milliseconds [ms] ON, 500 ms OFF) to indicate that the R/R is in the process of accomplishing the related status. [Table 6-9](#) summarized the meanings associated with each status line.

Status Line	On	Flash	Off
ERASE	Media erased.	Media is being erased.	Media is not erased.
RECORD	R/R is recording.	-	R/R is not recording.
FAULT	R/R is not ready, or any of the critical warning exists.	-	R/R is running properly. No critical warning.
BIT	Built-in test running.	-	Built-in test is not running.
SANITIZE	Media sanitized.	Media sanitization is in progress.	Media is not sanitized.

6.5 Commands for RMM Devices

6.5.1 Mandatory Commands

The mandatory commands for all RMM devices are listed in [Table 6-10](#). Additional commands that are mandatory for all RMM devices that support declassification are listed in [Table 6-11](#). Commands that are mandatory for RMM devices that support the Ethernet host platform interface via Telnet are listed in [Table 6-12](#), with optional Ethernet commands listed in [Table 6-13](#).

Command	Parameters	Description
.BIT		Runs all of the RMM BITs.
.CRITICAL	[n [mask]]	Specifies and views masks that determine which of the .HEALTH status bits are critical warnings.
.DATE	[start-date]	Specifies setting or displaying date from RMM.
.ERASE		Erases the RMM media.
.HEALTH	[feature]	Displays detailed status of the RMM.
.IDENTIFY		Queries the RMM for solid-state memory identification and firmware version.

Table 6-10. Mandatory Commands (All Interfaces)

Command	Parameters	Description
.INITIALIZE		Initializes RMM internal components.
.IRIG106		Retrieves the IRIG-106 supported version number.
.MEDIA P		Queries the RMM for information about the physical media of the RMM and the transfer limits for the required physical input/output (I/O) commands.
.STATUS		Displays the current RMM status.
.TIME	[start-time]	Displays or sets the internal system time.

Table 6-11. Additional Mandatory Commands for Declassification

Command	Parameters	Description
.BBLIST		Directs the RMM to retrieve the bad block list.
.BBLIST R		Retrieves the bad block list from the RMM.
.BBREAD	{block identifier}	Returns contents of specified block in ASCII hexadecimal byte format.
.BBREAD P	{block identifier}	Directs the RMM to initiate a physical block read of the specified physical block identifier.
.BBREAD D		Retrieves the data from the physical block. See the .MEDIA P command for information. Data is returned in binary format.
.BBSECURE	{block identifier}	Marks an unsecured bad block as secure.
.DECLASSIFY		Initiates command as specified by user specification or user CONOP overwrite procedures.
.PBWRITE P	{block identifier}	Directs the RMM to initiate a physical block write of the specified physical block identifier.
.PBWRITE D		Writes the data to the physical block in binary format. See the .MEDIA P command for information.
.SANITIZE		Initiates a memory clear and identification of bad memory blocks.

Table 6-12. Additional Mandatory Commands for Ethernet Interface

Command	Parameters	Description
.MEDIA E		Queries the RMM about which protocols it supports.
.RMMIP		Displays RMM IP address and associated settings. Mandatory only with Ethernet host platform interface.
.RMMIP	keyword [parameter]	Displays and controls RMM IP addressing. Mandatory only with Ethernet host platform interface.
.TIME	[PTPSTATUS PTP]	Displays and controls the IEEE 1588 Precision Time Protocol (PTP) (if implemented).
.TMATS	GET	Recovers the recorder setup configuration file (RSCF) from the RMM storage.
.TMATS	READ	Displays the RSCF.

Table 6-12. Additional Mandatory Commands for Ethernet Interface

Command	Parameters	Description
.TMATS	SAVE [n]	Saves the RSCF using n to form file name.
.TMATS	WRITE	Uploads an RSCF.

Table 6-13. Non-Mandatory Commands for Ethernet Interface

Command	Parameters	Description
.RMMFRAME		Displays the current and largest maximum frame size.
.RMMFRAME	Frame size	Sets the maximum frame size.
.TCPPTS		Displays a comma-separated list of the TCP port numbers used for the Telnet, File Transfer Protocol (FTP), and iSCSI services.
.TCPPTS	port1,port2,port3	Sets the ports used for the network services.

The RMM .HEALTH command response is presented in [Table 6-14](#).

Table 6-14. Removable Memory Module .HEALTH Command Response

	Bit	Mask	Description
RMM	0	01	Bit failure
	1	02	Setup failure (unable to set the time or date properly)
	2	04	Operational failure (I/O error, media error, etc.)
	3	08	Low or dead battery warning
	4	10	RMM busy
	5	20	Reserved for future Chapter 10 status bit
	6	40	Reserved for future Chapter 10 status bit
	7	80	Reserved for future Chapter 10 status bit
	8-31		Vendor-specific health status bits

6.5.2 Date and Time Setting Requirements

To set time, the .TIME commands should be used according to Subsection [6.2.3.10](#).

6.5.2.1 Time Setting Using IEEE 1394b

To guarantee avoiding uncontrolled delay, the following algorithm shall be used.

- a. The host device puts a .TIME command with time parameter to be set in its SEND buffer and sends it at least 100 ms prior to the correct time to the real-time clock device. The delay is necessary to allow the processor device to be prepared for the exact time setting and to hold off enough in the host to force a doorbell with the next SCSI command. Without enough delay the host will not be able to chain the next SCSI command together with the previous command. If the operating system demands it a delay greater than 100 ms can be used.

- b. The processor device shall process this time and be prepared to set it at receipt of the doorbell.
- c. A .SEND command shall be sent to the real-time clock with the message .TIME without parameters to query for the time as set.

6.5.2.2 Time Setting using Ethernet

To minimize inaccuracy, the IEEE 1588 PTP may be used. How an RMM derives time from PTP is not controlled by the standard. The .TIME PTP and .TIME PTPSTATUS variants of the .TIME command shall be used to enable and view the status of the PTP implementation.

6.5.2.3 Date Setting Requirements

A .DATE [start-date] command shall be utilized for setting or displaying date of the removable memory real-time clock. The date shall be set in year-month-day format according to ISO Standard 8601:2004.

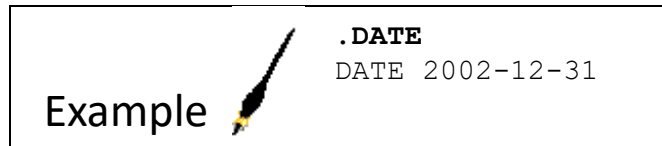

6.5.3 Declassification Supporting Commands

6.5.3.1 .IDENTIFY

A .IDENTIFY command queries the RMM for solid-state disk (SSD) identification and firmware version.

- Description

This command queries the RMM for SSD identification information and firmware version.

- Parameters

None

- Response

The RMM responds with one line containing five comma-separated fields. Characters and spaces are allowed within the comma-separated fields. Response time shall be within 100 ms. A .STATUS command request prior to 100 ms shall elicit a BUSY response.

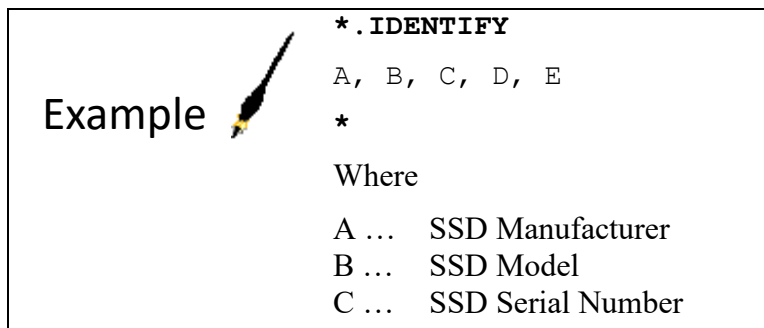

D ...	RMM Firmware Version
E ...	SSD Firmware Version

6.5.3.2 .MEDIA P

The .MEDIA P command is utilized to query the RMM for information regarding the physical block architecture of the SSD and the SCSI RECEIVE transfer limits in effect when reading physical blocks.

- Parameters

The parameter “P” distinguishes this command from the standard .MEDIA command.

- Response

The RMM responds with one line containing the tag “PHYSICAL” and five space-separated integer numbers. Response time shall be within 100 ms. A .STATUS command prior to 100 ms shall return a BUSY state.

Example

* .MEDIA P

PHYSICAL A B C D E

*

A = Physical block size in bytes. This value must be a multiple of item D below.

B = Total number of physical blocks in SSD.

C = Maximum operation request block (ORB) transfer size that can be used when reading the binary data from the physical block with the .BBREAD D and .PBWRITE D commands.

D = Number of valid data bytes in a physical page. Item A above must be an integer multiple of this value.

E = This field specifies the number of filler bytes appended onto each physical page read from the RMM. Filler bytes are typically inserted to pad the transfer to the next Advanced Technology Attachment sector boundary. If no padding is required, this field may be 0.

6.5.3.3 .SANITIZE

A .SANITIZE command shall initiate a write/verify of all RMM user data physical blocks. The pattern may consist of either all FFs or all 00s. The .SANITIZE command shall identify any blocks that cannot be written or verified. Blocks that cannot be written to or contain at least one bit that is stuck in either the 0 or the 1 state are termed bad blocks. The user shall review the block contents and map out the bad blocks such that they are no longer addressable. Once the address has been mapped out the blocks are no longer addressable and are no longer identified in the bad block table ([Figure 6-11](#)).

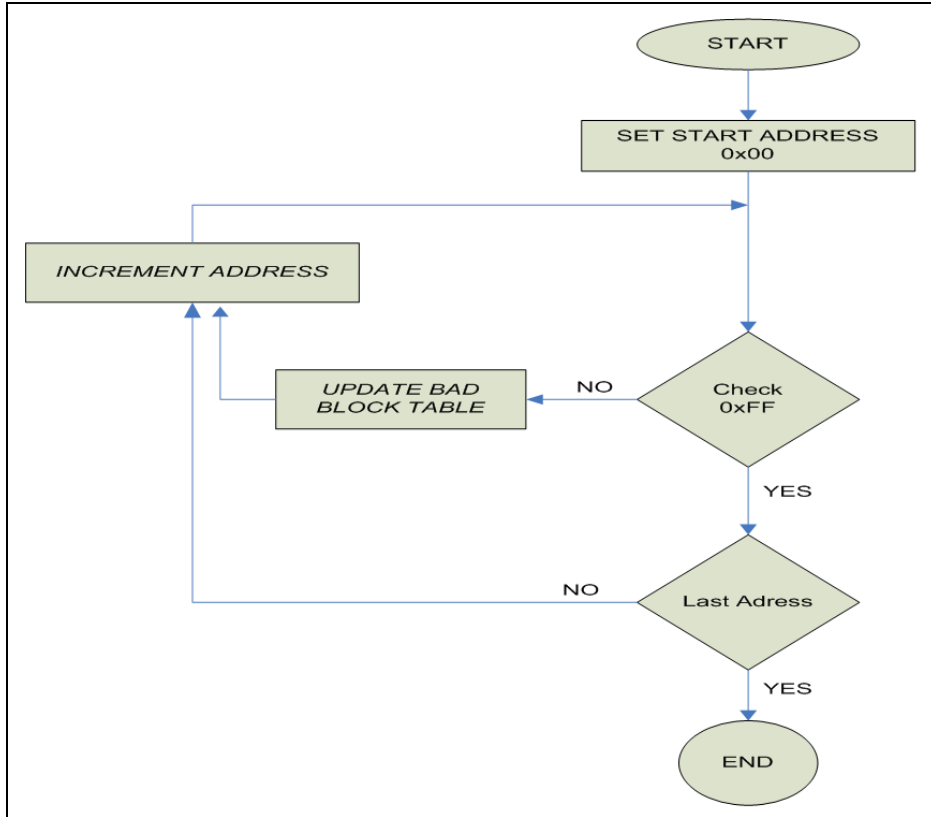

Figure 6-11. Updating the Bad Block Table

- Parameters

None

- Response

The RMM responds with an asterisk. Response time shall be within 100 ms. A .STATUS command prior to 100 ms shall elicit a BUSY response. During sanitization the RMM shall respond with “S 04 xx yy zz”; where zz indicates percentage complete. Upon completion a status response of “S 11 xx yy” shall indicate that bad blocks were found. A status response upon completion of “S 12 xx yy” shall indicate that no bad blocks were found.

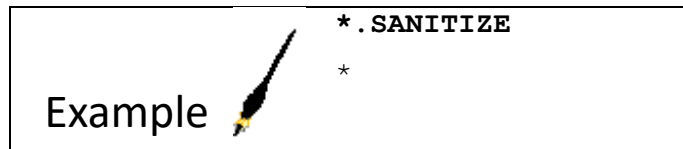

6.5.3.4 .BBLIST

A .BBLIST command shall be utilized to instruct the RMM to retrieve the list of unsecured bad block identifiers from solid-state media residing in the RMM. A .BBLIST command is only valid following a .SANITIZE command.

- Parameters

None

- Response

The RMM responds with an asterisk. Response time shall be within 100 ms. A .STATUS command prior to 100 ms shall return a BUSY state.

<p>Example </p>	*.BBLIST
	*

6.5.3.5 .BBLIST R

A .BBLIST R command shall be used to retrieve bad block identifiers from the RMM. This command may only be issued immediately following a successful .BBLIST command.

- Parameters

The parameter “R” distinguishes this command from the standard .BBLIST command.

- Response

The RMM must respond with a list of hexadecimal bad block identifiers. Each identifier must be terminated with a <CR><LF> sequence. Each identifier must be a legal hexadecimal number from 1 to 16 digits. No embedded spaces or other special characters are allowed. Response time shall be within 100 ms. A .STATUS command prior to 100 ms shall return a BUSY state.

<p>Example </p>	*.BBLIST R
	000000E3
	0000034F
	FE0184C9
	*

6.5.3.6 BBREAD P {block_identifier}

A .BBREAD P {block_identifier} command shall direct the RMM to initiate a physical block read of the specified physical block identifier.

- Parameters

The parameter “P” distinguishes this as a binary physical block read command.

The parameter block_identifier is the physical block identifier from the BBLIST R response of the block to be read.

- Response

The RMM responds with an asterisk. Response time shall be within 100 ms. A .STATUS command prior to 100 ms shall return a BUSY state.

<p>Example </p>	.BBREAD P FE0184C9
	*

6.5.3.7 .BBREAD D

A .BBREAD D command shall read one binary physical block from the RMM. This command may only be issued immediately after a successful .BBREAD P command. The physical block size, page size, page filler size, and maximum SCSI receive transfer size that are required to perform the transfer are all specified in the RMM's response to the .MEDIA P command.

- Parameters

None.

- Response

The RMM responds by returning the requested binary physical block data. Multiple SCSI receive commands may be required to retrieve the entire physical data block.

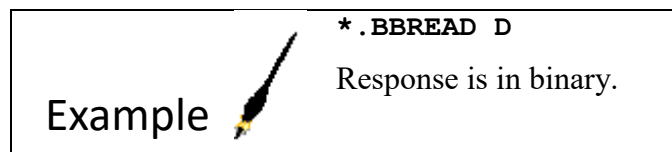

6.5.3.8 .BBSECURE {block identifier}

A .BBSECURE command shall be utilized to mark an unsecured bad block as being secured. A block that has been identified as secured shall never be used for any subsequent data recording. Secured bad blocks shall be removed from the unsecured bad block identifier list. The block identifier shall be provided for the block to be secured.

- Parameters

The parameter block_identifier is the physical block identifier from the .BBLIST R response of the block to be secured.

- Response

The RMM responds with an asterisk.

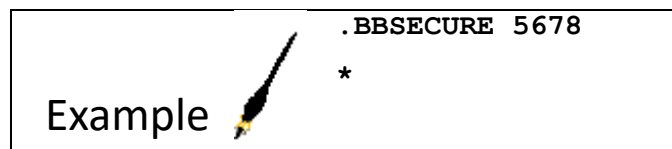

6.5.3.9 .PBWRITE P {block_identifier}

A .PBWRITE P {block_identifier} command shall direct the RMM to initiate a physical block write of the specified physical block identifier.

- Parameters

The parameter block_identifier is the physical block identifier from the BBLIST R response of the block to be written.

- Response

The RMM responds with an asterisk. Response time shall be within 100 ms. A .STATUS command prior to 100 ms shall return a BUSY state.

<p>Example </p>	<pre>.PBWRITE P FE0184C9</pre>
	<pre>*</pre>

6.5.3.10 .PBWRITE D

A .PBWRITE D command shall write one binary physical block to the RMM. This command may only be issued immediately after a successful .PBWRITE P command. The size of the physical block transfer size and the maximum SCSI send page size required to perform the transfer are all specified in the RMM’s response to the .MEDIA P command.

- Parameters

Binary data block. Multiple SCSI send commands may be required to transfer the entire physical data block.

- Response

The RMM responds with an asterisk after all data is successfully received.

<p>Example </p>	<pre>*.PBWRITE D</pre>
	<pre><binary data> total length = physical block size.</pre>

6.5.3.11 .INITIALIZE

A .INITIALIZE command shall be utilized to configure the RMM memory and reset of the firmware.

- Parameters

None

- Response

The RMM responds with an asterisk. Response time shall be within 100 ms. A .STATUS command prior to 100 ms shall return a BUSY state. A response of “S13 xx yy zz”; where zz indicates percentage complete shall be provided. Upon completion, a response of “S 14 xx yy” shall be provided; where yy indicates number of seconds required after initialization.

<p>Example </p>	<pre>*.INITIALIZE</pre>
	<pre>*</pre>
	<pre>.STATUS</pre>
	<pre>S 13 00 00 01%</pre>
	<pre>.STATUS</pre>
	<pre>S 13 00 00 02%</pre>
	<pre>•</pre>
	<pre>•</pre>

```

•
. STATUS
S 13 00 00 100%
. STATUS
S 14 00 03
. STATUS
S 01 00 00
    
```

6.5.3.12 .DECLASSIFY

A .DECLASSIFY command shall be utilized to initiate user procedures.

- Parameters

None

- Response

The RMM responds with an asterisk. Response time shall be within 100 ms. A .STATUS command prior to 100 ms shall return a BUSY state. During sanitization the RMM shall respond with “S 04 xx yy zz”; where zz indicates percentage complete. Upon completion a status response of “S 11 xx yy” shall indicate that bad blocks were found. A status response upon completion of “S 12 xx yy” shall indicate that no bad blocks were found.

```

Example  * .DECLASSIFY
*
    
```

6.5.3.13 .IRIG106

A .IRIG106 command shall be utilized to retrieve the RCC 106-supported version number.

- Parameters

None

- Response

The RMM responds with a version number that shall be a two-integer value representing the last two digits of the year of RCC 106 release supported by the device. Response time shall be within 100 ms. A .STATUS command prior to 100 ms shall return a BUSY state.

```

Example  * .IRIG106
09
*
    
```

6.5.3.14 .STATUS

A .STATUS command shall be utilized to query the RMM for status information (see [Table 6-15](#)).

- Description
This command queries the RMM for status information.
- Parameters
None
- Response

The RMM response to a .STATUS command is of the form:

Example	<pre>* .STATUS S A B C [D%] *</pre>
----------------	---

Table 6-15. Removable Memory Module States				
State	Description			
	State Code (A)	State Value (B)	State Value (C)	Progress Percentage (D)
FAIL	00			
IDLE	01	00	00	
BIT	02	00	00	Percent Complete
ERASE	03	00	00	Percent Complete
DECLASSIFY SANITIZE	04	00	00	Percent Complete
BUSY	09	00	00	
SANITIZE COMPLETED BAD BLOCKS FOUND	11	00	Number of bad blocks found (Integer)	
SANITIZE COMPLETED NO BAD BLOCKS FOUND	12	00	00	
INITIALIZE IN PROGRESS	13	00	00	Percent Complete
INITIALIZE COMPLETE	14	00	Number of seconds required for initialization (Integer)	

6.5.3.15 RMM Command Error Codes

Issuing invalid commands (bad syntax) or illegal commands (not accepted in the current system state) results in error code responses (with an ASCII “E” identifier) prior to the asterisk response terminator when a command cannot be completed. [Table 6-16](#) shows possible error codes and the conditions under which they occur.

Table 6-16. Command Error Codes		
Error	Description	Condition*s
00	INVALID COMMAND	Command does not exist
01	INVALID PARAMETER	Parameter is out of range, or wrong alpha-numeric type
02	INVALID MODE	Command cannot be executed in the current state
05	COMMAND FAILED	Command failed to execute for any reason other than those listed above



6.5.4 SCSI and iSCSI Commands.

The mandatory SCSI command set for vendor-specific devices is as follows. Note that the SCSI standard imposes additional requirements for a device to be compliant.

- a. For random-access devices:

INQUIRY
 READ
 READ CAPACITY
 REQUEST SENSE
 TEST UNIT READY

- b. For sequential-access devices:

INQUIRY
 READ
 REWIND
 TEST UNIT READY
 REQUEST SENSE

6.5.5 Mandatory ORB Formats for the Processor Device Using IEEE 1394b

6.5.5.1 Minimum Operational Requirements

The time setting accuracy of the real-time clock device should be better than 1 ms. The short time accuracy of the real-time clock device must be better than 10 parts per million (ppm) in the temperature range 0-40°C and better than 50 ppm in the temperature range -40°C - +85°C.

6.5.5.2 IEEE 1394b ORB Format.

- a. Login ORB format. The login ORB format is illustrated in [Figure 6-12](#).

Most significant bit (msb)										Least significant bit (lsb)	
31	30	29	28	27	24	23	20	19	16	15	0
Password											
Login_response											
n	Rq_fmt		x	Reserved			Reconnect		Function		LUN
password_length										login_response_length	
Status_FIFO											

Figure 6-12. Login ORB Format

- Password. In this 32-bit field, the password shall be “RTC.” The password field shall contain the immediate data and the password_length shall be zero.
 - Login_response. 32 bits.
 - login_response_length. 16 bits.
 - The Login_response field and login_response_length fields shall specify the address and size of a buffer (minimum of 12 bytes) allocated by the host for the return of the login response.
 - n. In this one-bit field, the notify bit “n” shall be one.
 - Rq_fmt. In this two-bit field, the rq_fmt shall be zero.
 - x. In this one-bit field, the exclusive bit “x” shall be one.
 - Reserved. A four-bit field, Reserved shall be zero.
 - Reconnect. The four-bit reconnect field shall specify the reconnect time as a power of 2 seconds. A value of zero shall mean one second.
 - Function. This field is four bits. The function shall be zero.
 - LUN. This is 16 bits. The LUN shall be one.
 - Status_FIFO. The 64-bit Status_FIFO shall contain the address allocated by the host for the return of status for the login request and for the return of subsequent write and read buffer response(s) indicating success/failure of the operation.
- b. Login Response. The login response format is illustrated in [Figure 6-13](#).

msb										lsb			
31											16	15	0
Length										login_ID			
command_block_agent													
reserved										reconnect_hold			

Figure 6-13. Login Response Format

- Length. This 16-bit field contains the length, in bytes, of the login response data.
- login_ID. This 16-bit field is used in all subsequent requests to the SCSI multimedia command’s management agent.

- command_block_agent. This is a 64-bit field that contains the base address of the agent’s control and status register.
 - Reserved. This 16-bit field shall be zero.
 - Reconnect_hold. This 16-bit field is to be defined.
- c. Send. The send command ORB format is illustrated in [Figure 6-14](#), and the send data buffer format is illustrated in [Figure 6-15](#). The send data buffer contains the send command with the carriage return, line feed, and binary 0 character terminated. Alternatively, a .PBWRITE D command will send data in binary format.

msb															lsb		
31	30	29	28	27	26	24	23	21	20	19	18	17	16	15	8	7	0
next_ORB																	
data_descriptor																	
n	Rq_fmt		r	d	Spd			max_payload		p	page_size			data_size			
0Ah							LUN		Res			AEN		Xfer Lng - upper bits			
Xfer Lng - lower bits							Control						00h		00h		
00h							00h						00h		00h		

Figure 6-14. Send Command ORB Format

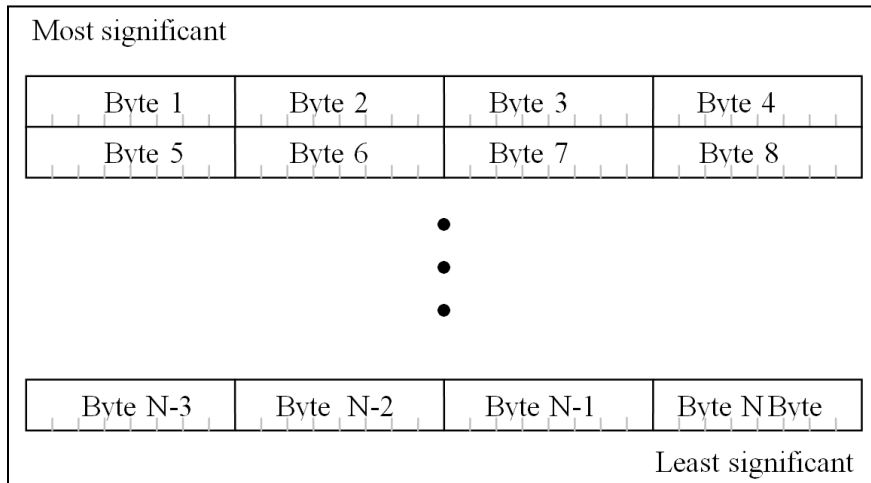

Figure 6-15. Send Data Buffer Format

- next_ORB. This 64-bit field contains the ORB pointer format, which shall be IAW SBP-2 specifications.
- data_descriptor. The 32-bit data_descriptor field shall contain the address of the data buffer.
- n. The completion notification “n” in this one-bit field shall be one. The target shall store a status block at the Status_FIFO address at the address supplied in the login request.
- Rq_fmt. Required format in this two-bit field shall be zero.
- r. Reserved in this one-bit field shall be zero.

- d. Direction bit in this one-bit field shall be zero.
- spd. This is a three-bit field that contains speed, which shall have a value of two.
- max_payload. A four-bit field, the maximum data transfer length shall be nine.
- p. This is a one-bit field. The RMM must be prepared to handle the page table bit p=0 and p=1 cases, as the standard operating systems set this bit without influence of the application process.
- page_size. This is three bits. Page size shall be zero if the p field is set to 0; otherwise this field shall be set to the valid page size.
- data_size. This is 16 bits. The data size field should be set according to the allocated send buffer size in bytes (N). The length must be at least 80 (0x50).
- LUN. The LUN shall be one in this three-bit field.
- Res. This is a four-bit field. Reserved shall be zero.
- AEN. In this one-bit field, AEN shall be zero.
- Xfer Lng. This is 24 bits. The length must be at least 80 (0x50).
- Control. In this 8-bit field, control shall be 128.

d. Receive. The receive command block ORB format is illustrated in [Figure 6-16](#).

msb																						lsb
31	30	29	28	27	26	24	23	21	20	19	18	17	16	15	8	7	0					
next_ORB																						
data_descriptor																						
n		Rq_fmt		r	d	spd			max_payload			p	page_size			data_size						
0Ah						LUN			Res			AEN	Xfer Lng - upper bits									
Xfer Lng - lower bits						Control						00h		00h								
00h						00h						00h		00h								

Figure 6-16. Receive Command Block ORB Format

- next_ORB. This 64-bit field contains the ORB pointer format, which shall be IAW SBP-2 specifications.
- data_descriptor. The 32-bit data_descriptor field shall contain the address of the data buffer.
- n. The completion notification “n” in this one-bit field shall be one. The target shall store a status block in the Status_FIFO field at the address supplied in the login request.
- Rq_fmt. Required format in this two-bit field shall be zero.
- r. Reserved in this one-bit field shall be zero.
- d. Direction bit in this one-bit field shall be zero.
- spd. This is a three-bit field that contains speed, which shall have a value of two.

- max_payload. A four-bit field, the maximum data transfer length shall be nine.
- p. This is a one-bit field. The RMM must be prepared to handle the page table bit $p=0$ and $p=1$ cases, as the standard operating systems set this bit without influence of the application process.
- page_size. This is three bits. Page size shall be zero if the p field is set to 0; otherwise this field shall be set to the valid page size.
- data_size. This is 16 bits. The data size field should be set according to the allocated send buffer size in bytes (N). The length must be at least 80 (0x50).
- LUN. The LUN shall be one in this three-bit field.
- Res. This is a four-bit field. Reserved shall be zero.
- AEN. In this one-bit field, AEN shall be zero.
- Allocation_Lng. This is 24 bits. $\text{Allocation_Lng} = \text{length of the Chapter 6 response string}$.
- Control. In this 8-bit field, control shall be 128.

The receive data buffer can be returned in ASCII format (see [Figure 6-17](#)) or in binary format (see [Figure 6-18](#)) if the retrieved data contains binary information. Multiple ORBs may be used to retrieve the data required.

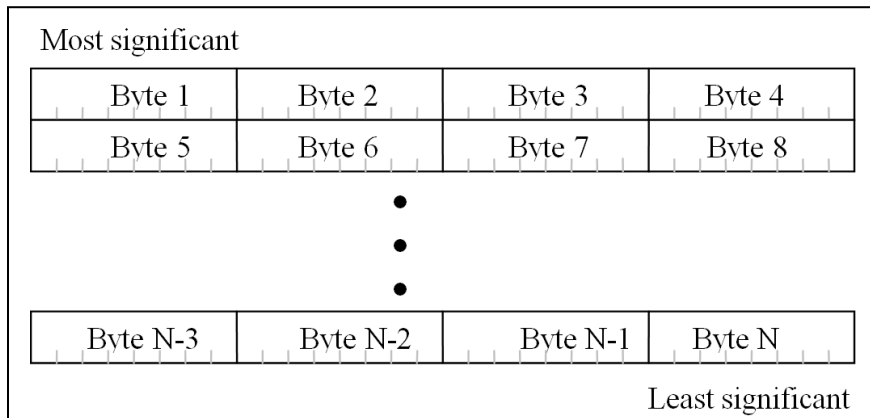

Figure 6-17. Receive Data Buffer Format ASCII Format

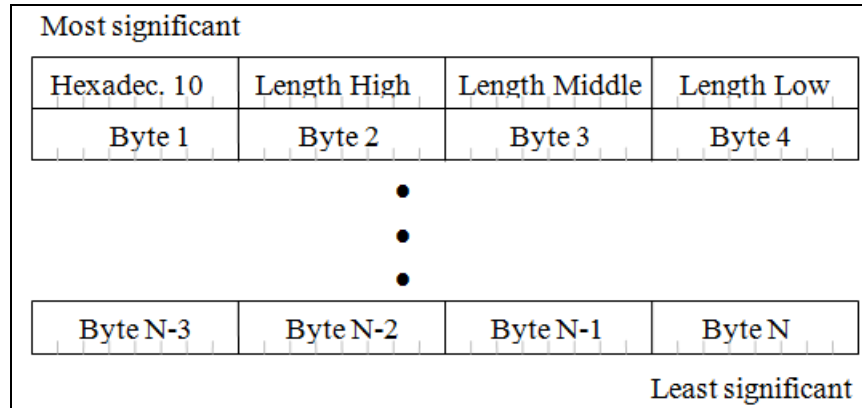

Figure 6-18. Receive Data Buffer Binary Format

- The returned remote answer is an ASCII text terminated by the “*” character IAW Section 6.2. If the “*” terminator is missing, multiple receive commands must be used to retrieve the data until the “*” terminator is received.
- The returned remote answer can contain mixed ASCII text or binary information until the specified length in the first 32-bit word. The first byte is a hexadecimal 10 code to identify the binary format (codes hexadecimal 11-1F are reserved for future extensions). The answer must be terminated by the “*” character IAW Subsection 6.2.1. If the “*” terminator is missing, multiple receive commands must be used to retrieve the data until the “*” terminator is received.

6.5.6 Additional Mandatory Commands When Using Ethernet

6.5.6.1 .MEDIA E

The .MEDIA E command is utilized to query the RMM for information regarding which of the data access protocols is supported.

- Parameters
The parameter “E” distinguishes this command from the standard .MEDIA command.
- Response
The RMM responds with one line containing the tag “PROTOCOLS” and at least one of the tags “FTP”, “ISCSI”, and “PTP” in alphabetical order each separated by a space. Response time shall be within 100 ms. A .STATUS command prior to 100 ms may return a BUSY state.
- Example
*.MEDIA E
PROTOCOLS FTP PTP
*

6.5.6.2 .RMMIP

The .RMMIP command shall be utilized to display RMM IP address and addressing mode.

- Parameters
None
- Response
The RMM responds with one line containing the tag “IP_ADDRESS”, either the tag “STATIC” or “DHCP”, and three space-separated “dotted quad” IPv4 addresses, representing the IP address of the RMM, the net mask associated with that address, and the default gateway for the network associated with the net mask. If Dynamic Host Control Protocol (DHCP) is being used and no DHCP address has been obtained, all three address fields shall be set to 0.0.0.0. Response time shall be within 100 ms. A .STATUS command prior to 100 ms may return a BUSY state.
- Examples
*.RMMIP
IP_ADDRESS STATIC 10.6.9.2 255.0.0.0 10.6.9.1
*.RMMIP
IP_ADDRESS DHCP 192.168.2.1 255.255.255.0 192.168.2.254
*.RMMIP
IP_ADDRESS DHCP 0.0.0.0 0.0.0.0 0.0.0.0
*

6.5.6.3 .RMMIP keyword [parameters]

The .RMMIP command shall be utilized to control RMM IP address and addressing mode.

- Keywords
DHCP - used to set the RMM to DHCP mode.
RESET - used to reset the Ethernet RMM to defaults, including IP addresses, frame size, and login passwords.
xxx.xxx.xxx.xxx - used to set the RMM to static mode with the indicated IPv4 address; requires parameters. “xxx” indicates any number between 0 and 255.
- Parameters
NetMask Gateway- used to specify the net mask for the static IP address and the default gateway for the network associated with the net mask. Each has the form xxx.xxx.xxx.xxx
- Response
The RMM responds with an asterisk. Response time shall be within 100 ms. A .STATUS command prior to 100 ms may return a BUSY state.
- Examples
.RMMIP DHCP

*

.RMMIP RESET

*

.RMMIP 192.168.10.99 255.255.255.0 192.169.10.254

*

6.5.6.4 .TIME PTP

A .TIME PTP command shall be used to initiate the process of synchronizing the RMM real-time clock with an IEEE-1588 network time source. Note that successful synchronization with a time source will implicitly set the date as well as the time.

- Parameters

The parameter “PTP” distinguishes this command from the standard .TIME command.

- Response

The RMM responds with an asterisk. Response time shall be within 100 ms. A .STATUS command prior to 100 ms may return a BUSY state.

6.5.6.5 .TIME PTPSTATUS

A .TIME PTPSTATUS command shall be used to report the state of synchronization between the RMM real-time clock and an IEEE-1588 network time source.

- Parameters

The parameter “PTPSTATUS” distinguishes this command from the standard .TIME command.

- Response

The RMM responds with one line containing one of the words “LOCKED” or “NONE”, followed by an asterisk on a new line. “NONE” indicates that no sync has been obtained; “LOCKED” indicates that the RMM’s clock has been synchronized with a network clock. Response time shall be within 100 ms. A .STATUS command prior to 100 ms may return a BUSY state.

6.5.6.6 .TMATS GET

A .TMATS GET command shall be used to transfer the contents of the RSCF on the RMM media into a volatile buffer. No additional parameter is required, and if one is specified it shall be ignored.

- Parameters

The parameter “GET” distinguishes this command from other .TMATS commands.

- Response

The RMM responds with an asterisk. If no valid RSCF IAW [Chapter 10](#) Subsection 10.3.8.1 is located on the RMM media, an error is returned and the volatile buffer is erased. A .STATUS command prior to 100 ms may return a BUSY state.

6.5.6.7 .TMATS READ

A .TMATS READ command shall be used to display the contents of the volatile buffer created by either a .TMATS GET or a .TMATS WRITE command for the RSCF.

- Parameters
The parameter “READ” distinguishes this command from other .TMATS commands.
- Response
The RMM responds by displaying the contents of the volatile buffer followed by a line containing an asterisk. If the buffer contains no RSCF, no error shall be returned.

6.5.6.8 .TMATS SAVE n

A .TMATS SAVE command shall be used to transfer the contents of the volatile buffer created by a .TMATS WRITE command to the media. If the media already contains any data (except for a previous RSCF), an error shall be returned. The created file shall be IAW [Chapter 10](#) Subsection 10.3.8.1.

- Parameters
The parameter “SAVE” distinguishes this command from other .TMATS commands. The number following is used to generate the file name of the RSCF, “recorder_configuration_file_SAVE_n”.
- Response
The RMM responds with an asterisk. A .STATUS command prior to 100 ms may return a BUSY state.

6.5.6.9 .TMATS WRITE

A .TMATS WRITE command shall be used to transfer a TMATS file to the RMM for subsequent use as an RSCF.

- Parameters
The parameter “WRITE” distinguishes this command from other .TMATS commands.
- Response
The RMM responds by entering TMATS data transfer mode. All data sent to the RMM will be added to a volatile buffer until a line with the single word “END” is received, following which the RMM responds with an asterisk.

6.5.7 Additional Non-Mandatory Commands When Using Ethernet.

6.5.7.1 .RMMFRAME

The .RMMFRAME command shall be utilized to display the current and maximum values for the Ethernet frame size or maximum transmission unit (MTU).

- Parameters
None

- Response

The RMM responds with one line containing two integers separated by a “/”. The first integer indicates the currently configured frame size (default: 1500 bytes), and the second is the largest frame size supported by the RMM.

- Example

*.RMMFRAME

1500/9200

*.RMMFRAME

1500/1500

*.RMMFRAME

1300/9000

 NOTE	An RMM command error code of 00 (“Invalid Command”) shall be interpreted to mean that the default value of 1500 bytes only is supported, and thus is synonymous with a response of “1500/1500”.
---	---

6.5.7.2 .TCPPOPTS ffff

A .TCPPOPTS command with a parameter of an integer shall be used to configure the Ethernet frame size or MTU to be used.

- Parameters

ffff where ffff is the value to be used.

- Response

The RMM responds with an asterisk. A .STATUS command prior to 100 ms may return a BUSY state.

Once the RMM has responded, all devices connecting to the RMM shall adjust their own frame size settings to match the new setting.

- Example

*.RMMFRAME 9000

*

6.5.7.3 .TCPPOPTS

The .TCPPOPTS command shall be utilized to display the port numbers used for the network services (Telnet, FTP, iSCSI).

- Parameters

None

- Response

The RMM responds with one line containing three comma-separated integers between 0 and 65535. The first integer indicates the port at which the Telnet server is listening, the next is the port used by the FTP server, and the third is for iSCSI. If an RMM does not support one of the two data access methods, it may report “0”.

- Example

*.TCPPOPTS

923,921,3260

*.TCPPOPTS

923,0,3260

*.TCPPOPTS

928,921, 0

 <p>NOTE</p>	<p>Note: a response of “0,0,0” or an RMM command error code of 00 (“Invalid Command”) shall be interpreted to mean that the default ports are being used, and thus is synonymous with a response of “923,921,3260”.</p>
--	---

6.5.7.4 .TCPPOPTS ppp,qqq,rrr

A .TCPPOPTS command with a parameter of three comma-separated integers between 0 and 65535 shall be used to configure TCP ports used by each of the three services defined for Ethernet RMM devices.

- Parameters

ppp,qqq,rrr where ppp is the port to be used for the Telnet service, qqq is the port to be used for the FTP service, and rrr is the port to be used for iSCSI. A value of “0” in any one of the positions indicates that the current port configuration for that service is not to be changed.

- Response

The RMM responds with an asterisk. A .STATUS command prior to 100 ms may return a BUSY state.

If the port for the Telnet service is changed, the RMM may unilaterally disconnect (close the Telnet TCP connection) following the asterisk. The currently configured Telnet port shall be accessible by means of the Service Location Protocol IAW [Chapter 10](#) Subsection 10.9.3.2 item c.

- Example

*.TCPPOPTS 923,921,3260

*

This page intentionally left blank.

APPENDIX 6-A

MIL-STD-1553 Remote Terminal Command and Control

The MIL-STD-1553 implementation of Chapter 6 commands complies with typical bus controller (BC) operation. Typically, C&C receive messages are aperiodic and are only issued when specific R/R action is required by the BC. The C&C transmit messages are periodic and report status back to the BC.

A.1. Receive Messages

[Table A-1](#) provides a description of the MIL-STD-1553 receive commands defined in the following sections.

Table A-1. Military Standard 1553 Receive (Bus Controller to Remote Terminal) Command Set		
Command	Subaddress	Description
ASSIGN	1	Selects the input channel to be replayed
BIT	1	Runs all of the built-in tests
ERASE	1	Erases the recording media
EVENT	1	Marks an event
INFO	1	Requests detailed information regarding a specific file or event (see INFO Transmit Command in Table A-2)
PAUSE	1	Pauses recording of all or specific channels
REPLAY	1	Controls the replay of recorded data
PUBLISH	1	Configures/controls Ethernet interface
QUEUE	1	Sets the replay point in the recorded data to a file or event
RECORD	1	Starts a recording at the current end of data
RESET	1	Performs software-initiated system reset
RESUME	1	Resumes recording of paused channels
SANITIZE	1	Secure-erases the recording media
STOP	1	Stops the current recording, playback, or both
TIME	1	Sets the internal system time

A.1.a. Receive Message Length

All R1 (subaddress 1) command (receive) messages have 32 data words. All unused data words are zero-filled. If the R/R receives an improperly formed BC to remote terminal (RT) message (length error, parity error, etc.) it will respond with an error status word (the last word of a BC-to-RT transaction) and the message will be ignored by the R/R control program. The acceptability of any properly formed BC-to-RT message received by the R/R is determined by the content of the message and the state of the R/R when the message is received, as identified in this standard. The R2 (subaddress 2) command (receive) message has 1 data word.

WORD NAME: Output Channel Number

WORD ID:	R1-001-02	RANGE:	N/A
SOURCE:	BC	ACCURACY:	N/A
DESTINATION:	R/R	lsb:	N/A
XMIT RATE	Aperiodic		
SIGNAL TYPE	Discrete		
UNITS	N/A		

BIT NO.	DESCRIPTION
0	msb -----
1	Hex Digit #1
2	
3	lsb -----
4	msb -----
5	Hex Digit #2
6	
7	lsb -----
8	msb -----
9	Hex Digit #3
10	
11	lsb -----
12	msb -----
13	Hex Digit #4
14	
15	lsb -----

WORD NAME: Input Channel Number

WORD ID:	R1-001-03	RANGE:	N/A
SOURCE:	BC	ACCURACY:	N/A
DESTINATION:	R/R	lsb:	N/A
XMIT RATE	Aperiodic		
SIGNAL TYPE	Discrete		
UNITS	N/A		

BIT NO.	DESCRIPTION
0	msb -----
1	Hex Digit #1
2	
3	lsb -----
4	msb -----
5	Hex Digit #2

```

6
7   lsb   -----
8   msb   -----
9         Hex Digit #3
10
11  lsb   -----
12  msb   -----
13         Hex Digit #4
14
15  lsb   -----
    
```

A.1.c. BIT Command

The BIT command is used to start an initiated built-in test (IBIT). While in the BIT state, the percent complete is output via the STATUS transmit command. When the IBIT completes, the state of the R/R as returned by the STATUS transmit command indicates either “IBIT Pass” (state = IDLE) or “IBIT Fail” (state = FAIL). Additional failure details may be obtained from the HEALTH transmit command response. An IBIT requires no more than 10 seconds to complete.

MESSAGE NAME: BIT

MESSAGE ID: R1-002 TRANSFER TYPE: BC-RT
 SOURCE: BC WORD COUNT: 32
 DESTINATION: R/R

WORD NAME	WORD NO.	DESCRIPTION
Command Word	CW	Subaddress 00001 binary
BIT Command ID	01	ID of Assign command = 0x0002
Zero	2-32	Zero-filled
Status Word	SW	MIL-STD-1553 Status Word

WORD NAME: BIT Command ID

WORD ID: R1-002-01 RANGE: N/A
 SOURCE: BC ACCURACY: N/A
 DESTINATION: R/R lsb: N/A
 XMIT RATE Aperiodic
 SIGNAL TYPE Discrete
 UNITS N/A

```

BIT NO.                    DESCRIPTION
0   msb   -----
1         Hex Digit #1 = 0
    
```

```

2
3   lsb   -----
4   msb   -----
5         Hex Digit #2 = 0
6
7   lsb   -----
8   msb   -----
9         Hex Digit #3 = 0
10
11  lsb   -----
12  msb   -----
13        Hex Digit #4 = 2
14
15  lsb   -----
    
```

A.1.d. Erase Command

The Erase command is used to erase internal recording drive or RMM installed in the R/R. While in the Erase state, the percent complete is output via the STATUS transmit command.

MESSAGE NAME: Erase

MESSAGE ID: R1-004 TRANSFER TYPE: BC-RT
 SOURCE: BC WORD COUNT: 32
 DESTINATION: R/R

WORD NAME	WORD NO.	DESCRIPTION
Command Word	CW	Subaddress 00001 binary
Erase Command ID	01	ID of Erase command = 0x0004
Zero	2-32	Zero-filled
Status Word	SW	MIL-STD-1553 Status Word

WORD NAME: Erase Command ID

WORD ID: R1-004-01 RANGE: N/A
 SOURCE: BC ACCURACY: N/A
 DESTINATION: R/R lsb: N/A
 XMIT RATE Aperiodic
 SIGNAL TYPE Discrete
 UNITS N/A

```

BIT NO.                    DESCRIPTION
0   msb   -----
1         Hex Digit #1 = 0
    
```

```

2
3   lsb      -----
4   msb      -----
5           Hex Digit #2 = 0
6
7   lsb      -----
8   msb      -----
9           Hex Digit #3 = 0
10
11  lsb      -----
12  msb      -----
13           Hex Digit #4 = 4
14
15  lsb      -----
    
```

A.1.e. Event Command

The Event command is used to mark a specific event occurrence with the insertion of a Chapter 10 event packet in the recording file. The BC programmer can define up to 31 events numbered 1 to 31 in the TMATS packet that is loaded into the recorder from the RMM and written as the first packet in each data file.

MESSAGE NAME: Event

MESSAGE ID: R1-005 TRANSFER TYPE: BC-RT
 SOURCE: BC WORD COUNT: 32
 DESTINATION: R/R

WORD NAME	WORD NO.	DESCRIPTION
Command Word	CW	Subaddress 00001 binary
Event Command ID	01	ID of Event command = 0x0005
Event Number	02	1-origin number of a defined event
Zero	3-32	Zero-filled
Status Word	SW	MIL-STD-1553 Status Word

WORD NAME: Event Command ID

WORD ID: R1-005-01 RANGE: N/A
 SOURCE: BC ACCURACY: N/A
 DESTINATION: R/R lsb: N/A
 XMIT RATE Aperiodic
 SIGNAL TYPE Discrete
 UNITS N/A

BIT NO. DESCRIPTION

0	msb	-----
1		Hex Digit #1 = 0
2		
3	lsb	-----
4	msb	-----
5		Hex Digit #2 = 0
6		
7	lsb	-----
8	msb	-----
9		Hex Digit #3 = 0
10		
11	lsb	-----
12	msb	-----
13		Hex Digit #4 = 5
14		
15	lsb	-----

WORD NAME	Event Number		
WORD ID:	R1-005-02	RANGE:	N/A
SOURCE:	BC	ACCURACY:	N/A
DESTINATION:	R/R	lsb:	N/A
XMIT RATE	Aperiodic		
SIGNAL TYPE	Discrete		
UNITS	N/A		

BIT NO.	DESCRIPTION	
0	msb	-----
1		Hex Digit #1 = 0
2		
3	lsb	-----
4	msb	-----
5		Hex Digit #2 = 0
6		
7	lsb	-----
8		Binary 0
9		Binary 0
10		Binary 0
11	msb	-----
12		
13		5-bit binary event number from 1 to N where N is the number of defined
14		BC events in the R/R setup record.
15	lsb	-----

A.1.f. Info (receive) Command

The Info receive command is used to specify the desired information to be returned to the BC from the R/R by the Info transmit command (see Paragraph [A.2.d](#)).

MESSAGE NAME: Info (receive)

MESSAGE ID: R1-007 TRANSFER TYPE: BC-RT
 SOURCE: BC WORD COUNT: 32
 DESTINATION: R/R

WORD NAME	WORD NO.	DESCRIPTION
Command Word	CW	Subaddress 00001 binary
Info Command ID	01	ID of Info (receive) command = 0x0007
Info Type and Number	02	Info type and file or event number
Info Event Occurrence	03	Specific occurrence when type = event
Zero	4-32	Zero-filled
Status Word	SW	MIL-STD-1553 Status Word

WORD NAME: Info Command ID

WORD ID: R1-007-01 RANGE: N/A
 SOURCE: BC ACCURACY: N/A
 DESTINATION: R/R lsb: N/A
 XMIT RATE Aperiodic
 SIGNAL TYPE Discrete
 UNITS N/A

BIT NO.	DESCRIPTION
0 msb	-----
1	Hex Digit #1 = 0
2	
3 lsb	-----
4 msb	-----
5	Hex Digit #2 = 0
6	
7 lsb	-----
8 msb	-----
9	Hex Digit #3 = 0
10	
11 lsb	-----
12 msb	-----
13	Hex Digit #4 = 7
14	
15 lsb	-----

WORD NAME Info Type and Number

WORD ID:	R1-007-02	RANGE:	N/A
SOURCE:	BC	ACCURACY:	N/A
DESTINATION:	R/R	lsb:	N/A
XMIT RATE	Aperiodic		
SIGNAL TYPE	Discrete		
UNITS	N/A		

BIT NO. DESCRIPTION

0	msb	Bit 0 is the Info request type: 0 = file, 1 = event
1		Binary 0
2		Binary 0
3		Binary 0
4		Binary 0
5		Binary 0
6		Bit 6 - 15 is the unsigned binary integer file number
7		when Bit 0 = 0 or the unsigned binary integer
8		event number when Bit 0 = 1. Bit 6 is the msb
9		and Bit 15 is the lsb
10		
11		
12		
13		
14		
15	lsb	

WORD NAME: Info Event Occurrence

WORD ID:	R1-007-03	RANGE:	N/A
SOURCE:	BC	ACCURACY:	N/A
DESTINATION:	R/R	lsb:	N/A
XMIT RATE	Aperiodic		
SIGNAL TYPE	Discrete		
UNITS	N/A		

BIT NO. DESCRIPTION

0	msb	Bit 0 - 15 is the unsigned integer event occurrence number of
1		the event specified in data word 2 bits 6-15 when Bit 0 of data
2		word 2 = 1, otherwise this data word 3 is unused (zero) when
3		Bit 0 of data word 2 = 0. Bit 0 is the msb and Bit 15 is the lsb
4		
5		

6
7
8
9
10
11
12
13
14
15 lsb

A.1.g. Pause Command

The Pause command is used to instruct the R/R to suspend recording of one or more channels, either by channel type or specific channel IDs.

MESSAGE NAME: Pause

MESSAGE ID: R1-008 TRANSFER TYPE: BC-RT
SOURCE: BC WORD COUNT: 32
DESTINATION: R/R

WORD NAME	WORD NO.	DESCRIPTION
Command Word	CW	Subaddress 00001 binary
Pause Command ID	01	ID of Pause command = 0x0008
Pause Condition	02	Channel group or individual channels
Pause Channel ID	03-16	Individual Channel ID or zero
Zero	17-32	Zero-filled
Status Word	SW	MIL-STD-1553 Status Word

WORD NAME: Pause Command ID

WORD ID: R1-008-01 RANGE: N/A
SOURCE: BC ACCURACY: N/A
DESTINATION: R/R lsb: N/A
XMIT RATE Aperiodic
SIGNAL TYPE Discrete
UNITS N/A

BIT NO.	DESCRIPTION
0 msb	-----
1	Hex Digit #1 = 0
2	
3 lsb	-----

4	msb	-----
5		Hex Digit #2 = 0
6		
7	lsb	-----
8	msb	-----
9		Hex Digit #3 = 0
10		
11	lsb	-----
12	msb	-----
13		Hex Digit #4 = 8
14		
15	lsb	-----

WORD NAME: Pause Condition

WORD ID:	R1-008-02	RANGE:	N/A
SOURCE:	BC	ACCURACY:	N/A
DESTINATION:	R/R	lsb:	N/A
XMIT RATE	Aperiodic		
SIGNAL TYPE	Discrete		
UNITS	N/A		

BIT NO. DESCRIPTION

0 msb Binary 0

Bits 1-3 are a three-bit code that specify the type of pause

Bit No.	123	
	000	= Individual Channel(s)
	001	= All Channels
		Remaining bits reserved

4		Binary 0
5		Binary 0
7		Binary 0
8		Binary 0
9		Binary 0
10		Binary 0
11		Binary 0
12		Binary 0
13		Binary 0
14		Binary 0
15	lsb	Binary 0

WORD NAME: Pause Channel ID

WORD ID:	R1-008-03 to R1-008-16	RANGE:	N/A
SOURCE:	BC	ACCURACY:	N/A
DESTINATION:	R/R	lsb:	N/A
XMIT RATE	Aperiodic		
SIGNAL TYPE	Discrete		
UNITS	N/A		

BIT NO. DESCRIPTION

0	msb	Bit 0 - 15 is the unsigned integer Channel ID number of a channel to be paused when Bits 1-3 of data word 2 equal 110, otherwise these data words 3 to 16 are unused and zero-filled.
1		
2		
3		
4		
5		
6		
7		
8		
9		
10		
11		
12		
13		
14		
15	lsb	

A.1.h. Queue Command

The Queue command is used to specify a recorded data file or defined data event at which to begin the next replay. Replay must be stopped prior to issuing the Queue command.

MESSAGE NAME: Queue

MESSAGE ID:	R1-011	TRANSFER TYPE:	BC-RT
SOURCE:	BC	WORD COUNT:	32
DESTINATION:	R/R		

WORD NAME	WORD NO.	DESCRIPTION
Command Word	CW	Subaddress 00001 binary
Queue Command ID	01	ID of Queue command = 0x000B
Queue Mode/Number	02	Queue type and file or event number
Queue Event Occurrence	03	Specific occurrence when type = event
Zero	4-32	Zero-filled
Status Word	SW	MIL-STD-1553 Status Word

WORD NAME: Queue Command ID

WORD ID:	R1-011-01	RANGE:	N/A
SOURCE:	BC	ACCURACY:	N/A
DESTINATION:	R/R	lsb:	N/A
XMIT RATE	Aperiodic		
SIGNAL TYPE	Discrete		
UNITS	N/A		

BIT NO.		DESCRIPTION
0	msb	-----
1		Hex Digit #1 = 0
2		
3	lsb	-----
4	msb	-----
5		Hex Digit #2 = 0
6		
7	lsb	-----
8	msb	-----
9		Hex Digit #3 = 0
10		
11	lsb	-----
12	msb	-----
13		Hex Digit #4 = B
14		
15	lsb	-----

WORD NAME: Queue Mode/Number

WORD ID:	R1-011-02	RANGE:	N/A
SOURCE:	BC	ACCURACY:	N/A
DESTINATION:	R/R	lsb:	N/A
XMIT RATE	Aperiodic		
SIGNAL TYPE	Discrete		
UNITS	N/A		

BIT NO.		DESCRIPTION
0	msb	Bit 0 is the Queue request type: 0 = file, 1 = event
1		Binary 0
2		Binary 0
3		Binary 0
4		Binary 0

5 Binary 0
 6 Bit 6 - 15 is the unsigned binary integer file number
 7 when Bit 0 = 0 or the unsigned binary integer
 8 event number when Bit 0 = 1. Bit 6 is the msb
 9 and Bit 15 is the lsb
 10
 11
 12
 13
 14
 15 lsb

WORD NAME: Queue Event Occurrence

WORD ID:	R1-011-03	RANGE:	N/A
SOURCE:	BC	ACCURACY:	N/A
DESTINATION:	R/R	lsb:	N/A
XMIT RATE	Aperiodic		
SIGNAL TYPE	Discrete		
UNITS	N/A		

BIT NO.	DESCRIPTION
0 msb	Bit 0 - 15 is the unsigned integer event occurrence number of the event specified in data word 2 bits 6-15 when Bit 0 of data word 2 = 1, otherwise this data word 3 is unused (zero) when Bit 0 of data word 2 = 0. Bit 0 is the msb and Bit 15 is the lsb
1	
2	
3	
4	
5	
6	
7	
8	
9	
10	
11	
12	
13	
14	
15 lsb	

A.1.i. Record Command

The Record command is used to open a new file in the R/R internal memory or RMM file table and start recording data. While in the Record state or Record and Play state, the percent of drive filled (total minus remaining) is output via the STATUS transmit command.

MESSAGE NAME: Record

MESSAGE ID: R1-012 TRANSFER TYPE: BC-RT
 SOURCE: BC WORD COUNT: 32
 DESTINATION: R/R

WORD NAME	WORD NO.	DESCRIPTION
Command Word	CW	Subaddress 00001 binary
Record Command ID	01	ID of Record command = 0x000C
Zero	02-32	Zero-filled
Status Word	SW	MIL-STD-1553 Status Word

WORD NAME: Record Command ID

WORD ID: R1-012-01 RANGE: N/A
 SOURCE: BC ACCURACY: N/A
 DESTINATION: R/R lsb: N/A
 XMIT RATE Aperiodic
 SIGNAL TYPE Discrete
 UNITS N/A

BIT NO.	DESCRIPTION
0 msb	-----
1	Hex Digit #1 = 0
2	
3 lsb	-----
4 msb	-----
5	Hex Digit #2 = 0
6	
7 lsb	-----
8 msb	-----
9	Hex Digit #3 = 0
10	
11 lsb	-----
12 msb	-----
13	Hex Digit #4 = C
14	
15 lsb	-----

A.1.j. Replay Command

The Replay command is used to start, pause, continue, and control the speed of replay of the recorded data.

MESSAGE NAME: Replay

MESSAGE ID: R1-009 TRANSFER TYPE: BC-RT
 SOURCE: BC WORD COUNT: 32
 DESTINATION: R/R

WORD NAME	WORD NO.	DESCRIPTION
Command Word	CW	Subaddress 00001 binary
Replay Command ID	01	ID of Replay command = 0x0009
Replay Type/Speed	02	Start/continue and speed control
Replay Time Word 1	03	Start time seconds/milliseconds
Replay Time Word 2	04	Start time hours/minutes
Replay Time Word 3	05	Start time month/days
Replay Time Word 4	06	Start time year
Zero	07-32	Zero-filled
Status Word	SW	MIL-STD-1553 Status Word

WORD NAME: Replay Command ID

WORD ID: R1-009-01 RANGE: N/A
 SOURCE: BC ACCURACY: N/A
 DESTINATION: R/R lsb: N/A
 XMIT RATE Aperiodic
 SIGNAL TYPE Discrete
 UNITS N/A

BIT NO.	DESCRIPTION
0 msb	-----
1	Hex Digit #1 = 0
2	
3 lsb	-----
4 msb	-----
5	Hex Digit #2 = 0
6	
7 lsb	-----
8 msb	-----
9	Hex Digit #3 = 0
10	
11 lsb	-----
12 msb	-----
13	Hex Digit #4 = 9
14	
15 lsb	-----

WORD NAME: Replay Type/Speed

WORD ID:	R1-009-02	RANGE:	N/A
SOURCE:	BC	ACCURACY:	N/A
DESTINATION:	R/R	lsb:	N/A
XMIT RATE	Aperiodic		
SIGNAL TYPE	Discrete		
UNITS	N/A		

BIT NO. DESCRIPTION

0 msb Bits 0-3: A series of binary values representing the type of replay.
Bit No. 0123

0000 = Begin Replay @ Time and Speed¹
0001 = Play Live (ignore bits 4-7)
0010 = Continue Replay @ Speed²
0011 - 1111 = Reserved

 Bits 4-7: A series of binary values indicating replay speed.
Bit No. 4567

0000 = Pause (Speed Zero)
0001 = Normal Speed (real-time)
0010 - 1111 per R/R Specification

15 lsb Bit 8 - 15 Binary 0

Note 1: Begin Replay @ Time and Speed command option is only valid when replay is currently stopped (see STOP receive command). The Replay message time words (data words 3-6) are used to locate the desired replay point. If the time specified in these replay time words is not found in the recorded data, the R/R will set the Last Receive Command Error bit in the Status transmit message.

Note 2: Continue Replay @ Speed command option is used following a Queue command to initiate replay at the queued replay point. It is also used to change replay speeds or pause and resume replay at the current replay point. The Replay message time words are unused and zero-filled.

WORD NAME Replay Time Word 1

WORD ID:	R1-009-03	RANGE:	N/A
SOURCE:	BC	ACCURACY:	N/A
DESTINATION:	R/R	lsb:	N/A
XMIT RATE	Aperiodic		
SIGNAL TYPE	Discrete		
UNITS	N/A		

BIT NO.		DESCRIPTION
0	msb	-----
1		Hex Digit #1 = Tens of seconds, binary 0 to 5
2		
3	lsb	-----
4	msb	-----
5		Hex Digit #2 = Units of seconds, binary 0 to 9
6		
7	lsb	-----
8	msb	-----
9		Hex Digit #3 = Hundreds of milliseconds, binary 0 to 9
10		
11	lsb	-----
12	msb	-----
13		Hex Digit #4 = Tens of milliseconds, binary 0 to 9
14		
15	lsb	-----

WORD NAME Replay Time Word 2

WORD ID:	R1-009-04	RANGE:	N/A
SOURCE:	BC	ACCURACY:	N/A
DESTINATION:	R/R	lsb:	N/A
XMIT RATE	Aperiodic		
SIGNAL TYPE	Discrete		
UNITS	N/A		

BIT NO.		DESCRIPTION
0	msb	-----
1		Hex Digit #1 = Tens of hours, binary 0 to 2 ¹
2		
3	lsb	-----
4	msb	-----
5		Hex Digit #2 = Units of hours, binary 0 to 9 ¹
6		
7	lsb	-----
8	msb	-----
9		Hex Digit #3 = Tens of minutes, binary 0 to 5
10		
11	lsb	-----
12	msb	-----
13		Hex Digit #4 = Units of minutes, binary 0 to 9
14		

15 lsb -----

Note 1. Hex digit #1 and hex digit #2 (tens of hours and units of hours) must together be a decimal number from 00 to 23

WORD NAME Replay Time Word 3

WORD ID:	R1-009-05	RANGE:	N/A
SOURCE:	BC	ACCURACY:	N/A
DESTINATION:	R/R	lsb:	N/A
XMIT RATE	Aperiodic		
SIGNAL TYPE	Discrete		
UNITS	N/A		

BIT NO.	DESCRIPTION
0 msb	-----
1	Hex Digit #1 = Tens of months, binary 0 to 1 ¹
2	
3 lsb	-----
4 msb	-----
5	Hex Digit #2 = Units of months, binary 0 to 9 ¹
6	
7 lsb	-----
8 msb	-----
9	Hex Digit #3 = Tens of days, binary 0 to 3 ^{2,3}
10	
11 lsb	-----
12 msb	-----
13	Hex Digit #4 = Units of days, binary 0 to 9 ^{2,3}
14	
15 lsb	-----

Note 1. Hex digit #1 and hex digit #2 (tens of months and units of months) must together be a decimal number from 01 to 12

Note 2. Hex digit #3 and hex digit #4 (tens of days and units of days) must together be a decimal number from 01 to 31

Note 3. Hex digit #3 and hex digit #4 (tens of days and units of days) must together be a valid number of days in the month identified by hex digit #1 and hex digit #2. For example, month 06 may only have a maximum of 30 days.

WORD NAME Replay Time Word 4

WORD ID:	R1-009-06	RANGE:	N/A
----------	-----------	--------	-----

SOURCE: BC ACCURACY: N/A
 DESTINATION: R/R lsb: N/A
 XMIT RATE Aperiodic
 SIGNAL TYPE Discrete
 UNITS N/A

BIT NO.	DESCRIPTION
0 msb	-----
1	Hex Digit #1 = Thousands of years, binary 0 to 2
2	
3 lsb	-----
4 msb	-----
5	Hex Digit #2 = Hundreds of years, binary 0 to 9
6	
7 lsb	-----
8 msb	-----
9	Hex Digit #3 = Tens of years, binary 0 to 9
10	
11 lsb	-----
12 msb	-----
13	Hex Digit #4 = Units of years, binary 0 to 9
14	
15 lsb	-----

A.1.k. Reset Command

The Reset command is used to start a reset of the R/R. Upon receipt of a valid Reset command, the R/R negates the ready discrete output and all subsequent RT messages addressed to the R/R will be ignored until the ready discrete output is reasserted.

MESSAGE NAME: Reset

MESSAGE ID: R1-013 TRANSFER TYPE: BC-RT
 SOURCE: BC WORD COUNT: 32
 DESTINATION: R/R

WORD NAME	WORD NO.	DESCRIPTION
Command Word	CW	Subaddress 00001 binary
Reset Command ID	01	ID of Reset command = 0x000D
Zero	02-32	Zero-filled
Status Word	SW	MIL-STD-1553 Status Word

WORD NAME: Reset Command ID

WORD ID: R1-013-01 RANGE: N/A

SOURCE: BC ACCURACY: N/A
 DESTINATION: R/R lsb: N/A
 XMIT RATE Aperiodic
 SIGNAL TYPE Discrete
 UNITS N/A

BIT NO.	DESCRIPTION
0 msb	-----
1	Hex Digit #1 = 0
2	
3 lsb	-----
4 msb	-----
5	Hex Digit #2 = 0
6	
7 lsb	-----
8 msb	-----
9	Hex Digit #3 = 0
10	
11 lsb	-----
12 msb	-----
13	Hex Digit #4 = D
14	
15 lsb	-----

A.1.1. Resume Command

The Resume command is used to instruct the R/R to resume recording of one or more channels, either by channel type or specific channel IDs.

MESSAGE NAME: Resume

MESSAGE ID: R1-014 TRANSFER TYPE: BC-RT
 SOURCE: BC WORD COUNT: 32
 DESTINATION: R/R

WORD NAME	WORD NO.	DESCRIPTION
Command Word	CW	Subaddress 00001 binary
Resume Command ID	01	ID of Resume command = 0x000E
Resume Condition	02	Channel group or individual channels
Resume Channel ID	03-16	Individual Channel ID or zero
Zero	17-32	Zero-filled
Status Word	SW	MIL-STD-1553 Status Word

WORD NAME: Resume Command ID

WORD ID:	R1-014-01	RANGE:	N/A
SOURCE:	BC	ACCURACY:	N/A
DESTINATION:	R/R	lsb:	N/A
XMIT RATE	Aperiodic		
SIGNAL TYPE	Discrete		
UNITS	N/A		

BIT NO.	DESCRIPTION
0	msb -----
1	Hex Digit #1 = 0
2	
3	lsb -----
4	msb -----
5	Hex Digit #2 = 0
6	
7	lsb -----
8	msb -----
9	Hex Digit #3 = 0
10	
11	lsb -----
12	msb -----
13	Hex Digit #4 = E
14	
15	lsb -----

WORD NAME: Resume Condition

WORD ID:	R1-014-02	RANGE:	N/A
SOURCE:	BC	ACCURACY:	N/A
DESTINATION:	R/R	lsb:	N/A
XMIT RATE	Aperiodic		
SIGNAL TYPE	Discrete		
UNITS	N/A		

BIT NO.	DESCRIPTION
---------	-------------

0	msb	Binary 0
Bits 1-3 are three-bit codes that specify the type of resume		

Bit No.	123	
	000	= Individual Channel(s)
	001	= All Channels
		Remaining bits reserved

4		Binary 0
5		Binary 0
7		Binary 0
8		Binary 0
9		Binary 0
10		Binary 0
11		Binary 0
12		Binary 0
13		Binary 0
14		Binary 0
15	lsb	Binary 0

WORD NAME: Resume Channel ID

WORD ID:	R1-014-03 to R1-014-16	RANGE:	N/A
SOURCE:	BC	ACCURACY:	N/A
DESTINATION:	R/R	lsb:	N/A
XMIT RATE	Aperiodic		
SIGNAL TYPE	Discrete		
UNITS	N/A		

BIT NO.		DESCRIPTION
0	msb	Bit 0 - 15 is the unsigned integer Channel ID number of a channel to be resumed when Bits 1-3 of data word 2 equal 110, otherwise these data words 3 to 16 are unused and zero-filled.
1		
2		
3		
4		
5		
6		
7		
8		
9		
10		
11		
12		
13		
14		
15	lsb	

A.1.m. Sanitize Command

The Sanitize command performs a Chapter 10 sanitization procedure on internal memory or RMM installed in the R/R. While in the Sanitize state, the percent complete is output via the STATUS transmit command. When the Sanitize procedure completes, the state of the R/R as

returned by the STATUS transmit command indicates either “pass” (state = SANITIZE PASS) or “fail” (state = SANITIZE FAIL).

MESSAGE NAME: Sanitize

MESSAGE ID: R1-003 TRANSFER TYPE: BC-RT
 SOURCE: BC WORD COUNT: 32
 DESTINATION: R/R

WORD NAME	WORD NO.	DESCRIPTION
Command Word	CW	Subaddress 00001 binary
Sanitize Command ID	01	ID of Sanitize command = 0x0003
Zero	2-32	Zero-filled
Status Word	SW	MIL-STD-1553 Status Word

WORD NAME: Sanitize Command ID

WORD ID: R1-003-01 RANGE: N/A
 SOURCE: BC ACCURACY: N/A
 DESTINATION: R/R lsb: N/A
 XMIT RATE Aperiodic
 SIGNAL TYPE Discrete
 UNITS N/A

BIT NO.	DESCRIPTION
0 msb	-----
1	Hex Digit #1 = 0
2	
3 lsb	-----
4 msb	-----
5	Hex Digit #2 = 0
6	
7 lsb	-----
8 msb	-----
9	Hex Digit #3 = 0
10	
11 lsb	-----
12 msb	-----
13	Hex Digit #4 = 3
14	
15 lsb	-----

A.1.n. Stop Command

The Stop command is used to stop recording, replay, or both.

MESSAGE NAME: Stop

MESSAGE ID: R1-016 TRANSFER TYPE: BC-RT

SOURCE: BC WORD COUNT: 32

DESTINATION: R/R

WORD NAME	WORD NO.	DESCRIPTION
Command Word	CW	Subaddress 00001 binary
Stop Command ID	01	ID of Stop command = 0x0010
Stop Mode	02	One of three possible stop modes
Zero	03-32	Zero-filled
Status Word	SW	MIL-STD-1553 Status Word

WORD NAME: Stop Command ID

WORD ID: R1-016-01 RANGE: N/A

SOURCE: BC ACCURACY: N/A

DESTINATION: R/R lsb: N/A

XMIT RATE Aperiodic

SIGNAL TYPE Discrete

UNITS N/A

BIT NO.	DESCRIPTION
0 msb	-----
1	Hex Digit #1 = 0
2	
3 lsb	-----
4 msb	-----
5	Hex Digit #2 = 0
6	
7 lsb	-----
8 msb	-----
9	Hex Digit #3 = 1
10	
11 lsb	-----
12 msb	-----
13	Hex Digit #4 = 0
14	
15 lsb	-----

WORD NAME	WORD NO.	DESCRIPTION
Command Word	CW	Subaddress 00001 binary
Time Command ID	01	ID of Time command = 0x0011
Set Time Valid	02	Indicates when words 4-7 have valid time
Time of Validity	03	Indicates sync time when time was valid
Set Time Word 1	04	Seconds and Milliseconds word
Set Time Word 2	05	Hours and Minutes word
Set Time Word 3	06	Month and Day word
Set Time Word 4	07	Year word
Zero	8-32	Zero-filled
Status Word	SW	MIL-STD-1553 Status Word

WORD NAME: Time Command ID

WORD ID: R1-017-01 RANGE: N/A
 SOURCE: BC ACCURACY: N/A
 DESTINATION: R/R lsb: N/A
 XMIT RATE Aperiodic
 SIGNAL TYPE Discrete
 UNITS N/A

BIT NO.	DESCRIPTION
0 msb	-----
1	Hex Digit #1 = 0
2	
3 lsb	-----
4 msb	-----
5	Hex Digit #2 = 0
6	
7 lsb	-----
8 msb	-----
9	Hex Digit #3 = 1
10	
11 lsb	-----
12 msb	-----
13	Hex Digit #4 = 1
14	
15 lsb	-----

WORD NAME Set Time Valid

WORD ID: R1-017-02 RANGE: N/A
 SOURCE: BC ACCURACY: N/A

10
 11
 12
 13
 14
 15 lsb

WORD NAME Set Time Word 1

WORD ID: R1-017-04 RANGE: N/A
 SOURCE: BC ACCURACY: N/A
 DESTINATION: R/R lsb: N/A
 XMIT RATE Aperiodic
 SIGNAL TYPE Discrete
 UNITS N/A

BIT NO.	DESCRIPTION
0 msb	-----
1	Hex Digit #1 = Tens of seconds, binary 0 to 5
2	
3 lsb	-----
4 msb	-----
5	Hex Digit #2 = Units of seconds, binary 0 to 9
6	
7 lsb	-----
8 msb	-----
9	Hex Digit #3 = Hundreds of milliseconds, binary 0 to 9
10	
11 lsb	-----
12 msb	-----
13	Hex Digit #4 = Tens of milliseconds, binary 0 to 9
14	
15 lsb	-----

WORD NAME Set Time Word 2

WORD ID: R1-017-05 RANGE: N/A
 SOURCE: BC ACCURACY: N/A
 DESTINATION: R/R lsb: N/A
 XMIT RATE Aperiodic
 SIGNAL TYPE Discrete
 UNITS N/A

BIT NO.		DESCRIPTION
0	msb	-----
1		Hex Digit #1 = Tens of hours, binary 0 to 2 ¹
2		
3	lsb	-----
4	msb	-----
5		Hex Digit #2 = Units of hours, binary 0 to 9 ¹
6		
7	lsb	-----
8	msb	-----
9		Hex Digit #3 = Tens of minutes, binary 0 to 5
10		
11	lsb	-----
12	msb	-----
13		Hex Digit #4 = Units of minutes, binary 0 to 9
14		
15	lsb	-----

Note 1. Hex digit #1 and hex digit #2 (tens of hours and units of hours) must together be a decimal number from 00 to 23

WORD NAME	Set Time Word 3		
WORD ID:	R1-017-06	RANGE:	N/A
SOURCE:	BC	ACCURACY:	N/A
DESTINATION:	R/R	lsb:	N/A
XMIT RATE	Aperiodic		
SIGNAL TYPE	Discrete		
UNITS	N/A		

BIT NO.		DESCRIPTION
0	msb	-----
1		Hex Digit #1 = Tens of months, binary 0 to 1 ¹
2		
3	lsb	-----
4	msb	-----
5		Hex Digit #2 = Units of months, binary 0 to 9 ¹
6		
7	lsb	-----
8	msb	-----
9		Hex Digit #3 = Tens of days, binary 0 to 3 ^{2,3}
10		
11	lsb	-----
12	msb	-----

13 Hex Digit #4 = Units of days, binary 0 to 9^{2, 3}
 14
 15 lsb -----

- Note 1. Hex digit #1 and hex digit #2 (tens of months and units of months) must together be a decimal number from 01 to 12
- Note 2. Hex digit #3 and hex digit #4 (tens of days and units of days) must together be a decimal number from 01 to 31
- Note 3. Hex digit #3 and hex digit #4 (tens of days and units of days) must together be a valid number of days in the month identified by hex digit #1 and hex digit #2. For example, month 06 may only have a maximum of 30 days.

WORD NAME Set Time Word 4

WORD ID: R1-017-07 RANGE: N/A
 SOURCE: BC ACCURACY: N/A
 DESTINATION: R/R lsb: N/A
 XMIT RATE Aperiodic
 SIGNAL TYPE Discrete
 UNITS N/A

BIT NO.	DESCRIPTION
0 msb	-----
1	Hex Digit #1 = Thousands of years, binary 0 to 2
2	
3 lsb	-----
4 msb	-----
5	Hex Digit #2 = Hundreds of years, binary 0 to 9
6	
7 lsb	-----
8 msb	-----
9	Hex Digit #3 = Tens of years, binary 0 to 9
10	
11 lsb	-----
12 msb	-----
13	Hex Digit #4 = Units of years, binary 0 to 9
14	
15 lsb	-----

A.1.p. Sync Command

The Sync command is used to send the current value of the BC clock synchronization time to the R/R.

MESSAGE NAME: Sync

MESSAGE ID: R2 TRANSFER TYPE: BC-RT
 SOURCE: BC WORD COUNT: 1
 DESTINATION: R/R

WORD NAME	WORD NO.	DESCRIPTION
Command Word	CW	Subaddress 00010 binary
Synchronization Time	01	BC Clock Synchronization Time
Status Word	SW	MIL-STD-1553 Status Word

WORD NAME: Synchronization Time

WORD ID: R2-01 RANGE: N/A
 SOURCE: BC ACCURACY: N/A
 DESTINATION: R/R lsb: 50 microseconds
 XMIT RATE Aperiodic
 SIGNAL TYPE Discrete
 UNITS N/A

BIT NO.	DESCRIPTION
0 msb	-----
1	
2	
3	
4	
5	
6	
7	
8	
9	
10	
11	
12	
13	
14	
15 lsb	-----

Note: 50 microsecond count used to synchronize the internal R/R clock to the BC clock. When a TIME command is received by the R/R, the most recent SYNC command clock synchronization word is used to calculate the correct time to load into the R/R clock based on the time of validity parameter contained in the TIME command.

A.2. Transmit Messages

[Table A-2](#) provides a description of the MIL-STD-1553 transmit commands defined in the following sections.

Table A-2. Military Standard 1553 Transmit (Remote Terminal to Bus Controller) Command Set		
Command	Subaddress	Description
EVENTS	2	Returns the number of occurrences of defined events
HEALTH	3	Returns detailed R/R health information
INFO	4	Returns detailed information about a specific file or event in response to a received INFO BC to RT message (see Table A-1)
STATUS	5	Returns the current system status and statistics

A.2.a. Transmit Message Length

All response (transmit) messages have 32 data words. All unused data words are zero-filled. If the BC requests less than 32 words in the RT to BC command word, only a valid status word and the requested number of data words will be transmitted.

A.2.b. Events Command

Each time the BC sends an Event command (R1-005 above), the R/R will increment the internal “occurrence” counter for the specified event. This Event command causes the R/R to transmit the number of occurrences of events 1 to 31. Undefined event occurrence counts are 0.

MESSAGE NAME: Events

MESSAGE ID: T3 TRANSFER TYPE: RT - BC
SOURCE: R/R WORD COUNT: 32
DESTINATION: BC

<u>WORD NAME</u>	<u>WORD NO.</u>	<u>DESCRIPTION</u>
Command Word	CW	Subaddress 00011 binary
Status Word	SW	MIL-STD-1553 Status Word
Event 1 Occurrences	01	Number of times Event 1 occurred
Event 2 Occurrences	02	Number of times Event 2 occurred
Event 3 Occurrences	03	Number of times Event 3 occurred
Event 4 Occurrences	04	Number of times Event 4 occurred
Event 5 Occurrences	05	Number of times Event 5 occurred
Event 6 Occurrences	06	Number of times Event 6 occurred
Event 7 Occurrences	07	Number of times Event 7 occurred
Event 8 Occurrences	08	Number of times Event 8 occurred
Event 9 Occurrences	09	Number of times Event 9 occurred
Event 10 Occurrences	10	Number of times Event 10 occurred
Event 11 Occurrences	11	Number of times Event 11 occurred
Event 12 Occurrences	12	Number of times Event 12 occurred

Event 13 Occurrences	13	Number of times Event 13 occurred
Event 14 Occurrences	14	Number of times Event 14 occurred
Event 15 Occurrences	15	Number of times Event 15 occurred
Event 16 Occurrences	16	Number of times Event 16 occurred
Event 17 Occurrences	17	Number of times Event 17 occurred
Event 18 Occurrences	18	Number of times Event 18 occurred
Event 19 Occurrences	19	Number of times Event 19 occurred
Event 20 Occurrences	20	Number of times Event 20 occurred
Event 21 Occurrences	21	Number of times Event 21 occurred
Event 22 Occurrences	22	Number of times Event 22 occurred
Event 23 Occurrences	23	Number of times Event 23 occurred
Event 24 Occurrences	24	Number of times Event 24 occurred
Event 25 Occurrences	25	Number of times Event 25 occurred
Event 26 Occurrences	26	Number of times Event 26 occurred
Event 27 Occurrences	27	Number of times Event 27 occurred
Event 28 Occurrences	28	Number of times Event 28 occurred
Event 29 Occurrences	29	Number of times Event 29 occurred
Event 30 Occurrences	30	Number of times Event 30 occurred
Event 31 Occurrences	31	Number of times Event 31 occurred
Zero	32	Zero-filled

WORD NAME: Event N Occurrences

WORD ID:	T3-01 to T3-31	RANGE:	0 - 65535
SOURCE:	R/R	ACCURACY:	N/A
DESTINATION:	BC	lsb:	N/A
XMIT RATE	Periodic		
SIGNAL TYPE	Discrete		
UNITS	N/A		

BIT NO.		DESCRIPTION
0	msb	Bit 0 - 15 is the unsigned integer number of times that the corresponding Event occurred or zero if the corresponding event is undefined.
1		
2		
3		
4		
5		
6		
7		
8		
9		
10		
11		
12		

13
14
15 lsb

A.2.c. Health Command

The Health command returns status bits that indicate warning or error conditions within the R/R. Any non-zero health bit is either a warning condition or an error condition. Detailed health bit descriptions are provided in [Table 6-2](#).

MESSAGE NAME: Health

MESSAGE ID: T4 TRANSFER TYPE: RT - BC
SOURCE: R/R WORD COUNT: 32
DESTINATION: BC

WORD NAME	WORD NO.	DESCRIPTION
Command Word	CW	Subaddress 00100 binary Subaddresses 00111 - 10000 binary are used to extend Health command channel health word count.
Status Word	SW	MIL-STD-1553 Status Word
Recorder Health	01	Recorder and RMM status bits
Channel Health	02-32	Individual channel status bits

Note: Channel health status bits are IAW the .HEALTH command defined in Subsection [6.2.3.3](#).

Time Channel Health 02 Time channel status bits

WORD NAME: Recorder Health

WORD ID: T4-01 RANGE: N/A
SOURCE: R/R ACCURACY: N/A
DESTINATION: BC lsb: N/A
XMIT RATE: Periodic
SIGNAL TYPE: Discrete
UNITS: N/A

BIT NO.	DESCRIPTION
0 msb	IAW .HEALTH use of status bits table (ch6)
1	IAW .HEALTH use of status bits table
2	IAW .HEALTH use of status bits table
3	IAW .HEALTH use of status bits table

4		IAW .HEALTH use of status bits table
5		IAW .HEALTH use of status bits table
6		IAW .HEALTH use of status bits table
7		IAW .HEALTH use of status bits table
8		IAW .HEALTH use of status bits table
9		Drive Full
10		Drive I/O Failure
11		No Drive
12		Unused (zero)
13		Operation Failure
14		Setup Failure
15	lsb	Bit Failure

WORD NAME: Time Channel Health

WORD ID:	T4-02	RANGE:	N/A
SOURCE:	R/R	ACCURACY:	N/A
DESTINATION:	BC	lsb:	N/A
XMIT RATE	Periodic		
SIGNAL TYPE	Discrete		
UNITS	N/A		

BIT NO.		DESCRIPTION
0	msb	IAW .HEALTH use of status bits table
1		IAW .HEALTH use of status bits table
2		IAW .HEALTH use of status bits table
3		IAW .HEALTH use of status bits table
4		IAW .HEALTH use of status bits table
5		IAW .HEALTH use of status bits table
6		IAW .HEALTH use of status bits table
7		IAW .HEALTH use of status bits table
8		IAW .HEALTH use of status bits table
9		IAW .HEALTH use of status bits table
10		IAW .HEALTH use of status bits table
11		Synchronization Failure
12		Bad External Signal
13		No External Signal
14		Setup Failure
15	lsb	Bit Failure

WORD NAME: Channel (n) Health

WORD ID:	T4-03 - T4-32	RANGE:	N/A
----------	---------------	--------	-----

SOURCE:	R/R	ACCURACY:	N/A
DESTINATION:	BC	lsb:	N/A
XMIT RATE	Periodic		
SIGNAL TYPE	Discrete		
UNITS	N/A		

BIT NO.		DESCRIPTION
0	msb	IAW .HEALTH use of status bits table
1		IAW .HEALTH use of status bits table
2		IAW .HEALTH use of status bits table
3		IAW .HEALTH use of status bits table
4		IAW .HEALTH use of status bits table
5		IAW .HEALTH use of status bits table
6		IAW .HEALTH use of status bits table
7		IAW .HEALTH use of status bits table
8		IAW .HEALTH use of status bits table
9		IAW .HEALTH use of status bits table
10		IAW .HEALTH use of status bits table
11		IAW .HEALTH use of status bits table
12		IAW .HEALTH use of status bits table
13		IAW .HEALTH use of status bits table
14		IAW .HEALTH use of status bits table
15	lsb	Bit Failure

A.2.d. Info (transmit) Command

The Info transmit command retrieves internal memory or RMM data file start and end time or an event occurrence time as requested by the most recent Info receive (R1-007) command. Validity bits in data words 1 and 10 indicate when the specific file or event information is valid.

MESSAGE NAME: Info (transmit)

MESSAGE ID:	T5	TRANSFER TYPE:	RT - BC
SOURCE:	R/R	WORD COUNT:	32
DESTINATION:	BC		

WORD NAME	WORD NO.	DESCRIPTION
Command Word	CW	Subaddress 00101 binary
Status Word	SW	MIL-STD-1553 Status Word
File Number	01	Info requested for this file
File Start Time Word 1	02	File start time seconds & milliseconds
File Start Time Word 2	03	File start time hours & minutes
File Start Time Word 3	04	File start time month & days

File Start Time Word 4	05	File start time year
File End Time Word 1	06	File end time seconds & milliseconds
File End Time Word 2	07	File end time hours & minutes
File End Time Word 3	08	File end time month & days
File End Time Word 4	09	File end time year
Event Number	10	Info requested for this event
Event Occurrence	11	Info requested for this occurrence
Event Time Word 1	12	Event time seconds & milliseconds
Event Time Word 2	13	Event time hours & minutes
Event Time Word 3	14	Event time month & days
Event Time Word 4	15	Event time year
Zero	16-32	Zero-filled

WORD NAME: File Number

WORD ID:	T5-01	RANGE:	see below
SOURCE:	R/R	ACCURACY:	N/A
DESTINATION:	BC	lsb:	N/A
XMIT RATE	Periodic		
SIGNAL TYPE	Discrete		
UNITS	N/A		

BIT NO.		DESCRIPTION
0	msb	Bit 0: File Info Validity; Valid = 1, Invalid = 0
1		Bit 1 - 15 is the unsigned integer file number of the requested file from 1 to the number of files in Status message data word 5 (T6-005)
2		
3		
4		
5		
6		
7		
8		
9		
10		
11		
12		
13		
14		
15	lsb	

Note: File Info Validity applies to the file number in this data word and the start and end times in the next eight data words.

WORD NAME File Start, File End, or Event Time Word 1

WORD ID:	T5-02, T5-06, or T5-12	RANGE:	N/A
SOURCE:	R/R	ACCURACY:	N/A
DESTINATION:	BC	lsb:	N/A
XMIT RATE	Periodic		
SIGNAL TYPE	Discrete		
UNITS	N/A		

BIT NO.	DESCRIPTION
0	msb -----
1	Hex Digit #1 = Tens of seconds, binary 0 to 5
2	
3	lsb -----
4	msb -----
5	Hex Digit #2 = Units of seconds, binary 0 to 9
6	
7	lsb -----
8	msb -----
9	Hex Digit #3 = Hundreds of milliseconds, binary 0 to 9
10	
11	lsb -----
12	msb -----
13	Hex Digit #4 = Tens of milliseconds, binary 0 to 9
14	
15	lsb -----

WORD NAME File Start, File End, or Event Time Word 2

WORD ID:	T5-03, T5-07, or T5-13	RANGE:	N/A
SOURCE:	R/R	ACCURACY:	N/A
DESTINATION:	BC	lsb:	N/A
XMIT RATE	Periodic		
SIGNAL TYPE	Discrete		
UNITS	N/A		

BIT NO.	DESCRIPTION
0	msb -----
1	Hex Digit #1 = Tens of hours, binary 0 to 2 ¹
2	
3	lsb -----
4	msb -----
5	Hex Digit #2 = Units of hours, binary 0 to 9 ¹
6	
7	lsb -----

8	msb	-----
9		Hex Digit #3 = Tens of minutes, binary 0 to 5
10		
11	lsb	-----
12	msb	-----
13		Hex Digit #4 = Units of minutes, binary 0 to 9
14		
15	lsb	-----

Note 1. Hex digit #1 and hex digit #2 (tens of hours and units of hours) must together be a decimal number from 00 to 23.

WORD NAME File Start, File End, or Event Time Word 3

WORD ID:	T5-04, T5-08, or T5-14	RANGE:	N/A
SOURCE:	R/R	ACCURACY:	N/A
DESTINATION:	BC	lsb:	N/A
XMIT RATE	Periodic		
SIGNAL TYPE	Discrete		
UNITS	N/A		

BIT NO.		DESCRIPTION
0	msb	-----
1		Hex Digit #1 = Tens of months, binary 0 to 1 ¹
2		
3	lsb	-----
4	msb	-----
5		Hex Digit #2 = Units of months, binary 0 to 9 ¹
6		
7	lsb	-----
8	msb	-----
9		Hex Digit #3 = Tens of days, binary 0 to 3 ^{2,3}
10		
11	lsb	-----
12	msb	-----
13		Hex Digit #4 = Units of days, binary 0 to 9 ^{2,3}
14		
15	lsb	-----

Note 1. Hex digit #1 and hex digit #2 (tens of months and units of months) must together be a decimal number from 01 to 12.

Note 2. Hex digit #3 and hex digit #4 (tens of days and units of days) must together be a decimal number from 01 to 31.

Note 3. Hex digit #3 and hex digit #4 (tens of days and units of days) must together be a valid number of days in the month identified by hex digit #1 and hex digit #2. For example, month 06 may only have a maximum of 30 days.

WORD NAME	File Start, File End, or Event Time Word 4		
WORD ID:	T5-05, T5-09, or T5-15	RANGE:	N/A
SOURCE:	R/R	ACCURACY:	N/A
DESTINATION:	BC	lsb:	N/A
XMIT RATE	Periodic		
SIGNAL TYPE	Discrete		
UNITS	N/A		

BIT NO.		DESCRIPTION
0	msb	-----
1		Hex Digit #1 = Thousands of years, binary 0 to 2
2		
3	lsb	-----
4	msb	-----
5		Hex Digit #2 = Hundreds of years, binary 0 to 9
6		
7	lsb	-----
8	msb	-----
9		Hex Digit #3 = Tens of years, binary 0 to 9
10		
11	lsb	-----
12	msb	-----
13		Hex Digit #4 = Units of years, binary 0 to 9
14		
15	lsb	-----

WORD NAME:	Event Number		
WORD ID:	T5-10	RANGE:	see below
SOURCE:	R/R	ACCURACY:	N/A
DESTINATION:	BC	lsb:	N/A
XMIT RATE	Periodic		
SIGNAL TYPE	Discrete		
UNITS	N/A		

BIT NO.		DESCRIPTION
0	msb	Bit 0: Event Info Validity; Valid = 1, Invalid = 0
1		Bit 1 - 15 is the unsigned integer event number of the requested event

2		from 1 to the number of defined events in Status message data word 14
3		(T6-014)
4		
5		
6		
7		
8		
9		
10		
11		
12		
13		
14		
15	lsb	

Note: Event Info Validity applies to the event number in this data word, the event occurrence number in data word 11, and the event time in data words 12, 13, 14, and 15.

WORD NAME: Event Occurrence

WORD ID:	T5-11	RANGE:	1 - 65535
SOURCE:	R/R	ACCURACY:	N/A
DESTINATION:	BC	lsb:	N/A
XMIT RATE	Periodic		
SIGNAL TYPE	Discrete		
UNITS	N/A		

BIT NO.		DESCRIPTION
0	msb	Bit 0 - 15 is the unsigned integer event occurrence number of the
1		requested BC event
2		
3		
4		
5		
6		
7		
8		
9		
10		
11		
12		
13		
14		
15	lsb	

A.2.e. Status Command

The Status command retrieves R/R status and configuration information. A validity bit in data word 1 indicates when the status and configuration information is valid.

MESSAGE NAME: Status

MESSAGE ID: T6 TRANSFER TYPE: RT - BC
 SOURCE: R/R WORD COUNT: 32
 DESTINATION: BC

WORD NAME	WORD NO.	DESCRIPTION
Command Word	CW	Subaddress 00110 binary
Status Word	SW	MIL-STD-1553 Status Word
State/Speed/Video/Error	01	Multiple system status fields
Command Percent Complete	02	Record/BIT/Erase/Sanitize % complete
Internal Memory/RMM Size	03	Internal Memory/RMM capacity in gigabytes
Memory Percent Available	04	Amount (%) of unused memory
Number of Files	05	Number of used file table entries
System Time Word 1	06	System time seconds & milliseconds
System Time Word 2	07	System time hours & minutes
System Time Word 3	08	System time month & days
System Time Word 4	09	System time year
Replay Time Word 1	10	Current replay time seconds & milliseconds
Replay Time Word 2	11	Current replay hours & minutes
Replay Time Word 3	12	Current replay month & days
Replay Time Word 4	13	Current replay year
Number of Defined Events	14	Number of BC events in TMATS file
Firmware Version	15	Firmware version numbers
TMATS File Revision	16	TMATS Setup File revision number
Zero	17-32	Zero-filled

WORD NAME State/Speed /Error

WORD ID: T6-01 RANGE: N/A
 SOURCE: R/R ACCURACY: N/A
 DESTINATION: BC lsb: N/A
 XMIT RATE Periodic
 SIGNAL TYPE Discrete
 UNITS N/A

BIT NO.	DESCRIPTION
0 msb	Bit 0 - 3 = one of the following state codes

Bit	0123	
		0000 = FAIL
		0001 = IDLE
		0010 = BIT
		0011 = ERASE
		0100 = SANITIZE
		0101 = RECORD
		0110 = PLAY
		0111 = RECORD & PLAY
		1000 = QUEUE (FIND)
		1001 = BUSY
		1010 = COMMAND ERROR
		1011 = SANITIZE ERROR
		1100 = SANITIZE PASS
		1101-1111 = Reserved
		Bit 4 - 7 = binary value representing current replay speed
Bit	4567	
		0000 = Pause (Speed Zero)
		0001 = Normal Speed (Real-Time)
		0010 - 1111 = User Defined
		Bits 8-10: Reserved
		Bit 11: Last Receive Command Error
		0 = Last BC to RT command was valid and accepted
		1 = Last BC to RT command was illegal/invalid and rejected
		Bit 12: Status message validity
		0 = All message words are invalid
		1 = All message words are valid
		Bits 13-14: Queue command status
Bit	13 14	
	0 0	= No queue command status
	0 1	= Queue command passed
	1 0	= Queue command failed
	1 1	= Queue command in progress
15	lsb	Play Live Mode status ¹
		0 = Not in Play Live mode
		1 = In Play Live mode

Note 1. Play Live Mode status is cleared by the Stop Replay command.

WORD NAME: Command Percent Complete

WORD ID:	T6-02	RANGE:	0 - 100
SOURCE:	R/R	ACCURACY:	N/A
DESTINATION:	BC	lsb:	N/A
XMIT RATE	Periodic		
SIGNAL TYPE	Discrete		
UNITS	N/A		

BIT NO.	DESCRIPTION
0	msb Bit 0 - 15 is the unsigned integer percent complete for the Record, Record & Play, BIT, Erase, or Sanitize command when the R/R is in the corresponding state as specified by data word 1 (T6-01) bits 0-3. In the Record & Play state, the percent complete applies to the recording.
1	
2	
3	
4	
5	
6	
7	
8	
9	
10	
11	
12	
13	
14	
15	lsb

WORD NAME: Internal Memory/RMM Size

WORD ID:	T6-03	RANGE:	N/A
SOURCE:	R/R	ACCURACY:	N/A
DESTINATION:	BC	lsb:	N/A
XMIT RATE	Periodic		
SIGNAL TYPE	Discrete		
UNITS	N/A		

BIT NO.	DESCRIPTION
0	msb Bit 0 - 15 is the unsigned integer capacity of the Internal Memory/RMM in Gigabytes (example: 64 = 64,000,000,000 bytes)
1	
2	
3	
4	
5	

6
 7
 8
 9
 10
 11
 12
 13
 14
 15 lsb

WORD NAME: Memory Percent Available

WORD ID:	T6-04	RANGE:	0 - 100
SOURCE:	R/R	ACCURACY:	N/A
DESTINATION:	BC	lsb:	N/A
XMIT RATE	Periodic		
SIGNAL TYPE	Discrete		
UNITS	N/A		

BIT NO.		DESCRIPTION
0	msb	Bit 0 - 15 is the unsigned integer percent of unused (available) storage capacity from 0 to 100 (0 = full, 100 = empty)
1		
2		
3		
4		
5		
6		
7		
8		
9		
10		
11		
12		
13		
14		
15	lsb	

WORD NAME: Number of Files

WORD ID:	T6-05	RANGE:	0 - 512
SOURCE:	R/R	ACCURACY:	N/A
DESTINATION:	BC	lsb:	N/A

XMIT RATE Periodic
 SIGNAL TYPE Discrete
 UNITS N/A

BIT NO.	DESCRIPTION
0 msb	Bit 0 - 15 is the unsigned integer number of files or zero if no RMM is mounted in the R/R
1	
2	
3	
4	
5	
6	
7	
8	
9	
10	
11	
12	
13	
14	
15 lsb	

WORD NAME System or Replay Time Word 1

WORD ID:	T6-06 or T6-10	RANGE:	N/A
SOURCE:	R/R	ACCURACY:	N/A
DESTINATION:	BC	lsb:	N/A
XMIT RATE	Periodic		
SIGNAL TYPE	Discrete		
UNITS	N/A		

BIT NO.	DESCRIPTION
0 msb	-----
1	Hex Digit #1 = Tens of seconds, binary 0 to 5
2	
3 lsb	-----
4 msb	-----
5	Hex Digit #2 = Units of seconds, binary 0 to 9
6	
7 lsb	-----
8 msb	-----
9	Hex Digit #3 = Hundreds of milliseconds, binary 0 to 9
10	

11	lsb	-----
12	msb	-----
13		Hex Digit #4 = Tens of milliseconds, binary 0 to 9
14		
15	lsb	-----

WORD NAME System or Replay Time Word 2

WORD ID:	T6-07 or T6-11	RANGE:	N/A
SOURCE:	R/R	ACCURACY:	N/A
DESTINATION:	BC	lsb:	N/A
XMIT RATE	Periodic		
SIGNAL TYPE	Discrete		
UNITS	N/A		

BIT NO.		DESCRIPTION
0	msb	-----
1		Hex Digit #1 = Tens of hours, binary 0 to 2 ¹
2		
3	lsb	-----
4	msb	-----
5		Hex Digit #2 = Units of hours, binary 0 to 9 ¹
6		
7	lsb	-----
8	msb	-----
9		Hex Digit #3 = Tens of minutes, binary 0 to 5
10		
11	lsb	-----
12	msb	-----
13		Hex Digit #4 = Units of minutes, binary 0 to 9
14		
15	lsb	-----

Note 1. Hex digit #1 and hex digit #2 (tens of hours and units of hours) must together be a decimal number from 00 to 23

WORD NAME System or Replay Time Word 3

WORD ID:	T6-08 or T6-12	RANGE:	N/A
SOURCE:	R/R	ACCURACY:	N/A
DESTINATION:	BC	lsb:	N/A
XMIT RATE	Periodic		
SIGNAL TYPE	Discrete		
UNITS	N/A		

BIT NO.		DESCRIPTION
0	msb	-----
1		Hex Digit #1 = Tens of months, binary 0 to 1 ¹
2		
3	lsb	-----
4	msb	-----
5		Hex Digit #2 = Units of months, binary 0 to 9 ¹
6		
7	lsb	-----
8	msb	-----
9		Hex Digit #3 = Tens of days, binary 0 to 3 ^{2,3}
10		
11	lsb	-----
12	msb	-----
13		Hex Digit #4 = Units of days, binary 0 to 9 ^{2,3}
14		
15	lsb	-----

Note 1. Hex digit #1 and hex digit #2 (tens of months and units of months) must together be a decimal number from 01 to 12

Note 2. Hex digit #3 and hex digit #4 (tens of days and units of days) must together be a decimal number from 01 to 31

Note 3. Hex digit #3 and hex digit #4 (tens of days and units of days) must together be a valid number of days in the month identified by hex digit #1 and hex digit #2. For example, month 06 may only have a maximum of 30 days.

WORD NAME	System or Replay Time Word 4		
WORD ID:	T6-09 or T6-13	RANGE:	N/A
SOURCE:	R/R	ACCURACY:	N/A
DESTINATION:	BC	lsb:	N/A
XMIT RATE	Periodic		
SIGNAL TYPE	Discrete		
UNITS	N/A		

BIT NO.		DESCRIPTION
0	msb	-----
1		Hex Digit #1 = Thousands of years, binary 0 to 2
2		
3	lsb	-----
4	msb	-----
5		Hex Digit #2 = Hundreds of years, binary 0 to 9

6		
7	lsb	-----
8	msb	-----
9		Hex Digit #3 = Tens of years, binary 0 to 9
10		
11	lsb	-----
12	msb	-----
13		Hex Digit #4 = Units of years, binary 0 to 9
14		
15	lsb	-----

WORD NAME: Number of BC Events

WORD ID:	T6-14	RANGE:	0 - 31
SOURCE:	R/R	ACCURACY:	N/A
DESTINATION:	BC	lsb:	N/A
XMIT RATE	Periodic		
SIGNAL TYPE	Discrete		
UNITS	N/A		

BIT NO.		DESCRIPTION
0	msb	Bit 0 - 15 is the unsigned integer number of defined BC events from 0 to 31
1		
2		
3		
4		
5		
6		
7		
8		
9		
10		
11		
12		
13		
14		
15	lsb	

WORD NAME: Firmware Version

WORD ID:	T6-15	RANGE:	N/A
SOURCE:	R/R	ACCURACY:	N/A
DESTINATION:	BC	lsb:	N/A

XMIT RATE Periodic
 SIGNAL TYPE Discrete
 UNITS N/A

BIT NO.	DESCRIPTION
0	msb Bit 0 - 7 is the unsigned integer firmware version (major) number Bit 0 is msb, Bit 7 is lsb
1	
2	
3	
4	
5	
6	
7	
8	Bit 8 - 15 is the unsigned integer firmware revision (minor) number Bit 8 is msb, Bit 15 is lsb
9	
10	
11	
12	
13	
14	
15	
15	lsb

WORD NAME: TMATS File Revision

WORD ID:	T6-16	RANGE:	N/A
SOURCE:	R/R	ACCURACY:	N/A
DESTINATION:	BC	lsb:	N/A
XMIT RATE	Periodic		
SIGNAL TYPE	Discrete		
UNITS	N/A		

BIT NO.	DESCRIPTION
0	msb Bit 0 - 15 is the unsigned integer TMATS file revision number
1	
2	
3	
4	
5	
6	
7	
8	
9	
10	

11
12
13
14
15 lsb

A.3. Command Acceptability and Validity

After boot-up, the R/R is always operating in one of the states defined herein. The current state of the R/R is returned in the STATUS transmit command. The acceptability (receive) and validity (transmit) of each of the commands are defined in [Table A-3](#) as follows.

- A Always acceptable (receive) or valid (transmit)
- 1 Only acceptable when an volume is mounted in the R/R
- 2 INFO (transmit) validity is identified by the validity bits in word 1 and word 10. STATUS validity is identified by the validity bit in word 1.
- 3 The R/R time will only be updated by the TIME command when the Time Channel synchronization status as indicated by the HEALTH command Time Channel status word (Health command data word 2 bit 11) is “synchronization failure.”
- 4 Applies to Stop Command with Stop Replay option only when Play Live Data is active
- 5 Applies to Replay Command with Play Live option only when Play Live Data is not active
- N Never acceptable (receive) or valid (transmit)

When the R/R receives an invalid command, it will remain in its current state and only set the “Last Receive Command Error” bit in the STATUS command transmit message (T6-01 bit 11).

Table A-3. Military Standard 1553 Command Acceptability and Validity

Command	State												
	BIT	BUSY	COMMAND ERROR	DECLASSIFY	DECLASSIFY ERROR	DECLASSIFY PASS	ERASE	FAIL	IDLE	PLAY	QUEUE (FIND)	RECORD	RECORD & PLAY
ASSIGN	N	A	A	A	A	A	A	A	A	A	A	A	A
BIT	N	N	A	N	A	A	N	A	A	N	N	N	N
DECLASSIFY	N	N	1	N	1	1	N	1	1	N	N	N	N
ERASE	N	N	1	N	1	1	N	1	1	N	N	N	N
EVENT (RECV)	N	A	A	N	A	A	N	A	A	A	A	A	A

EVENTS (XMIT)	A	A	A	A	A	A	A	A	A	A	A	A	A
HEALTH	A	A	A	A	A	A	A	A	A	A	A	A	A
INFO (RECV)	N	A	A	A	A	A	A	A	A	A	A	A	A
INFO (XMIT)	2	2	2	2	2	2	2	2	2	2	2	2	2
PAUSE	N	A	A	A	A	A	A	A	A	A	A	A	A
QUEUE	N	1	1	N	1	1	N	1	1	N	N	1	N
RECORD	N	1	1	N	1	1	N	1	1	1	1	N	N
REPLAY	N	1	1	N	1	1	N	1	5	5	N	1	5
RESET	A	A	A	A	A	A	A	A	A	A	A	A	A
RESUME	N	A	A	A	A	A	A	A	A	A	A	A	A
STATUS	2	2	2	2	2	2	2	2	2	2	2	2	2
STOP	N	N	N	N	N	N	N	N	4	A	N	A	A
SYNC	A	A	A	A	A	A	A	A	A	A	A	A	A
TIME	N	3	3	3	3	3	3	3	3	3	3	3	3

This page intentionally left blank.

APPENDIX 6-B

Definitions

Broadcasting: Transmits live or recorded Chapter 10 data packets over an Ethernet interface using UDP as specified by Section 10.3 of [Chapter 10](#).

Channel: A path for an electrical signal interface to or from an R/R. Data transported into or out of an R/R on a channel are not in Chapter 10 packets.

Command processor: The functional part of an R/R that accepts operational commands into its single command sequence.

Command sequence: A single sequence of Chapter 6 commands as defined in this standard.

C&C: Abbreviation for command and control of an R/R and includes status reporting and monitoring of the R/R.

Downloading: Transfers data from the drive attached to and controlled by an R/R to a host computer system.

Drive: An electronic or electro-mechanical drive interface used to transfer data to or from a single data storage device, such as a flash disk, rotating disk, CD, or DVD. Supports a single fixed or removable recording medium.

Feature: A data input or output channel, a packet input or output port, a drive, or the R/R itself. The Chapter 6 health monitoring system described below reports information about each feature.

File: A sequence of Chapter 10 packets stored on a storage device IAW the requirements of [Chapter 10](#).

Looping: An operation in which the signals connected to the input channels are reproduced on the output channels of the R/R. During looping the same time base is used to receive and subsequently transmit one or more data streams.

Circuit-looping: Mode of operation where data is moved from the input channels directly to the output channels with minimum latency between data reception and data transmission.

Drive-looping: Mode of operation where received data is first written to one or more drives and subsequently read back from the drive. Drive-looping may or may not include a fixed or programmable delay between the time data is written to and read from drive.

Health attribute: Each feature of an R/R has one or more status words that are monitored through the health reporting system described in this standard.

Mandatory (M): Required capability is the minimum necessary for Major Range and Test Facility Base (MRTFB) interoperability. Units that do not meet required capability are not compliant.

Optional (O): Optional requirements are not mandated by the standard and are not necessary for MRTFB interoperability.

Port: A control and/or data electrical interface to an R/R. Data transported into or out of an R/R on a port is wrapped in Chapter 10 packets.

Pull-mode: An operational mode where the rate at which data is received and processed is determined and controlled by the processing algorithm. A pull-mode operation typically reads previously recorded data from a drive device at the rate it establishes and can support.

Push-mode: An operational mode where the rate at which the data, usually live, is received and processed is not determined or controllable by the processing algorithm. A push-mode algorithm must “keep up” with the data or drop-outs will occur.

R/R: Recorder and/or reproducer that supports a single command sequence.

Read-after-write: An operation in which the same time base is used to write data to one or more drives while simultaneously reading all or a subset of the written data from the same drives. Read-after-write is synonymous with drive-looping. Read-after-write can be used to verify accuracy of the stored data. Data recorded erroneously can then be rewritten at another location.

Read-while-write: An operation in which separate time bases are used to write data to one or more drives while simultaneously reading all or a subset of the written data from the same drives from random locations.

Recorder Configuration File: Defines the structures and their relationships within the R/R and to configure the R/R for a specific operational scenario. The recorder configuration file contains the payload of the Chapter 10 computer-generated data packet, Format 1 setup record that is recorded as the first packet of each compliant Chapter 10 data file.

Recording: Writes live push-mode data to one or more recording drives.

Recording drive: A recording medium is a physical unit of data storage, such as a flash disk, card, DVD, or CD. Recording drives may or may not be removable from the support electronics that connect them to an R/R. A removable drive is referred to as RMM in [Chapter 10](#).

Reproducing: Retrieves previously recorded data from one or more drives and outputs the data in its original or modified format.

Stream (or Channel ID Group): The set or a named subset of compliant Chapter 10 packets produced within an R/R. A single stream may contain either live or recorded packets, but not both. The default stream is the set of packets produced by any enabled data input channel in the applicable recorder configuration file. A named stream may be the packets from any or a defined subset of enabled input channels in the applicable configuration.

Uploading: Transfers data from a host computer system into the drive controlled by an R/R.

Volume: A logical unit of data storage IAW [Chapter 10](#). Each volume must have at least one compliant directory block and zero or more compliant data files. A single drive may contain one or more volumes (see [Chapter 10](#), Subsection 10.5.1).

APPENDIX 6-C

Citations

National Institute of Standards and Technology. “Secure Hash Standard (SHS).” FIPS PUB 180-4. August 2015. May be superseded by update. Retrieved 3 July 2019. Available at <http://nvlpubs.nist.gov/nistpubs/FIPS/NIST.FIPS.180-4.pdf>.

****** END OF CHAPTER 6 ******